



Multipole connectors

---

20

20

---

---

## **DISCLAIMER**

The information provided in this Catalogue is valid at the date of publication.  
Updated information may be available online at <https://www.ilme.com>:

- Q checking the relevant section of ILME website for latest release of this Catalogue;
  - Q consulting the specific online product data sheet;
  - Q checking the latest Certifications available for download.
-



## THE TRADITION OF INNOVATION SINCE 1945

ILME designs and manufactures complete solutions for industrial connections.

Headquartered in Milan and with subsidiaries in the key countries driving the progress of automation, ILME is an industry leader in the main world markets.

People are vital to success and growth at ILME, sharing a passion for innovation, utmost responsibility and participation.

The Company is committed to developing technology in the areas that most impact the future of the industries it serves: original solutions and safe wiring, research on the most suitable materials, rapid turnaround and readily available services while striving for energy saving and environmental safeguard.

## COMMITMENT TO INDUSTRY

Technological innovation is the main pillar of ILME competitiveness.

In the electrical connection sector of industrial automation, characterized by the need for top performance and reliability, ILME is an acknowledged leader with its own patents and a global benchmark supplier of major companies worldwide.

ILME offers a fully integrated range of high-quality products and services for every type of connection to suit any application requirements.



**AUTOMATION**



**RAILWAY**



**ENERGY**



**MARINE**



**FOOD  
& BEVERAGE**



**AGRONOMY**



**OUTDOOR**



**HEAVY VEHICLES**



**LIGHT  
& SOUND**



**PLASTICS**



**CHEMICAL**



**AIRPORT**

# IMPORTANT NOTES

- 1 ILME designs and manufactures complete solutions for Heavy Duty electrical power connections. The connector (although offered to the user as a variety of elements, usually inserts and enclosures, to allow the selection of the ideal combination) has been **designed as a complete connector** and tested to be compliant with the essential safety requirements of the EU Low Voltage Directive 2006/95/EC (2014/35/EU from April 20, 2016) and in particular the EN 61984 standard. The design of this “whole” system guarantees that every allowed combination of inserts, enclosures and accessories cannot result as improper.

---

- 2 The products in this catalogue alone cannot guarantee the best functionality upon installation, as this depends also on their correct **“putting into service”** which must be performed in compliance with the applicable system safety standards and according to the “rule of the art”. Therefore the effectiveness of the installation of the connector depends on the choices of the end user who must also take into account the following safety requirements.

---

- 3 Connectors must **not be connected or disconnected when live or under load**.

---

- 4 After wiring the inserts it is necessary to **verify the continuity of the protective earth connections**.

---

- 5 The **correct coupling of the inserts** is guaranteed only if they are installed (with the four fixing screws supplied \*) inside the corresponding enclosures or onto compatible accessories in this catalogue. ILME S.p.A. is not responsible for any different application.

---

- 6 Wiring of **screw-type terminal connections** must be carried out applying the correct tightening torque in order to avoid false contacts or damage to the conductor, the screw or the terminal.

---

- 7 **Crimping tools** and **crimp contacts** used should preferably be supplied by the same manufacturer to avoid difficulties with the insertion and retention or damaging of the contacts themselves.

---

- 8 Correct wiring of **spring-clamp connection inserts** is guaranteed only when the correct screwdriver indicated in the specific catalogue, or possibly on the insert, is used \*\*.

---

- 9 Avoid forcing the contacts during **connection and disconnection**. Connectors must be coupled and uncoupled in the axial direction with respect to the contacts, without bending and pulling the attached conductor bundles or cables.

---

- 10 Installation of two **inserts side by side**, in enclosures with two bays, must respect the polarity drawing marked on the insert (or the contact side view, as shown in this catalogue) to avoid inverted coupling.

---

- 11 Installation of two or more identical **connectors side by side** is recommended only with the use of **coding pins** in order to avoid mismatched couplings.

---

- 12 In order to keep the declared **degree of protection** (IP code according to EN 60529, or Enclosure Type Rating according to ANSI/UL 50E), enclosures must be completed with cable glands and/or other accessories with at least an equal degree of protection.

---

- 13 Moreover, the declared **degree of protection** (IP code according to EN 60529, or Enclosure Type Rating according to ANSI/UL 50E) is guaranteed when the enclosures, complete with inserts, are coupled and locked with their locking levers (or devices).

---

- 14 Connector inserts and their enclosures are generally compatible with similar/equivalent products from other manufacturers, according to the last samples tested. Full compatibility cannot be guaranteed in the event of technical changes made by other manufacturers. In particular, maximum performance of IP68 enclosures (CG Series) cannot be guaranteed when coupled with other manufacturers’ products.

---

- 15 **Spare parts** are supplied in minimum quantities only with the purpose to replace damaged parts. To avoid invalidation of warranty, products should be modified or repaired only by ILME: the integrity of their functionality - e.g. their degree of protection - can no longer be guaranteed if products are modified/repared by end-users. In any case, the liability for correct choice, assembly and use is totally at charge of the installer and the end-user.

---

- 16 ILME S.p.A. takes no responsibility in verifying whether the components herein contained comply with any specific regulations of fields of application.

---

- 17 ILME cannot be held responsible for individual components in **uses other than those described in this catalogue**. ILME cannot be held responsible for **incorrect connector selection** in relation to the environmental conditions of the application (e.g.: influence of ambient temperature, moisture, environmental pollution, etc.).

\* Except one fixing screw for size “21.21” inserts, two fixing screws for size “32.13” inserts.

\*\* Except for **SQUICH®** inserts (with spring-clamp terminals with actuator button) that do not require any tool to operate the terminal.

## CE MARKING

As from 1<sup>st</sup> January 1997, in order to make available electrical products on the European market, the manufacturer must ensure that these bear the relevant **CE marking**, in line with the Low Voltage Directive 73/23/EEC\* (implemented in Italy as L. D. 18-10-1977 no. 791) and its modification 93/68/EEC\* (implemented in Italy as L.D. 25-11-1996 no. 626/96, published in the supplement to the Gazzetta Ufficiale of 14-12-1996).

The CE marking must be visible on the product or, if this is not possible, on the packaging, the instructions for use or on the warranty certificate. It acts as a declaration by the manufacturer that the product complies with all relevant EU directives regarding its field of application.

### **ILME products bear the CE marking on the actual product or its packaging.**

Almost all ILME products fall within the scope of the Low Voltage Directive. An EU declaration of conformity is required in order to be able to apply the CE marking. This declaration, to which the market is not directly entitled, must be made available to the controlling authorities (in Italy, the Ministry of Economic Development) at all times. In it, the manufacturer declares the technical safety standard(s) followed in the design and manufacture of the product. These standards must be, in decreasing order of preference:

- a European standard (EN prefix)
- a European harmonisation document (HD prefix)
- an international IEC standard
- a national standard
- in the absence of reference standards, the manufacturer's internal specifications guaranteeing compliance with the basic safety requirements of the directive.

Conformity with harmonised technical standards (i.e. ratified by CENELEC) also constitutes presumption of conformity with the basic safety requirements of the directives.

The CE marking of ILME products results from the declaration of conformity of the product to harmonised standards or international IEC standards.

Through the CE marking, ILME declares full compliance, not merely with the directive's basic safety requirements, but also with those international or national standards on which voluntary safety certification markings are based (e.g. IMQ and VDE). In this way, ILME intends to give the CE marking the value of self-certification in terms of safety, given the loss in legal value of voluntary certifications issued by third parties, ratified by directive 93/68/EEC\*.

Notwithstanding the above, practically all ILME products still bear voluntary conformity markings.

The above mentioned EU declaration of conformity becomes null and void when the assembly of products includes one or more components not manufactured by ILME and without CE marking.

**▲ The information contained in this catalogue is not binding and may be changed without notice.**

\* **Note:** The subsequent legal reference for the Low Voltage Directive was 2006/95/EC, as consolidation of the original Directive 73/23/EEC + Directive 93/68/EEC. On 29<sup>th</sup> March 2014, the Official Journal of the European Union published the new Low Voltage directive 2014/35/EU dd. 26<sup>th</sup> February 2014, a recast version of directive 2006/95/EC, which is in force since 20<sup>th</sup> April 2016.



UNI EN ISO 9001: 2015  
Design, manufacture and distribution  
of industrial electrical equipment (IAF 19)  
Certificate No. 50 100 11133



# 2020 PRODUCTS

## Inserts

14

### CQ4 SERIES COMBINED INSERT "21.21"

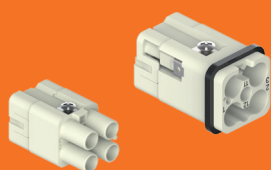

**CQ4F /M 03/2**  
Technical features

14  
15 - 17

### CX SERIES COMBINED INSERT

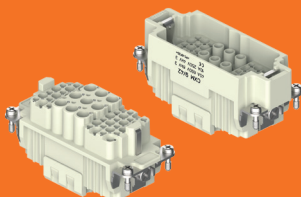

**CXF /M 9/42**  
Technical features

18  
19 - 21

## MIXO modular units

22

### MIXO SERIES

General Overview

22

### THE COMPLETE RANGE

24

### TECHNICAL CHARACTERISTICS

25

### MIXO NOVELTIES

26

MIXO series advantages

27

# MIXO modular units

## MIXO SERIES

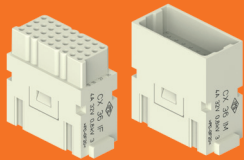

**CX 36 IF /IM**  
Technical features

28  
29 - 30

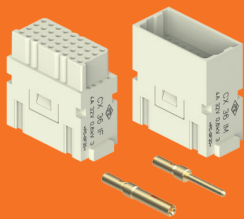

**CX 36 IF /IM**  
**HNM VERSION**

32

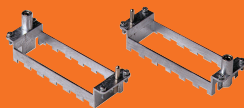

**HNM MIXO FRAMES**

33

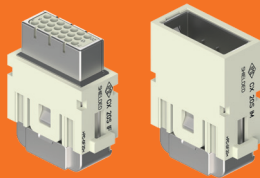

**CX 20S IF /IM**  
Technical features

34  
35 - 41

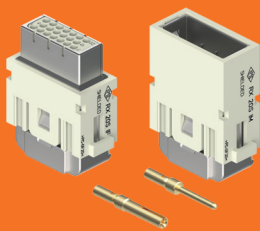

**RX 20S IF /IM**  
**HNM VERSION**

38

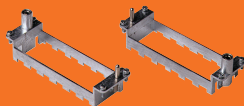

**HNM MIXO FRAMES**

39

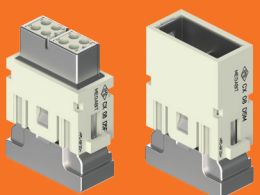

**MIXO MEGABIT**  
**CX 08 D5F /D5M, CX 08 D5F2 /D5M2**  
Technical features

42  
43 - 53

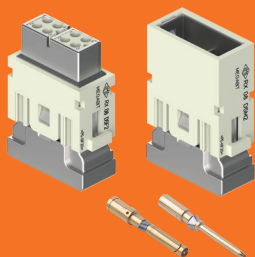

**RX 08 D5F /D5M,  
RX 08 D5F2 /D5M2  
HNM VERSION**

46 - 47

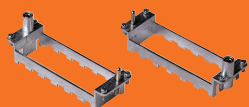

**HNM MIXO FRAMES**

48

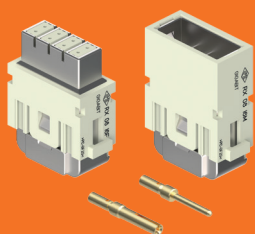

**MIXO GIGABIT RX 08 I6F /I6M  
HNM VERSION**

54

**HNM MIXO FRAMES**

55

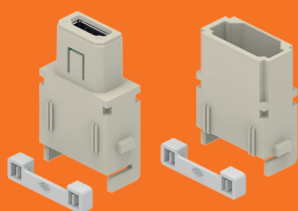

**MIXO HDMI MODULE  
CX 01 MIF /MIM  
PATCH CORD  
CW 2 MIAM /MIAF  
Technical features**

56  
57 - 59

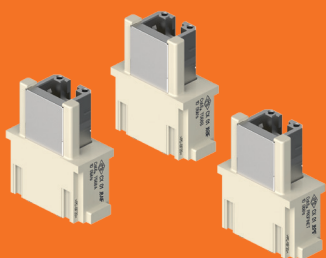

**MIXO RJ45 CAT. 6<sub>A</sub>  
CX 01 J8AIF /J8BIF /J8PIF  
Technical features**

60  
61 - 63

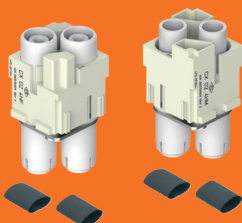

**MIXO HT MODULE 40 A 2 POLES  
CX 02 4HF /4HM  
Technical features**

64  
65 - 67

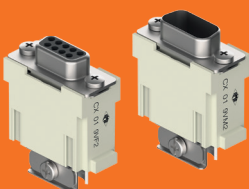

**MIXO 9-POLE SHIELDED  
CX 01 9VF2 /9VM2  
Technical features**

68  
69 - 71

# Contacts

72

## CRIMP CONTACTS



**CI SERIES CRIMP CONTACTS (5 A)**  
**BASIC GOLD PLATING**  
**HIGH THICKNESS GOLD PLATING**  
CIF2D /CIM2D 0.2/0.3/0.5/0.7  
CIFJD /CIMJD 0.2/0.3/0.5/0.7  
Technical features

72  
73 - 75

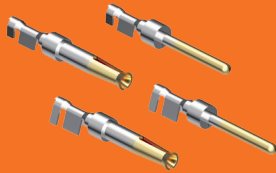

**SI SERIES STAMPED**  
**CRIMP CONTACTS (5 A)**  
SIF..D /SIM..D  
Technical features

76  
77 - 79



**RI SERIES HNM**  
**CRIMP CONTACTS (5 A)**  
RIFD /MD  
Technical features

80  
81 - 83



**CX7 SERIES SIZE 6.0**  
**CRIMP CONTACTS**  
CX7FA /MA 6.0  
Technical features

84  
85 - 87



## PCB Adapters

88

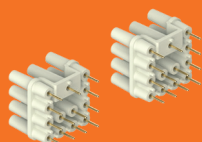

PCB INTERFACE ADAPTER  
FOR CQ 12 CIF INSERTS  
CIF Q12 2.4

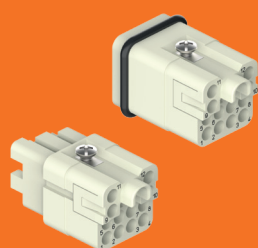

SPECIAL CQ 12 INSERTS  
FOR PCB ADAPTERS  
CQF 12 CIF /CQM 12 CIF  
Technical features

88  
89 - 91



PCB INTERFACE ADAPTER  
FOR CQ 07 INSERTS  
CIF Q07 2.4  
Technical features

92  
93 - 95

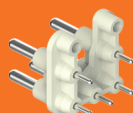

PCB INTERFACE ADAPTER  
FOR CQ 05 INSERTS  
CIF Q05 2.4  
Technical features

96  
97 - 99

## Accessories

100

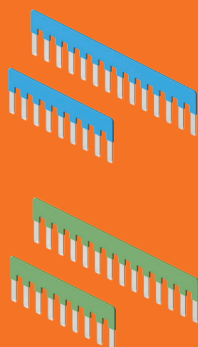

PARALLEL BRIDGES  
CR BDSH  
FOR CDSH-SQUICH®  
CONNECTOR INSERTS  
Technical features

100  
101 - 105

## Enclosures

106

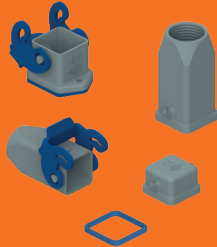

**CKH - MKH  
HYGIENIC ENCLOSURES  
SIZE "21.21"**  
Technical features

106  
107 - 115

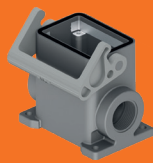

**T-TYPE ENCLOSURES  
WITH INTEGRATED PROTECTIVE  
EARTH JUMPERS**  
Technical features

116  
117



**BIG HOODS  
WITH INTEGRATED SPECIAL  
SELF-CENTRING  
FLOATING FRAME**  
Technical features

118  
119 - 123

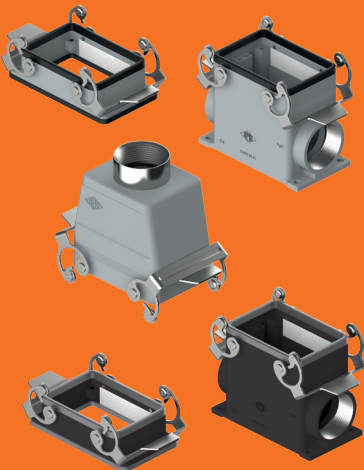

**SIZE "66.40" ENCLOSURES  
WITH FULL METAL LOCKING  
LEVERS**  
Technical features

124  
125 - 131

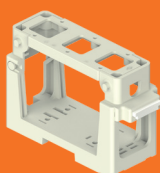

**COB SUPPORT FOR "21.21" INSERTS  
FOR DIN RAIL MOUNT**  
Technical features

132  
133 - 135

## Boxes

136



**T-BOX**  
**T-JUNCTION BOX**  
**FOR "21.21" INSERTS**  
Technical features

136  
137 - 139

## Crimping tools

140



Technical features

141 - 145

## Part numbers index

152

---

**CQ4 SERIES COMBINED INSERT “21.21”**  
**CQ4F /M 03/2**

---



**CQ4 Series - Combined insert “21.21”**  
**3 poles + ⊕ power: 40 A 400 V 6 kV 3**  
**2 poles auxiliary: 10 A 250 V 4 kV 3**



Find more  
information on  
our products at  
[www.ilme.com](http://www.ilme.com)

## TECHNICAL FEATURES

### CQ4F /M 03/2

- Proprietary design, in the same space of the currently available CQ4 03, it features two additional auxiliary contacts plus one (optional) coding pin.
- Combined insert size "21.21" (first ever) for use with 4 (3P + ⊕) removable crimp contacts series **CX** up to size **6.0** (6 mm<sup>2</sup> / 10 AWG) for power and 2 removable crimp contacts series **CD** up to size **2.5** (2,5 mm<sup>2</sup> / 14 AWG) for auxiliaries.
- Suitable to drive a 1-axis power motion control system (feeding the 3Φ AC motor of the axis) with its 2-pole braking circuit, while the encoder signals are served by a separate second connector, for ease of shielding against interferences typical of PWM variable frequency drivers.
- One optional coding pin, **CR Q03/2** (red colour), to realize 4 different codings and avoid mismatching in case of installation of up to four similar connectors nearby.
- EN/IEC 61984 ratings:
  - 3P + ⊕ power: **40 A 400 V 6 kV 3**
  - 2P auxiliary: **10 A 250 V 4 kV 3**
- Lower and Upper Limiting Temperatures (LLT ... ULT):  
-40 °C ... +125 °C.
- Max diameter of wire sheathing:
  - **5,0 mm** for 3P + ⊕ 40 A power contacts,
  - **3,8 mm** for 2P 10 A auxiliary contacts.

original  
proprietary design  
for high density  
combination of  
power and brakes  
contacts

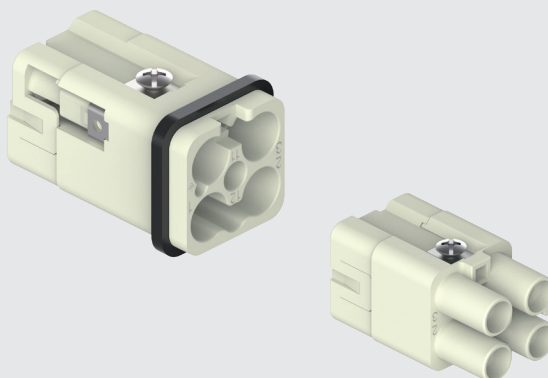

# CQ4F / M 03/2 combined "21.21" 3 poles + ⊕ (40 A - 400 V) + 2 poles (10 A - 250 V)

enclosures:  
size "21.21"

pages:

Insulating type	339 - 348
Metallic type	349 - 363
W-TYPE for aggressive environments	512 - 518
EMC	564 - 572
IP68	628 - 631
E-Xtreme® corrosion proof	538 - 539
<b>HYGIENIC CKH-MKH</b>	<b>108-114*</b>

- cannot be used in angled enclosures other than IA4/IAP25/AP25 and hoods other than V25/VN25/VG25

refer to CN.19 pages  
\* refer to NEWS 2020 pages

inserts, crimp connections

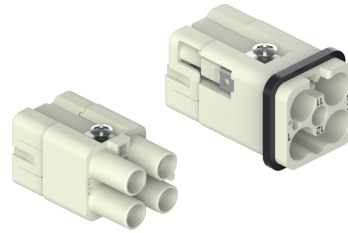

40 A and 10 A crimp contacts  
silver plated

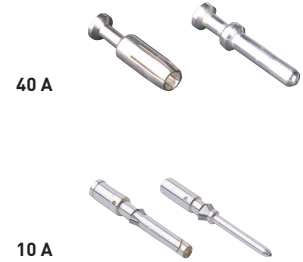

description

part No.

part No.

without contacts (to be ordered separately), including PE female inserts for female contacts  
male inserts for male contacts

**CQ4F 03/2**  
**CQ4M 03/2**

40 A female crimp contacts

1,5 mm <sup>2</sup>	AWG 16
2,5 mm <sup>2</sup>	AWG 14
4 mm <sup>2</sup>	AWG 12
6 mm <sup>2</sup>	AWG 10

**CXFA 1.5**  
**CXFA 2.5**  
**CXFA 4.0**  
**CXFA 6.0**

40 A male crimp contacts

1,5 mm <sup>2</sup>	AWG 16
2,5 mm <sup>2</sup>	AWG 14
4 mm <sup>2</sup>	AWG 12
6 mm <sup>2</sup>	AWG 10

**CXMA 1.5**  
**CXMA 2.5**  
**CXMA 4.0**  
**CXMA 6.0**

10 A female crimp contacts

0,14-0,37 mm <sup>2</sup>	AWG 26-22	identification No. 1
0,5 mm <sup>2</sup>	AWG 20	identification No. 2
0,75 mm <sup>2</sup>	AWG 18	identification No. ②
1 mm <sup>2</sup>	AWG 18	identification No. 3
1,5 mm <sup>2</sup>	AWG 16	identification No. 4
2,5 mm <sup>2</sup>	AWG 14	identification No. 5

**CDFA 0.3**  
**CDFA 0.5**  
**CDFA 0.7**  
**CDFA 1.0**  
**CDFA 1.5**  
**CDFA 2.5**

10 A male crimp contacts

0,14-0,37 mm <sup>2</sup>	AWG 26-22	identification No. 1
0,5 mm <sup>2</sup>	AWG 20	identification No. 2
0,75 mm <sup>2</sup>	AWG 18	identification No. ②
1 mm <sup>2</sup>	AWG 18	identification No. 3
1,5 mm <sup>2</sup>	AWG 16	identification No. 4
2,5 mm <sup>2</sup>	AWG 14	identification No. 5

**CDMA 0.3**  
**CDMA 0.5**  
**CDMA 0.7**  
**CDMA 1.0**  
**CDMA 1.5**  
**CDMA 2.5**

silver plated

- characteristics according to EN/IEC 61984 ratings:

**40 A 400 V 6 kV 3**  
**10 A 250 V 4 kV 3**

- cULus (ECBT2.E115072, ECBT8.E115072), (PVVA2.E506437, PVVA8.E506437) certified

- BV pending
- rated voltage according to UL/CSA: 600 V
- insulation resistance: ≥ 10 GΩ
- Lower and Upper Limiting Temperatures (LLT ... ULT): -40 °C ... +125 °C
- made of self-extinguishing thermoplastic resin UL 94V-0
- mechanical life: ≥ 500 cycles
- contact resistance: ≤ 0,3 mΩ (CX power contacts)  
≤ 3 mΩ (CD auxiliary contacts)

- it is recommended to crimp the contacts with crimping tools homologated by ILME (please see the crimping tool section 40A contacts CXF and CXM series and 10A contacts CDF, CDM series, on pages 708 - 741 of CN.19 catalogue). For 40 A contacts and 10 A contacts see also new pneumatic crimping tool CCPZP RN (see page 145)  
- for max. current load see the connector inserts derating diagram below.

**CQ4F / M 03/2 combined connector inserts**  
Maximum current load derating diagram

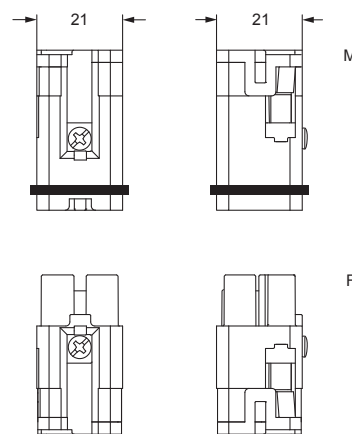
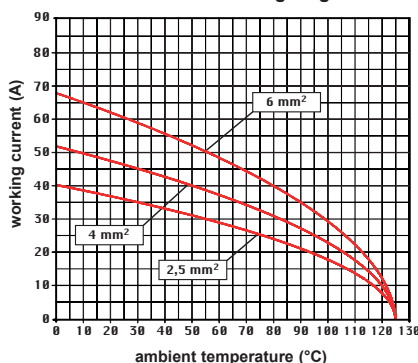

contacts side (front view)

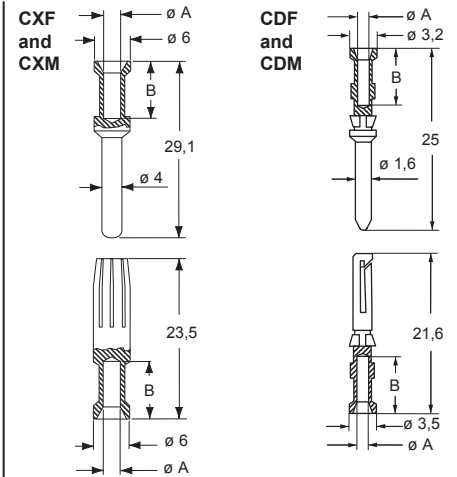

**CXF and CXM contacts**

conductor cross-sectional (mm <sup>2</sup> )	conductor slot ø A (mm)	conductor stripping length B (mm)
1,5	1,8	9
2,5	2,2	9
4	2,85	9,6
6	3,5	9,6

**CDF and CDM contacts**

0,14-0,37	0,9	8
0,5	1,1	8
0,75	1,3	8
1,0	1,45	8
1,5	1,8	8
2,5	2,2	6

coding pin for crimp inserts

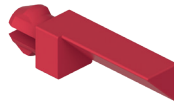

description

part No.

coding pin (optional) for CQ4 03/2 inserts

CR Q03/2

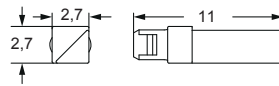

CR Q03/2 CODING OPTIONS



F

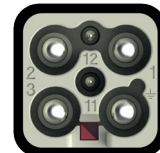

M



F



M



F

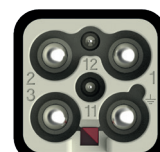

M



F

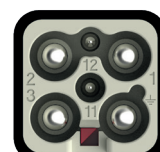

M

☑ Thanks to the use of the **optional CR Q03/2 coding pin** it is possible to achieve up to **4 different codings**.

---

## CX SERIES COMBINED INSERT

CXF /M 9/42

---

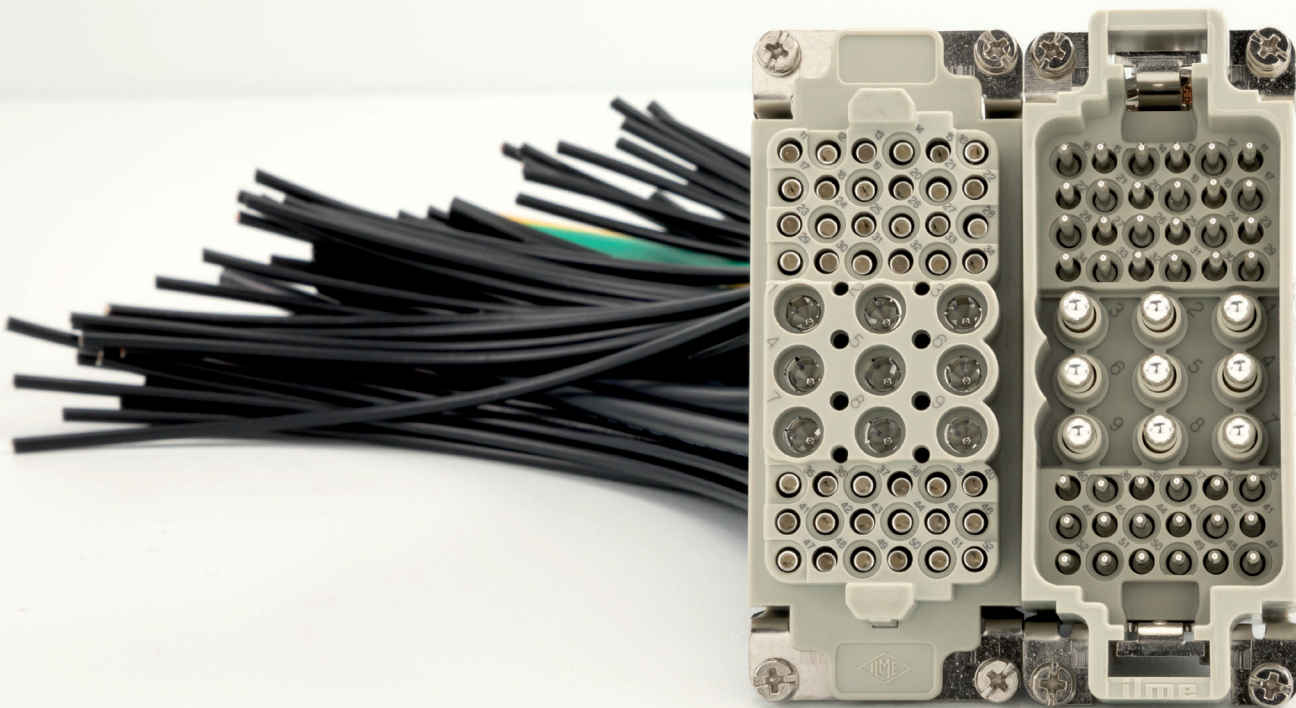

CX Series - Combined insert

9 poles core high power portion

40 A 690 V 8 kV 3

42 poles peripheral “mid power/auxiliary” portions

10 A 250 V 4 kV 3



Find more  
information on  
our products at  
[www.ilme.com](http://www.ilme.com)



## TECHNICAL FEATURES

### CXF /M 9/42

- Proprietary design, it expands the range of “power + auxiliaries” combined connector series.
- Combined connector for high power + mid power and a large number of signals and auxiliary circuits.
- EN/IEC 61984 ratings:
  - **40 A 690 V 8 kV 3**  
(core “high power” portion, 9 contact positions),
  - **10 A 250 V 4 kV 3**  
(peripheral “mid power/auxiliary” portions, 24+18=42 contact positions)
- Lower and Upper Limiting Temperatures (LLT ... ULT):  
-40 °C ... +125 °C.
- Suitable for removable crimp contacts series **CX** up to size **6.0** (6 mm<sup>2</sup> / 10 AWG) and series **CD** up to size **2.5** (2,5 mm<sup>2</sup> / 14 AWG).
- Covers up to three 3Φ AC motors (3 axes with high-power motion control system) and 24 + 18 = 42 poles in peripheral mid-power/auxiliaries sections, to cover e.g. 4 additional motion control axes with 12 of the 18-pole portion, and the remaining 30 contacts serving auxiliary and signal contacts (I/O, solenoids, etc.).
- Max diameter of wire sheathing:
  - **5,0 mm** in the 9P “high power” core portion,
  - **3,8 mm** in the 42P “mid-power/aux” peripheral portions.
- Matches the wiring of two separate cables in a single connector insert: one cable for powering motors and relevant braking circuits, the other cable for their encoder signals (position control).

proprietary design  
fulfilling minituarization  
trend in robotics: more  
power contacts and  
more auxiliary contacts  
in smaller size

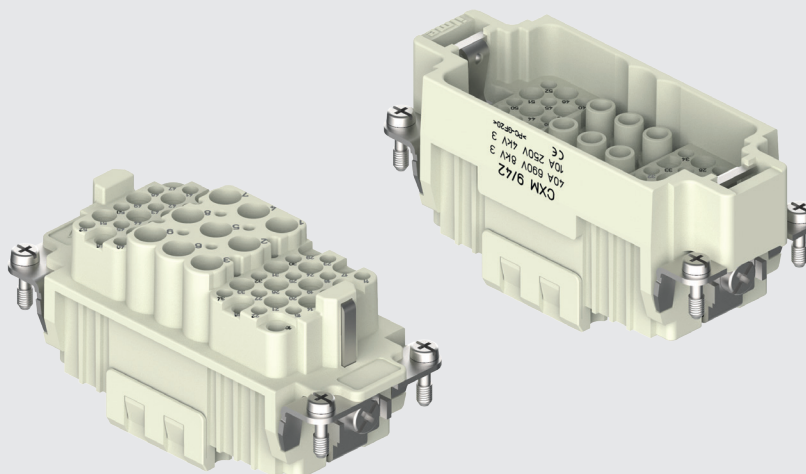

# CX Combined 9 poles (40 A - 690 V) + 42 poles (10 A - 250 V) + ⊕

**enclosures:**

size "77.27"

pages:

C-TYPE IP65/IP66	402 - 411
C7 IP67, two levers	439 - 440
V-TYPE IP65/IP66, single lever	454 - 458
BIG hoods	470 - 471
T-TYPE IP65 insulating	484 - 485
T-TYPE / W IP66/IP69 insulating	491
HYGIENIC T-TYPE / H IP66/IP69	503
HYGIENIC T-TYPE / C IP66/IP69, -50 °C	508
W-TYPE for aggressive environments	523
E-Xtreme® corrosion proof	534 - 535, 544, 554 - 555
EMC	580
Central lever	609 - 611
LS-TYPE	622 - 623
IP68	640 - 643

**panel supports:**

pages:

COB	652 - 653
-----	-----------

refer to CN.19 pages

**inserts, crimp connections**

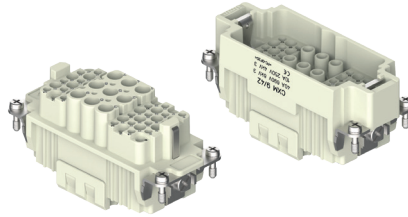

**40 A and 10 A crimp contacts silver and gold plated**



description	part No.	part No.	part No.
-------------	----------	----------	----------

without contacts (to be ordered separately)  
female inserts for female contacts  
male inserts for male contacts

CXF 9/42  
CXM 9/42

40 A female crimp contacts  
1,5 mm<sup>2</sup> AWG 16  
2,5 mm<sup>2</sup> AWG 14  
4 mm<sup>2</sup> AWG 12  
6 mm<sup>2</sup> AWG 10

CXFA 1.5  
CXFA 2.5  
CXFA 4.0  
CXFA 6.0

40 A male crimp contacts  
1,5 mm<sup>2</sup> AWG 16  
2,5 mm<sup>2</sup> AWG 14  
4 mm<sup>2</sup> AWG 12  
6 mm<sup>2</sup> AWG 10

CXMA 1.5  
CXMA 2.5  
CXMA 4.0  
CXMA 6.0

silver plated

\* for basic or high thickness gold plating, please refer to page 674 of CN.19 catalogue

10 A female contacts  
0,14-0,37 mm<sup>2</sup> AWG 26-22 identification No. 1  
0,5 mm<sup>2</sup> AWG 20 identification No. 2  
0,75 mm<sup>2</sup> AWG 18 identification No. ②  
1 mm<sup>2</sup> AWG 18 identification No. 3  
1,5 mm<sup>2</sup> AWG 16 identification No. 4  
2,5 mm<sup>2</sup> AWG 14 identification No. 5

CDFA 0.3  
CDFA 0.5  
CDFA 0.7  
CDFA 1.0  
CDFA 1.5  
CDFA 2.5

CDFD 0.3  
CDFD 0.5  
CDFD 0.7  
CDFD 1.0  
CDFD 1.5  
CDFD 2.5

gold plated\*

10 A male contacts  
0,14-0,37 mm<sup>2</sup> AWG 26-22 identification No. 1  
0,5 mm<sup>2</sup> AWG 20 identification No. 2  
0,75 mm<sup>2</sup> AWG 18 identification No. ②  
1 mm<sup>2</sup> AWG 18 identification No. 3  
1,5 mm<sup>2</sup> AWG 16 identification No. 4  
2,5 mm<sup>2</sup> AWG 14 identification No. 5

CDMA 0.3  
CDMA 0.5  
CDMA 0.7  
CDMA 1.0  
CDMA 1.5  
CDMA 2.5

CDMD 0.3  
CDMD 0.5  
CDMD 0.7  
CDMD 1.0  
CDMD 1.5  
CDMD 2.5

- characteristics according to EN/IEC 61984 ratings:

**40 A 690 V 8 kV 3**  
**10 A 250 V 4 kV 3**

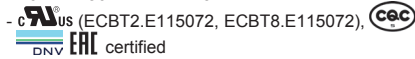

- BV pending
- rated voltage according to UL/CSA: 600 V
- insulation resistance: ≥ 10 GΩ
- Lower and Upper Limiting Temperatures (LLT ... ULT): -40 °C ... +125 °C
- made of self-extinguishing thermoplastic resin UL 94V-0
- mechanical life: ≥ 500 cycles
- contact resistance: ≤ 0,3 mΩ (CX power contacts) ≤ 3 mΩ (CD auxiliary contacts)

- it is recommended to crimp the contacts with crimping tools homologated by ILME (please see the crimping tool section 40A contacts CXF and CXM series and 10A contacts CDF, CDM series, on pages 708 - 741 of CN.19 catalogue).

For 40 A contacts and 10 A contacts see also new pneumatic crimping tool CCPZP RN (see page 145)  
- for max. current load see the connector inserts derating diagram below.

**CXF /M 9/42 combined connector inserts**  
**Maximum current load derating diagram**

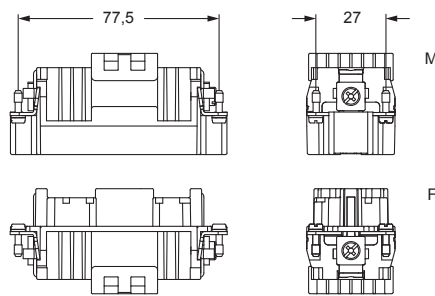
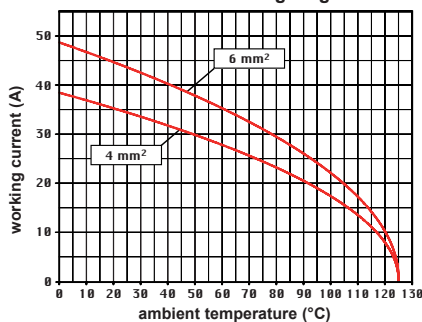

contacts side (front view)

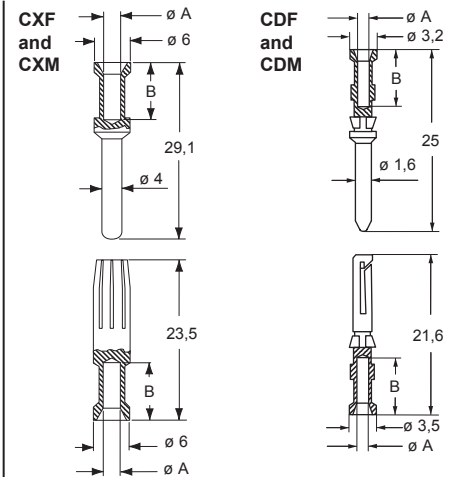
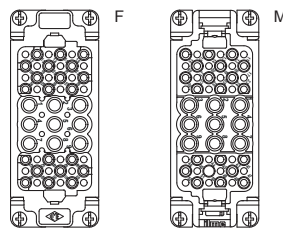

**CXF and CXM contacts**

conductor section mm <sup>2</sup>	conductor slot ø A (mm)	conductors stripping length B (mm)
1,5	1,8	9
2,5	2,2	9
4	2,85	9,6
6	3,5	9,6

**CDF and CDM contacts**

0,14-0,37	0,9	8
0,5	1,1	8
0,75	1,3	8
1,0	1,45	8
1,5	1,8	8
2,5	2,2	6

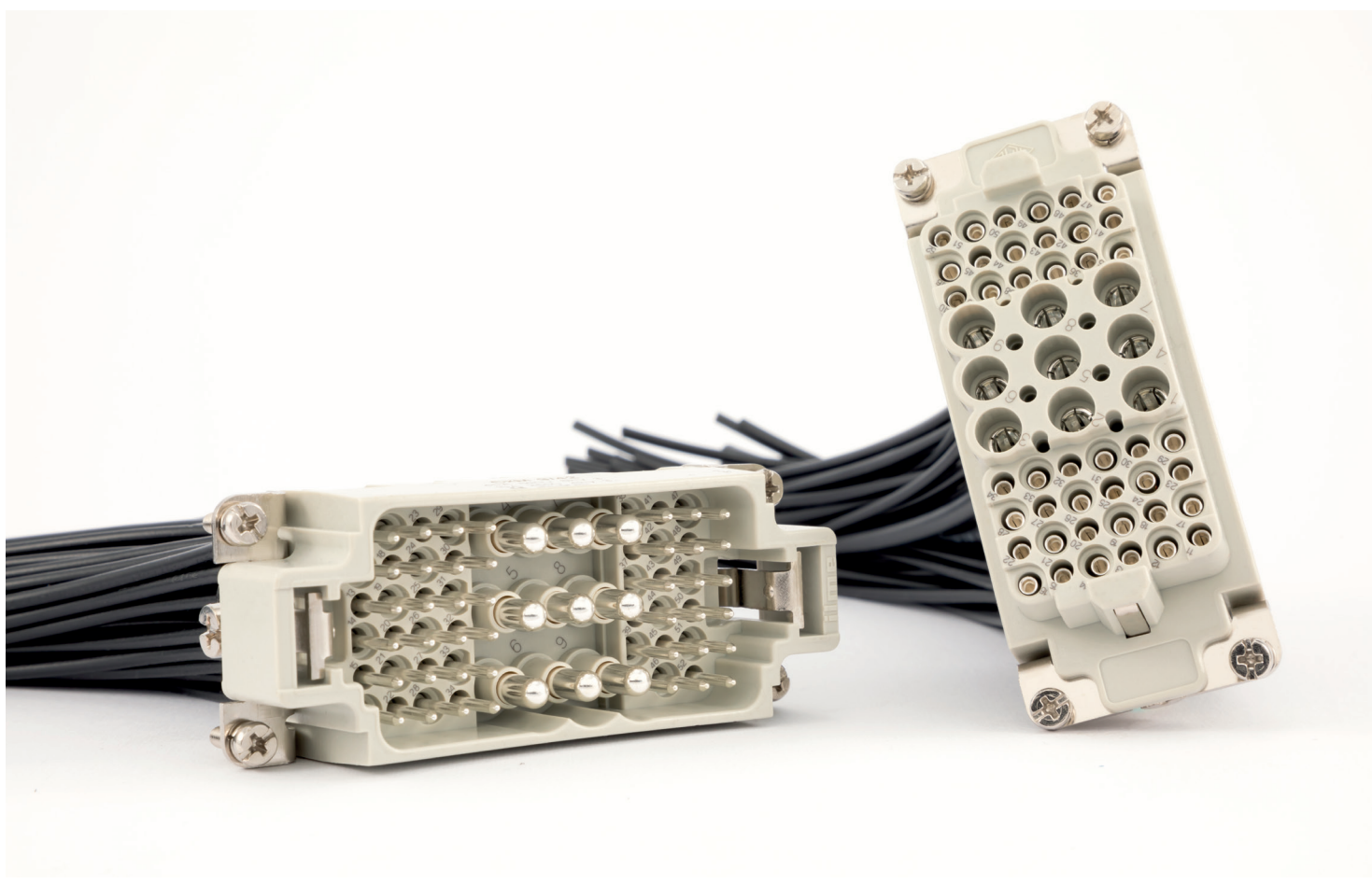
**CXF 9/42, CXM 9/42 COMBINED INSERT**

# MIXO SERIES

## GENERAL OVERVIEW

The MIXO series is a system of modular units for special applications that uses the traditional ILME enclosures. Each enclosure can house different types of connections such as: electric signals and contacts for the conduction of compressed air with pressure values of up to 8 bars.

The inserts are arranged side by side to form a single **compact block** which is inserted into metallic frames with constrained positioning. Once the modules have been inserted and locked with the special tabs, the connector can be placed into the enclosure.

The modular system makes it easy to access a series of contacts inserted in the frame (e.g., for substitution, check or the addition of signals with new inserts for needs not foreseen during the initial installation) without having to disassemble the entire connector.

ILME MIXO series of modular connectors is an open connector system that provides versatile configuration to the users' individual requirements, giving the **freedom to assemble a customized connector** from a range of over 50 modules for power electrical, data transmission, optical signals or air. The module range is continuously expanded, allowing new configurations to be realised.

The use of enclosures provides the possibility of innumerable **applications**.

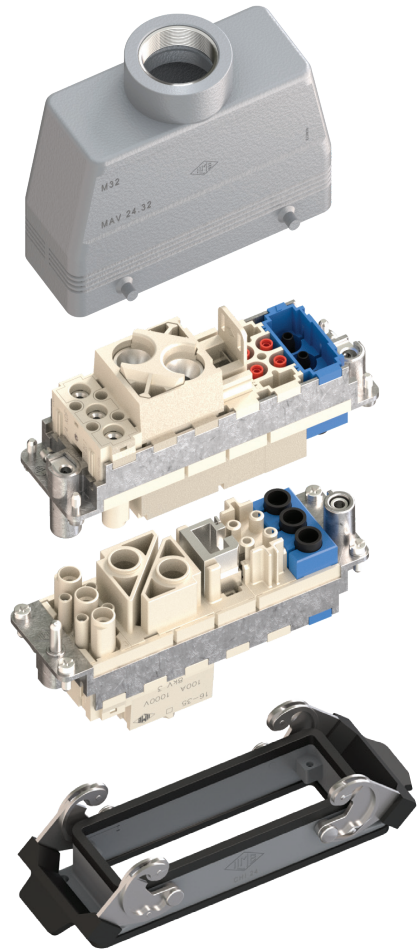

**POWER/  
SIGNAL**



**POWER**

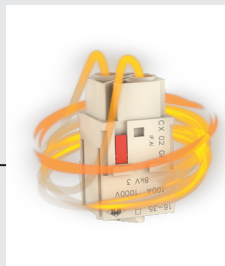

**DATA  
TRANSMISSION**



**FIBRE OPTIC**

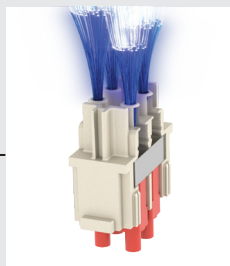

**PNEUMATIC**

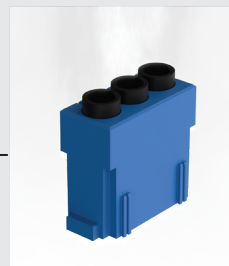

The MIXO series can be used with **5 different frame sizes:**

Frames	one or two-level metallic enclosures
<b>CX 01 T</b>	size "49.16"
<b>CX 02 TM/TF</b>	size "44.27"
<b>CX 03 TM/TF</b>	size "57.27"
<b>CX 04 TM/TF</b>	size "77.27"
<b>CX 06 TM/TF</b>	size "104.27"
<b>CX 04 TM/TF (x 2)</b>	size "77.62"
<b>CX 06 TM/TF (x 2)</b>	size "104.62"

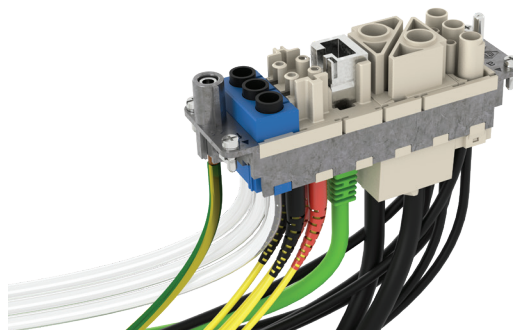

Single sized modules, where specified, can also be installed directly inside **MIXO ONE** enclosures.

**CX 01 T**  
1 module



**CX 02 TF/TM**  
2 modules

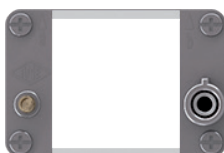

**CX 04 TF/TM**  
4 modules

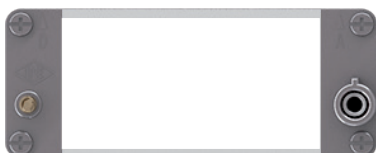

**CX 03 TF/TM**  
3 modules

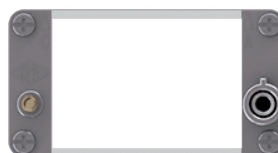

**CX 06 TF/TM**  
6 modules



Possibility – to be verified case-by-case – to use the recently added MIXO **HNM frames** (provided with special gold plated PE contacts) together with R series of crimp contacts and the relevant

connector hoods and housings, to produce, where required, an **HNM connector** (High Number of Matings, up to 10.000 cycles of operation).

Fill the unused frame slots with **CX FM dummy module**

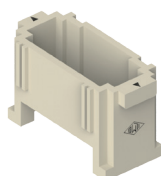

In addition, the MIXO series can be used with the **COB series panel supports**.

Frames	COB panel supports part No.
<b>CX 02 TM/TF</b>	fixed: <b>COB 06 BC</b> and <b>COB TCQ</b> mobile: <b>COB TSF, COB TSFS</b> and <b>COB 06 CMS</b>
<b>CX 03 TM/TF</b>	fixed: <b>COB 10 BC</b> and <b>COB TCQ</b> mobile: <b>COB TSF, COB TSFS</b> and <b>COB 10 CMS</b>

Frames	COB panel supports part No.
<b>CX 04 TM/TF</b>	fixed: <b>COB 16 BC</b> and <b>COB TCQ</b> mobile: <b>COB TSF, COB TSFS</b> and <b>COB 16 CMS</b>
<b>CX 06 TM/TF</b>	fixed: <b>COB 24 BC</b> and <b>COB TCQ</b> mobile: <b>COB TSF, COB TSFS</b> and <b>COB 24 CMS</b>



## THE COMPLETE RANGE

2020 products are marked with the **+** symbol.

Calculate the number of frame slots taken up by the required inserts (frame slot 1, 2 or 3 modules) and select the right frame according to the number of required modules (available 1, 2, 3, 4 and 6 modules).

Single sized modules, where specified, can also be installed directly inside **MIXO ONE** enclosures.

Inserts	Contact type	Signal type	Kind of connection	Rated current (A)	Rated voltage (V)	Number of frame slots
CX 01 YF/M	main	electric	crimp	200	1000	2
CX 01 YPEF/M	PE	—	crimp	200	—	2
CX 01 GF/M	main	electric	crimp	100	830	1
CX 02 GF/M	main	electric	crimp	100	1000	2
CX 02 7F/M	main	electric	crimp	70	1000	1
CX 02 4AF/M	main	electric	axial screw	40	1000	1
CX 02 4BF/M	main	electric	axial screw	40	1000	1
CX 02 4F/M	main	electric	crimp	40	1000	1
CX 03 4F/M	main	electric	crimp	40	400 / 690	1
CX 03 4BF/BM	main	electric	crimp	40	500	1
CX 3/4 XDF/M	main / auxiliary	electric	crimp	40 / 10	830	1
CX 04 XF/M	main	electric	crimp	40	830	1
CX 05 SF/M ▲	main	electric	spring	16	400	1
CX 05 SHF/M	main	electric	SQUICH®-spring	16	400	1
CX 06 CF/M	main	electric	crimp	16	500	1
CX 06P CF/M	main	electric	crimp	16	830	1
CX 08 CF/M	main	electric	crimp	16	400	1
CX 08 I6F/M	main + shield	electric	crimp	5	50	1
+ RX 08 I6F/M (HNM)	main + shield	electric	crimp	5	50	1
+ CX 08 D5F/F2 M/M2	main + shield	electric	crimp	10	50	1
+ RX 08 D5F/F2 M/M2 (HNM)	main + shield	electric	crimp	10	50	1
CX 20 CF/M	main	electric	crimp	16	500	2
CX 12 DF/M	main / auxiliary	electric	crimp	10	250	1
CX 17 DF/M	main / auxiliary	electric	crimp	10	160	1
CX 42 DF/M	main / auxiliary	electric	crimp	10	150	2
CX 25 IBF/M	main / auxiliary	electric	crimp	4	50	1
CX 25 IF/M ▲	main / auxiliary	electric	crimp	4	50	1
+ CX 20S IF/M	main / auxiliary + shield	electric	crimp	4	32	1
+ RX 20S IF/M (HNM)	main / auxiliary + shield	electric	crimp	4	32	1
+ CX 36 IF/M	main / auxiliary	electric	crimp	4	32	1
CX 02 CHF/M	main	electric	crimp	16	2500	1
CX 02 HF/M	main	electric	crimp	16	2900 / 5000	2
+ CX 02 4HF/M	main	electric	crimp	40	2900 / 5000	2
CX 02 BF/M	seat for two shielded connectors (refer to: CX 01 B, CX 01 BC, CX 04 B, CX 08 B)					2
CX 01 BCF/M	main / auxiliary + shield	electric	crimp	16	50	—
CX 01 BF/M	main / auxiliary + shield	electric	crimp	10	50	—
CX 04 BF/M	main / auxiliary + shield	electric	crimp	10	50	—
CX 08 BF/M	main / auxiliary + shield	electric	crimp	5	50	—
CX 03 P	pneumatic Ø 1,6 - 3,0 - 4,0 mm	air	push-in	—	—	1
CX 02 P	pneumatic Ø 6,0 mm	air	push-in	—	—	1
CX FM	none (dummy module)	—	—	—	—	1
CX 01 J8F/M/IM	RJ45	electric	crimp / IDC	—	—	1
+ CX 01 J8AIF/BIF/PIF	RJ45 + shield	electric	IDC	1	50	1
CX 01 JF/M	RJ45 + auxiliary	electric	crimp	10	250	2
CX 02 JF/M	RJ45 + auxiliary	electric	crimp	10	250	3
CX 01 UF/M	USB	electric	—	—	—	1
CX 01 9VF/M	D-SUB	electric	crimp	5	50	1
+ CX 01 9VF2/M2	D-SUB + shield	electric	crimp	5	50	1
CX 01 9VTF	D-SUB	electric	screw	5	50	1
+ CX 01 MIF/MIM	HDMI	electric	—	—	—	1
CX 04 LF/M	POF / MOST	optic	crimp	—	—	1
CX 04 RF/M	coaxial	electric	crimp	—	—	1
CX 04 SCF/M	SC fibre optic	optic	crimp / glue	—	—	1

▲ Available upon request



# TECHNICAL CHARACTERISTICS

- 1 Pneumatic contacts in plastic with hose barb connection.
- 2 Fibre optic contacts SC type.
- 3 Electric contacts in silver-plated or gold-plated brass with connections to the conductors via crimping, spring clamp or axial screw.
- 4 Modular inserts of identical size with insertion system for forming the complete module and frame lock tab.
- 5 Inserts in self-extinguishing thermoplastic material, reinforced with glass fibre, UL 94V-0 approved, with a working temperature range of -40 °C to +125 °C.
- 6 Inserts in conformance with the requirements of the EN 61984 standard and certified and marked with the UL, CSA, CQC, DNV, BV, EAC marks.
- 7 Inserts with patented "swallowtails" to prevent incorrect coupling.
- 8 Position of contacts identified with numbers or codes on both sides of every insert.
- 9 Male/female module carrier frames with mandatory housings and polarity, in die-cast zinc alloy.
- 10 Module lock tab, may be divided according to the number of modules used; it guarantees a perfect stability of the modules during wiring and coupling/uncoupling of the connectors.
- 11 Asymmetric protective earth contacts (two per frame) with wide contact surface to prevent incorrect coupling; when two or more identical connectors of the MIXO series are used, coded pins may prevent incorrect coupling.
- 12 Captive frame fastening screws, with spring washer.
- 13 Dummy module for unused frame slots.

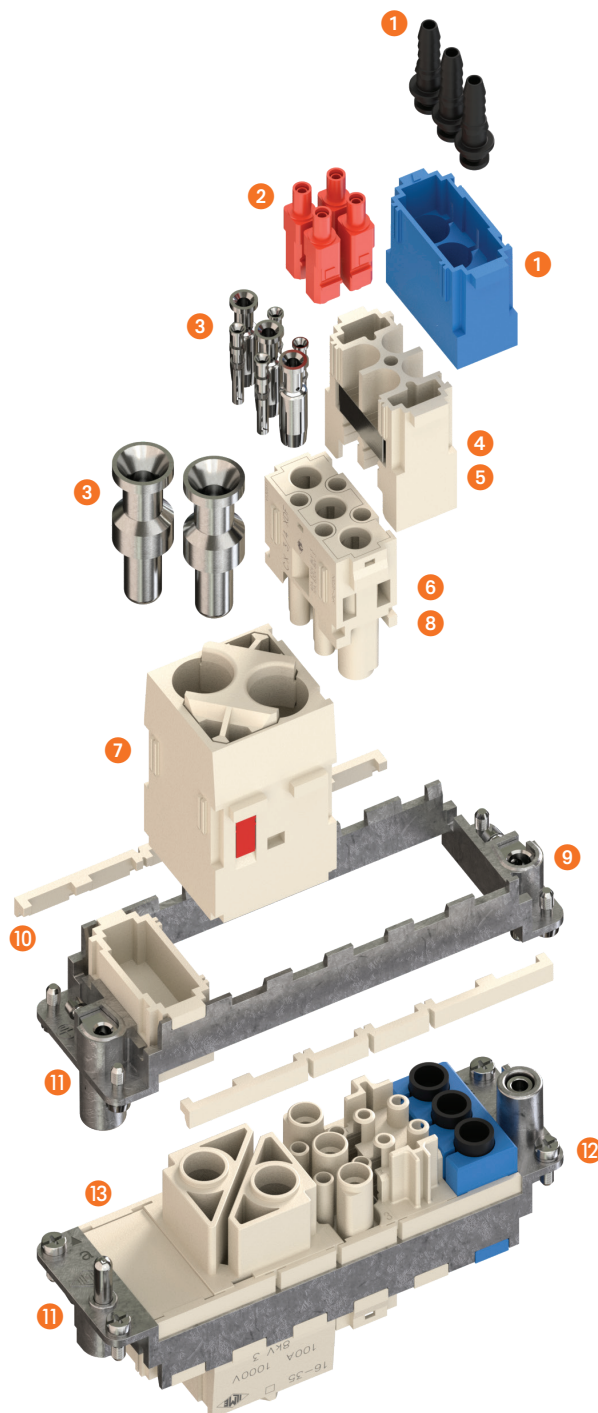

## ADVANTAGES

- ☑ Easy and user-friendly assembly of the complete multi-module insert before fixing it on the relevant sized metal frame;
- ☑ use of proprietary ILME technology providing each module with "swallowtails" (lateral keys/keyways), for reciprocal locking of modules and overall assembly of the insert into rigid (non hinged) frames with snap-in locking strips;
- ☑ faster and easier assembly compared with competitor solutions (easier handling of modules as a complete block than e.g. 6 independent parts);
- ☑ intermateability at "complete connector" (modules in frame) with other industry standard products;
- ☑ robust and long lasting prevailing crimp connection technology (largely preferred over screw type technology in high vibration and shock environments).



Watch  
our  
video

## MIXO NOVELTIES

The MIXO series, featuring a flexible modular design for utmost versatile connector creation with easy and safe installation, is again furtherly expanded, with the addition of 9 new modules (8 single-sized, 1 double-sized), widening the MIXO portfolio to 53 modules, as follows:

- **CX 36 IF /IM**  
**New MIXO 4 A module**  
 single-sized, 36 poles, 4 A (crimp) – 32 V 0,8 kV 3,  
 very high density
- **CX 20S IF /IM**  
**New MIXO Shielded 4 A module**  
 single-sized, 20 poles + shield, 4 A (crimp) – 32 V 0,8 kV 3
- **RX 20S IF /IM**  
**New MIXO HNM (High Number of Matings) Shielded 4 A module**  
 single-sized, 20 poles + shield, 4 A (crimp) – 32 V 0,8 kV 3
- **CX 08 D5F /M (one cable) and CX 08 D5F2 /M2 (two cables)**  
**New MIXO Megabit module**  
 single-sized, 8 poles + shield, 10 A (crimp) – 50 V 0,8 kV 3  
 with relevant accessories
- **RX 08 D5F /M (one cable) and CX 08 D5F2 /M2 (two cables)**  
**New MIXO HNM (High Number of Matings) Megabit module**  
 single-sized, 8 poles + shield, 10 A (crimp) – 50 V 0,8 kV 3  
 with relevant accessories
- **RX 08 I6F/M**  
**New MIXO HNM (High Number of Matings) Gigabit module**  
 single-sized, 8 poles + shield, 5 A (crimp) – 50 V 0,8 kV 3  
 for use with new RI turned crimp HNM contacts
- **CX 01 MIF /MIM**  
**New MIXO HDMI module**  
 single-sized, adapter (male) and coupler (female) for **HDMI**™ Type A  
 slim sized patch cords **CW 2 MIAF /MIAM** (2 m length) 0,5 A – 40 V 0,8 kV 3
- **CX 01 J8AIF /J8BIF /J8PIF**  
**New MIXO RJ45 Cat. 6<sub>A</sub> female module with IDC terminations**  
 single-sized, 8-way shielded RJ45 jack (female connector), with IDC terminations for 4-pair data cables,  
 Cat. 6<sub>A</sub> Class E<sub>A</sub>, for transmission rates up to 10 Gbit/s (IEEE 802.3an), 1 A – 50 V 0,8 kV 3
- **CX 02 4HF/4HM**  
**New MIXO HT module 40A 2 poles**  
 double-sized, 2 poles, 40 A (crimp) – 2900/5000 V 15 kV 3
- **CX 01 9VF2/9VM2**  
**New MIXO 9-pole shielded D-SUB module for 2 cables**  
 single-sized, 9-pole, 5A (crimp) – 50 V 0,8 kV 3 D-Sub shielded female connector module  
 for wiring to two separate cables (double cable clamp on the shield)



Find more  
 information on  
 our products at  
[www.ilme.com](http://www.ilme.com)



## MIXO SERIES ADVANTAGES

- Easy and user-friendly assembly of the complete multi-module insert before fixing it on the relevant sized metal frame;
- use of proprietary ILME technology providing each module with "swallowtail" lateral keys/keyways, for reciprocal locking of modules and overall assembly of the insert into rigid (non hinged) frames with snap-in locking strips;
- faster and easier assembly compared with competitor solutions (e.g. no need for additional, optional plastic stoppers to lock the hinge, no need for a hinged frame at all, easier handling of modules as a complete block than e.g. 6 independent parts);
- intermateability at "complete connector" (modules in frame) with other industry standard products;
- robust and long lasting prevailing crimp connection technology (largely preferred over screw type technology in high vibration and shock environments);
- possibility - to be verified case-by-case - to use the recently added MIXO HNM frames (provided with special gold plated PE contacts) together with crimp contacts R series and the relevant connector hoods and housings, to produce where required an HNM connector (High Number of Matings, up to 10.000 cycles of operation).

In addition, each of the new modules adds the following individual features:

- miniature-oriented, very high density, 40% higher than previously available for 5A crimp contacts (CX 36 IF/IM);
- robust shielding of larger number of connections (20) for sensitive signals against possible interference by adjacent power contacts used for variable frequency driving of motors (MIXO Shielded CX 20S IF/IM);
- fully shielded connections for two 4-way data bus cables in a single-sized module (miniaturizing trend) (MIXO Megabit module);
- HNM versions of Gigabit module and of new Megabit and Shielded modules, as well as of new CX 36 IF/IM 36 poles module, for use when these modules are foreseen for frequent operation;
- high quality video signal transmission (Ultra HD 4k@60 Hz) in the heavy-duty MIXO modular system (world premiere);
- alternative to the female/female RJ45 Cat 6A CX 01 J8F coupler module, for three different pin assignments (TIA 568A, TIA 568B and PROFINET) with IDC solderless connection (CX 01 J8...IF);
- high tension (2900/4000V) at higher current (40A) needs, widening the portfolio of MIXO HT modules for high tension applications (CX 02 4HF/4HM);
- more versatility at lower cost in serving data bus systems using the D-SUB 9-pole shielded connectors, with cable clamp for 2 shielded cables (CX 01 9VF2/9VM2).

## MIXO SERIES AT A GLANCE

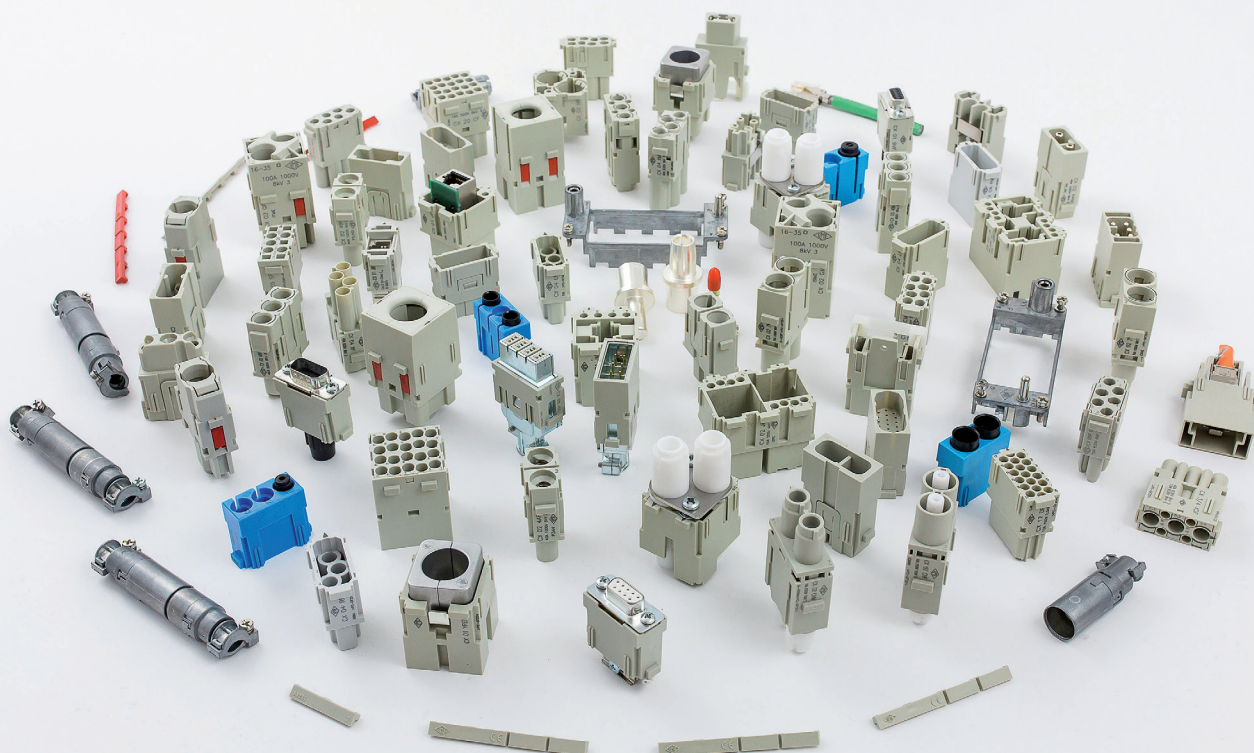

---

MIXO  
CX 36 IF /IM

---

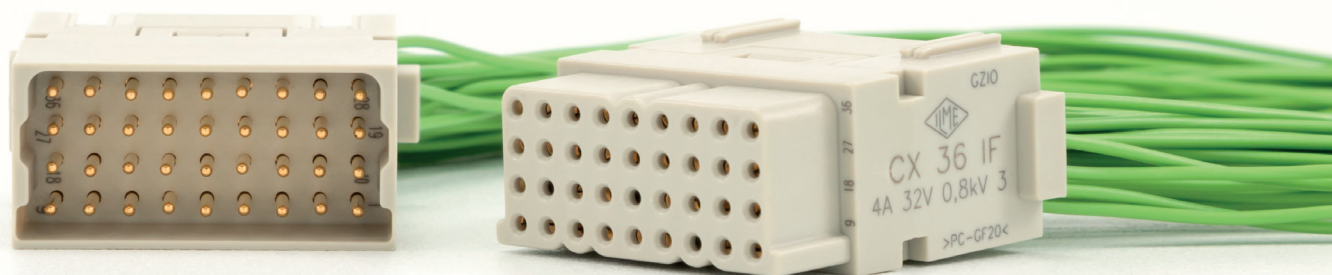

Very high density

MIXO 4 A 36-pole ELV (extra-low voltage) 32 V  
connector module for signal transmission,

EN/IEC 61984 ratings: 36 P 4 A 32 V 0,8 kV 3



Find more  
information on  
our products at  
[www.ilme.com](http://www.ilme.com)

## TECHNICAL FEATURES

### CX 36 IF /IM

- **Very high density** 36-pole ELV (extra-low voltage) 32 V connector module for signal transmission.
- 40% higher density than previously available CX 25 IF/IM or the improved CX 25 IBF /IBM for use of size 0.7 wires up to 18 AWG 0,75 mm<sup>2</sup>.
- EN/IEC 61984 ratings: **36 P 4 A 32 V 0,8 kV 3**  
NOTE – As a connector with extra-low voltage rating, it is out of the scope of the EU Low Voltage Directive 2014/35/EU and of the Russian equivalent Technical Regulation TR CU 004/2011, hence neither the C€ marking nor the EAC mark are applicable.
- UL/CSA voltage rating: 30 Vac/dc.
- Lower and Upper Limiting Temperatures (LLT ... ULT): -40 °C ... +125 °C.
- Suitable either for series CI turned crimp contacts sizes **0.2 - 0.3 - 0.5** (size 0.7 not suitable), available with standard gold plating (D), basic gold plating (JD - see page 72), silver plating (A), tin plating (S), or for new series SI stamped crimp contacts sizes 0.2 or 0.5 (gold plated, 3 performance levels: 1D - 2D - 3D).
- Max individual wire sheathing diameter: **1,7 mm**
- **HNM variant** is created using HNM turned crimp contacts series RI, for up to 10.000 mating cycles when mounted in HNM MIXO frames **RX 02 /03 /04 /06 TF /TM** (in turn mounted inside HNM connector enclosures), thanks to special lubrication on the shield contact spring.
- Suitable also for MIXO ONE enclosures.

40% higher density than previously available CX 25 IF /IM or CX 25 IBF /IBM



# CX 36 IF/IM 36 poles 4 A - 32 V

The modular inserts must be installed in suitable frames which are then mounted in traditional housings or in COB panel support. Single-sized modular units may be directly mounted inside MIXO ONE enclosures.

pages:

frames for modular units 317

MIXO ONE enclosures 369

refer to CN.19 pages

modular units, crimp connections

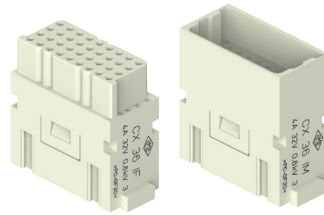

CI (4 A) crimp contacts, silver and gold plated



description	part No.	part No.	part No.
without contacts (to be ordered separately)			
female inserts for female contacts	<b>CX 36 IF</b>		
male inserts for male contacts	<b>CX 36 IM</b>		
CI (4 A) female crimp contacts			
0,08-0,21 mm <sup>2</sup> AWG 28-24		<b>CIFA 0.2</b>	<b>CIFD 0.2</b>
0,13-0,33 mm <sup>2</sup> AWG 26-22		<b>CIFA 0.3</b>	<b>CIFD 0.3</b>
0,33-0,52 mm <sup>2</sup> AWG 22-20		<b>CIFA 0.5</b>	<b>CIFD 0.5</b>
CI (4 A) male crimp contacts			
0,08-0,21 mm <sup>2</sup> AWG 28-24		<b>CIMA 0.2</b>	<b>CIMD 0.2</b>
0,13-0,33 mm <sup>2</sup> AWG 26-22		<b>CIMA 0.3</b>	<b>CIMD 0.3</b>
0,33-0,52 mm <sup>2</sup> AWG 22-20		<b>CIMA 0.5</b>	<b>CIMD 0.5</b>

- characteristics according to EN/IEC 61984 ratings: **4 A 32 V 0,8 kV 3**
- (ECBT2.E115072, ECBT8.E115072),
- certified
- BV pending
- rated voltage according to UL/CSA: 30 V
- insulation resistance: ≥ 10 GΩ
- Lower and Upper Limiting Temperatures (LLT ... ULT): -40 °C ... +125 °C
- made of self-extinguishing thermoplastic resin UL 94V-0
- mechanical life: ≥ 500 cycles
- contact resistance: ≤ 4 mΩ
- for crimp contacts CI series use: **CIPZ D** crimping tool
- **CIPZ D** pneumatic crimping tool (see page 144)
- **CITP D** turret head
- **CIES** insertion / removal tool for contacts 0,2 - 0,5 mm<sup>2</sup> (see pages 716 - 719 of CN.19 catalogue)
- for max. current load see the connector inserts derating diagrams **under construction**.

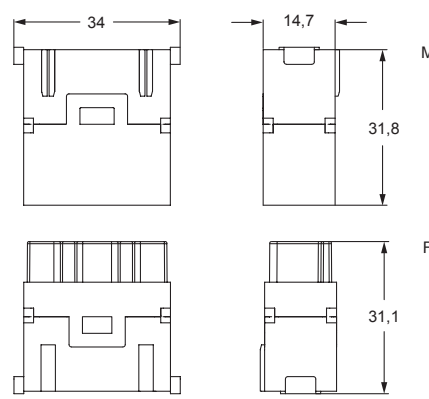

contacts side (front view)

side with reference arrow ▲

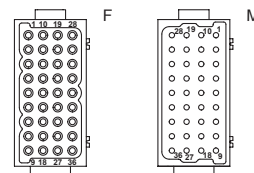

- 1 frame slot

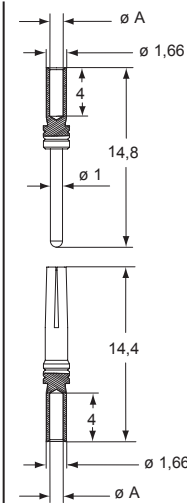

CIF and CIM contacts

conductor section (mm <sup>2</sup> )	conductor slot ø A (mm)	conductors stripping length (mm)
0,08-0,21	0,64	4
0,13-0,33	0,90	4
0,33-0,52	1,12	4

\* for basic or high thickness gold plating, please refer to page 74

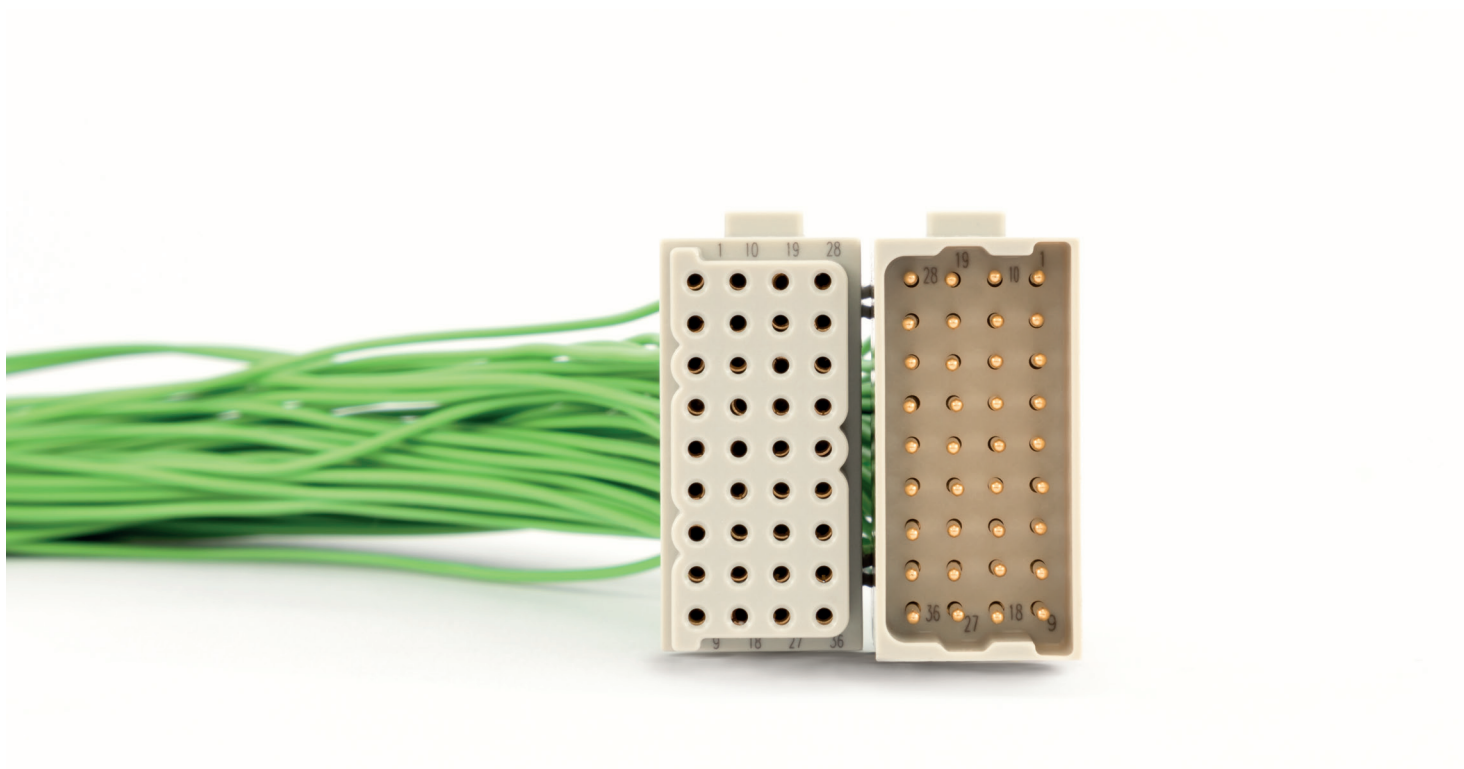
**MIXO CX 36 IF/IM**



The modular inserts must be installed in suitable frames which are then mounted in HNM enclosures.

modular units,  
crimp connections

RI (4 A) crimp contacts  
gold plated

page:  
frames for modular units 33

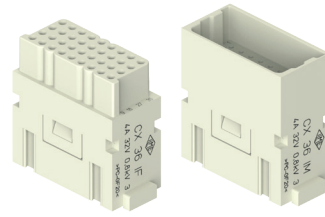

- Q 10.000 MATINGS WITH HNM FRAMES AND HNM ENCLOSURES**
- Q 5.000 MATINGS WITH HNM FRAMES AND STANDARD ENCLOSURES, SINGLE LEVER**

description	part No.	part No.
-------------	----------	----------

without contacts (to be ordered separately)  
female inserts for female contacts  
male inserts for male contacts

**CX 36 IF**  
**CX 36 IM**

RI (4 A) female crimp contacts  
0,08-0,21 mm<sup>2</sup> AWG 28-24  
0,13-0,33 mm<sup>2</sup> AWG 26-22  
0,33-0,52 mm<sup>2</sup> AWG 22-20

**RIFD 0.2**  
**RIFD 0.3**  
**RIFD 0.5**

RI (4 A) male crimp contacts  
0,08-0,21 mm<sup>2</sup> AWG 28-24  
0,13-0,33 mm<sup>2</sup> AWG 26-22  
0,33-0,52 mm<sup>2</sup> AWG 22-20

**RIMD 0.2**  
**RIMD 0.3**  
**RIMD 0.5**

gold plated

- characteristics according to EN/IEC 61984 ratings:  
**4 A 32 V 0,8 kV 3**
- (ECBT2.E115072, ECBT8.E115072),
- certified
- BV pending
- rated voltage according to UL/CSA: 30 V
- insulation resistance: ≥ 10 GΩ
- Lower and Upper Limiting Temperatures (LLT ... ULT):  
-40 °C ... +125 °C
- made of self-extinguishing thermoplastic resin  
UL 94V-0
- mechanical life: ≥ 10.000 cycles
- contact resistance: ≤ 4 mΩ
- for crimp contacts RI series use:  
**CIPZ D** crimping tool  
**CIPZP D** pneumatic crimping tool (see page 144)  
**CITP D** turret head  
**CIES** insertion / removal tool for contacts 0,2 - 0,5 mm<sup>2</sup>  
(see pages 716 - 719 of CN.19 catalogue)
- for max. current load see the connector inserts derating diagrams **under construction**.

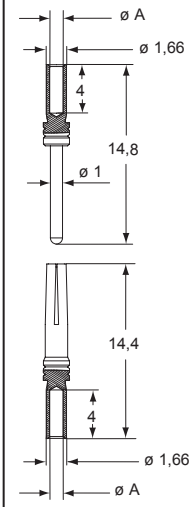
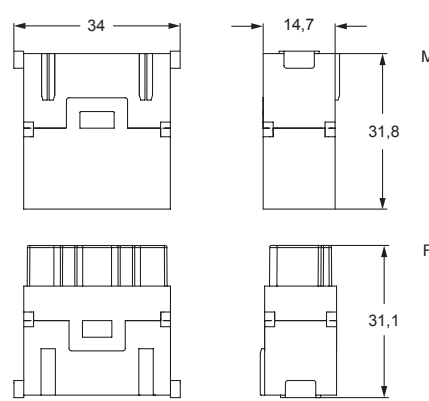

contacts side (front view)

side with reference arrow ▲

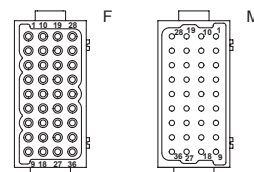

**RIF and RIM contacts**

conductor section (mm <sup>2</sup> )	conductor slot ø A (mm)	conductors stripping length (mm)
0,08-0,21	0,64	4
0,13-0,33	0,90	4
0,33-0,52	1,12	4

- 1 frame slot



enclosures size:		pages:
"44.27"	HNM	592 - 593
	C-TYPE IP65/IP66, single lever	387 - 392
	V-TYPE IP65/IP66, single lever	444 - 447
	E-Xtreme® corrosion proof	530-531, 542, 550-551
"57.27"	HNM	594 - 595
	C-TYPE IP65/IP66, single lever	393 - 401
	V-TYPE IP65/IP66, single lever	448 - 453
	E-Xtreme® corrosion proof	532-533, 543, 552-553
"77.27"	HNM	596 - 597
	C-TYPE IP65/IP66, single lever	402 - 411
	V-TYPE IP65/IP66, single lever	454 - 458
	E-Xtreme® corrosion proof	534-535, 544, 554-555
"104.27"	HNM	598 - 599
	C-TYPE IP65/IP66, single lever	412 - 423
	V-TYPE IP65/IP66, single lever	459 - 463
	E-Xtreme® corrosion proof	536-537, 545, 556-557
"77.62"	C-TYPE IP65/IP66, single lever	424 - 429
	E-Xtreme® corrosion proof	546
"104.62"	C-TYPE IP65/IP66, single lever	430
	E-Xtreme® corrosion proof	547

refer to CN.19 pages

frames for modular units with lock-in tab (included)

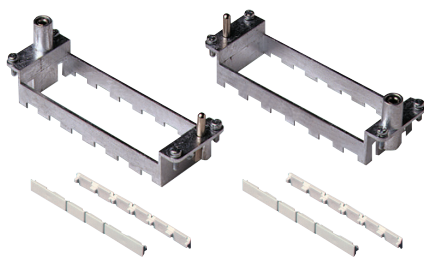

- Q 10.000 MATINGS WITH HNM FRAMES AND HNM ENCLOSURES
- Q 5.000 MATINGS WITH HNM FRAMES AND STANDARD ENCLOSURES, SINGLE LEVER

description	part No.	part No.
frames for modular units, with lock-in tab included	type for hoods*	type for housings*
for 2 modular units - for housing size 44.27	<b>RX 02 TM</b>	<b>RX 02 TF</b>
for 3 modular units - for housing size 57.27	<b>RX 03 TM</b>	<b>RX 03 TF</b>
for 4 modular units - for housing size 77.27 and 77.62	<b>RX 04 TM</b>	<b>RX 04 TF</b>
for 6 modular units - for housing size 104.27 and 104.62	<b>RX 06 TM</b>	<b>RX 06 TF</b>

C-TYPE and V-TYPE 2-lever versions cannot be used to reach 5.000 matings.

- die-cast zinc alloy frames
- protective earth (PE)
- possibility of mounting female and male modular units on the same frame
- frames supplied with lock-in tab to attach units
- polarisation on frames
- coding pins **CR..CX**
- for spare lock-in tab **CX CFM** see SPARE SPARTS catalogue

\* Assignment of attribute "for hoods" or "for housings" is merely conventional: both types can be mounted either in a hood or in a housing. In a modular connector coupling there shall be always a frame type "M" and a frame type "F".

RX TM / TF

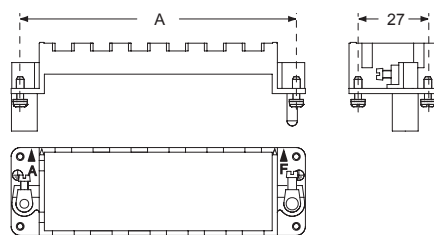

part No.	A (mm)	for housings size
<b>RX 02 TM / TF</b>	44	44.27
<b>RX 03 TM / TF</b>	57	57.27
<b>RX 04 TM / TF</b>	77,5	77.27 and 77.62
<b>RX 06 TM / TF</b>	104	104.27 and 104.62

Earth terminal

- large: for cables from 4-6 mm<sup>2</sup>, AWG 12-10
- small: for cables from 1-2,5 mm<sup>2</sup>, AWG 18-14

In order to accommodate larger PE conductor cross-sectional area, use CGT PE adapters, see page 319 CN.19 catalogue.

position of modules (contact side view)

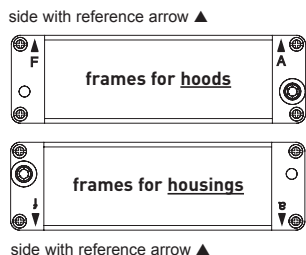

CX CFM (lock-in tab)

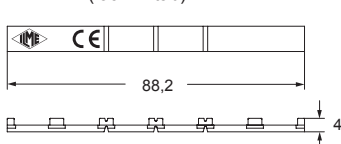

Polarisation of frames with relative identification letters and couplings

frame for hoods <sup>1)</sup> frames for housings <sup>1)</sup>

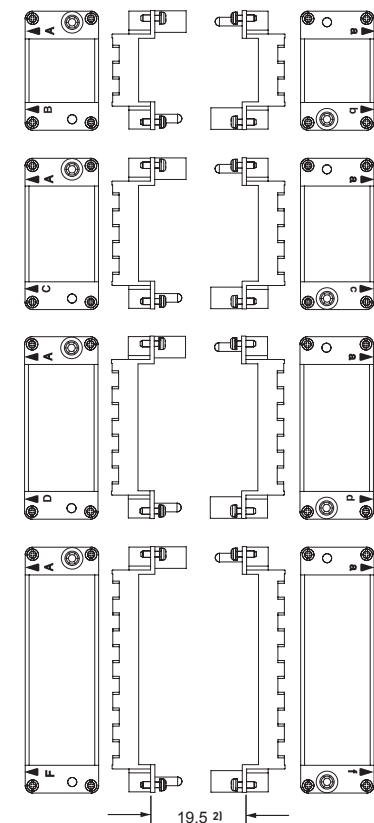

1) Warning:

- The module support frames are marked:
- FOR HOODS: **upper-case** A-B, A-C, A-D and A-F
- FOR HOUSINGS: **lower-case** a-b, a-c, a-d and a-f

Positioning the modules in the frames according to the respective letters is ensuring the specular assembly of modules, for which the hood will be coupled correctly to the housing.

2) Distance for:

- electric and fibre optic contacts: max 21 mm
- pneumatic contacts: max 20,5 mm

---

## MIXO SHIELDED CX 20S IF /IM

---



MIXO Shielded

20 poles + shield 4 A module,

EN/IEC 61984 ratings: 4 A 32 V 0,8 kV 3



Find more  
information on  
our products at  
[www.ilme.com](http://www.ilme.com)



## TECHNICAL FEATURES

### CX 20S IF /IM

- **Shielded** module for up to 20 turned crimp contacts series **CI** (5A) sizes 0.2 to 0.5, covering e.g. up to 10 signals.

- EN/IEC 61984 ratings: **4 A 32 V 0,8 kV 3**

NOTE – As a connector with extra-low voltage rating, it is out of the scope of the EU Low Voltage Directive 2014/35/EU and of the Russian equivalent Technical Regulation TR CU 004/2011, hence neither the C€ marking nor the EAC mark are applicable.

- Lower and Upper Limiting Temperatures (LLT ... ULT):  
-40 °C ... +85 °C.

- Max individual wire sheathing diameter: **1,9 mm**

- Protects sensitive signals against possible interference generated by adjacent power contacts, when used in combination with MIXO power modules (10A, 16A, 40A or more) whose wires belong to the same power/signal combined cable (fulfilling the robotics trend in reducing the number of cables).

- **Supplied already complete of module and shielded connector**, turned crimp contacts CI Series separately available for due choice of size **0.2, 0.3 or 0.5** (not suitable for size 0.7).

- Screw fixing **cable clamp** (single cable entry) required for cable screen connection to the module shield, is separately available in 4 different sizes according to the range of cable Ø in mm: 5/7 – 7/10 – 10/12 and 11/14 (new).

NOTE – Available upon request, as alternative to the screw fixing cable clamps, crimp flange and crimp sleeve cable clamps (same as applicable for the MIXO Gigabit module) to be chosen according to the specific dimension of the cable screen diameter and its insulation diameter (contact ILME Commercial Offices).

- HNM variant part nos. **RX 20S IF /IM** for use with HNM turned crimp contacts series **RI**, for up to 10.000 mating cycles when mounted in HNM MIXO frames **RX 02 /03 /04 /06 TF /TM** (in turn mounted inside HNM connector enclosures), thanks to special lubrication of the contact spring on the shield.

- **Shield separated from the PE circuit** (MIXO frame).  
NOTE – For versions with additional shielding connection to the MIXO frame (single earth/ground reference, preferred in railway rolling stock applications), part nos. **CX 20S IGF /IGM** contact ILME Commercial Offices.

- Suitable also for MIXO ONE enclosures.

all-around  
shielding separate  
from protective  
earth (grounding)  
potential



# CX 20S IF/IM 20 poles + shield 4 A module - 32 V

The modular inserts must be installed in suitable frames which are then mounted in traditional housings or in COB panel support. Single-sized modular units may be directly mounted inside MIXO ONE enclosures.

pages:

frames for modular units 317

MIXO ONE enclosures 369

- we recommend the use of CRF / CRM code pins together with relevant MIXO frame

refer to CN.19 pages

modular units, crimp connection

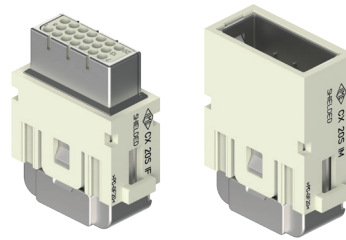

cable clamp

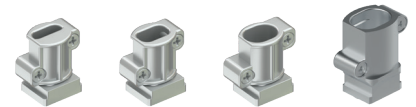

description

part No.

part No.

without contacts (to be ordered separately)  
female inserts for female contacts  
male inserts for male contacts

CX 20S IF  
CX 20S IM

cable clamp for 5-7 mm cable diameter  
cable clamp for 7-10 mm cable diameter  
cable clamp for 10-12 mm cable diameter  
cable clamp for 11-14 mm cable diameter

CX 5/7 CA  
CX 7/10 CA  
CX 10/12 CA  
CX 11/14 CA

- characteristics according to EN/IEC 61984 ratings:  
**4 A 32 V 0,8 kV 3**
- (ECBT2.E115072, ECBT8.E115072), certified
- DNV certified
- BV pending
- rated voltage according to UL/CSA: 32 V
- insulation resistance:  $\geq 10 \text{ G}\Omega$
- Lower and Upper Limiting Temperatures (LLT ... ULT):  
-40 °C ... +85 °C
- shield electrically separated from the PE of the frame
- made of self-extinguishing thermoplastic resin  
UL 94V-0
- mechanical life:  $\geq 500$  cycles
- contact resistance:  $\leq 4 \text{ m}\Omega$
- for crimp contacts CI series use:  
**CIPZ D** crimping tool  
**CIPZP D** pneumatic crimping tool (see page 144)  
**CITP D** turret head  
(see pages 716 - 719 of CN.19 catalogue)
- for max. current load see the connector inserts derating diagrams **under construction**.

CX 20S IF, CX 20S IM

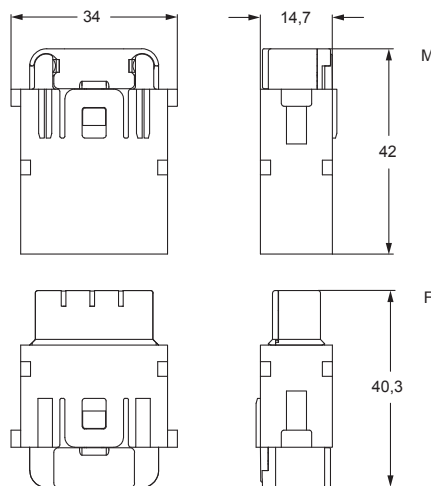

contacts side (front view)

side with reference arrow ▲

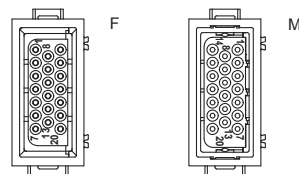

- 1 frame slot

CX 5/7 CA, CX 7/10 CA, CX 10/12 CA

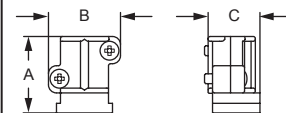

part No.	A	B	C
CX 5/7 CA	19,1	18	12,95
CX 7/10 CA	19,1	18	12,95
CX 10/12 CA	19,1	20,8	12,95

CX 11/14 CA

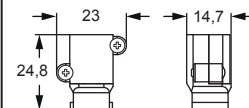

# CI 4 A Crimp contacts

## CI (4 A) crimp contacts gold plated



description

part No.

CI (4A) female crimp contacts  
0,08-0,21 mm<sup>2</sup> AWG 28-24  
0,13-0,33 mm<sup>2</sup> AWG 26-22  
0,33-0,52 mm<sup>2</sup> AWG 22-20

**CIFD 0.2**  
**CIFD 0.3**  
**CIFD 0.5**

gold plated+

CI (4A) male crimp contacts  
0,08-0,21 mm<sup>2</sup> AWG 28-24  
0,13-0,33 mm<sup>2</sup> AWG 26-22  
0,33-0,52 mm<sup>2</sup> AWG 22-20

**CIMD 0.2**  
**CIMD 0.3**  
**CIMD 0.5**

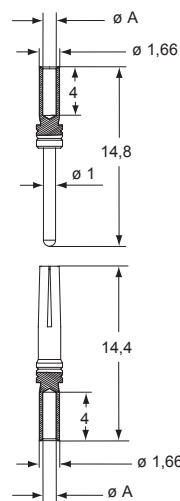

### CIF and CIM contacts

conductor section (mm <sup>2</sup> )	conductor slot ø A (mm)	conductors stripping length (mm)
0,08-0,21	0,64	4
0,13-0,33	0,90	4
0,33-0,52	1,12	4

+ for basic or high thickness gold plating, please refer to page 74

The modular inserts must be installed in suitable frames which are then mounted in HNM enclosures.

frames for modular units

page:

39

- we recommend the use of CRF / CRM code pins together with relevant MIXO frame

modular units,  
crimp connection

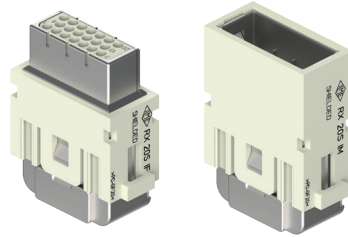

**Q 10.000 MATINGS WITH HNM FRAMES AND HNM ENCLOSURES**

**Q 5.000 MATINGS WITH HNM FRAMES AND STANDARD ENCLOSURES, SINGLE LEVER**

**FROM NOVEMBER 2020**

cable clamp

RI (4 A) crimp contacts, gold plated

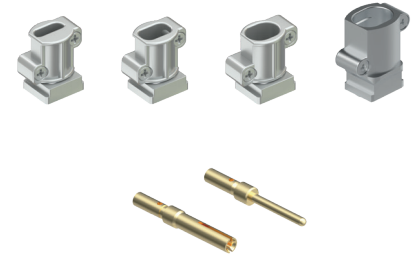

description

part No.

part No.

without contacts (to be ordered separately)  
female inserts for female contacts  
male inserts for male contacts

**RX 20S IF**  
**RX 20S IM**

cable clamp for 5-7 mm cable diameter  
cable clamp for 7-10 mm cable diameter  
cable clamp for 10-12 mm cable diameter  
cable clamp for 11-14 mm cable diameter

**CX 5/7 CA**  
**CX 7/10 CA**  
**CX 10/12 CA**  
**CX 11/14 CA**

RI (4A) female crimp contacts  
0,08-0,21 mm<sup>2</sup> AWG 28-24  
0,13-0,33 mm<sup>2</sup> AWG 26-22  
0,33-0,52 mm<sup>2</sup> AWG 22-20

**RIFD 0.2**  
**RIFD 0.3**  
**RIFD 0.5**

gold plated

RI (4A) male crimp contacts  
0,08-0,21 mm<sup>2</sup> AWG 28-24  
0,13-0,33 mm<sup>2</sup> AWG 26-22  
0,33-0,52 mm<sup>2</sup> AWG 22-20

**RIMD 0.2**  
**RIMD 0.3**  
**RIMD 0.5**

- characteristics according to EN/IEC 61984 ratings:

**4 A 32 V 0,8 kV 3**

- (ECBT2.E115072, ECBT8.E115072),

- certified

- BV pending

- rated voltage according to UL/CSA: 32 V

- insulation resistance:  $\geq 10 \text{ G}\Omega$

- Lower and Upper Limiting Temperatures (LLT ... ULT):

-40 °C ... +85 °C

- shield electrically separated from the PE of the frame

- made of self-extinguishing thermoplastic resin

UL 94V-0

- mechanical life:  $\geq 10.000$  cycles

- contact resistance:  $\leq 4 \text{ m}\Omega$

- for crimp contacts RI series use:

**CIPZ D** crimping tool

**CIPZP D** pneumatic crimping tool (see page 144)

**CITP D** turret head

(see pages 716 - 719 of CN.19 catalogue)

- for max. current load see the connector inserts derating diagrams **under construction**.

**RX 20S IF, RX 20S IM**

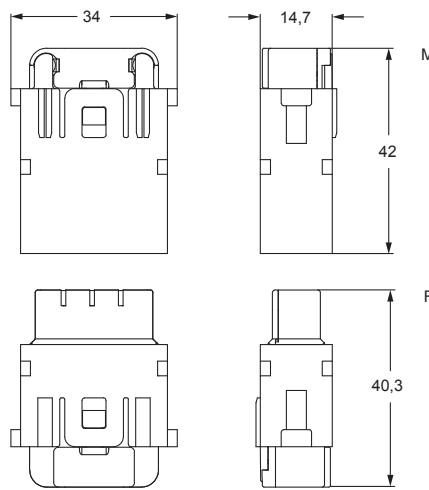

contacts side (front view)

side with reference arrow ▲

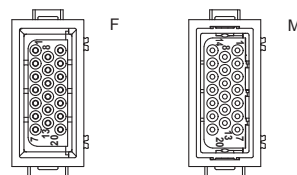

- 1 frame slot

**CX 5/7 CA, CX 7/10 CA, CX 10/12 CA**

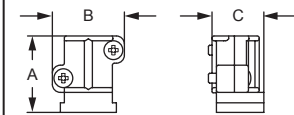

part No.	A	B	C
<b>CX 5/7 CA</b>	19,1	18	12,95
<b>CX 7/10 CA</b>	19,1	18	12,95
<b>CX 10/12 CA</b>	19,1	20,8	12,95

**CX 11/14 CA**

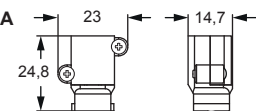

**RIF and RIM**

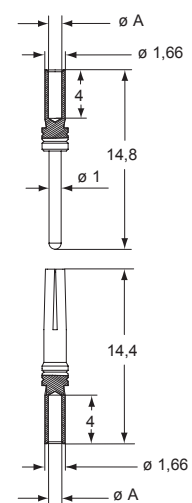

**RIF and RIM contacts**

conductor section (mm <sup>2</sup> )	conductor slot ø A (mm)	conductors stripping length (mm)
0,08-0,21	0,64	4
0,13-0,33	0,90	4
0,33-0,52	1,12	4



enclosures size:		pages:
"44.27"	HNM	592 - 593
	C-TYPE IP65/IP66, single lever	387 - 392
	V-TYPE IP65/IP66, single lever	444 - 447
	E-Xtreme® corrosion proof	530-531, 542, 550-551
"57.27"	HNM	594 - 595
	C-TYPE IP65/IP66, single lever	393 - 401
	V-TYPE IP65/IP66, single lever	448 - 453
	E-Xtreme® corrosion proof	532-533, 543, 552-553
"77.27"	HNM	596 - 597
	C-TYPE IP65/IP66, single lever	402 - 411
	V-TYPE IP65/IP66, single lever	454 - 458
	E-Xtreme® corrosion proof	534-535, 544, 554-555
"104.27"	HNM	598 - 599
	C-TYPE IP65/IP66, single lever	412 - 423
	V-TYPE IP65/IP66, single lever	459 - 463
	E-Xtreme® corrosion proof	536-537, 545, 556-557
"77.62"	C-TYPE IP65/IP66, single lever	424 - 429
	E-Xtreme® corrosion proof	546
"104.62"	C-TYPE IP65/IP66, single lever	430
	E-Xtreme® corrosion proof	547

refer to CN.19 pages

frames for modular units with lock-in tab (included)

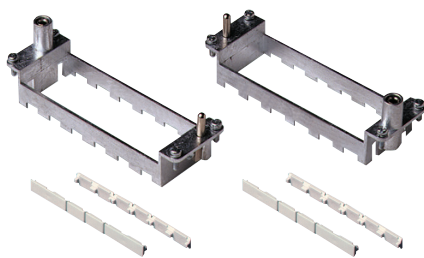

- Q 10.000 MATINGS WITH HNM FRAMES AND HNM ENCLOSURES
- Q 5.000 MATINGS WITH HNM FRAMES AND STANDARD ENCLOSURES, SINGLE LEVER

description	part No.	part No.
frames for modular units, with lock-in tab included	type for hoods*	type for housings*
for 2 modular units - for housing size 44.27	<b>RX 02 TM</b>	<b>RX 02 TF</b>
for 3 modular units - for housing size 57.27	<b>RX 03 TM</b>	<b>RX 03 TF</b>
for 4 modular units - for housing size 77.27 and 77.62	<b>RX 04 TM</b>	<b>RX 04 TF</b>
for 6 modular units - for housing size 104.27 and 104.62	<b>RX 06 TM</b>	<b>RX 06 TF</b>

C-TYPE and V-TYPE 2-lever versions cannot be used to reach 5.000 matings.

- die-cast zinc alloy frames
- protective earth (PE)
- possibility of mounting female and male modular units on the same frame
- frames supplied with lock-in tab to attach units
- polarisation on frames
- coding pins **CR..CX**
- for spare lock-in tab **CX CFM** see SPARE SPARTS catalogue

\* Assignment of attribute "for hoods" or "for housings" is merely conventional: both types can be mounted either in a hood or in a housing. In a modular connector coupling there shall be always a frame type "M" and a frame type "F".

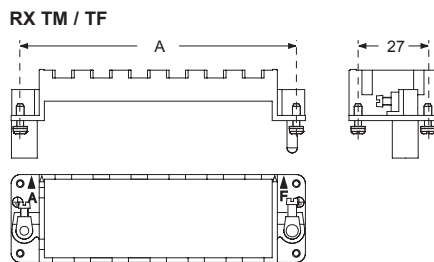

part No.	A (mm)	for housings size
<b>RX 02 TM / TF</b>	44	44.27
<b>RX 03 TM / TF</b>	57	57.27
<b>RX 04 TM / TF</b>	77,5	77.27 and 77.62
<b>RX 06 TM / TF</b>	104	104.27 and 104.62

Earth terminal

- large: for cables from 4-6 mm<sup>2</sup>, AWG 12-10
- small: for cables from 1-2,5 mm<sup>2</sup>, AWG 18-14

In order to accommodate larger PE conductor cross-sectional area, use CGT PE adapters, see page 319 CN.19 catalogue.

position of modules (contact side view)

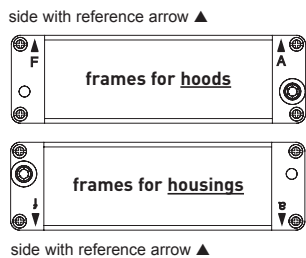

CX CFM (lock-in tab)

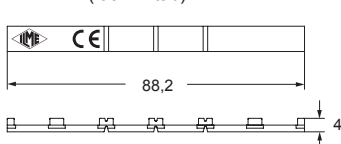

Polarisation of frames with relative identification letters and couplings

frame for hoods <sup>1)</sup> frames for housings <sup>1)</sup>

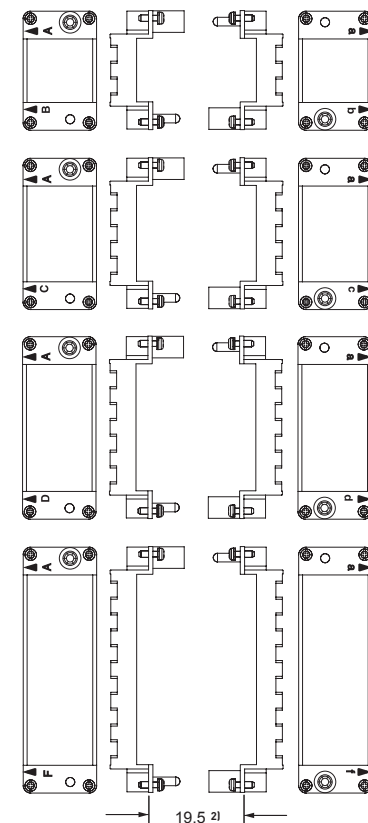

1) Warning:

- The module support frames are marked:
- FOR HOODS: **upper-case** A-B, A-C, A-D and A-F
- FOR HOUSINGS: **lower-case** a-b, a-c, a-d and a-f

Positioning the modules in the frames according to the respective letters is ensuring the specular assembly of modules, for which the hood will be coupled correctly to the housing.

2) Distance for:

- electric and fibre optic contacts: max 21 mm
- pneumatic contacts: max 20,5 mm

# CX 20S IF/IM 20 poles + shield 4 A module - 32 V

## ASSEMBLY INSTRUCTIONS

### MIXO SHIELDED CX 20S IF



Watch our online tutorial

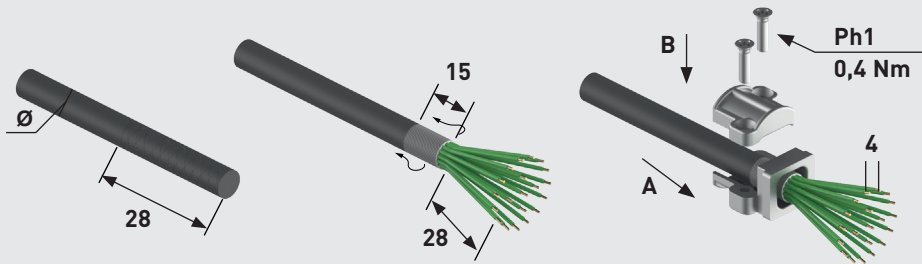

Cable clamp part No.	mm	Screw size	Tightening torque (Nm)	Recommended size of screwdriver
CX 5/7 CA	5-7	M 2,5	0,4	Ph1
CX 7/10 CA	7-10	M 2,5	0,4	Ph1
CX 10/12 CA	10-12	M 2,5	0,4	Ph1
CX 11/14 CA	11-14	M 2,5	0,4	Ph1

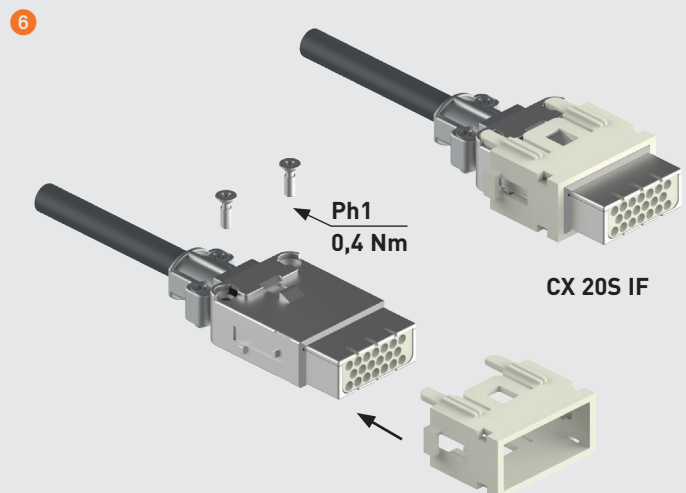
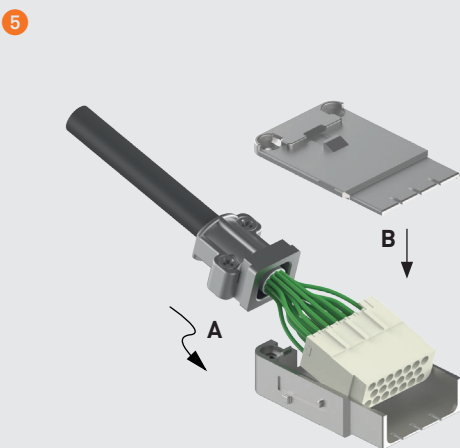
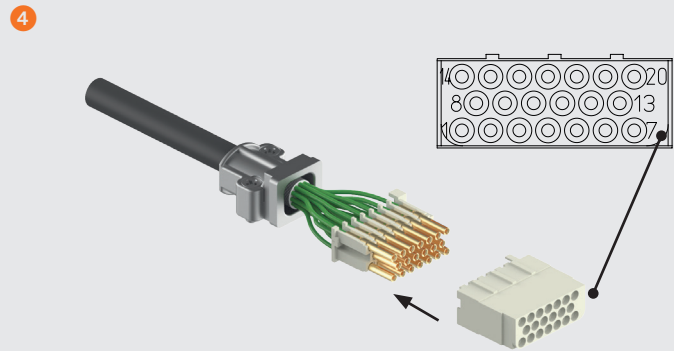
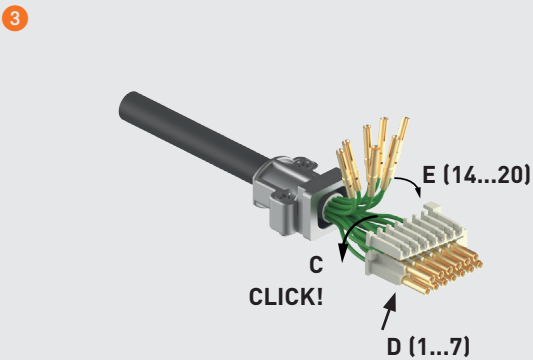
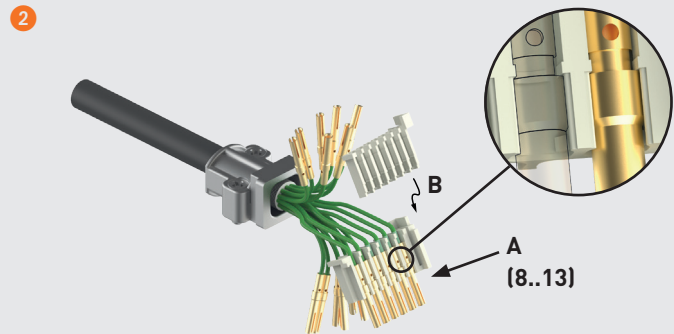
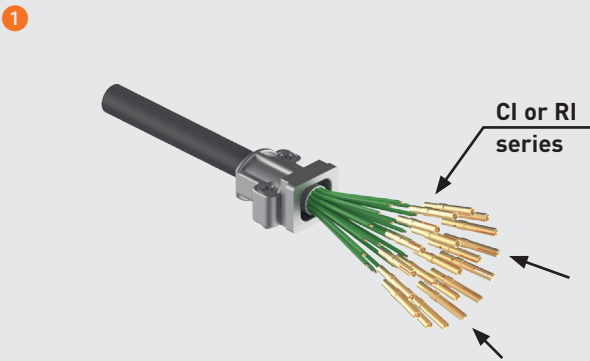



# ASSEMBLY INSTRUCTIONS

## MIXO SHIELDED CX 20S IM



Watch our online tutorial

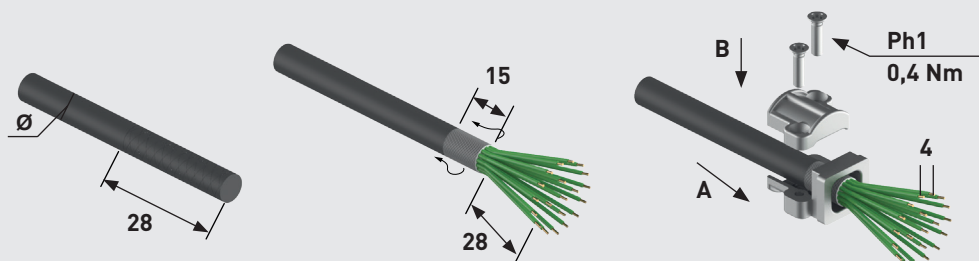

Cable clamp part No.	Ø mm	Screw size	Tightening torque (Nm)	Recommended size of screwdriver
CX 5/7 CA	5-7	M 2,5	0,4	Ph1
CX 7/10 CA	7-10	M 2,5	0,4	Ph1
CX 10/12 CA	10-12	M 2,5	0,4	Ph1
CX 11/14 CA	11-14	M 2,5	0,4	Ph1

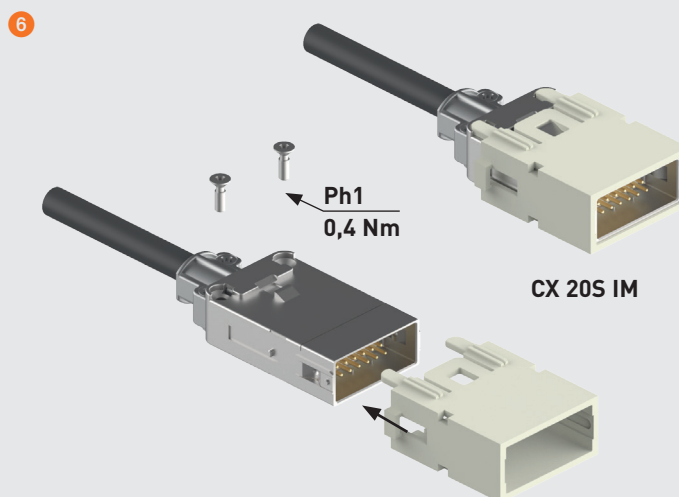
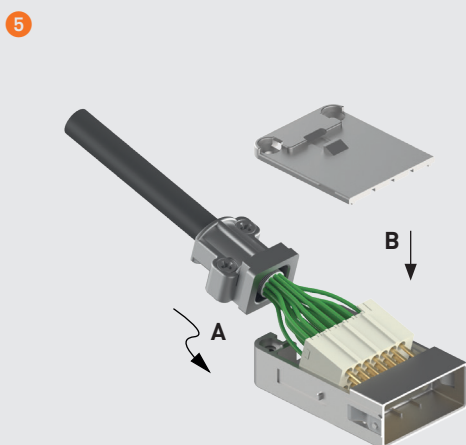
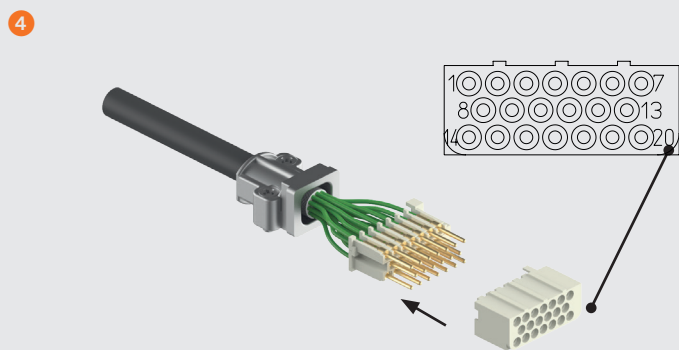
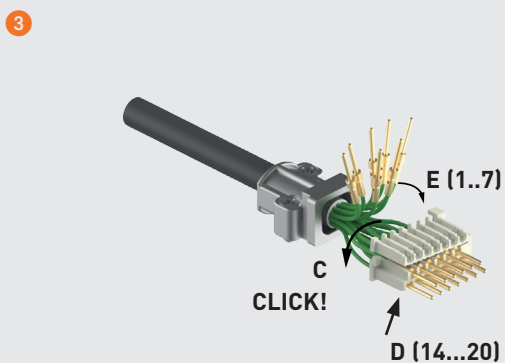
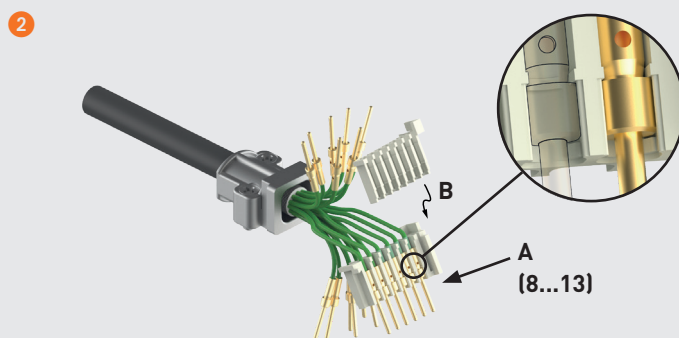
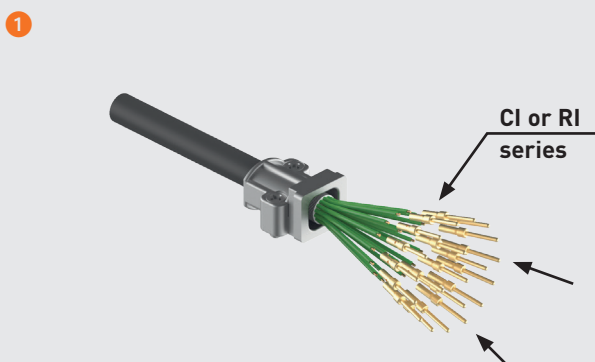



---

## MIXO MEGABIT

CX 08 D5F /M - CX 08 D5F2 /M2

---



### MIXO Megabit module

10 A 8 poles + shield,

CX 08 D5F /M (one cable)

CX 08 D5F2 /M2 (two cables),

EN/IEC 61984 ratings: 10 A 50 V 0,8 kV 3



Find more  
information on  
our products at  
[www.ilme.com](http://www.ilme.com)

## TECHNICAL FEATURES

### CX 08 D5F /M - CX 08 D5F2 /M2

- **8P+shield**, for series **CD** 10 A crimp contacts (**D** in the code) 0,14 mm<sup>2</sup> / 26 AWG ... 2,5 mm<sup>2</sup> /14 AWG (sizes 0.3 through 2.5).
- **Fully shielded** connector module for data transmission, **Megabit Ethernet** Category 5e (**5** in the code), Class D, frequencies up to 100 MHz, data rate up to 100 Mbit/s.
- Available with single cable entry (CX 08 D5F /D5M) or double cable entry (CX 08 D5F2 /D5M2, additional suffix "**2**" in the code):
  - **CX 08 D5F /M** for 1x4-pair + shield data cable (2 x 4 conductors + shield);
  - **CX 08 D5F2 /M2** for or 2x2-pair shield data cable (2 x 2 x 2 conductors + shield).
- Suitable for one or two cables, Ø from 5 mm to 14 mm.
- Screw fixing **cable clamp(s)**, required for cable screen connection to the module shield, is/are separately available in 4 different sizes according to the range of cable Ø in mm: 5/7 – 7/10 – 10/12 and 11/14 (new).  
NOTE – CX 11/14 CA new cable clamp suitable only for single cable entry modules.
- Optionally available, as alternative to the cable clamp, crimp flange and ferrules versions (same as offered for MIXO Gigabit module) to be optimized on the specific dimension of the customer cable.
- **EN/IEC 61984 ratings: 10 A 50 V 0,8 kV 3**  
NOTE – As a connector with extra-low voltage rating, it is out of the scope of the EU Low Voltage Directive 2014/35/EU and of the Russian equivalent Technical Regulation TR CU 004/2011, hence neither the **CE** marking nor the EAC mark are applicable.
- **Lower and Upper Limiting Temperatures** (LLT ... ULT): -40 °C ... +85 °C.  
NOTE – The limitation to the ULT is set upon the usual temperature rating of the telecommunication cables (2x2-pair or 1x4-pair), the insulating materials of the inserts and the metal shield might withstand up to 125 °C.
- Two separate contact holders provide two independently shielded 4-pole connectors in the same body.
- May replace in half space the previously available MIXO BUS 2x multi-axial solution (CX 02 BF /BM plus 2x multi-axial shielded circular insert CX 04 BF /BM).
- Shield separated from the PE circuit (MIXO frame);  
NOTE: For versions with additional shield connection to the MIXO frame (single earth/ground reference, preferred in railway rolling stock applications), part nos. **CX 08 D5GF /GM** (single cable entry) or **CX 08 D5GF2 /GM2** (double cable entry) contact ILME Commercial Offices.
- **Max individual wire sheathing diameter: 3,6 mm**
- Suitable also for MIXO ONE enclosures.

single cable entry  
(CX 08 D5F /M) or  
double cable entry  
(CX 08 D5F2 /M2)

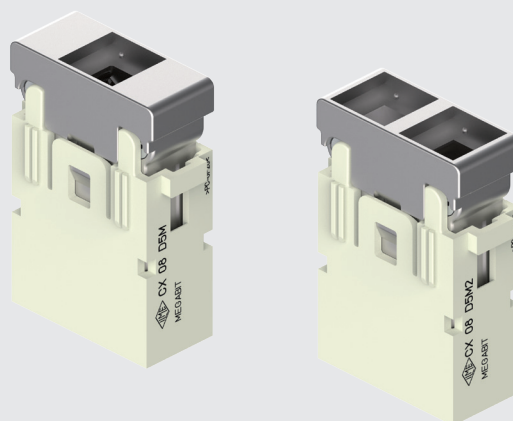

# Megabit 8 poles + shield 10 A - 50 V

The modular inserts must be installed in suitable frames which are then mounted in traditional housings or in COB panel support. Single-sized modular units may be directly mounted inside MIXO ONE enclosures.

pages:

frames for modular units 317

MIXO ONE enclosures 369

- we recommend the use of CRF / CRM code pins together with relevant MIXO frame

refer to CN.19 pages

modular units,  
crimp connection  
single cable entry

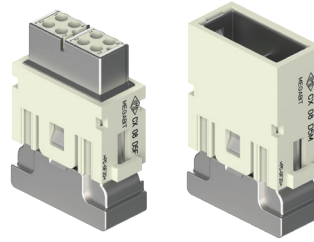

modular units,  
crimp connection  
double cable entry

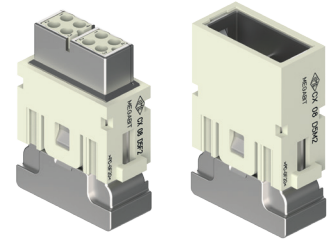

description

part No.

part No.

without contacts (to be ordered separately)  
female inserts for female contacts  
male inserts for male contacts

**CX 08 D5F**  
**CX 08 D5M**

without contacts (to be ordered separately)  
female inserts for female contacts  
male inserts for male contacts

**CX 08 D5F2**  
**CX 08 D5M2**

- characteristics according to EN/IEC 61984 ratings:  
**10 A 50 V 0,8 kV 3**

- (ECBT2.E115072, ECBT8.E115072),

- certified  
- BV pending

- rated voltage according to UL/CSA: 50 V

- insulation resistance:  $\geq 10 \text{ G}\Omega$

- ambient temperature limit:  $-40 \text{ }^\circ\text{C} \dots +85 \text{ }^\circ\text{C}$

- fully shielded connector module for data transmission, Megabit Ethernet Category 5e (5 in the code), Class D,

frequencies up to 100 MHz, data rate up to 100 Mbit/s

- shield electrically separated from the PE of the frame

- made of self-extinguishing thermoplastic resin

UL 94V-0

- shield made by zinc-alloy

- mechanical life:  $\geq 500$  cycles

- contact resistance:  $\leq 3 \text{ m}\Omega$

- it is recommended to crimp the contacts with crimping tools homologated by ILME (please see the crimping tool section 10A contacts CDF, CDM series pages 708 - 741 of CN.19 catalogue).

For 10A contacts CDF, CDM series, see also the new pneumatic crimping tool CCPZP RN (see page 145).

**CX 08 D5F, CX 08 D5M**

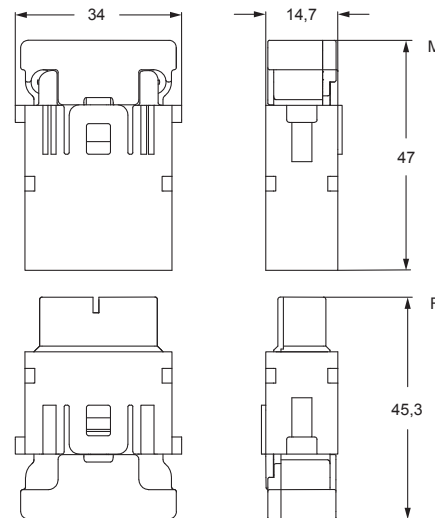

contacts side (front view)

side with reference arrow ▲

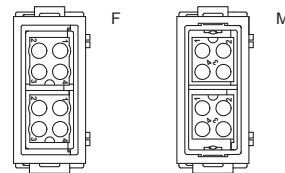

- 1 frame slot

**CX 08 D5F2, CX 08 D5M2**

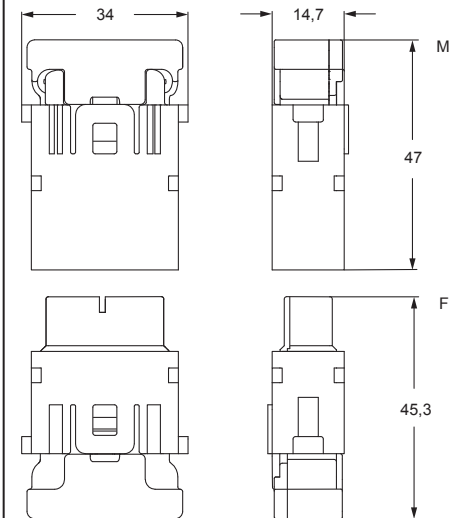

contacts side (front view)

side with reference arrow ▲

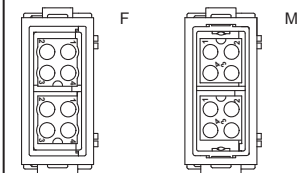

- 1 frame slot

# CX...CA Cable clamp - CD 10 A Crimp contacts

## cable clamp



## CD (10 A) crimp contacts gold plated



description

part No.

part No.

cable clamp for 5-7 mm cable diameter  
 cable clamp for 7-10 mm cable diameter  
 cable clamp for 10-12 mm cable diameter \*

**CX 5/7 CA**  
**CX 7/10 CA**  
**CX 10/12 CA**

### 10 A female contacts

0,14-0,37 mm <sup>2</sup>	AWG 26-22	identification No. 1
0,5 mm <sup>2</sup>	AWG 20	identification No. 2
0,75 mm <sup>2</sup>	AWG 18	identification No. ②
1 mm <sup>2</sup>	AWG 18	identification No. 3
1,5 mm <sup>2</sup>	AWG 16	identification No. 4
2,5 mm <sup>2</sup>	AWG 14	identification No. 5

**CDFD 0.3**  
**CDFD 0.5**  
**CDFD 0.7**  
**CDFD 1.0**  
**CDFD 1.5**  
**CDFD 2.5**

gold plated+

### 10 A male contacts

0,14-0,37 mm <sup>2</sup>	AWG 26-22	identification No. 1
0,5 mm <sup>2</sup>	AWG 20	identification No. 2
0,75 mm <sup>2</sup>	AWG 18	identification No. ②
1 mm <sup>2</sup>	AWG 18	identification No. 3
1,5 mm <sup>2</sup>	AWG 16	identification No. 4
2,5 mm <sup>2</sup>	AWG 14	identification No. 5

**CDMD 0.3**  
**CDMD 0.5**  
**CDMD 0.7**  
**CDMD 1.0**  
**CDMD 1.5**  
**CDMD 2.5**

\* only for single cable entry modules

☑ Upon request we can supply crimp flange and crimp sleeves of different diameters that must be chosen according to the specific cable shield and insulation diameter, please contact ILME Commercial Offices.

crimp flange

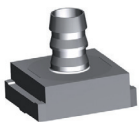

crimp sleeves



### CX 5/7 CA, CX 7/10 CA, CX 10/12 CA

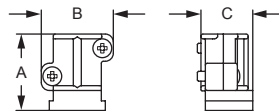

part No.	A	B	C
<b>CX 5/7 CA</b>	19,1	18	12,95
<b>CX 7/10 CA</b>	19,1	18	12,95
<b>CX 10/12 CA</b>	19,1	20,8	12,95

### CDF and CDM

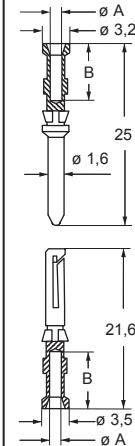

### CDF and CDM contacts

conductor section mm <sup>2</sup>	conductor slot ø A (mm)	conductors stripping length B (mm)
0,14-0,37	0,9	8
0,5	1,1	8
0,75	1,3	8
1,0	1,45	8
1,5	1,8	8
2,5	2,2	6

+ for basic or high thickness gold plating, please refer to page 674 of CN.19 catalogue

The modular inserts must be installed in suitable frames which are then mounted in HNM enclosures.

frames for modular units

page:

48

- we recommend the use of CRF / CRM code pins together with relevant MIXO frame

modular units, crimp connection  
single cable entry

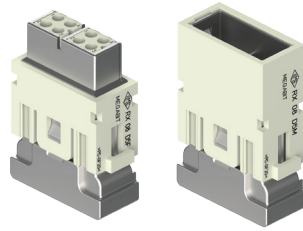

**Q 10.000 MATINGS WITH HNM FRAMES AND HNM ENCLOSURES**  
**Q 5.000 MATINGS WITH HNM FRAMES AND STANDARD ENCLOSURES, SINGLE LEVER**

**FROM NOVEMBER 2020**

modular units, crimp connection  
double cable entry

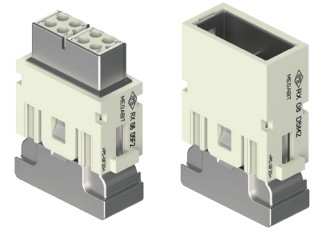

**Q 10.000 MATINGS WITH HNM FRAMES AND HNM ENCLOSURES**  
**Q 5.000 MATINGS WITH HNM FRAMES AND STANDARD ENCLOSURES, SINGLE LEVER**

**FROM NOVEMBER 2020**

description

part No.

part No.

without contacts (to be ordered separately)  
female inserts for female contacts  
male inserts for male contacts

**RX 08 D5F**  
**RX 08 D5M**

without contacts (to be ordered separately)  
female inserts for female contacts  
male inserts for male contacts

**RX 08 D5F2**  
**RX 08 D5M2**

- characteristics according to EN/IEC 61984 ratings: **10 A 50 V 0,8 kV 3**
- **UL**us (ECBT2.E115072, ECBT8.E115072), **CQC**
- **DNV** certified
- BV pending
- rated voltage according to UL/CSA: 50 V
- insulation resistance:  $\geq 10 \text{ G}\Omega$
- ambient temperature limit:  $-40 \text{ }^\circ\text{C} \dots +85 \text{ }^\circ\text{C}$
- fully shielded connector module for data transmission, Megabit Ethernet Category 5e (5 in the code), Class D, frequencies up to 100 MHz, data rate up to 100 Mbit/s
- shield electrically separated from the PE of the frame
- made of self-extinguishing thermoplastic resin UL 94V-0
- shield made by zinc-alloy
- mechanical life:  $\geq 10.000$  cycles
- contact resistance:  $\leq 3 \text{ m}\Omega$
- **it is recommended to crimp the contacts with crimping tools homologated by ILME** (please see the crimping tool section 10A contacts RDF2D, RDM2D series, pages 708 - 741 of CN.19 catalogue). For 10A contacts RDF2D, RDM2D series, see also the new pneumatic crimping tool CCPZP RN (see page 145).

**RX 08 D5F, RX 08 D5M**

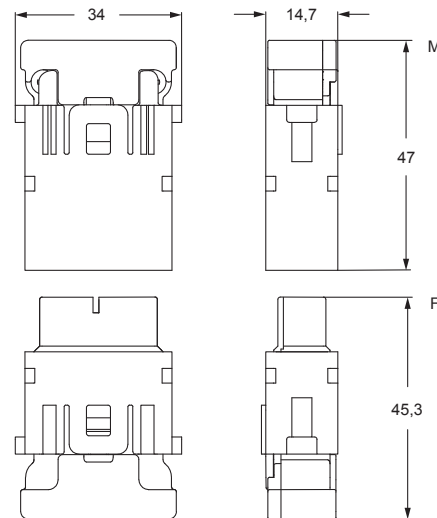

contacts side (front view)

side with reference arrow ▲

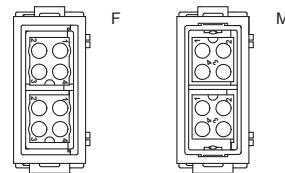

- 1 frame slot

**RX 08 D5F2, RX 08 D5M2**

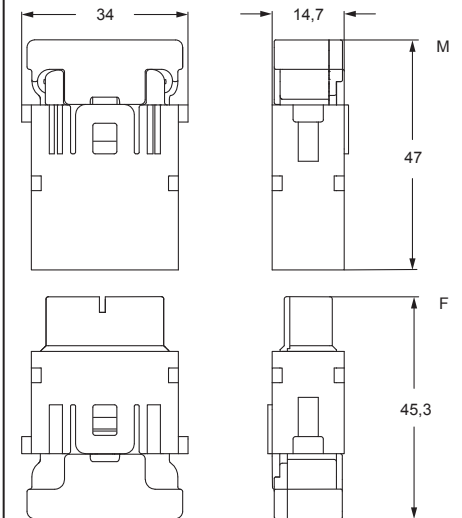

contacts side (front view)

side with reference arrow ▲

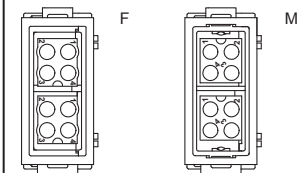

- 1 frame slot

# CX...CA Cable clamp - HNM RD 2D 10 A Crimp contacts

## cable clamp



## RD 2D (10 A) crimp contacts gold plated



description

part No.

part No.

cable clamp for 5-7 mm cable diameter  
cable clamp for 7-10 mm cable diameter  
cable clamp for 10-12 mm cable diameter \*

**CX 5/7 CA**  
**CX 7/10 CA**  
**CX 10/12 CA**

### 10 A female contacts

0,14-0,37 mm <sup>2</sup>	AWG 26-22	identification No. 1
0,5 mm <sup>2</sup>	AWG 20	identification No. 2
0,75 mm <sup>2</sup>	AWG 18	identification No. ②
1 mm <sup>2</sup>	AWG 18	identification No. 3
1,5 mm <sup>2</sup>	AWG 16	identification No. 4
2,5 mm <sup>2</sup>	AWG 14	identification No. 5

**RDF2D 0.3**  
**RDF2D 0.5**  
**RDF2D 0.7**  
**RDF2D 1.0**  
**RDF2D 1.5**  
**RDF2D 2.5**

gold plated

### 10 A male contacts

0,14-0,37 mm <sup>2</sup>	AWG 26-22	identification No. 1
0,5 mm <sup>2</sup>	AWG 20	identification No. 2
0,75 mm <sup>2</sup>	AWG 18	identification No. ②
1 mm <sup>2</sup>	AWG 18	identification No. 3
1,5 mm <sup>2</sup>	AWG 16	identification No. 4
2,5 mm <sup>2</sup>	AWG 14	identification No. 5

**RDM2D 0.3**  
**RDM2D 0.5**  
**RDM2D 0.7**  
**RDM2D 1.0**  
**RDM2D 1.5**  
**RDM2D 2.5**

\* only for single cable entry modules

☑ Upon request we can supply crimp flange and crimp sleeves of different diameters that must be chosen according to the specific cable shield and insulation diameter, please contact ILME Commercial Offices.

crimp  
flange

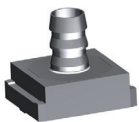

crimp  
sleeves



### CX 5/7 CA, CX 7/10 CA, CX 10/12 CA

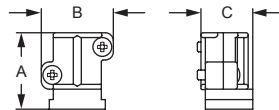

part No.	A	B	C
<b>CX 5/7 CA</b>	19,1	18	12,95
<b>CX 7/10 CA</b>	19,1	18	12,95
<b>CX 10/12 CA</b>	19,1	20,8	12,95

### RDF2D and RDM2D

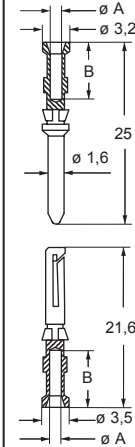

### RDF2D and RDM2D contacts

conductor section mm <sup>2</sup>	conductor slot $\varnothing$ A (mm)	conductors stripping length B (mm)
0,14-0,37	0,9	8
0,5	1,1	8
0,75	1,3	8
1,0	1,45	8
1,5	1,8	8
2,5	2,2	6

enclosures size:		pages:
"44.27"	HNM	592 - 593
	C-TYPE IP65/IP66, single lever	387 - 392
	V-TYPE IP65/IP66, single lever	444 - 447
	E-Xtreme® corrosion proof	530-531, 542, 550-551
"57.27"	HNM	594 - 595
	C-TYPE IP65/IP66, single lever	393 - 401
	V-TYPE IP65/IP66, single lever	448 - 453
	E-Xtreme® corrosion proof	532-533, 543, 552-553
"77.27"	HNM	596 - 597
	C-TYPE IP65/IP66, single lever	402 - 411
	V-TYPE IP65/IP66, single lever	454 - 458
	E-Xtreme® corrosion proof	534-535, 544, 554-555
"104.27"	HNM	598 - 599
	C-TYPE IP65/IP66, single lever	412 - 423
	V-TYPE IP65/IP66, single lever	459 - 463
	E-Xtreme® corrosion proof	536-537, 545, 556-557
"77.62"	C-TYPE IP65/IP66, single lever	424 - 429
	E-Xtreme® corrosion proof	546
"104.62"	C-TYPE IP65/IP66, single lever	430
	E-Xtreme® corrosion proof	547

refer to CN.19 pages

frames for modular units with lock-in tab (included)

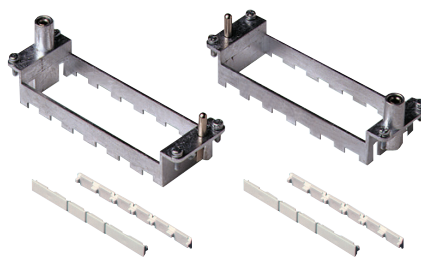

Q 10.000 MATINGS WITH HNM FRAMES AND HNM ENCLOSURES

Q 5.000 MATINGS WITH HNM FRAMES AND STANDARD ENCLOSURES, SINGLE LEVER

description	part No.	part No.
frames for modular units, with lock-in tab included	type for hoods*	type for housings*
for 2 modular units - for housing size 44.27	<b>RX 02 TM</b>	<b>RX 02 TF</b>
for 3 modular units - for housing size 57.27	<b>RX 03 TM</b>	<b>RX 03 TF</b>
for 4 modular units - for housing size 77.27 and 77.62	<b>RX 04 TM</b>	<b>RX 04 TF</b>
for 6 modular units - for housing size 104.27 and 104.62	<b>RX 06 TM</b>	<b>RX 06 TF</b>

C-TYPE and V-TYPE 2-lever versions cannot be used to reach 5.000 matings.

- die-cast zinc alloy frames
- protective earth (PE)
- possibility of mounting female and male modular units on the same frame
- frames supplied with lock-in tab to attach units
- polarisation on frames
- coding pins **CR..CX**
- for spare lock-in tab **CX CFM** see SPARE SPARTS catalogue

\* Assignment of attribute "for hoods" or "for housings" is merely conventional: both types can be mounted either in a hood or in a housing. In a modular connector coupling there shall be always a frame type "M" and a frame type "F".

RX TM / TF

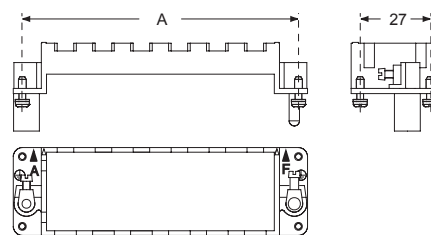

part No.	A (mm)	for housings size
<b>RX 02 TM / TF</b>	44	44.27
<b>RX 03 TM / TF</b>	57	57.27
<b>RX 04 TM / TF</b>	77,5	77.27 and 77.62
<b>RX 06 TM / TF</b>	104	104.27 and 104.62

Earth terminal

- large: for cables from 4-6 mm<sup>2</sup>, AWG 12-10
- small: for cables from 1-2,5 mm<sup>2</sup>, AWG 18-14

In order to accommodate larger PE conductor cross-sectional area, use CGT PE adapters, see page 319 CN.19 catalogue.

position of modules (contact side view)

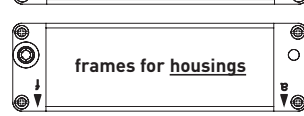
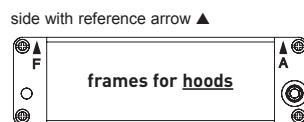

CX CFM (lock-in tab)

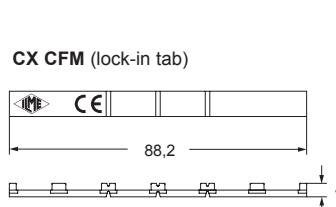

Polarisation of frames with relative identification letters and couplings

frame for hoods 1) frames for housings 1)

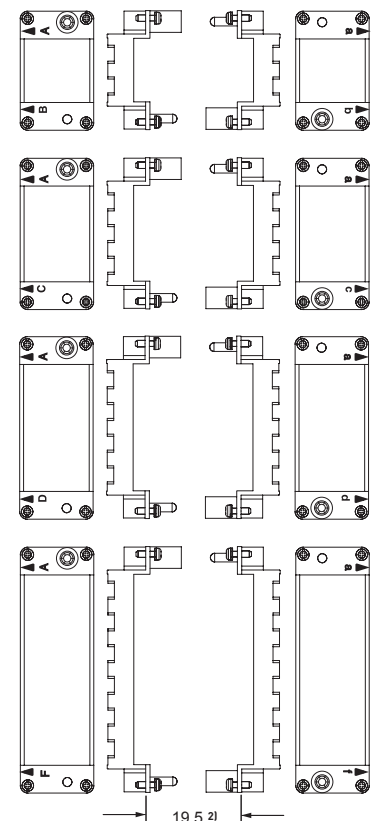

1) Warning:

- The module support frames are marked:
- FOR HOODS: **upper-case A-B, A-C, A-D and A-F**
- FOR HOUSINGS: **lower-case a-b, a-c, a-d and a-f**

Positioning the modules in the frames according to the respective letters is ensuring the specular assembly of modules, for which the hood will be coupled correctly to the housing.

2) Distance for:

- electric and fibre optic contacts: max 21 mm
- pneumatic contacts: max 20,5 mm

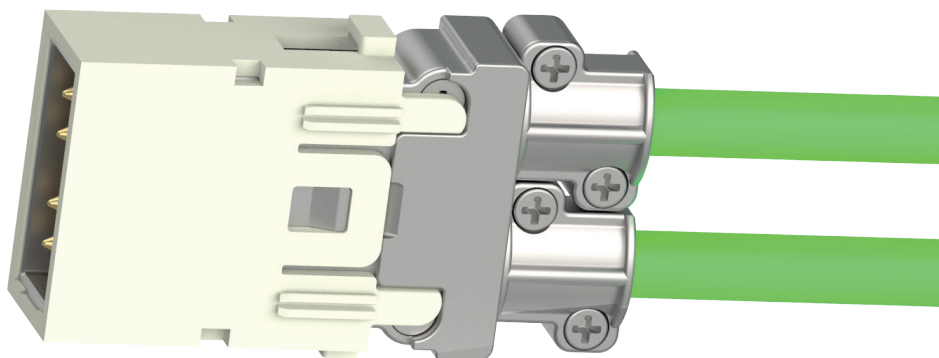

**MIXO MEGABIT - CX 08 D5F2 /M2**

# Megabit 8 poles + shield 10 A - 50 V

## ASSEMBLY INSTRUCTIONS

### MIXO MEGABIT CX 08 D5F



Watch our online tutorial

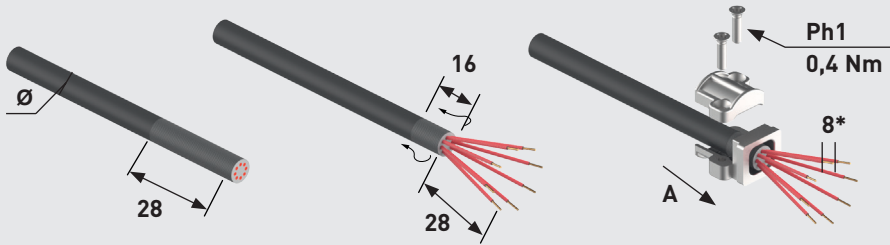

Cable clamp part No.	∅ mm	Screw size	Tightening torque (Nm)	Recommended size of screwdriver
CX 5/7 CA	5-7	M 2,5	0,4	Ph1
CX 7/10 CA	7-10	M 2,5	0,4	Ph1
CX 10/12 CA	10-12	M 2,5	0,4	Ph1

\* 6 mm for CD and RD...2.5

1

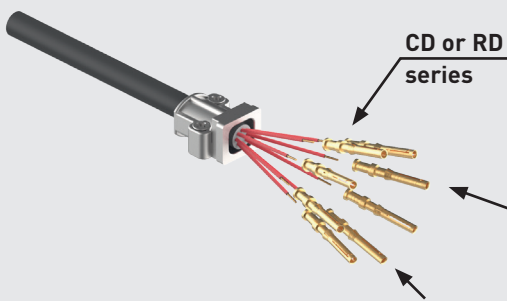

2

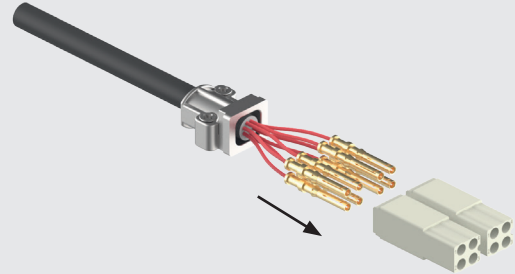

3

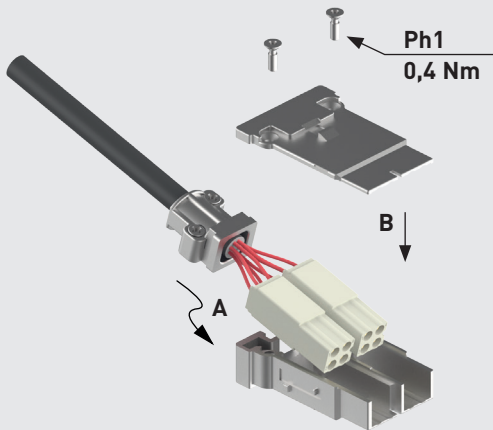

4

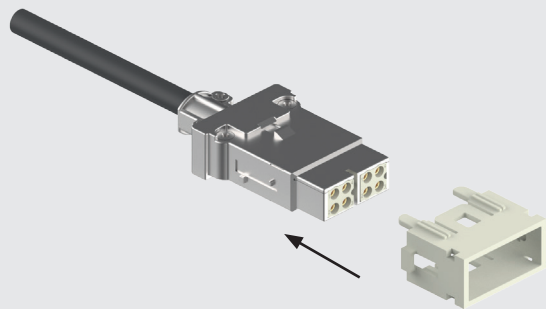

5

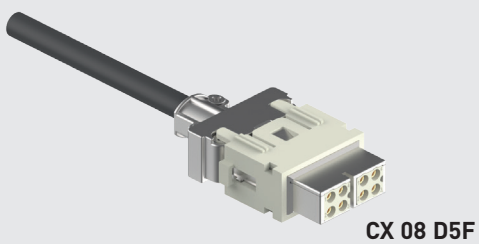

# ASSEMBLY INSTRUCTIONS

## MIXO MEGABIT CX 08 D5M



Watch our online tutorial

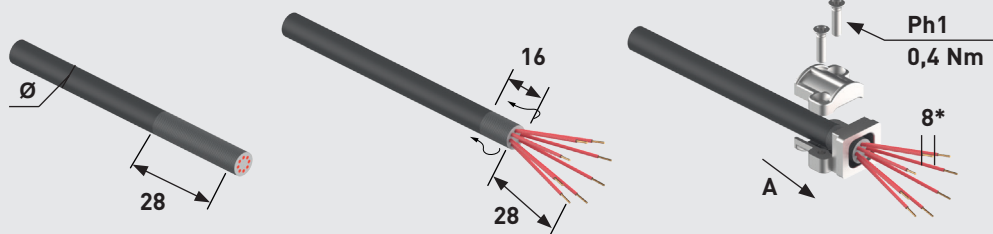

Cable clamp part No.	mm	Screw size	Tightening torque (Nm)	Recommended size of screwdriver
CX 5/7 CA	5-7	M 2,5	0,4	Ph1
CX 7/10 CA	7-10	M 2,5	0,4	Ph1
CX 10/12 CA	10-12	M 2,5	0,4	Ph1

\* 6 mm for CD and RD...2.5

1

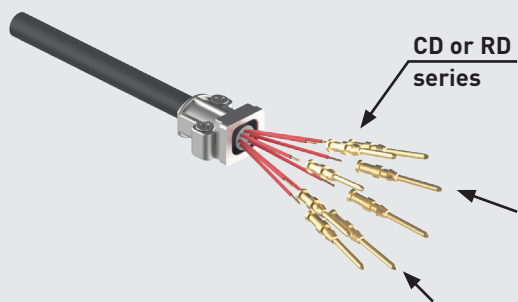

2

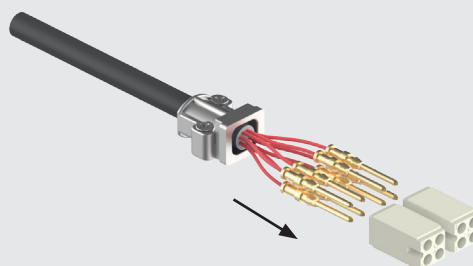

3

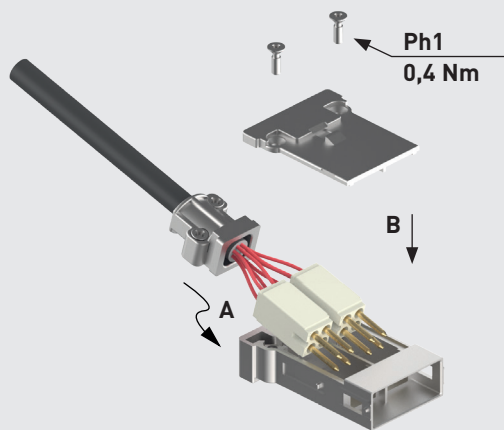

4

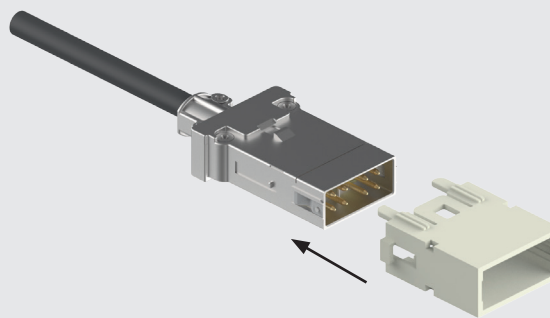

5

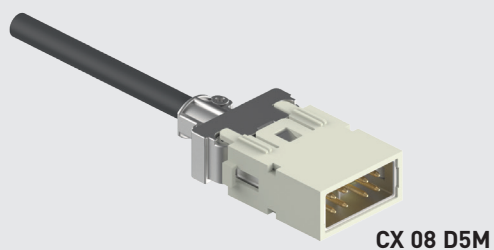

# Megabit 8 poles + shield 10 A - 50 V

## ASSEMBLY INSTRUCTIONS

### MIXO MEGABIT CX 08 D5F2



Watch our online tutorial

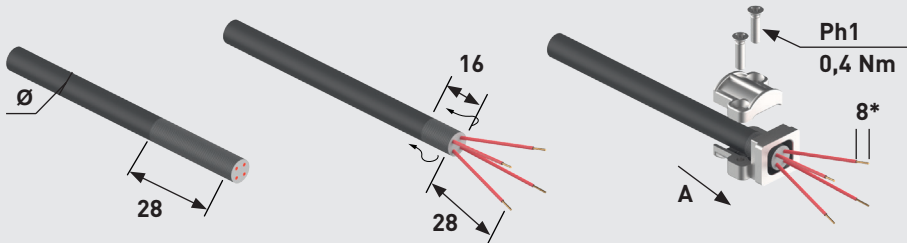

Cable clamp part No.	mm	Screw size	Tightening torque (Nm)	Recommended size of screwdriver
CX 5/7 CA	5-7	M 2,5	0,4	Ph1
CX 7/10 CA	7-10	M 2,5	0,4	Ph1
CX 10/12 CA	10-12	M 2,5	0,4	Ph1

2x

\* 6 mm for CD and RD..2.5

1

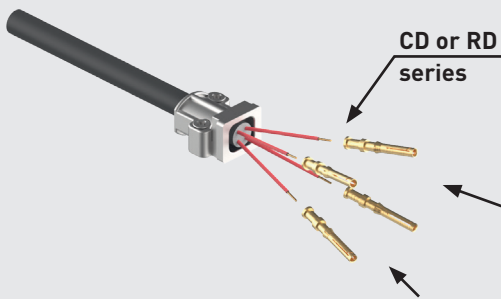

2x

2

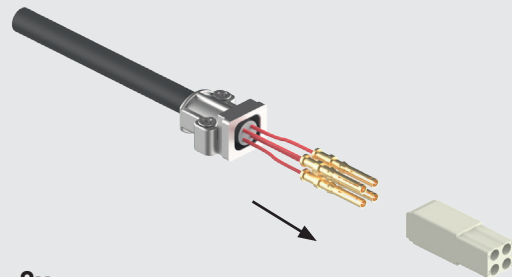

2x

3

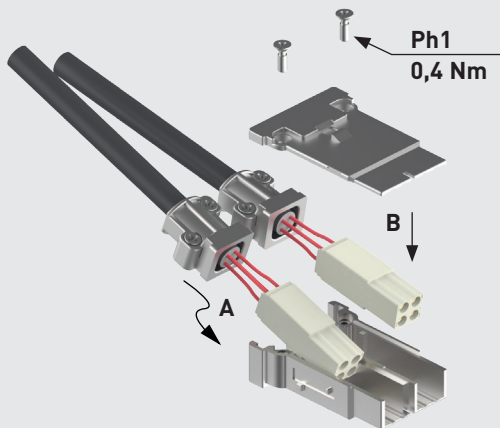

4

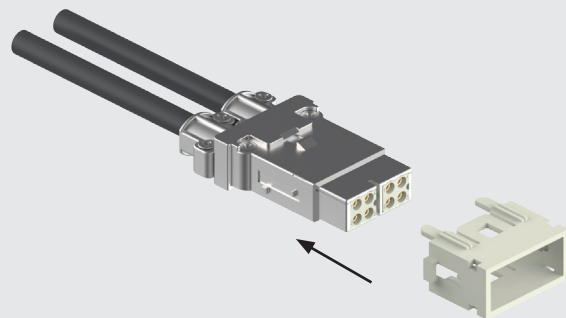

5

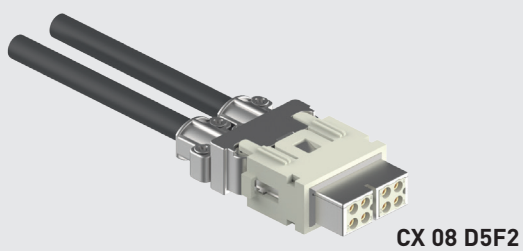

CX 08 D5F2

# ASSEMBLY INSTRUCTIONS

## MIXO MEGABIT CX 08 D5M2



Watch our online tutorial

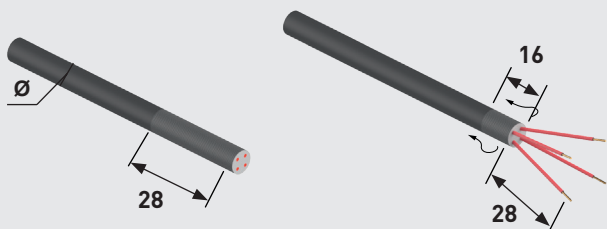

2x

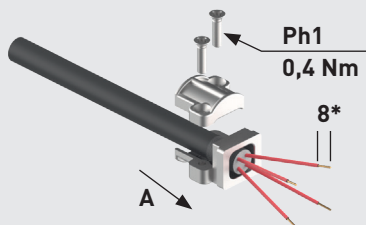

\* 6 mm for CD and RD..2.5

Cable clamp part No.	Ø mm	Screw size	Tightening torque (Nm)	Recommended size of screwdriver
CX 5/7 CA	5-7	M 2,5	0,4	Ph1
CX 7/10 CA	7-10	M 2,5	0,4	Ph1
CX 10/12 CA	10-12	M 2,5	0,4	Ph1

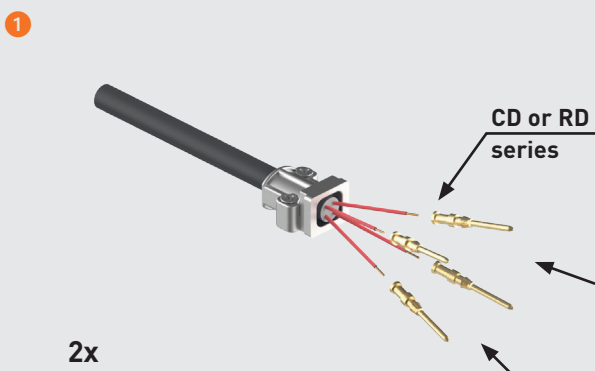

2x

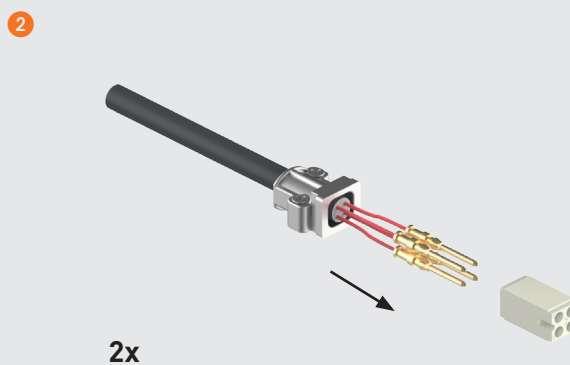

2x

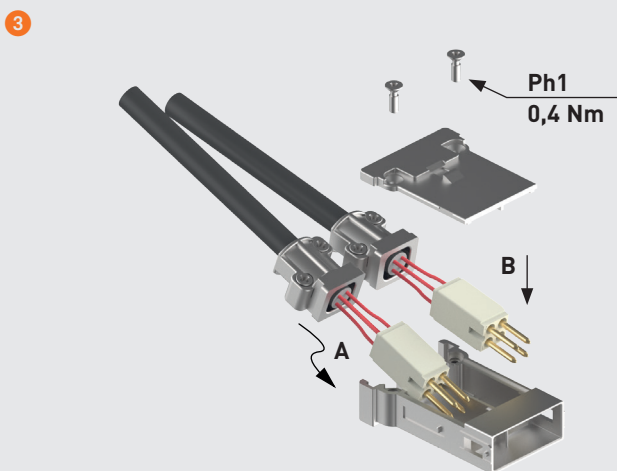

4

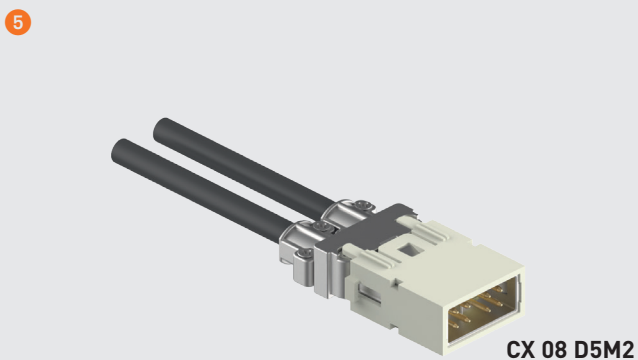
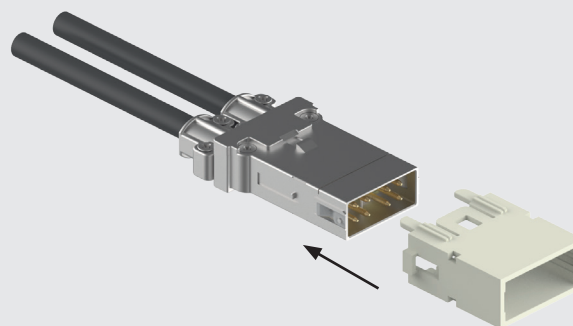

CX 08 D5M2

The modular inserts must be installed in suitable frames which are then mounted in HNM enclosures.

page:

frames for modular units\*

55

\* enclosures: bulkhead mounting housings, high construction housings or high construction hoods

- we recommend the use of CRF / CRM code pins together with relevant MIXO frame

modular units,  
crimp connections

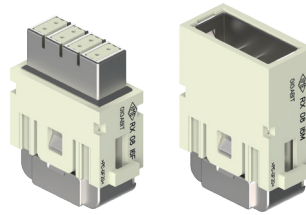

Q 10.000 MATINGS WITH HNM FRAMES AND HNM ENCLOSURES  
Q 5.000 MATINGS WITH HNM FRAMES AND STANDARD ENCLOSURES, SINGLE LEVER

FROM NOVEMBER 2020

cable clamp

RI (5 A) crimp contacts, gold plated

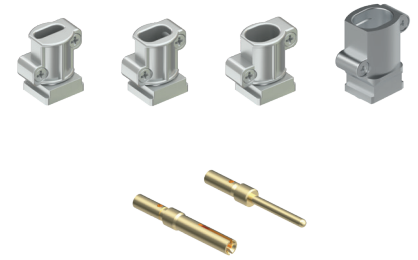

description

part No.

part No.

without contacts (to be ordered separately)

female insert for female contacts

RX 08 I6F

male insert for male contacts

RX 08 I6M

cable clamp for 5-7 mm cable diameter

CX 5/7 CA

cable clamp for 7-10 mm cable diameter

CX 7/10 CA

cable clamp for 10-12 mm cable diameter

CX 10/12 CA

cable clamp for 11-14 mm cable diameter

CX 11/14 CA

RI (5 A) female crimp contacts

0,08-0,21 mm<sup>2</sup> AWG 28-24

RIFD 0.2

0,13-0,33 mm<sup>2</sup> AWG 26-22

RIFD 0.3

0,33-0,52 mm<sup>2</sup> AWG 22-20

RIFD 0.5

RI (5 A) male crimp contacts

0,08-0,21 mm<sup>2</sup> AWG 28-24

RIMD 0.2

0,13-0,33 mm<sup>2</sup> AWG 26-22

RIMD 0.3

0,33-0,52 mm<sup>2</sup> AWG 22-20

RIMD 0.5

gold plated

- characteristics according to EN/IEC 61984 ratings:

5 A 50 V 0,8 kV 3

- cULus (ECBT2.E115072, ECBT8.E115072), cUL

- DNV certified

- BV pending

- rated voltage according to UL/CSA: 50 V

- insulation resistance:  $\geq 10$  G $\Omega$

- ambient temperature limit: -40 °C ... +85 °C

- suitable for bus signals, in particular for Ethernet Cat. 6A (Gigabit)

- shield electrically separated from the PE of the frame  
- made of self-extinguishing thermoplastic resin UL 94V-0

- mechanical life:  $\geq 10.000$  cycles

- contact resistance:  $\leq 4$  m $\Omega$

- for crimp contacts RI series use:

CIPZ D crimping tool

CIPZP D pneumatic crimping tool (see page 144)

CITP D turret head

CIES insertion / removal tool for contacts 0,2 - 0,5 mm<sup>2</sup> (see pages 716 - 719 of CN.19 catalogue)

RX 08 I6F, RX 08 I6M

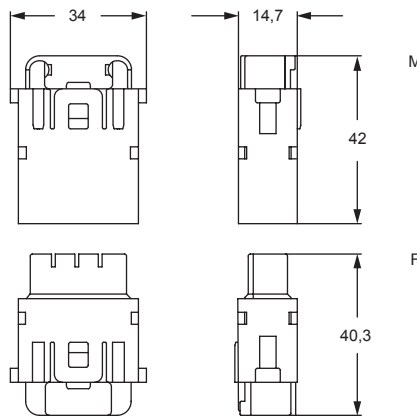

contacts side (front view)

side with reference arrow ▲

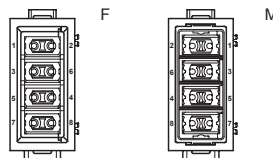

- 1 frame slot

CX 5/7 CA, CX 7/10 CA, CX 10/12 CA

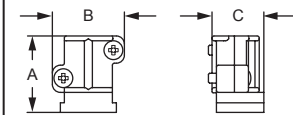

part No.	A	B	C
CX 5/7 CA	19,1	18	12,95
CX 7/10 CA	19,1	18	12,95
CX 10/12 CA	19,1	20,8	12,95

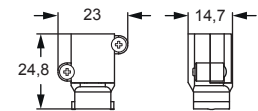

RIF and RIM

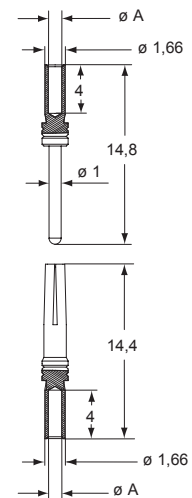

RIF and RIM contacts

conductor section (mm <sup>2</sup> )	conductor slot $\varnothing$ A (mm)	conductors stripping length (mm)
0,08-0,21	0,64	4
0,13-0,33	0,90	4
0,33-0,52	1,12	4



enclosures size:		pages:
"44.27"	HNM	592 - 593
	C-TYPE IP65/IP66, single lever	387 - 392
	V-TYPE IP65/IP66, single lever	444 - 447
	E-Xtreme® corrosion proof	530-531, 542, 550-551
"57.27"	HNM	594 - 595
	C-TYPE IP65/IP66, single lever	393 - 401
	V-TYPE IP65/IP66, single lever	448 - 453
	E-Xtreme® corrosion proof	532-533, 543, 552-553
"77.27"	HNM	596 - 597
	C-TYPE IP65/IP66, single lever	402 - 411
	V-TYPE IP65/IP66, single lever	454 - 458
	E-Xtreme® corrosion proof	534-535, 544, 554-555
"104.27"	HNM	598 - 599
	C-TYPE IP65/IP66, single lever	412 - 423
	V-TYPE IP65/IP66, single lever	459 - 463
	E-Xtreme® corrosion proof	536-537, 545, 556-557
"77.62"	C-TYPE IP65/IP66, single lever	424 - 429
	E-Xtreme® corrosion proof	546
"104.62"	C-TYPE IP65/IP66, single lever	430
	E-Xtreme® corrosion proof	547

refer to CN.19 pages

frames for modular units with lock-in tab (included)

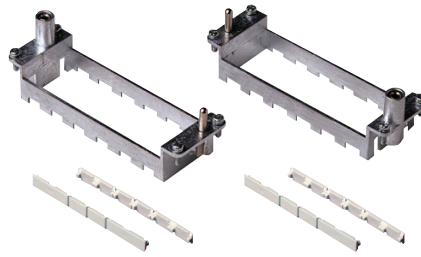

- Q 10.000 MATINGS WITH HNM FRAMES AND HNM ENCLOSURES
- Q 5.000 MATINGS WITH HNM FRAMES AND STANDARD ENCLOSURES, SINGLE LEVER

description	part No.	part No.
frames for modular units, with lock-in tab included	type for hoods*	type for housings*
for 2 modular units - for housing size 44.27	<b>RX 02 TM</b>	<b>RX 02 TF</b>
for 3 modular units - for housing size 57.27	<b>RX 03 TM</b>	<b>RX 03 TF</b>
for 4 modular units - for housing size 77.27 and 77.62	<b>RX 04 TM</b>	<b>RX 04 TF</b>
for 6 modular units - for housing size 104.27 and 104.62	<b>RX 06 TM</b>	<b>RX 06 TF</b>

C-TYPE and V-TYPE 2-lever versions cannot be used to reach 5.000 matings.

- die-cast zinc alloy frames
- protective earth (PE)
- possibility of mounting female and male modular units on the same frame
- frames supplied with lock-in tab to attach units
- polarisation on frames
- coding pins **CR..CX**
- for spare lock-in tab **CX CFM** see SPARE SPARTS catalogue

\* Assignment of attribute "for hoods" or "for housings" is merely conventional: both types can be mounted either in a hood or in a housing. In a modular connector coupling there shall be always a frame type "M" and a frame type "F".

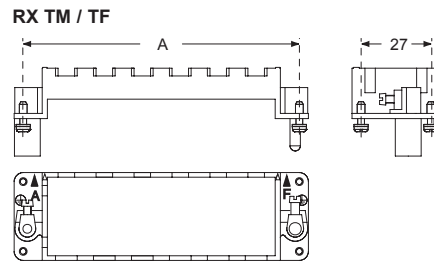

part No.	A (mm)	for housings size
<b>RX 02 TM / TF</b>	44	44.27
<b>RX 03 TM / TF</b>	57	57.27
<b>RX 04 TM / TF</b>	77,5	77.27 and 77.62
<b>RX 06 TM / TF</b>	104	104.27 and 104.62

**Earth terminal**  
 - large: for cables from 4-6 mm<sup>2</sup>, AWG 12-10  
 - small: for cables from 1-2,5 mm<sup>2</sup>, AWG 18-14

In order to accommodate larger PE conductor cross-sectional area, use CGT PE adapters, see page 319 CN.19 catalogue.

position of modules (contact side view)

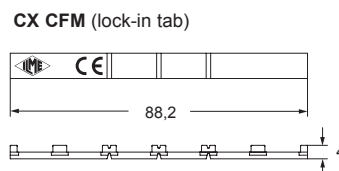
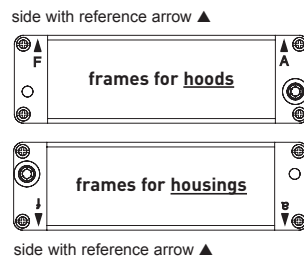

Polarisation of frames with relative identification letters and couplings

frame for hoods <sup>1)</sup> frames for housings <sup>1)</sup>

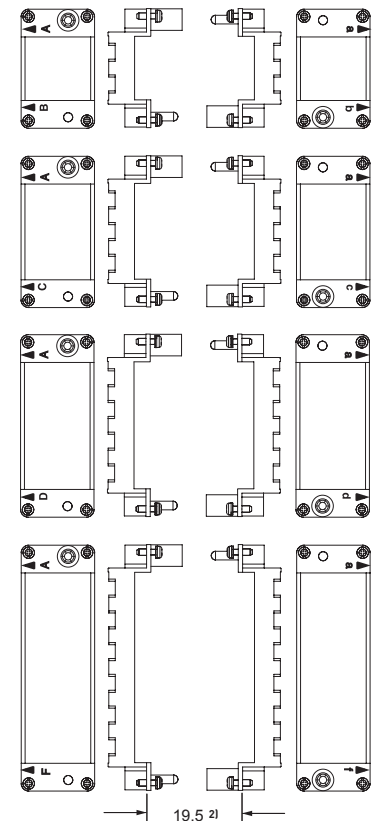

- 1) Warning:**  
 The module support frames are marked:  
 - FOR HOODS: **upper-case** A-B, A-C, A-D and A-F  
 - FOR HOUSINGS: **lower-case** a-b, a-c, a-d and a-f
- Positioning the modules in the frames according to the respective letters is ensuring the specular assembly of modules, for which the hood will be coupled correctly to the housing.
- 2) Distance for:**  
 - electric and fibre optic contacts: max 21 mm  
 - pneumatic contacts: max 20,5 mm



---

## MIXO HDMI MODULE

CX 01 MIF /MIM

CW 2 MIAM /MIAF PATCH CORDS

---

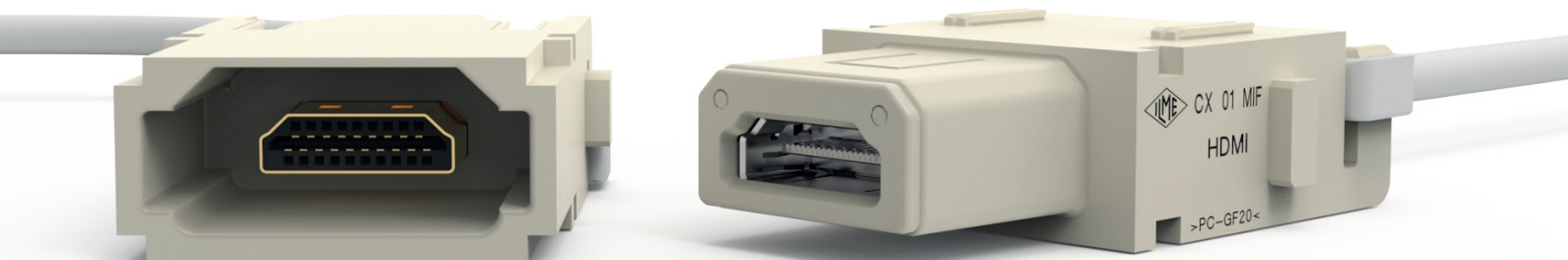

MIXO HDMI module

for high quality video signal transmission

EN/IEC 61984 ratings: 0,5 A 40 V 0,8 kV 3

CW 2 MIAM /MIAF HDMI Type A patch cords (2 m)



Find more  
information on  
our products at  
[www.ilme.com](http://www.ilme.com)

## TECHNICAL FEATURES

### CX 01 MIF /MIM

- **For high quality video signal transmission**, with **HDMI Type A** connectors (19-pole + shield).
- Supports **HDMI™** 1.4 and 2.0 standards (HDMI = High Definition Multimedia Interface), full Ultra HD 4k@60 Hz, 4096x2160p resolution.
- **Supports Ethernet** up to and including 18Gb/s.
- Supports ARC (Audio Return Channel).
- EN/IEC 61984 ratings:  
**0,5 A 40 V 0,8 kV 3**
- NOTE – As a connector with extra-low voltage rating, it is out of the scope of the EU Low Voltage Directive 2014/35/EU and of the Russian equivalent Technical Regulation TR CU 004/2011, hence neither the **CE** marking nor the EAC mark are applicable.
- Lower and Upper Limiting Temperatures (LLT ... ULT):  
-40 °C ... +70 °C.
- Female HDMI module CX 01 MIF hosts a female/female PCB assembly with female HDMI Type A connector on both sides, to act as a coupler between two male terminated patch cords (one on the rear of this female module, one hosted in the male module adapter on the counterpart connector).
- Male HDMI module CX 01 MIM is an adapter able to host a patch cord terminated with HDMI Type A plugs of compact size, providing a latch to anchor the cable.
- It is mandatory to use the male module **CX 01 MIM** with **CW 2 MIAM** 2 m patch cord, provided with slim sized HDMI Type A male plug at both ends and dedicated cable clamp.
- It is mandatory to use the female module **CX 01 MIF** with **CW 2 MIAF** patch cord, twin to the **CW 2 MIAM**, but without cable clamp.
- Connection through pre-assembled (overmoulded) patch cords terminated with slim sized HDMI Type A plug connectors.
- NOTE – For other patch cord length please contact ILME commercial offices.

locking of the  
HDMI male  
plugs through  
a dedicated  
module

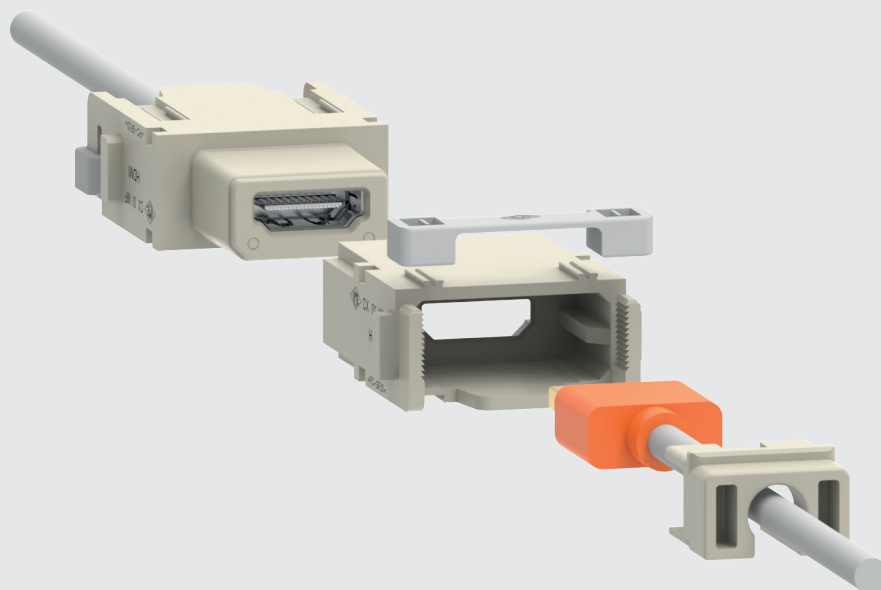

# CX 01 MIF /MIM HDMI Type A connector

The modular inserts must be installed in suitable frames which are then mounted in traditional housings or in COB panel support. Single-sized modular units may be directly mounted inside MIXO ONE enclosures.

pages:

frames for modular units 316 - 317

enclosures: see NOTE 1)

refer to CN.19 pages

HDMI Type A modular units, female-female connector module for male connector

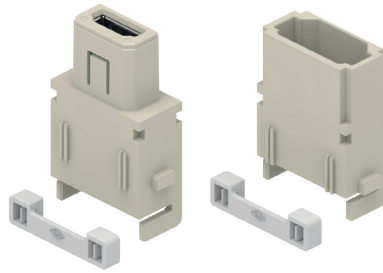

HDMI Type A patch cords

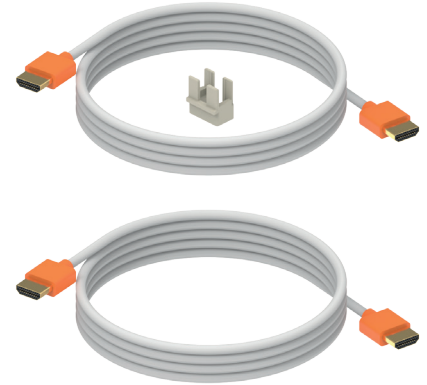

description	part No.	part No.
female/female HDMI Type A connector module for male connector	<b>CX 01 MIF</b>	
patch cord 2 m for female module 2)		<b>CW 2 MIAF</b>
patch cord 2 m with cable clamp for male module 3)		<b>CW 2 MIAM</b>

1) **NOTE**  
Due to the reduced electrical engagement length of the HDMI standard, it is needed to install these modules in enclosures combinations that allow to couple the two MIXO frames within 20,5 mm between the fixing points. Therefore we recommend to install them using the following enclosures:  
- V-TYPE housings coupled with metal hoods  
- T-TYPE enclosures with PE jumpers  
- MIXO ONE enclosures  
- COB

2) With the female module, **CX 01 MIF**, it is mandatory to use the **CW 2 MIAF** patch cord, twin of the CW 2 MIAM but without the cable clamp.

3) With the male module, **CX 01 MIM**, it is mandatory to use the **CW 2 MIAM** patch cord, supplied with a specific cable clamp, tailored to fit the outline of the HDMI connector.

See next page for the assembly instructions.

- characteristics according to EN/IEC 61984 ratings:  
**0,5 A 40 V 0,8 kV 3**

- (ECBT2.E115072, ECBT8.E115072),   
- certified

- BV pending
- temperature range: from -40 °C to +70 °C
- for high quality video signal transmission, with HDMI Type A connectors (19-pole + shield)
- supports HDMI 1.4 and 2.0 standards (HDMI = High Definition Multimedia Interface), full Ultra HD 4k@60 Hz, 4096 x 2160p resolution
- supports Ethernet up to and including 18 Gb/s
- supports ARC (Audio Return Channel)

we recommend the use of CRF / CRM code pins together with relevant MIXO frame

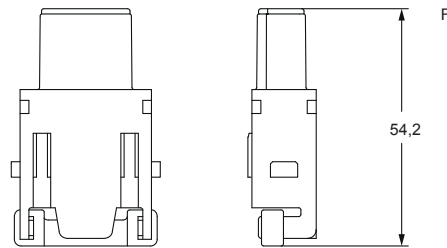
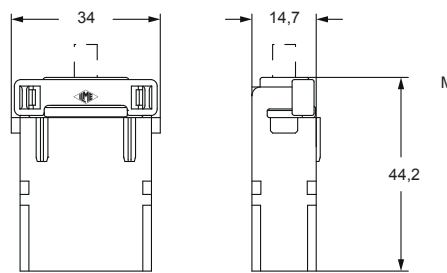

contacts side (front view)

side with reference arrow ▲

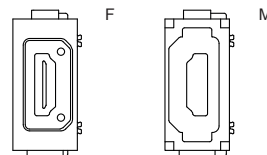

- 1 frame slot

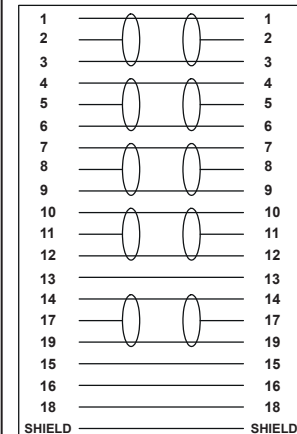
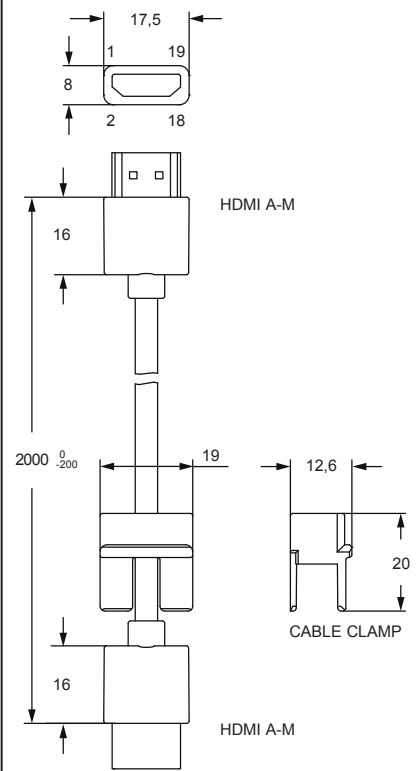

## ASSEMBLY INSTRUCTIONS

### FEMALE MODULE

TO FIX  
CX 01 MIF

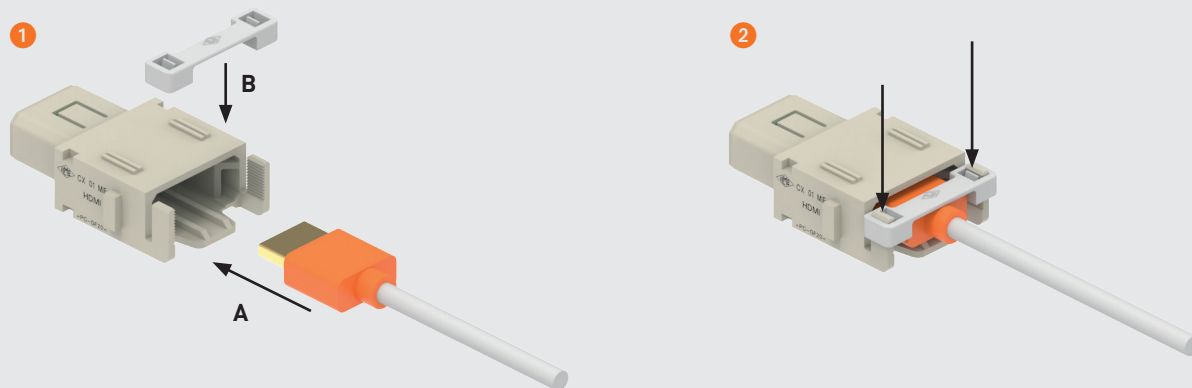

TO REMOVE  
CX 01 MIF

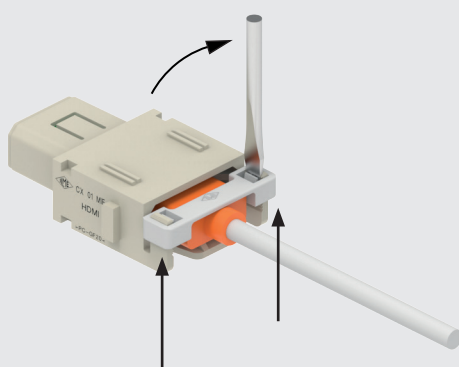

### MALE MODULE

TO FIX  
CX 01 MIM

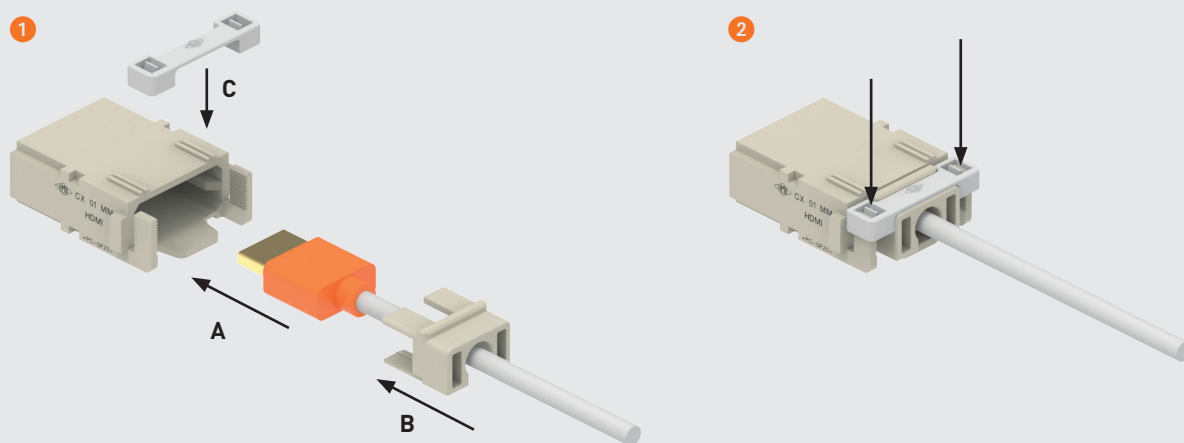

TO REMOVE  
CX 01 MIM

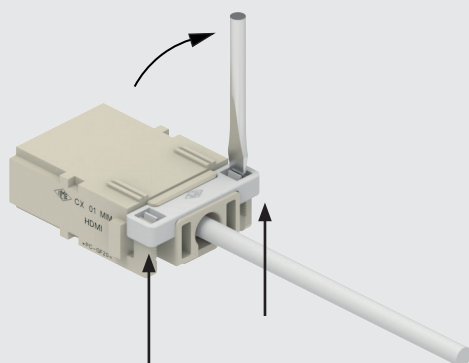

---

**MIXO RJ45 CAT. 6<sub>A</sub>**  
**FEMALE MODULE WITH IDC TERMINATIONS**  
**CX 01 J8AIF /J8BIF /J8PIF**

---

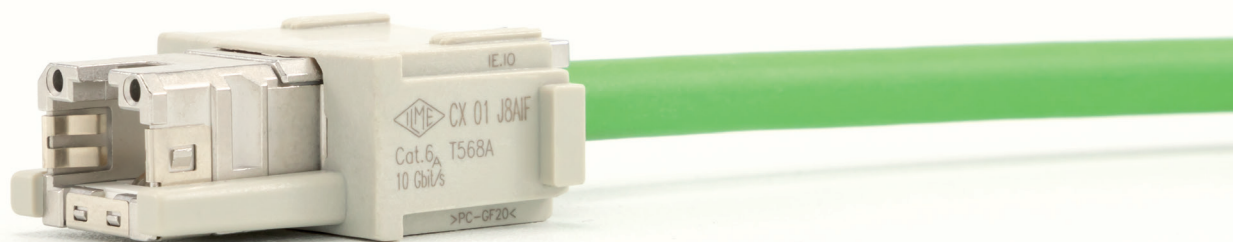

**MIXO RJ45**

8-way shielded jack (female connector)

with IDC terminations for 4-pair data connector Cat. 6<sub>A</sub> Class E<sub>A</sub>

EN/IEC 61984 ratings: 1 A 50 V 0,8 kV 3

## TECHNICAL FEATURES

### CX 01 J8AIF /J8BIF /J8PIF

- RJ45, 8-way shielded jack (female connector) in a MIXO single module format, **with IDC terminations**, 4-pair data connector Cat. 6<sub>A</sub> Class E<sub>A</sub>, for transmission rates up to 10 Gbit/s (IEEE 802.3an), for solderless field wiring.
- It widens the portfolio of ILME RJ45 modular connectors, as an alternative to use the female/female RJ-45 coupler module **CX 01 J8F** rear coupled to a plug of an RJ45 patch cord.
- EN/IEC 61984 ratings: 1 A 50 V 0,8 kV 3  
NOTE – As a connector with extra-low voltage rating, it is out of the scope of the EU Low Voltage Directive 2014/35/EU and of the Russian equivalent Technical Regulation TR CU 004/2011, hence neither the C€ marking nor the EAC mark are applicable.
- Lower and Upper Limiting Temperatures (LLT ... ULT):  
-40 °C ... +85 °C  
NOTE – The limitation to the ULT is set upon the usual temperature rating of the telecommunication cables (2x2-pair or 1x4-pair).
- Can be coupled to the existing MIXO plug module **CX 01 J8IM** or to the **CX 8 J6IM** RJ45 modular connector with IDC terminations, or to the **CX 01 J8M** module with **CX 8 J6M** crimp connector (or to suitable patch cords with RJ45 plug).
- Available for three different pin assignments:
  - CX 01 J8AIF for **TIA 568A** wiring,
  - CX 01 J8BIF for **TIA 568B** wiring (pairs 2 and 3 swapped),
  - CX 01 J8PIF for **PROFINET** wiring.
- Suitable also for MIXO ONE enclosures.

**3 different pin assignments:**  
**-A** for TIA 568A wiring  
**-B** for TIA 568B wiring (pairs 2 and 3 swapped)  
**-P** for PROFINET wiring

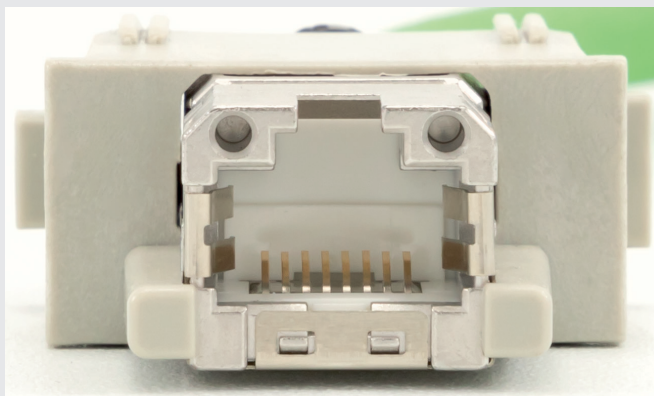

# CX 01 J8AIF / J8BIF / J8PIF RJ45, 8-way shielded jack

The modular inserts must be installed in suitable frames which are then mounted in traditional housings or in COB panel support. Single-sized modular units may be directly mounted inside MIXO ONE enclosures.

pages:

frames for modular units 316 - 317

MIXO ONE enclosures 369

refer to CN.19 pages

## RJ45 8-way female connectors

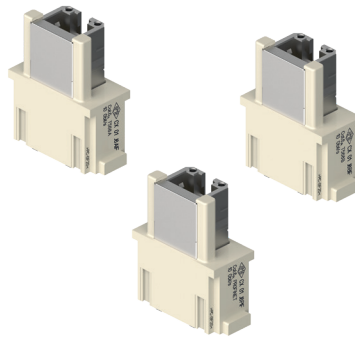

description

part No.

female insert with one RJ45 female IDC connector; contact coding according to:

- TIA 568A
- TIA 568B
- PROFINET

**CX 01 J8AIF**  
**CX 01 J8BIF**  
**CX 01 J8PIF**

- characteristics according to EN/IEC 61984 ratings:

**1 A 50 V 0,8 kV 3**

- certified (ECBT2.E115072, ECBT8.E115072),  certified

- BV pending

- rated voltage according to UL/CSA: 50 V

- made of self-extinguishing thermoplastic resin UL 94V-0

- Lower and Upper Limiting Temperatures (LLT ... ULT): -40 °C ... +85 °C

- we recommend to fix the cable with cable tie

## CX J8AIF/J8BIF/J8PIF

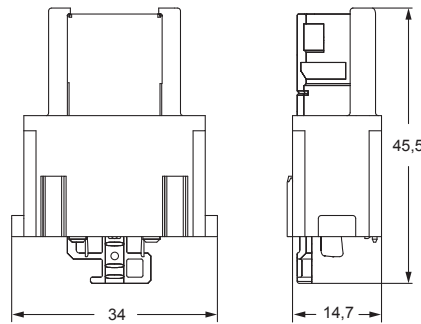

contacts side (front view)

side with reference arrow ▲

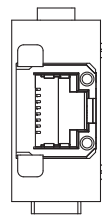

- 1 frame slot

## CX 01 J8AIF / J8BIF / J8CIF technical data:

- RJ45 female IDC connector Cat. 6<sub>A</sub> Class E<sub>A</sub>
- adequate for Power over Ethernet+ (PoE+) according to IEEE 802.3at
- connector: IEC 60603-7-51
- adequate for 10 Gigabit Ethernet acc. to IEEE 802.3an
- custom-designed cabling systems: PROFINET Installation Guideline
- generic cabling systems: ANSI/TIA/EIA-568-C.2 ISO/IEC 11801 EN 50173-1 ISO/IEC 24702 EN 61918
- custom-designed cabling systems: according to PROFINET Installation Guideline
- Class E<sub>A</sub> (channel): ISO/IEC 11801, EN 50173-1
- Category 6<sub>A</sub> (component): ISO/IEC 11801; DIN EN 50173-1
- Category 6A: ANSI/TIA/EIA-568-C.2
- shielding housing: zinc die cast
- housing finish: CuSnZn
- current carrying capacity at 50 °C: 1 A
- durability (mating cycles): ≥750
- Cu-conductor diameter: solid: 0,40 – 0,64 mm (AWG 26/1 – 22/1) stranded: 0,48 – 0,76 mm (AWG 26/7 – 22/7)
- insulation diameter (cores): 0,85 – 1,6 mm (0.034 – 0.063 in)
- cable diameter: 5,5 – 9 mm
- IDC: CuNi2Si
- IDC finish: 3-6 μm Sn



Watch our online tutorial

## PIN ASSIGNMENT

### CX 01 J8AIF

PIN assignment T568A according to TIA/EIA 568-C.2

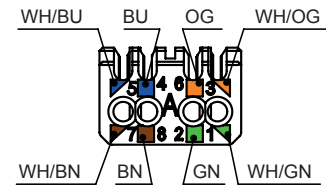

### CX 01 J8BIF

PIN assignment T568B according to TIA/EIA 568-C.2

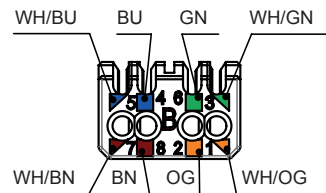

### CX 01 J8PIF

PIN assignment Profinet / Industrial

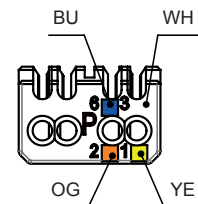



**MIXO RJ45 CAT. 6<sub>A</sub> - FEMALE MODULE WITH IDC TERMINATIONS**  
**CX 01 J8AIF /J8BIF /J8PIF**

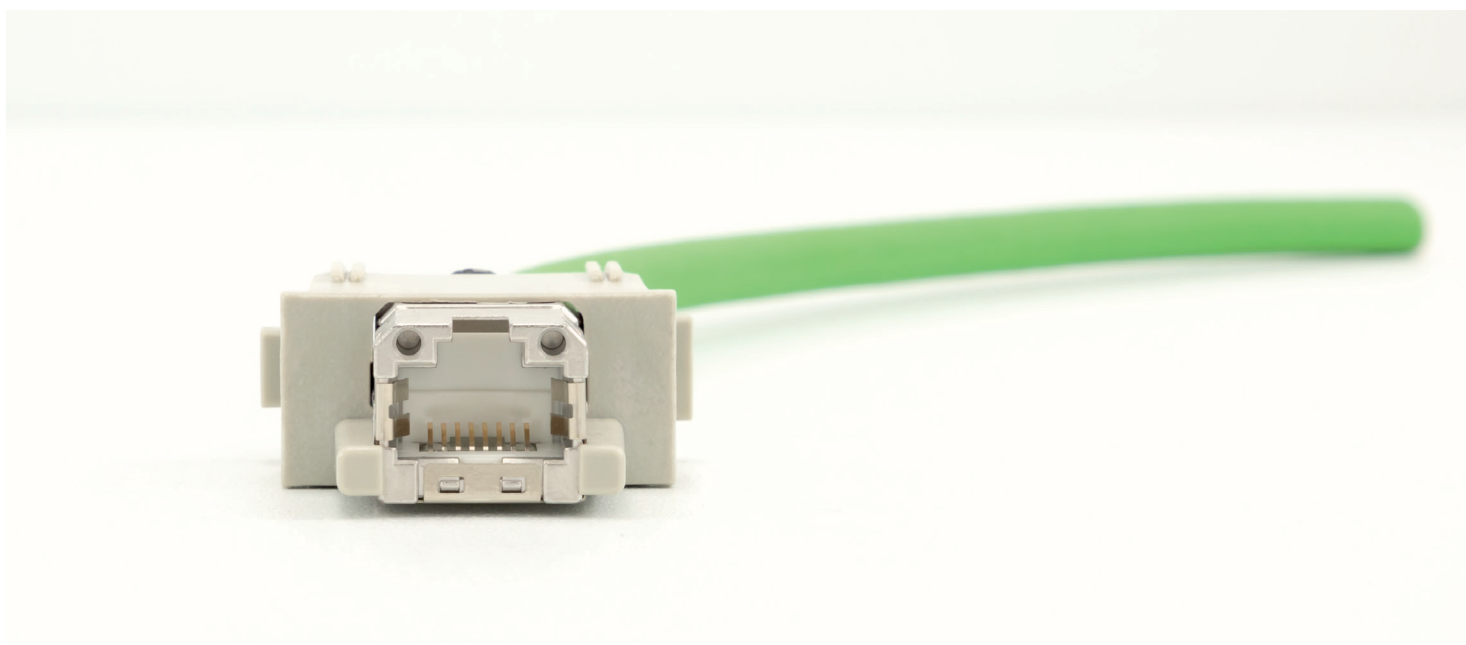

---

**MIXO HT MODULE 40A 2 POLES**  
**CX 02 4HF /4HM**

---

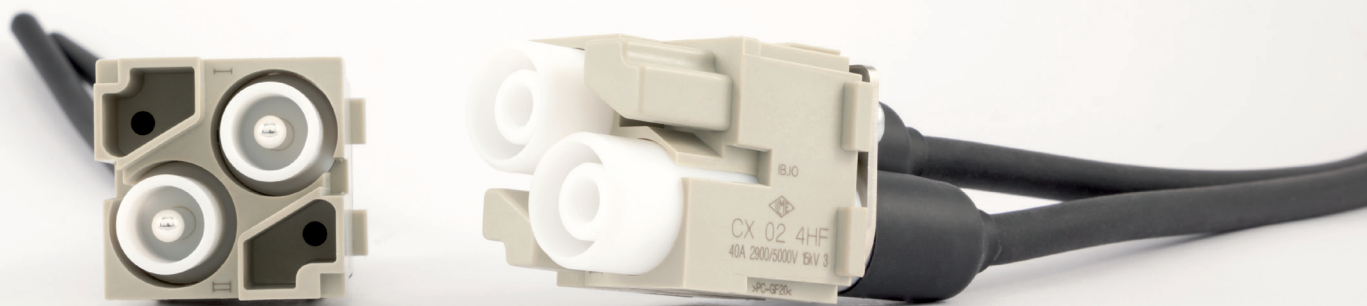

2-pole MIXO double-sized module  
for high tension and higher current needs  
EN/IEC 61984 ratings:  
2 P 40 A 2900/5000 V 15 kV 3



Find more  
information on  
our products at  
[www.ilme.com](http://www.ilme.com)

## TECHNICAL FEATURES

### CX 02 4HF /4HM

- 2-pole MIXO double-sized module for **high tension** and **higher current needs**, respectively up to 2 900/5 000 V and up to 40 A per pole.
- It widens the portfolio of series **MIXO HT** (high tension) connector modules, adding to the 16 A HT modules **CX 02 HF/HM** (double-sized module) and **CX 02 CHF/CHM** (single-sized module).
- It hosts 2 crimp contacts series **CX** (40 A), separately available, sizes 1.5 through 10 (1,5 mm<sup>2</sup> / 16 AWG through 10 mm<sup>2</sup> / 8 AWG).
- Allowed sheathing Ø of high tension wire: 9,0 mm max
- EN/IEC 61984 ratings\*:  
**2 P 40 A 2900/5000 V 15 kV 3**

NOTE – As a connector with high voltage rating, it is out of the scope of the EU Low Voltage Directive 2014/35/EU and of the Russian equivalent Technical Regulation TR CU 004/2011, hence neither the C€ marking nor the EAC mark are applicable.

\* EN/IEC 61984 used as a guide

- Lower and Upper Limiting Temperatures (LLT ... ULT):  
-40 °C ... +125 °C

- Insulator sleeves made by high voltage resistant PTFE, connector body made by polycarbonate, both materials UL 94V-0 self-extinguishing.

- 2 heat shrinking tubes provided to ensure correct insulation on the rear of the insulator sleeves holding the wired contacts.

- Possible combination with all other MIXO modules (low-voltage power, signal, pneumatic, fibre optics).

insulator sleeves made  
by high voltage resistant  
PTFE, connector body  
made by polycarbonate,  
both materials UL 94V-0  
self-extinguishing

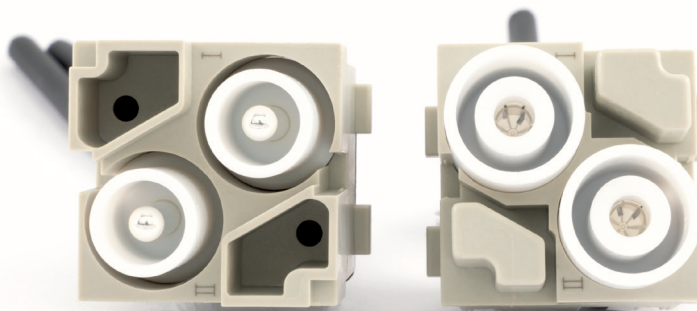

# CX 02 4HF/4HM HT 2 poles 40 A - 2900/5000 V

The modular inserts must be installed in suitable frames, which are then mounted in traditional enclosures\* or in COB panel supports.

pages:

frames for modular units\* 316

\* enclosures: bulkhead mounting housings, high construction housings or high construction hoods

refer to CN.19 pages

high voltage modular units,  
crimp connections  
contact holder removal tool

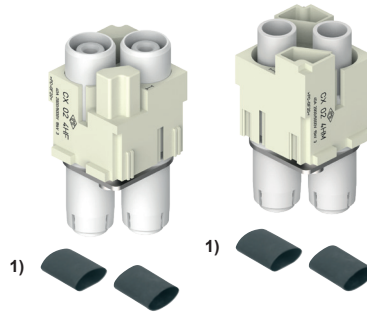

40 A silver plated crimp contacts



description	part No.	part No.
without contacts (to be ordered separately)		
high voltage female insert for female contact	<b>CX 02 4HF</b>	
high voltage male insert for male contact	<b>CX 02 4HM</b>	
contact holder removal tool 2)	<b>CHES</b>	
40A female crimp contacts		<b>CXFA 1.5</b>
1,5 mm <sup>2</sup> AWG 16		<b>CXFA 2.5</b>
2,5 mm <sup>2</sup> AWG 14		<b>CXFA 4.0</b>
4 mm <sup>2</sup> AWG 12		<b>CXFA 6.0</b>
6 mm <sup>2</sup> AWG 10		<b>CXFA 10</b>
10 mm <sup>2</sup> AWG 8		
40A male crimp contacts		<b>CXMA 1.5</b>
1,5 mm <sup>2</sup> AWG 16		<b>CXMA 2.5</b>
2,5 mm <sup>2</sup> AWG 14		<b>CXMA 4.0</b>
4 mm <sup>2</sup> AWG 12		<b>CXMA 6.0</b>
6 mm <sup>2</sup> AWG 10		<b>CXMA 10</b>
10 mm <sup>2</sup> AWG 8		

silver plated

- 1) supplied with heat shrink insulating tubes for the rear of the contacts
- characteristics according to EN/IEC 61984 ratings 3):  
**40 A 2900/5000 V 15 kV 3**
- 3) used for guidance as applicable
- (ECBT2.E115072, ECBT8.E115072),
- certified
- BV pending
- insulation resistance: ≥ 10 GΩ
- Lower and Upper Limiting Temperatures (LLT ... ULT):  
-40 °C ... +125 °C
- made of self-extinguishing thermoplastic resin  
UL 94V-0
- mechanical life: ≥ 500 cycles
- contact resistance: ≤ 0,3 mΩ
- **it is recommended to crimp the contacts with crimping tools homologated by ILME** (please see the crimping tool section 40 A contacts, CXF and CXM series) on pages 708 - 741 of CN.19 catalogue).  
For 40 A contacts see also new pneumatic crimping tool CCPZP RN (see page 145)
- contact holder removal tool: **CHES** 2)

CHES



### CX 02 4HF, CX 02 4HM

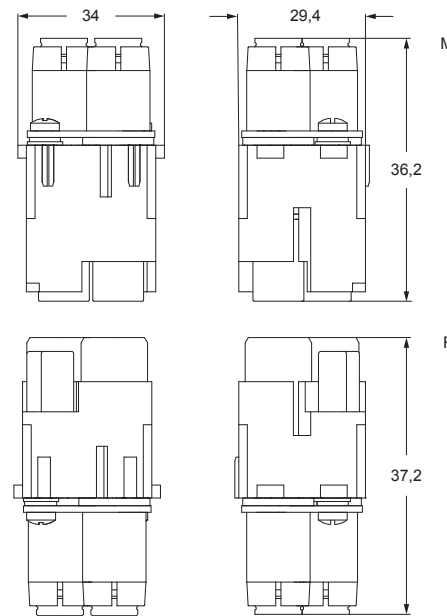

contacts side (front view)  
side with reference arrow ▲

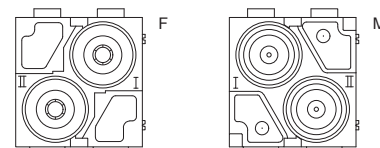

- 2 frame slots

### CXF and CXM

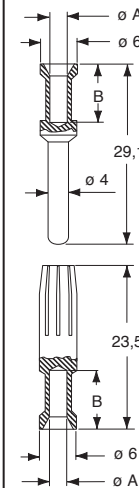

### CXF and CXM contacts

conductor section (mm <sup>2</sup> )	conductor slot (mm)	conductor stripping length (mm)
1,5	1,8	9
2,5	2,2	9
4	2,85	9,6
6	3,5	9,6
10	4,3	15

## ASSEMBLY INSTRUCTIONS

### CX 02 4HF/4HM - CONTACT HOLDER INSERTION

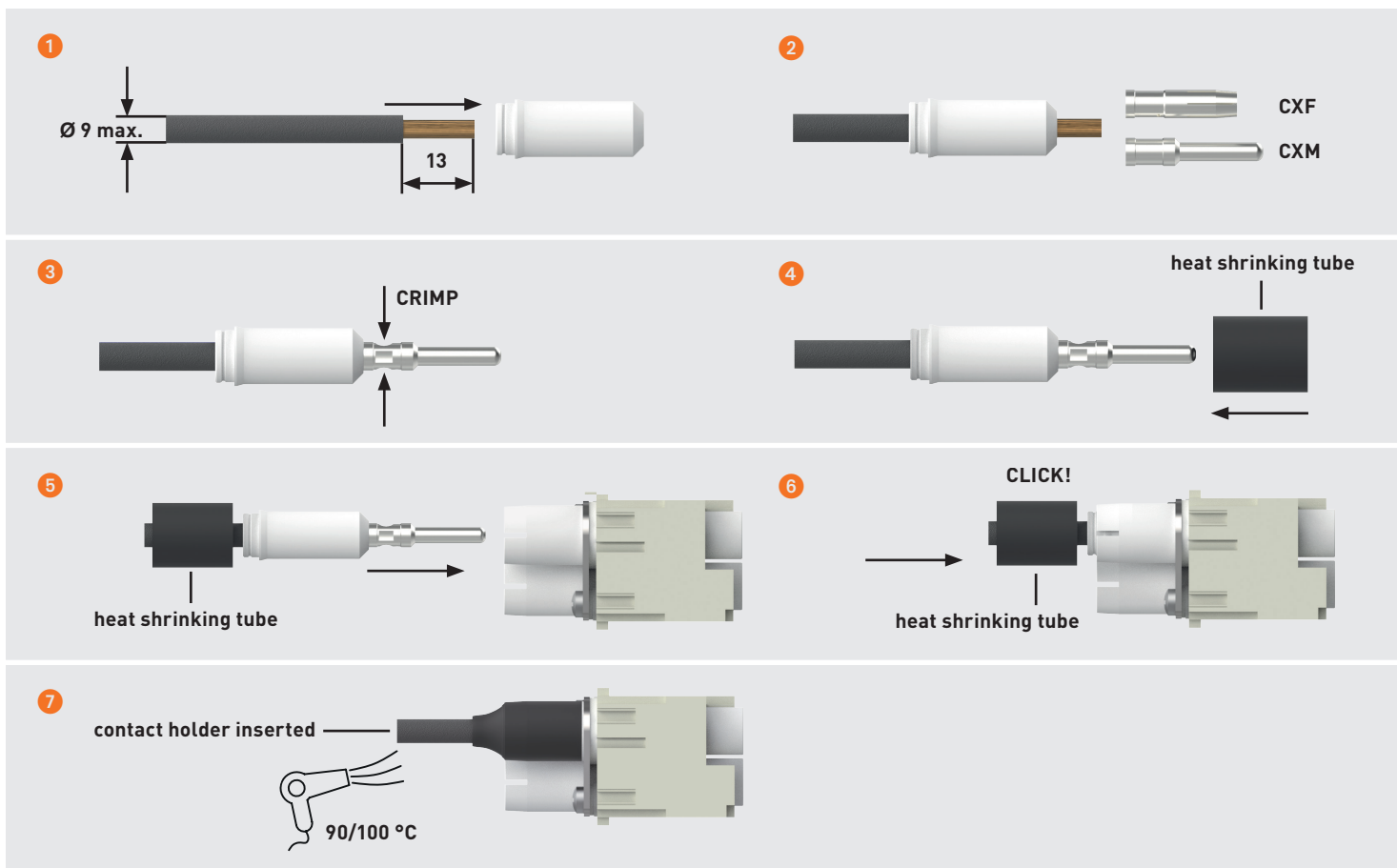

### CX 02 4HF/4HM - CONTACT HOLDER REMOVAL

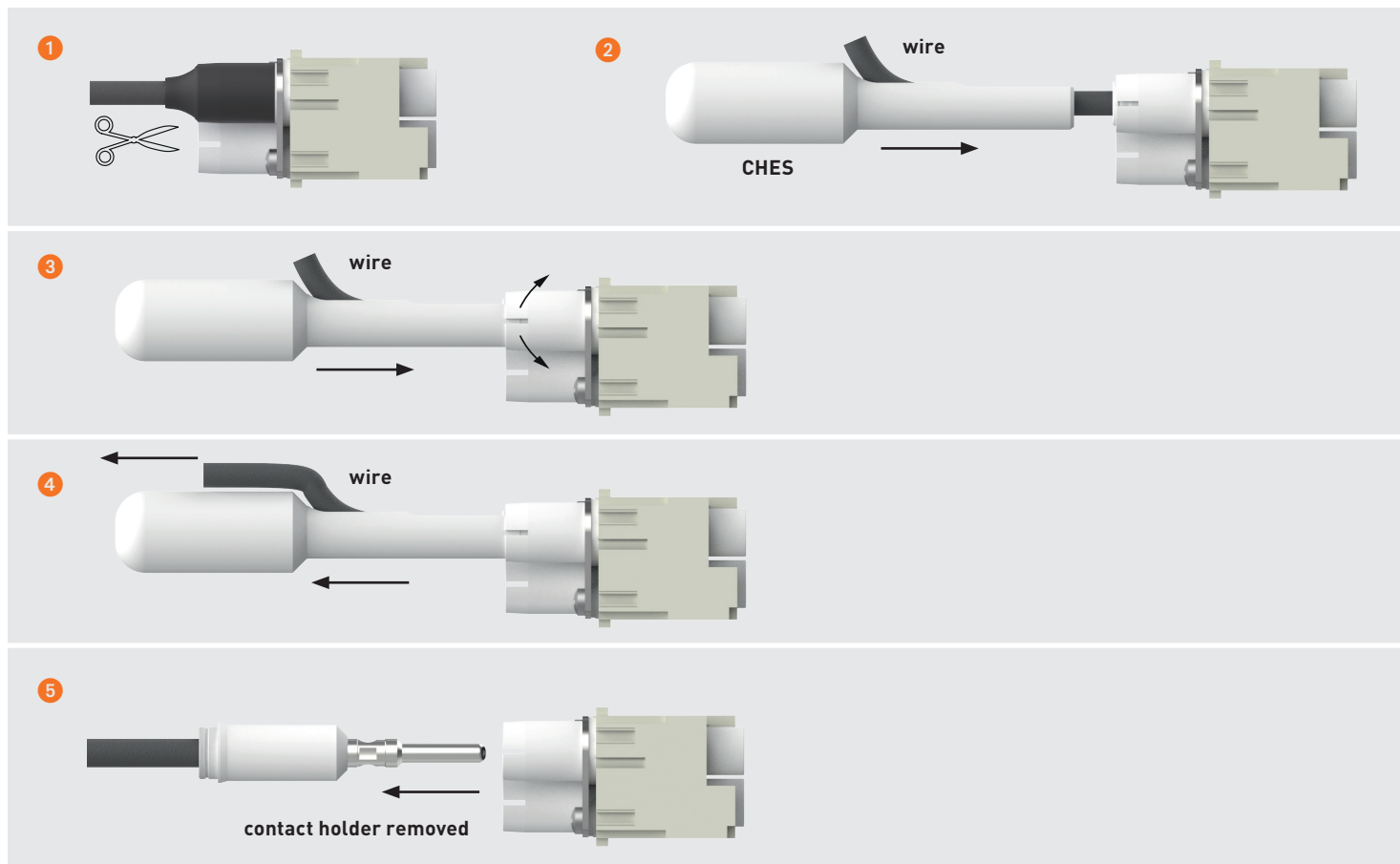

---

**MIXO 9-POLE SHIELDED  
D-SUB MODULE FOR 2 CABLES  
CX 01 9VF2 /9VM2**

---



MIXO 9-pole D-Sub  
shielded connector module for 2 cables  
EN/IEC 61984 ratings:  
5 A 50 V 0,8 kV 3



Find more  
information on  
our products at  
[www.ilme.com](http://www.ilme.com)

## TECHNICAL FEATURES

### CX 01 9VF2 /9VM2

- Allows the connection of the 9-pole D-Sub shielded connector **using two separate cables** (thanks to a double cable clamp on the shield).
- **Clamp for 2 cables** max Ø 6,0 mm.
- Adds to the currently available **CX 01 9VF /9VM** shielded 9-pole D-Sub module for single cable.
- 9-pole D-Sub connector for turned removable crimp contacts series **CI** or the new **SI** series stamped crimped contacts up to size 0.5.
- Shield separated from the PE circuit (MIXO frame).
- EN/IEC 61984 ratings: **5 A 50 V 0,8 kV 3**  
NOTE – As a connector with extra-low voltage rating, it is out of the scope of the EU Low Voltage Directive 2014/35/EU and of the Russian equivalent Technical Regulation TR CU 004/2011, hence neither the C€ marking nor the EAC mark are applicable.
- Lower and Upper Limiting Temperatures (LLT ... ULT):  
-40 °C ... +85 °C  
NOTE - The limitation to the ULT is set upon the usual temperature rating of the data cables, the insulating materials of the inserts and the metal shield might withstand up to 125 °C.
- Fixing screws Ph1, coupling torque 1 Nm.
- Suitable also for MIXO ONE enclosures.

the double cable clamp  
on the shield allows  
the connection of the  
9-pole D-Sub shielded  
connector using two  
separate cables

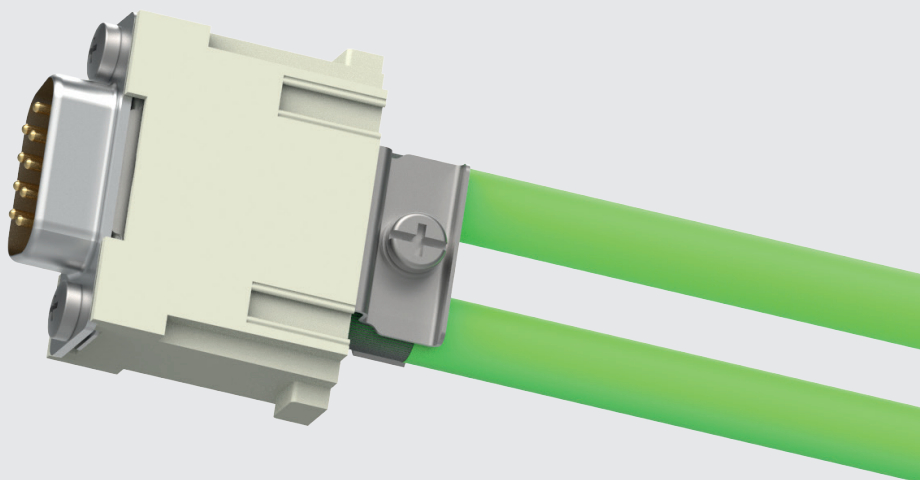



# CX 01 9VF2 /9VM2 9-pole crimp D-SUB shielded connector

The modular inserts must be installed in suitable frames which are then mounted in traditional enclosures\* or in COB panel support.  
Single-sized modular units may be directly mounted inside MIXO ONE enclosures.

pages:

frames for modular units\* 316 - 317

MIXO ONE enclosures 369

\* enclosures:  
housings or high construction hoods

refer to CN.19 pages

module adapter with 1 D-SUB connector  
double cable entry

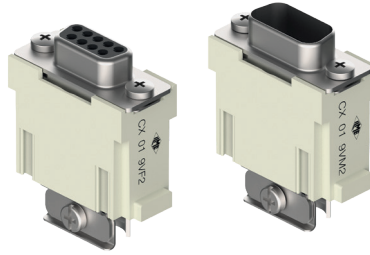

CI (5 A) crimp contacts for D-SUB  
gold plated



description

part No.

part No.

seat for 1 D-SUB crimp contacts connector and shield  
(included)

female insert with connector  
male insert with connector

CX 01 9VF2  
CX 01 9VM2

CI (5 A) female crimp contacts  
0,08-0,21 mm<sup>2</sup> AWG 28-24  
0,13-0,33 mm<sup>2</sup> AWG 26-22  
0,33-0,52 mm<sup>2</sup> AWG 22-20

CIFD 0.2  
CIFD 0.3  
CIFD 0.5

CI (5 A) male crimp contacts  
0,08-0,21 mm<sup>2</sup> AWG 28-24  
0,13-0,33 mm<sup>2</sup> AWG 26-22  
0,33-0,52 mm<sup>2</sup> AWG 22-20

CIMD 0.2  
CIMD 0.3  
CIMD 0.5

gold plated+

- characteristics according to EN/IEC 61984 ratings:

**5 A 50 V 0,8 kV 3**

- DNV, BV pending
- Lower and Upper Limiting Temperatures (LLT ... ULT):  
-40 °C ... +85 °C
- mechanical life: ≥ 500 cycles
- contact resistance: ≤ 4 mΩ
- for crimp contacts CI series use:

**CIPZ D** crimping tool

**CIPZP D** pneumatic crimping tool (see page 144)

**CITP D** turret head

**CIVES** insertion / removal tool for contacts 0,2 - 0,5 mm<sup>2</sup>  
(see pages 716 - 719 of CN.19 catalogue)

**Warnings:**

We recommend the use of coding pins

**CRF CX / CRM CX** (see pages 685 - 686 of CN.19 catalogue).

CRF CX  
CRM CX

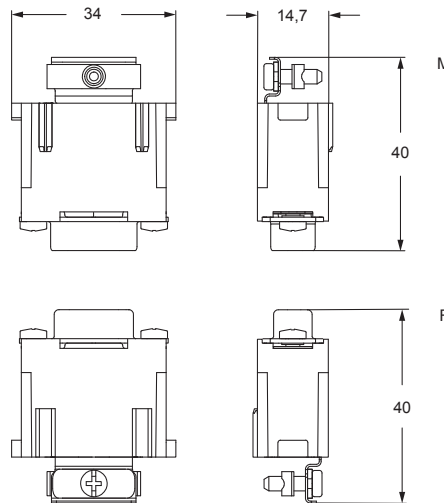

contacts side (front view)

side with reference arrow ▲

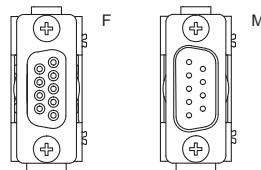

- 1 frame slot

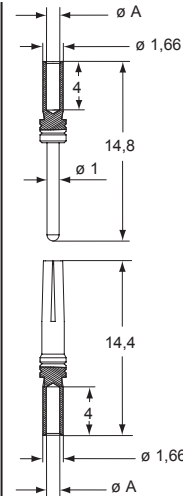

**CIF and CIM contacts**

conductor section (mm <sup>2</sup> )	conductor slot $\varnothing A$ (mm)	conductors stripping length (mm)
0,08-0,21	0,64	4
0,13-0,33	0,90	4
0,33-0,52	1,12	4

\* for basic or high thickness gold plating, please refer to page 74

# ASSEMBLY INSTRUCTIONS

## MIXO 9-POLE SHIELDED D-SUB MODULE FOR 2 CABLES - CX 01 9VF2 /9VM2



Watch our online tutorial

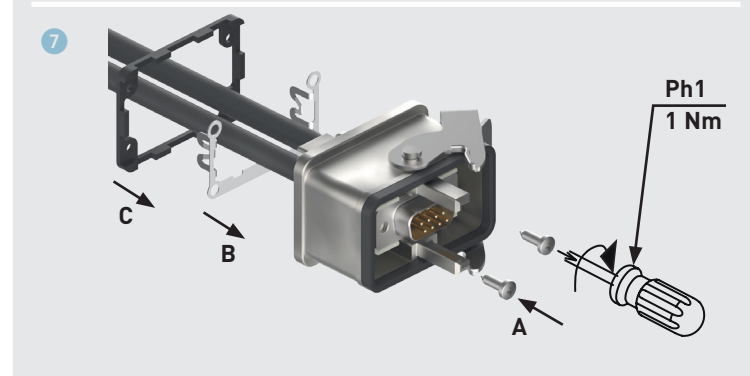
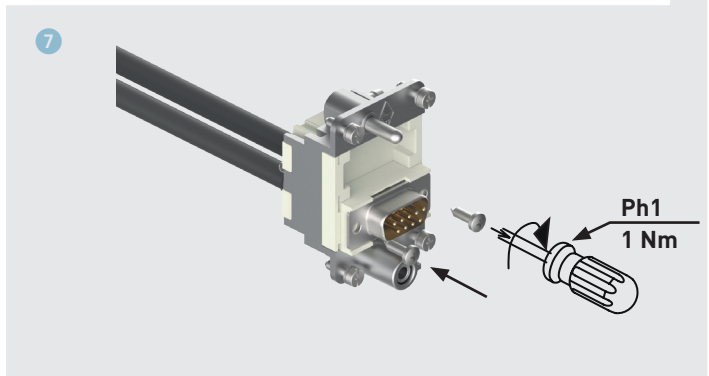
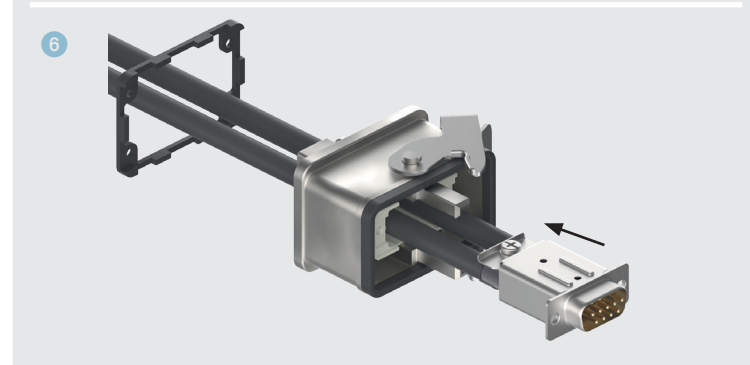
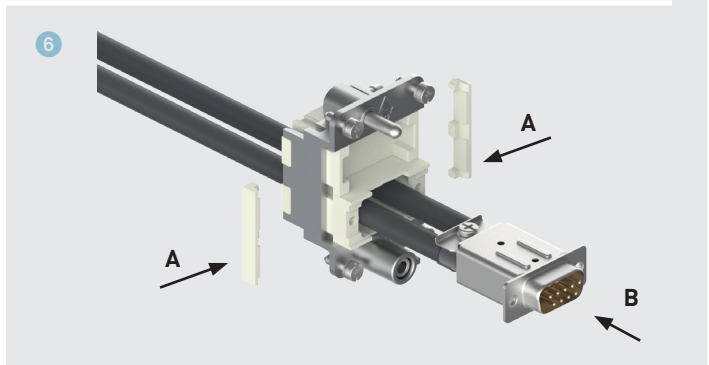
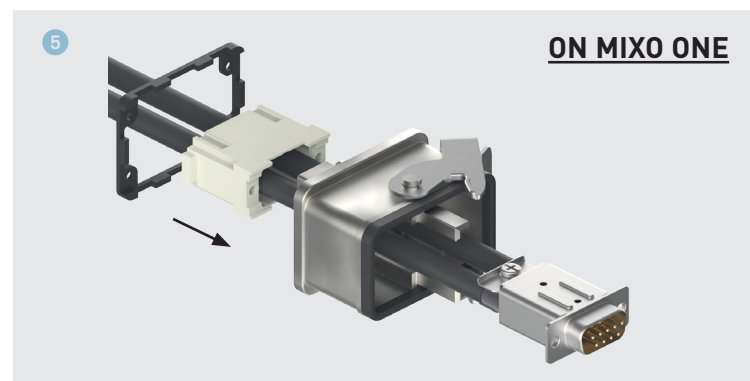
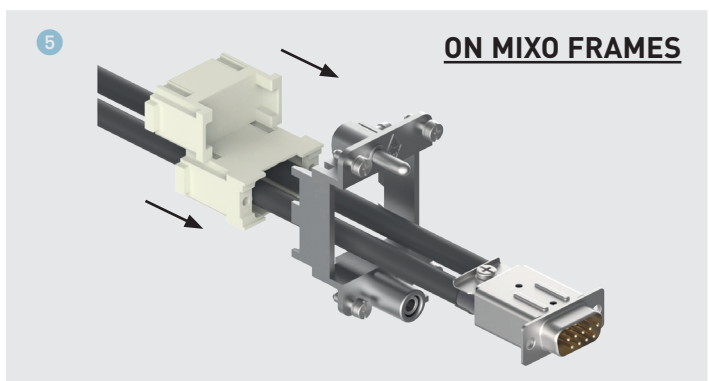
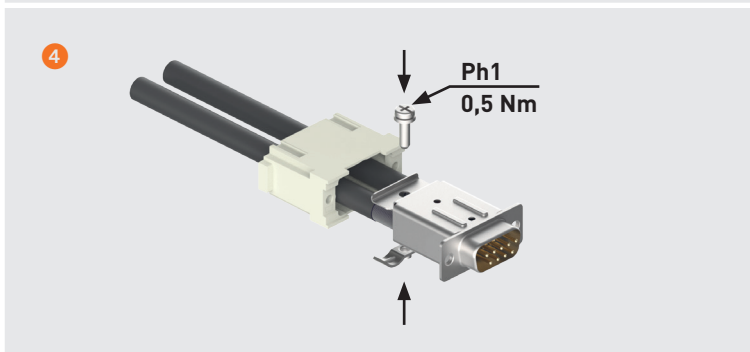
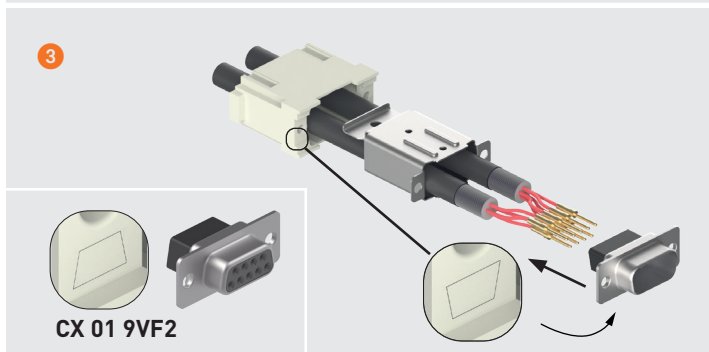
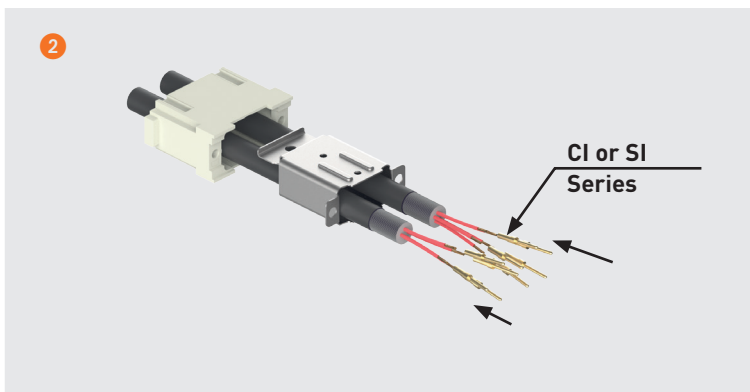
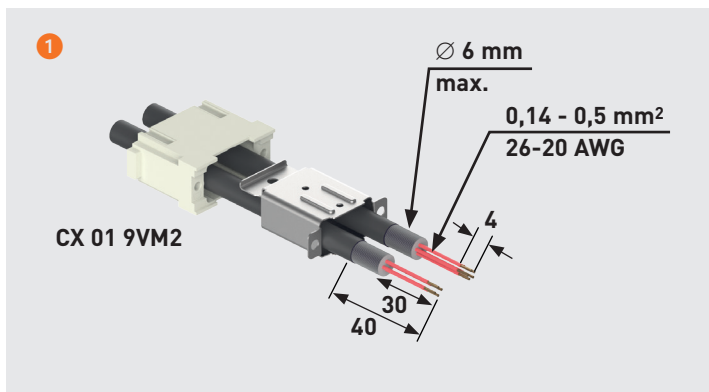

---

**CI SERIES CRIMP CONTACTS (5 A)**  
**BASIC GOLD PLATING**  
**HIGH THICKNESS GOLD PLATING**

---



**5 A crimp contacts**  
**with basic gold plating,**  
**with high thickness gold plating**



Find more  
information on  
our products at  
[www.ilme.com](http://www.ilme.com)

## TECHNICAL FEATURES

### CIF2D /CIM2D 0.2/0.3/0.5/0.7 - CIFJD /CIMJD 0.2/0.3/0.5/0.7

Contacts gold plating in electrical connectors is particularly indicated for noiseless transmission of sensitive signals, thanks to the low contact resistance and the reduced galvanic potential that this plating provides.

To complete the offer of turned crimp contacts of series **CI** (5 A) pairing it to that already available for series **CD** (10 A) and **CC** (16 A) (see CN.19 pages 674-675), also series **CI** (5 A) is now **available with two additional gold platings:**

- a **basic gold plated** version, provided with a low thickness gold plating over a high thickness substrate of nickel-phosphorus, identified by “**JD**” in the first portion of their part no. (**CIFJD/CIMJD**);
- a **high thickness gold plated** version, provided with a 2µm gold plating over a substrate of nickel, identified by “**2D**” in the first portion of their part number (**CIF2D/CIM2D**).

Both series are already approved with the  mark in files ECBT2.E115072 and ECBT8.E115072.

All versions of series **CI** – like the equivalent versions already available for series **CD** (10 A) and series **CC** (16 A) turned crimp contacts – comply with the RoHS 2 EU Directive with exemption 6c (lead as alloying element in copper alloys).

The **basic gold plated** version (version “**JD**”) is an economical alternative to the “**D**” standard gold plated version of series **CI (CIFD/CIMD)** that, by employing a special nickel-phosphorus hard and durable plating substrate, maintains the corrosion resistance (tested according EN 60068), the mechanical life (≥500 mating cycles) and the full compliance to the connectors’ safety standard EN 61984:2009, that uses test methods of series **IEC 60512**, and to the crimped connection standard EN 60352-2:1994 (Ed.1.0 more demanding for turned contacts in terms of pull-out force) at the same level of the standard gold plated version **CIFD/CIMD**.

The second, **high thickness gold plated** version (version “**2D**”) expands the performance of the “**D**” standard gold plated version of series **CI (CIFD/CIMD)** by using a high thickness gold plating over the usual migration barrier nickel plating substrate, for those harsher applications that demand the lowest porosity of the gold plating even after sustained number of mating cycles (up to 500 and more) in corrosive environments.

# CIF2D /CIM2D - CIFJD /CIMJD 5 A

**inserts**

<b>CQ 21</b>	21 poles	<b>190</b>
<b>CX 08 B (MIXO BUS)</b>	8 poles + shield	<b>293</b>
<b>CX 08 I6 (MIXO DATA)</b>	8 poles	<b>286</b>
<b>CX 25 IB (MIXO)</b>	25 poles	<b>284</b>
<b>CX 36 I (MIXO)</b>	36 poles	<b>30 *</b>
<b>CX 20S I (MIXO)</b>	20 poles + shield	<b>36 *</b>
<b>CX 01 9V (MIXO DATA)</b>	9 poles + shield	<b>296</b>
<b>CX 01 9V 2 (MIXO DATA)</b>	9 poles + shield	<b>70 *</b>

pages:

**5 A crimp contacts  
high thickness gold plated**



**5 A crimp contacts  
basic gold plated**



refer to CN.19 pages  
\* refer to NEWS 2020 pages

description	part No.	part No.
CI (5 A) female crimp contacts		
0,08-0,21 mm <sup>2</sup> AWG 28-24	<b>CIF2D 0.2</b>	<b>CIFJD 0.2</b>
0,13-0,33 mm <sup>2</sup> AWG 26-22	<b>CIF2D 0.3</b>	<b>CIFJD 0.3</b>
0,33-0,52 mm <sup>2</sup> AWG 22-20	<b>CIF2D 0.5</b>	<b>CIFJD 0.5</b>
0,52-0,75 mm <sup>2</sup> AWG 20-18	<b>CIF2D 0.7</b>	<b>CIFJD 0.7</b>
CI (5 A) male crimp contacts		
0,08-0,21 mm <sup>2</sup> AWG 28-24	<b>CIM2D 0.2</b>	<b>CIMJD 0.2</b>
0,13-0,33 mm <sup>2</sup> AWG 26-22	<b>CIM2D 0.3</b>	<b>CIMJD 0.3</b>
0,33-0,52 mm <sup>2</sup> AWG 22-20	<b>CIM2D 0.5</b>	<b>CIMJD 0.5</b>
0,52-0,75 mm <sup>2</sup> AWG 20-18	<b>CIM2D 0.7</b>	<b>CIMJD 0.7</b>

gold plated

gold plated

The gold plated contacts provide:

- corrosion resistance (according to EN 60068)
- mechanical life: ≥ 500 coupling cycles
- in compliance with EN 61984:2009, IEC 60512, EN 60352-2: 1994
- compliant to directive RoHS2
- contact resistance: ≤ 4 mΩ
- for crimp contacts CI series use, on page 716 - 719 of CN.19 catalogue

**CIPZ D** crimping tool

**CIPZP D** pneumatic crimping tool (see page 144)

**CITP D** turret head

**CIES** insertion / removal tool for contacts 0,2 - 0,5 mm<sup>2</sup>

**CIES B** insertion / removal tool for contacts 0,75 mm<sup>2</sup>

- certifications: (UL for USA and Canada),

**NOTE:**

The current rating depends on the contact size and on the connector in which they are installed. See derating diagrams of each connector.

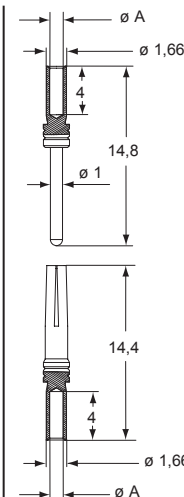
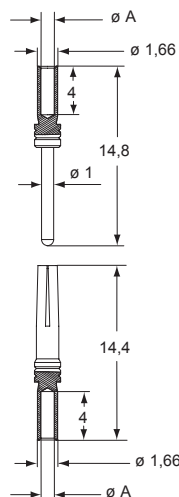

**CIF2D and CIM2D contacts**

conductor section (mm <sup>2</sup> )	conductor slot $\varnothing A$ (mm)	conductors stripping length (mm)
0,08-0,21	0,64	4
0,13-0,33	0,90	4
0,33-0,52	1,12	4
0,52-0,75	1,12	4

**CIFJD and CIMJD contacts**

conductor section (mm <sup>2</sup> )	conductor slot $\varnothing A$ (mm)	conductors stripping length (mm)
0,08-0,21	0,64	4
0,13-0,33	0,90	4
0,33-0,52	1,12	4
0,52-0,75	1,12	4

**CI SERIES CRIMP CONTACTS (5 A) - BASIC GOLD PLATED - HIGH THICKNESS GOLD PLATED**  
**CIF2D /CIM2D 0.2/0.3/0.5/0.7 - CIFJD /CIMJD 0.2/0.3/0.5/0.7**



---

## SI SERIES STAMPED CRIMP CONTACTS (5 A) SIF..D /SIM..D

---



Contacts for wires with  
conductor cross-sectional area:  
28-24 AWG (0,08 – 0,21 mm<sup>2</sup>) and  
24-20 AWG (0,21 – 0,52 mm<sup>2</sup>)



Find more  
information on  
our products at  
[www.ilme.com](http://www.ilme.com)



# TECHNICAL FEATURES

## SIF..D /SIM..D

- Alternative (but not equivalent) to the turned crimp contacts series **CI**, for less demanding applications e.g. reduced current-carrying capacity, not relevant for signal applications (widely used in the D-Sub connector field).
- Available with different **selective gold plating** thickness (over nickel) according to three required performance levels: **1D – 2D – 3D**, respectively for **500**, **250** and **50** mating cycles.
- **Open crimp barrel** contacts **with insulation grip**, providing tensile strength (pull out force) compliant with EN/IEC 60352 Ed. 2, lower than corresponding turned, closed crimp barrel contacts series CI (EN/IEC 60352-2 Ed.1.0 had two different curves A and B, later consolidated in the lower demanding curve B, whereas ILME CI turned contacts still claim conformity to curve A).
- Compatible with inserts **CQ 21**, and MIXO modules **CX 25 IB**, **CX 36 I**, **CX 08 B** (MIXO BUS 8P), **CX 01 9V** (9-pin shielded D-SUB for 1 cable), **CX 01 9V2** (9-pin shielded D-SUB for 2 cables).

**CAUTION** – Only selected inserts are suitable for stamped contacts! Respect the indications provided in the additional catalogue pages (under construction) in combination with these new **SI** stamped contacts.

- Derating diagrams of above inserts / modules are under construction: expected to show ca. 10% less current-carrying capacity than when inserts employ corresponding turned contacts series CI.

NOTE: Not suitable for MIXO Shielded CX 20S IF /IM.

- Available in **2 sizes**:
  - **0.2** for wires with conductor cross-sectional area 28-24 AWG (0,08 – 0,21 mm<sup>2</sup>);
  - **0.5** for wires with conductor cross-sectional area 24-20 AWG (0,21 – 0,52 mm<sup>2</sup>).

- Available in **3 possible packaging** depending on volumes used and associated crimp tooling:
  - as loose parts (no suffix), in 200 pcs per box package, for use with manual crimp tool **SIPZ W**;
  - as coil package (suffix **C**), 500 pcs in a compact-sized coil, for use with manual crimp tools able to host the coil, **SIPZC W**;
  - as reel (bandolier) package (suffix **R**), 10 000 pcs in a large-sized reel, for use with semi-automatic crimping machine.

- Possible performance levels (mating cycles):

PL1 (≥500 cycles)	PL2* (≥250 cycles)	PL3 (≥50 cycles)	mm <sup>2</sup>	AWG
SIF1D 0.2	<b>SIF2D 0.2</b>	SIF3D 0.2	0,08 – 0,21	28 – 24
SIF1D 0.5	<b>SIF2D 0.5</b>	SIF3D 0.5	0,21 – 0,52	24 – 20
SIM1D 0.2	<b>SIM2D 0.2</b>	SIM3D 0.2	0,08 – 0,21	28 – 24
SIM1D 0.5	<b>SIM2D 0.5</b>	SIM3D 0.5	0,21 – 0,52	24 – 20

\* NOTE – **PL2 available on stock**, PL1 and PL3 available upon request.

- Stripping length: **3 mm**

### Environmental conformities:

- RoHS 2: conform without exemptions
- China RoHS: conform without exemption  
– EFUP 50 (years – no marking required)
- REACH SVHC substance: none

# SIF /SIM..D 5 A stamped size 0.2

**inserts**

CQ 21	21 poles	190
CX 08 B (MIXO BUS)	8 poles + shield	293
CX 25 IB (MIXO)	25 poles	284
CX 36 I (MIXO)	36 poles	30 *
CX 01 9V (MIXO DATA)	9 poles + shield	296
CX 01 9V 2 (MIXO DATA)	9 poles + shield	70 *

pages:

**SI..D (5 A) crimp contacts**

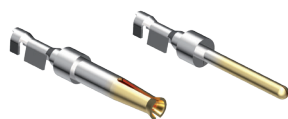

refer to CN.19 pages

\* refer to NEWS 2020 pages

**Q STAMPED CONTACTS**

description	part No.	pcs. (1 packaging unit)
SIF..D ... (5 A) female stamped crimp contacts (loose parts)		200
0,08-0,21 mm <sup>2</sup> AWG 28-24	SIF1D 0.2	
0,08-0,21 mm <sup>2</sup> AWG 28-24	SIF2D 0.2	
0,08-0,21 mm <sup>2</sup> AWG 28-24	SIF3D 0.2	
SIM..D ... (5 A) male stamped crimp contacts (loose parts)		200
0,08-0,21 mm <sup>2</sup> AWG 28-24	SIM1D 0.2	
0,08-0,21 mm <sup>2</sup> AWG 28-24	SIM2D 0.2	
0,08-0,21 mm <sup>2</sup> AWG 28-24	SIM3D 0.2	
SIF..D ... C (5 A) female stamped crimp contacts (coil package)		500
0,08-0,21 mm <sup>2</sup> AWG 28-24	SIF1D 0.2C	
0,08-0,21 mm <sup>2</sup> AWG 28-24	SIF2D 0.2C	
0,08-0,21 mm <sup>2</sup> AWG 28-24	SIF3D 0.2C	
SIM..D ... C (5 A) male stamped crimp contacts (coil package)		500
0,08-0,21 mm <sup>2</sup> AWG 28-24	SIM1D 0.2C	
0,08-0,21 mm <sup>2</sup> AWG 28-24	SIM2D 0.2C	
0,08-0,21 mm <sup>2</sup> AWG 28-24	SIM3D 0.2C	
SIF..D ... R (5 A) female stamped crimp contacts (reel package)		10 000
0,08-0,21 mm <sup>2</sup> AWG 28-24	SIF1D 0.2R	
0,08-0,21 mm <sup>2</sup> AWG 28-24	SIF2D 0.2R	
0,08-0,21 mm <sup>2</sup> AWG 28-24	SIF3D 0.2R	
SIM..D ... R (5 A) male stamped crimp contacts (reel package)		10 000
0,08-0,21 mm <sup>2</sup> AWG 28-24	SIM1D 0.2R	
0,08-0,21 mm <sup>2</sup> AWG 28-24	SIM2D 0.2R	
0,08-0,21 mm <sup>2</sup> AWG 28-24	SIM3D 0.2R	

- cULus (ECBT2.E115072, ECBT8.E115072),

- DNV certified  
- BV pending

**NOTE:**  
The SIF1D/SIM1D and SIF3D/SIM3D crimp contacts are available only upon request.

- contact resistance (all PL) ≤ 10 mΩ

**Recommended crimping tools**

loose parts: **SIPZ W** (see page 142)

coil package: **SIPZC W** (see page 143)

reel package: suitable for stripping / crimping automated machines to be used with 10 000 pieces reels, please contact ILME S.p.A.

The current rating depends on the contact size and on the connector in which they are installed. See derating diagrams of each connector.

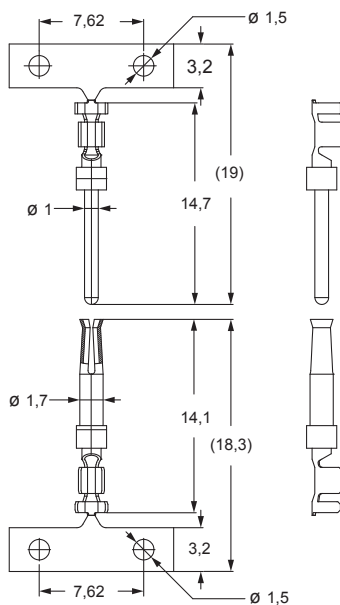

**SIF..D and SIM..D contacts**

conductor section (mm <sup>2</sup> )	conductors stripping length (mm)	max insulation Ø (mm)
0,08-0,21	3	1
0,21-0,52	3	1,5

**SIM..D C**

**Orientation**

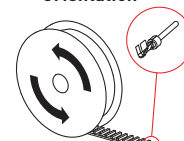

**Reel unrolling left**

**SIM..D R**

**Reel unrolling left**

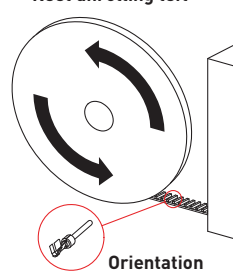

**SIF..D C**

**Orientation**

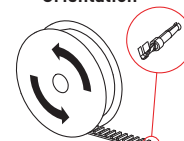

**Reel unrolling left**

**SIF..D R**

**Reel unrolling left**

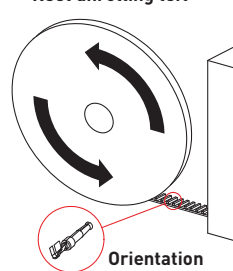

inserts

pages:

CQ 21	21 poles	190
CX 08 B (MIXO BUS)	8 poles + shield	293
CX 25 IB (MIXO)	25 poles	284
CX 36 I (MIXO)	36 poles	30 *
CX 01 9V (MIXO DATA)	9 poles + shield	296
CX 01 9V 2 (MIXO DATA)	9 poles + shield	70 *

SI..D (5 A) crimp contacts

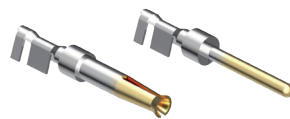

refer to CN.19 pages

\* refer to NEWS 2020 pages

STAMPED CONTACTS

description	part No.	pcs. (1 packaging unit)
SIF..D ... (5 A) female stamped crimp contacts (loose parts)		200
0,21-0,52 mm <sup>2</sup> AWG 24-20	SIF1D 0.5	
0,21-0,52 mm <sup>2</sup> AWG 24-20	SIF2D 0.5	
0,21-0,52 mm <sup>2</sup> AWG 24-20	SIF3D 0.5	
SIM..D ... (5 A) male stamped crimp contacts (loose parts)		200
0,21-0,52 mm <sup>2</sup> AWG 24-20	SIM1D 0.5	
0,21-0,52 mm <sup>2</sup> AWG 24-20	SIM2D 0.5	
0,21-0,52 mm <sup>2</sup> AWG 24-20	SIM3D 0.5	
SIF..D ... C (5 A) female stamped crimp contacts (coil package)		500
0,21-0,52 mm <sup>2</sup> AWG 24-20	SIF1D 0.5C	
0,21-0,52 mm <sup>2</sup> AWG 24-20	SIF2D 0.5C	
0,21-0,52 mm <sup>2</sup> AWG 24-20	SIF3D 0.5C	
SIM..D ... C (5 A) male stamped crimp contacts (coil package)		500
0,21-0,52 mm <sup>2</sup> AWG 24-20	SIM1D 0.5C	
0,21-0,52 mm <sup>2</sup> AWG 24-20	SIM2D 0.5C	
0,21-0,52 mm <sup>2</sup> AWG 24-20	SIM3D 0.5C	
SIF..D ... R (5 A) female stamped crimp contacts (reel package)		10 000
0,21-0,52 mm <sup>2</sup> AWG 24-20	SIF1D 0.5R	
0,21-0,52 mm <sup>2</sup> AWG 24-20	SIF2D 0.5R	
0,21-0,52 mm <sup>2</sup> AWG 24-20	SIF3D 0.5R	
SIM..D ... R (5 A) male stamped crimp contacts (reel package)		10 000
0,21-0,52 mm <sup>2</sup> AWG 24-20	SIM1D 0.5R	
0,21-0,52 mm <sup>2</sup> AWG 24-20	SIM2D 0.5R	
0,21-0,52 mm <sup>2</sup> AWG 24-20	SIM3D 0.5R	

- cULus (ECBT2.E115072, ECBT8.E115072), ccc

- DNV certified

- BV pending

NOTE:

The SIF1D/SIM1D and SIF3D/SIM3D crimp contacts are available only upon request.

- contact resistance (all PL) ≤ 10 mΩ

Recommended crimping tools

loose parts: SIPZ W (see page 142)

coil package: SIPZC W (see page 143)

reel package: suitable for stripping / crimping automated machines to be used with 10 000 pieces reels, please contact ILME S.p.A.

The current rating depends on the contact size and on the connector in which they are installed. See derating diagrams of each connector.

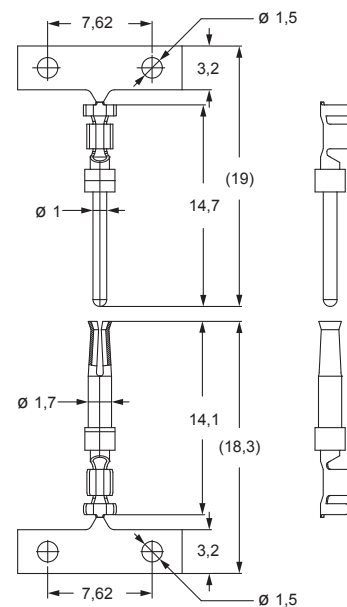

SIF..D and SIM..D contacts

conductor section (mm <sup>2</sup> )	conductors stripping length (mm)	max insulation Ø (mm)
0,08-0,21	3	1
0,21-0,52	3	1,5

SIM..D C

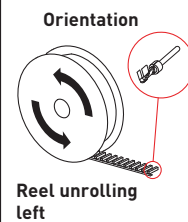

SIM..D R

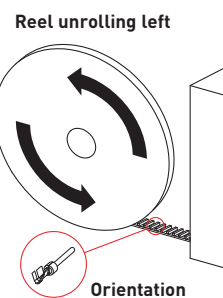

SIF..D C

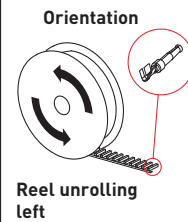

SIF..D R

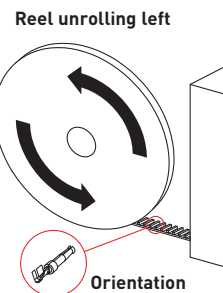

---

## RI SERIES HNM CRIMP CONTACTS (5 A) RIFD /MD

---



Turned crimp contacts designed  
to meet high number of matings (HNM)  
and high durability needs



Find more  
information on  
our products at  
[www.ilme.com](http://www.ilme.com)

# TECHNICAL FEATURES

## RIFD /MD

Especially high thickness gold plated/lubricated contacts series **RI** enable **HNM** feature on suitable MIXO connectors that when mounted on dedicated MIXO HNM frames part nos. **RX 02 /03 /04 /06 TF /TM** also employing especially gold plated PE contacts, allow the creation of HNM MIXO modular inserts, useful when connectors are foreseen for frequent operation, providing up to 10 000 matings compared to the 500 matings provided by series **CI** turned crimp contacts.

Part no.	Conductor sections	
<b>RIFD /MD 0.2</b>	0,08 – 0,21 mm <sup>2</sup>	AWG 28-24
<b>RIFD /MD 0.3</b>	0,13 – 0,33 mm <sup>2</sup>	AWG 26-22
<b>RIFD /MD 0.5</b>	0,33 – 0,52 mm <sup>2</sup>	AWG 22-20
<b>RIFD /MD 0.7</b>	0,52 – 0,75 mm <sup>2</sup>	AWG 20-18

Available in **four sizes**, 0.2 through 0.7, to cover the conductor cross-sectional area range 0,08 mm<sup>2</sup> through 0,75 mm<sup>2</sup> (AWG 28 through AWG 18).

NOTE – The largest size 0.7 contacts are suitable only for CX 25 IBF /IBM inserts.

Stripping length: **4 mm** (same as per series CI)

Series **RI** HNM crimp contacts use the same tools (crimping tools, insertion and removal tools) recommended for series **CI** turned crimp contacts.

Series **RI** HNM crimp contacts provide the same current ratings of series CI turned contacts.

The connector modules of series MIXO that by using HNM 5A contacts series **RI** together with MIXO HNM frames **RX 02...06 TF/TM** can create MIXO HNM modular connector inserts are:

- MIXO **CX 25 IBF /IBM**
- MIXO **CX 36 IF /IM**

Series **RI** HNM crimp contacts must be used in special (new, see page 54) HNM variants of MIXO Gigabit module and (new, see page 38) MIXO Shielded module:

- HNM MIXO Gigabit **RX 08 I6F /I6M**
- HNM MIXO Shielded **RX 20S IF /IM**

NOTE – CQ 21 is not suitable for HNM applications due to lack of HNM hoods and housings size “21.21”. RI contacts are also not suitable for D-Sub 9-pin modules CX 01 9VF /9VM and the new two cable outlet version CX 01 9VF2 /9VM2, not foreseen for HNM applications.

### Environmental conformities:

- RoHS 2: conform with exemption 6(c) (lead in copper alloys)
- China RoHS: conform with exemption – EFUP 50 (years – no marking required)
- REACH SVHC substance: lead

widening of the  
ILME portfolio  
of HNM inserts:  
10, 16, 40 and  
now 5 A

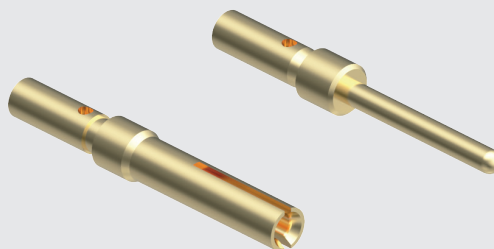

inserts

pages:

<b>CX 25 IB (MIXO)</b>	25 poles	<b>284</b>
<b>CX 36 I (MIXO)</b>	36 poles	<b>30 *</b>
<b>RX 08 D5 (MEGABIT)</b>	8 poles + shield	<b>46 *</b>
<b>RX 08 D5 2 (MEGABIT)</b>	8 poles + shield	<b>46 *</b>

**RI (5 A) crimp contacts gold plated**

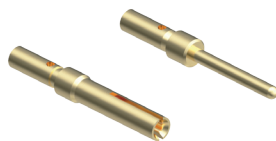

refer to CN.19 pages

\* refer to NEWS 2020 pages

description

part No.

RI (5 A) female crimp contacts  
 0,08-0,21 mm<sup>2</sup> AWG 28-24  
 0,13-0,33 mm<sup>2</sup> AWG 26-22  
 0,33-0,52 mm<sup>2</sup> AWG 22-20  
 0,52-0,75 mm<sup>2</sup> AWG 20-18 \*

**RIFD 0.2**  
**RIFD 0.3**  
**RIFD 0.5**  
**RIFD 0.7**

gold plated

RI (5 A) male crimp contacts  
 0,08-0,21 mm<sup>2</sup> AWG 28-24  
 0,13-0,33 mm<sup>2</sup> AWG 26-22  
 0,33-0,52 mm<sup>2</sup> AWG 22-20  
 0,52-0,75 mm<sup>2</sup> AWG 20-18 \*

**RIMD 0.2**  
**RIMD 0.3**  
**RIMD 0.5**  
**RIMD 0.7**

\* suitable only for CX 25 IBF/IBM

- contact resistance: ≤ 4 mΩ  
 - for crimp contacts RI series use:

**CIPZ D** crimping tool

**CIPZP D** pneumatic crimping tool (see page 144)

**CITP D** turret head

**CIES** insertion / removal tool for contacts 0,2 - 0,5 mm<sup>2</sup>

**CIES B** insertion / removal tool for contacts 0,75 mm<sup>2</sup>

- us (ECBT2.E115072, ECBT8.E115072),

certified

- BV pending

**NOTE:**

The current rating depends on the contact size and on the connector in which they are installed. See derating diagrams of each connector.

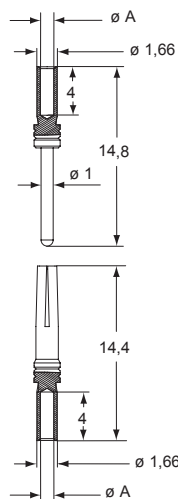

**RIF and RIM contacts**

conductor section (mm <sup>2</sup> )	conductor slot ø A (mm)	conductors stripping length (mm)
0,08-0,21	0,64	4
0,13-0,33	0,90	4
0,33-0,52	1,12	4
0,52-0,75	1,12	4

**RI SERIES HNM CRIMP CONTACTS (5 A) - RIFD /MD**





---

**CX7 SERIES SIZE 6.0**  
**CRIMP CONTACTS (6 mm<sup>2</sup> / 10 AWG)**

---



**70 A crimp contacts**  
**suitable for 6 mm<sup>2</sup> wires**



Find more  
information on  
our products at  
[www.ilme.com](http://www.ilme.com)

## TECHNICAL FEATURES

### CX7FA /MA 6.0

This new size **6.0** adds to the existing sizes **10 – 16 – 25** of series **CX7** removable crimp contacts, to allow lower wire size 6 mm<sup>2</sup> / 10 AWG (stranded copper conductors only), expanding this series to cover conductor cross-sectional area range 6 mm<sup>2</sup> through 25 mm<sup>2</sup> (10 AWG through 4 AWG).

Environmental conformities:

- RoHS 2: conform with exemption 6(c) (lead in copper alloys)
- China RoHS: conform with exemption – EFUP 50 (years – no marking required)
- REACH SVHC substance: lead
- Suitable for use in MIXO module **CX 02 7F /7M**
- Crimping with **CPPZ C** (CEMBRE HT 45) manual crimp tool, crimping dies **CGD 10 C** for CX7 contacts with 6 mm<sup>2</sup> / 10 AWG cross-sectional area, and locator **CX7PZ LOC**. With these tools they provide crimped connections in compliance with EN/IEC 60352-2. Their tensile strength still in conformity with the values of former curve A (closed crimp barrel) of Ed.1.0 of that standard.

increases the  
range of wire  
cross sections  
that can ben used  
in ILME 70A MIXO  
modules

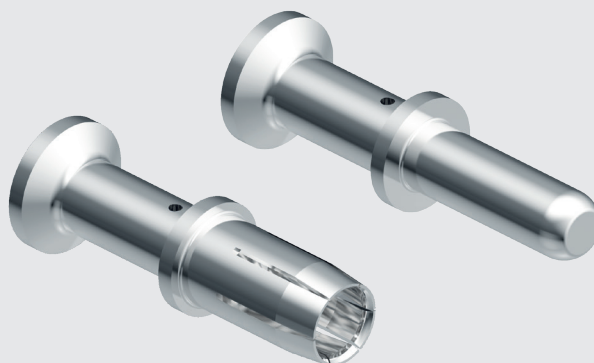

# CX7..6.0 70 A

inserts

page:

70 A silver plated crimp contacts

CX 02 7F /M (MIXO) 2 poles

266

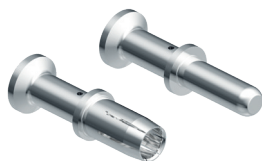

refer to CN.19 pages

description

part No.

70 A female crimp contacts  
6 mm<sup>2</sup> AWG 10

CX7FA 6.0

silver plated

70 A male crimp contacts  
6 mm<sup>2</sup> AWG 10

CX7MA 6.0

- (ECBT2.E115072, ECBT8.E115072),

- certified

- BV pending

- mechanical life: ≥ 500 cycles

- contact resistance: ≤ 0,5 mΩ

- **it is recommended to crimp the contacts with crimping tools homologated by ILME.**

Crimping with CPPZ C (CEMBRE HT 45) manual crimp tool, crimping dies CGD 10 C for CX7 contacts with 6 mm<sup>2</sup> / 10 AWG cross-sectional area, and locator CX7PZ LOC

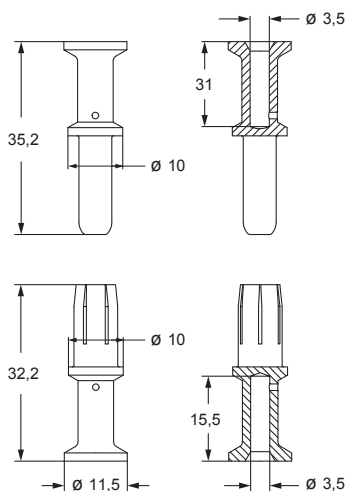

**CX CRIMP CONTACTS 70 A 6 mm<sup>2</sup>**

---

## PCB INTERFACE ADAPTER FOR CQ 12 CIF INSERTS SPECIAL CQ 12 INSERTS FOR PCB ADAPTERS

---



CIF Q12 2.4 (with 12+⊕ gold plated contacts)

Number of contacts: 12 + ⊕

CQF /M 12 CIF (with ⊕ contact with rear Ø 1 mm pin)

EN/IEC 61984 ratings: 7,5 A 250 V 4 kV 3



Find more  
information on  
our products at  
[www.ilme.com](http://www.ilme.com)

## TECHNICAL FEATURES

### CIF Q12 2.4 - CQF 12 CIF /CQM 12 CIF

#### CIF Q12 2.4 (with 12+ Ⓢ gold plated contacts)

NOTE – CIF Q12 2.4A (with 12 + Ⓢ silver plated contacts) available upon request.

#### Special CQ 12 inserts for PCB adapter:

- CQF 12 CIF
- CQM 12 CIF

with PE contact equipped with rear Ø 1 mm pin for mating with the PE contact of the PCB adapter.

#### CIF interface contacts for CQF /M 12 CIF:

- CDFA 6A28 (female contact, silver plated, with rear Ø 1 mm pin for mating with the PCB adapter)
- CDMA 6A (male contact, silver plated, with rear Ø 1 mm pin for mating with the PCB adapter)

NOTE – Gold plated variants of the interface contacts CDFD 6A28 and CDMD 6A available upon request.

The new PCB adapter **CIF Q12 2.4** (gold plated contacts, available on request **CIF Q12 2.4** with silver plated contacts) allows cable-to-PCB connection with CQ 12 – 12P+ Ⓢ industrial heavy-duty connector inserts for power electronics and/or signal applications, to reduce wiring costs (where “large numbers” justify the development of a PCB design).

Due to the contact pitch and the layout pattern on the PCB, a reduction of rated voltage for CQ 12 is required from 400/690V to 250V.

The **CIF Q12 2.4** PCB interface adapter is suitable for printed circuit board application by soldering to PCBs with thickness up to 2,4 mm.

The special variants of **CQ 12** inserts that mate on this adapter:

- CQF 12 CIF
- CQM 12 CIF

feature the PE contact with Ø 1 mm pin instead of the usual screw terminal, for mating with the PCB adapter. This PE contact provides protective earth connection to a metal housing. These inserts are therefore suitable for any kind of bulkhead mounting “21.21” enclosure (insulating, metal).

In such special inserts it is necessary to use special interface contacts:

- for female CQF 12 CIF: **CDFA 6A28** female, silver plated, with rear Ø 1 mm pin for mating with **CIF Q12 2.4** PCB interface adapter;
- for male CQM 12 CIF: **CDMA 6A** male, silver plated, with rear Ø 1 mm pin for mating with **CIF Q12 2.4** PCB interface adapter.

The above special contacts are available on request with standard gold plating as **CDFD 6A28** and **CDMD 6A**.

Each of the above special inserts, to be mated respectively by a corresponding standard insert of opposite gender (**CQM 12** or **CQF 12**, see Assembly Instructions on page 91), can be equipped, together with their mating counterpart, with 2 **coding pins CR Q12**, allowing up to 16 different codings (see page 689 of CN.19 catalogue), to avoid unintended mating in case of multiple of these connectors installed nearby on the same PCB.

Connectorization allows minimisation of downtime in factory automation due to easy replacement of modular PCB circuitry (easier and faster maintenance).

NOTE: In cable-to-PCB connection applications, safety does not depend only on the designs of the adapter and of the corresponding connector, it depends also on the design of the PCB and of the equipment – e.g. its enclosure and relevant spacings if metallic – where the PCB circuit and the cable to board are employed; hence, no **CE** marking (nor the conceptually equivalent Eurasian Conformity mark EAC) can be applied on the PCB adapters, even if by rated voltage they fall under the scope of the Low Voltage Directive 2014/35/EU.

#### Technical characteristics

Number of contacts: 12 + Ⓢ

EN/IEC 61984 ratings: **7,5 A 250 V 4 kV 3**

Lower and Upper Limiting Temperatures (LLT, ULT):  
-40 °C ... +125 °C

NOTE – The adapter insulating material is able to withstand wave soldering of the PCB.

# CIF Q12 2.4 PCB interface adapters for CQ 12 CIF inserts 7,5 A 250 V

inserts page: 90  
**CQ CIF** 12 poles + ⊕ **PCB interface adapter for CQ 12 inserts, special CQ 12 inserts for PCB adapter**  
**7,5 A interface contacts for special CQ 12 inserts, silver plated**

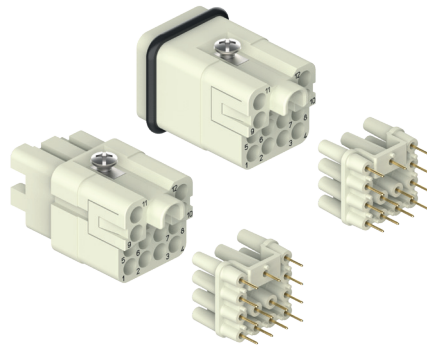

description	part No.	part No.
-------------	----------	----------

PCB interface adapter with contacts for up to 2,4 mm thick PCB	<b>CIF Q12 2.4</b>	
female special insert for female interface contacts	<b>CQF 12 CIF</b>	
male special insert for male interface contacts	<b>CQM 12 CIF</b>	
7,5 A female interface contacts for female special insert		<b>CDFA 6A28</b>
7,5 A male interface contacts for male special insert		<b>CDMA 6A</b> <span style="background-color: #cccccc; padding: 2px;">silver plated</span>

- characteristics according to EN/IEC 61984 ratings: **7,5 A 250 V 4 kV 3**
- us (ECBT2.E115072, ECBT8.E115072)
- certified
- BV pending, EAC (CIF Q12 2.4) pending
- Lower and Upper Limiting Temperatures (LLT, ULT): -40 °C ... +125 °C
- The adapter insulating material is able to withstand wave soldering of the PCB.
- number of contacts: 12 + ⊕

**NOTE: CQ 12 inserts are already fit with the special PE interface contact. To fully populate the inserts, twelve interface contacts, respectively male or female, are required.**

The adapter is soldered on the printed circuit on which the multipole connector (female or male) equipped with interface contacts will then be inserted.

### CIF Q12 2.4

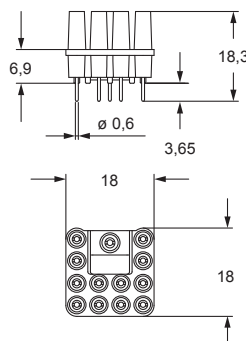

### PCB-Layout

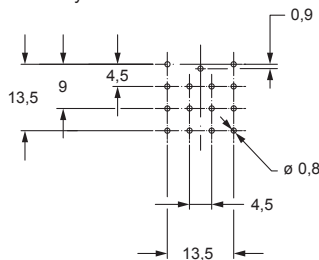

### CQ CIF

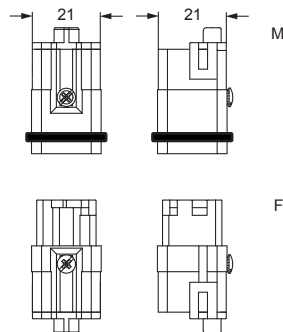

contacts side (front view)

side with reference arrow ▲

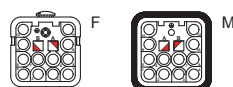

### CDMA 6A

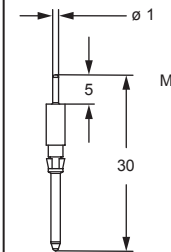

### CDFA 6A28

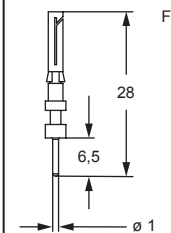

The **CR Q12** coding pins (**to be ordered separately**), allow the user to create 16 different combinations, according to the diagram shown on **page 689 of CN.19 catalogue**.





# ASSEMBLY INSTRUCTIONS

## CIF Q12 2.4 - PCB INTERFACE ADAPTERS FOR CQ 12 INSERTS

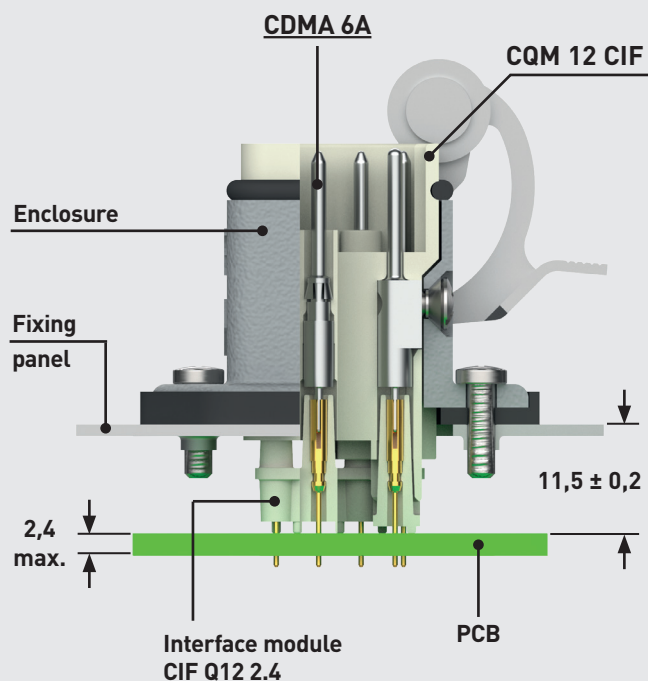
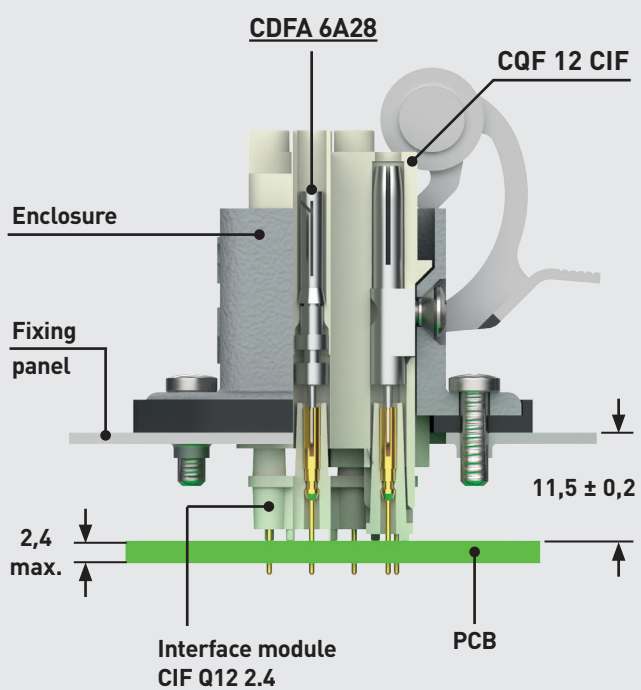
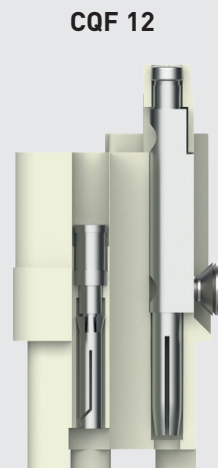
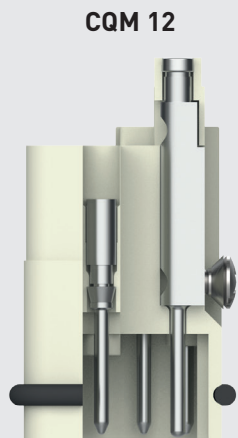

---

## PCB INTERFACE ADAPTER FOR CQ 07 INSERTS

### CIF Q07 2.4

---

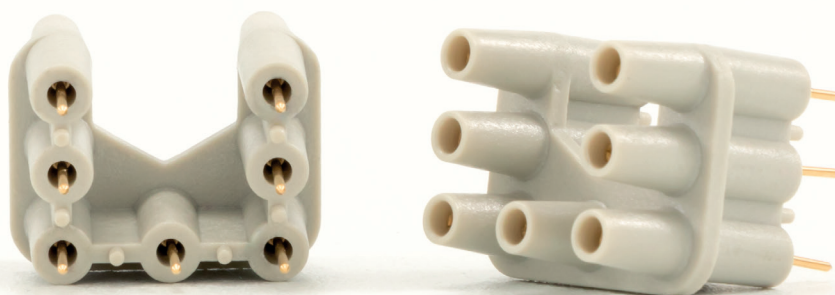

CIF Q07 2.4

(with gold plated contacts)

Number of contacts: 7

EN/IEC 61984 ratings: 7,5 A 250 V 4 kV 3



Find more  
information on  
our products at  
[www.ilme.com](http://www.ilme.com)

# TECHNICAL FEATURES

## CIF Q07 2.4

### CIF Q07 2.4 (with gold plated contacts)

NOTE – CIF Q07 2.4A (with silver plated contacts) available upon request

#### CIF interface contacts:

- **CDFA 6A28** (female contact, silver plated, with rear Ø 1 mm pin for mating with the PCB adapter)
- **CDMA 6A** (male contact, silver plated, with rear Ø 1 mm pin for mating with the PCB adapter)

NOTE – Gold plated variants of the interface contacts CDFD 6A28 and CDMD 6A available upon request.

This new **CIF Q07 2.4** adapter (with gold plated contacts, available upon request with silver plated contacts **CIF Q07 2.4A**) allows cable-to-PCB connection with CQ 07 7P+⊕ industrial heavy-duty connector inserts for power electronics and/or signal applications, to reduce wiring costs (where “large numbers” justify the development of a PCB design).

The **CIF Q07 2.4** PCB interface adapter is suitable for printed circuit board application by soldering to PCBs with thickness up to 2,4 mm.

Due to the contact pitch and the layout pattern on the PCB, a reduction of rated voltage for CQ 07 is required from 400V to 250V.

For the connection to the PCB adapter of **CQ 07** inserts it is necessary to equip these standard inserts with **special interface contacts** (except the PE contact, embedded in the insert, and screw-type):

- for female **CQF 07**: **CDFA 6A28** female, silver plated, with rear Ø 1 mm pin for mating with **CIF Q07 2.4** PCB interface adapter;
- for male **CQM 07**: **CDMA 6A** male, silver plated, with rear Ø 1 mm pin for mating with **CIF Q07 2.4** PCB interface adapter.

Connectorization allows minimisation of downtime in factory automation due to easy replacement of modular PCB circuitry (easier and faster maintenance).

NOTE: In cable-to-PCB connection applications, safety does not depend only on the designs of the adapter and of the corresponding connector, it depends also on the design of the PCB and of the equipment – e.g. its enclosure and relevant spacings if metallic – where the PCB circuit and the cable to board are employed; hence, no **CE** marking (nor the conceptually equivalent Eurasian Conformity mark EAC) can be applied on the PCB adapters, even if by rated voltage they fall under the scope of the Low Voltage Directive 2014/35/EU.

### Technical characteristics

Number of contacts: 7

EN/IEC 61984 ratings: **7,5 A 250 V 4 kV 3**

Lower and Upper Limiting Temperatures (LLT, ULT):  
-40 °C ... +125 °C

NOTE – The adapter insulating material is able to withstand wave soldering of the PCB.

**CAUTION** – The layout of the PCB for this adapter must foresee a suitable pass-through hole for the PE wiring coming from the screw-type PE terminal of CQF /M 07 connector. This adapter does not foresee a PE connection. It is important to fulfil the continuity of PE connection of the CQF /M 07 connector, also for the possibility to use a metal housing.

# CIF Q07 2.4 PCB interface adapters for CQ 07 inserts 7,5 A 250 V

inserts page: 187  
**CQ** 7 poles + ⊕

PCB interface adapter for CQ 07 inserts

7,5 A interface contacts for CQ 07 inserts, silver plated

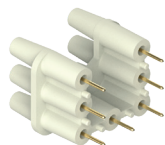

refer to CN.19 pages

description	part No.	part No.
-------------	----------	----------

PCB interface adapter with contacts for up to 2,4 mm thick PCB

**CIF Q07 2.4**

7,5 A female interface contacts for female insert  
 7,5 A male interface contacts for male insert

**CDFA 6A28**  
**CDMA 6A** silver plated

- characteristics according to EN/IEC 61984 ratings:  
**7,5 A 250 V 4 kV 3**
- (ECBT2.E115072, ECBT8.E115072)
- certified
- BV pending, EAC (CIF Q07 2.4) pending
- Lower and Upper Limiting Temperatures (LLT, ULT):  
 -40 °C ... +125 °C
- The adapter insulating material is able to withstand wave soldering of the PCB.
- number of contacts: 7

The adapter is soldered on the printed circuit on which the multipole connector (female or male) equipped with interface contacts will then be inserted.

**CIF Q07 2.4**

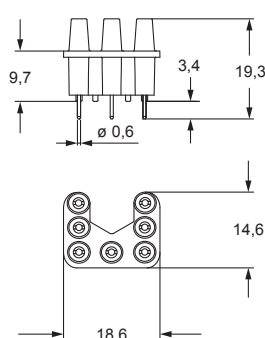

PCB-Layout

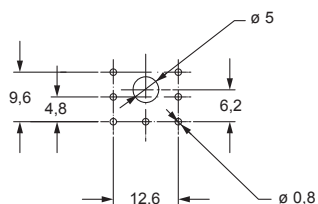

**CDMA 6A**

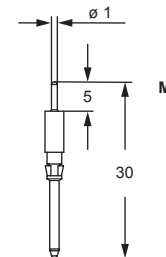

**CDFA 6A28**

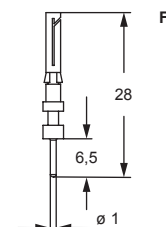

# ASSEMBLY INSTRUCTIONS

## CIF Q07 2.4 - PCB INTERFACE ADAPTERS FOR CQ 07 INSERTS

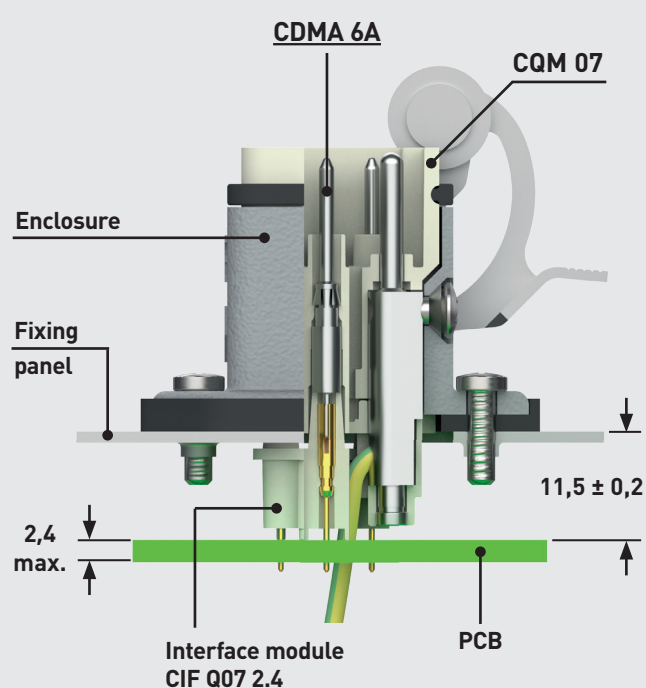
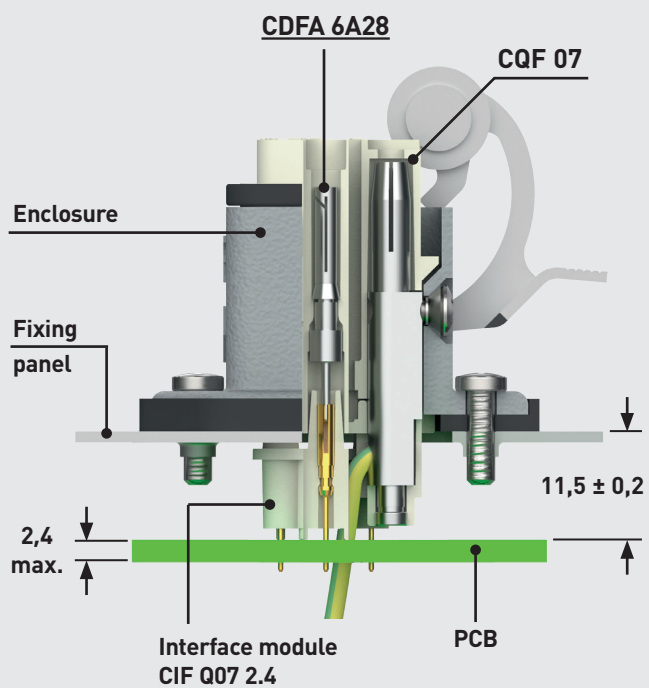
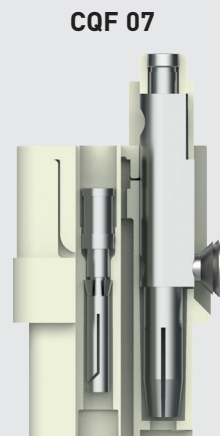
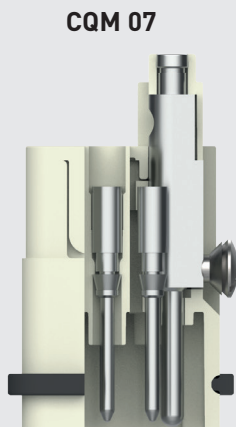

---

## PCB INTERFACE ADAPTER FOR CQ 05 INSERTS

### CIF Q05 2.4

---

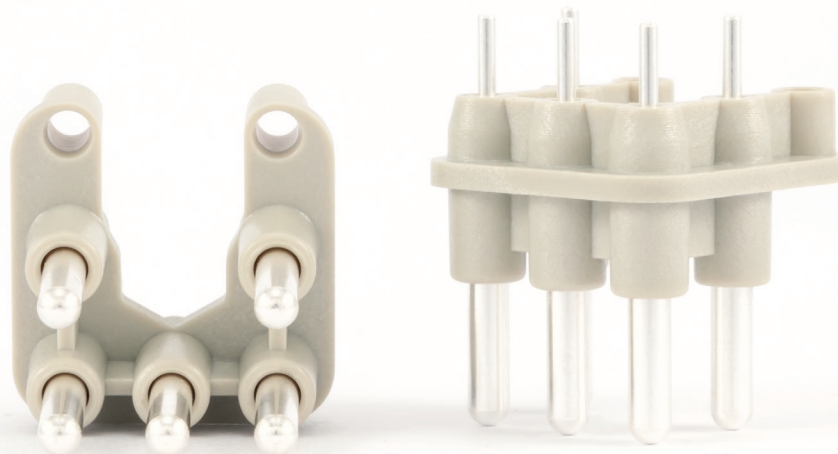

CIF Q05 2.4  
(with silver plated contacts)

Number of contacts: 5

EN/IEC 61984 ratings: 10 A 250 V 4 kV 3



Find more  
information on  
our products at  
[www.ilme.com](http://www.ilme.com)

# TECHNICAL FEATURES

## CIF Q05 2.4

### CIF Q05 2.4 (with silver plated contacts)

NOTE – CIF Q05 2.4D (with gold plated contacts) available upon request

#### CIF interface contacts:

- **CCFFA** (female/female contact)
- **CCMFA** (male/female contact)

NOTE – CCFFD and CCMFD interface contacts available with standard gold plating upon request.

This new **CIF Q05 2.4** PCB adapter (silver plated contacts, available upon request with standard gold plated contacts **CIF Q05 2.4D**) allows cable to printed circuit board connection with CQ 05 5P+⊕ industrial heavy-duty connector inserts for power electronics and/or signal applications, to reduce wiring costs (where “large numbers” justify the development of a PCB design).

The **CIF Q05 2.4** PCB interface adapter is suitable for printed circuit board application by soldering to PCBs with thickness up to 2,4 mm.

For the connection to the PCB adapter of CQ 05 inserts it is necessary to equip these inserts with **special interface contacts** (except the PE contact, embedded in the insert, and screw-type):

- for female CQF 05: **CCFFA** female, silver plated, with rear □ 1 mm post for soldering on the PCB passing through the CIF Q05 2.4 PCB interface adapter;
- for male CQM 05: **CCMFA** male, silver plated, with rear □ 1 mm post for soldering on the PCB passing through the CIF Q05 2.4 PCB interface adapter.

Connectorization allows minimisation of downtime in factory automation due to easy replacement of modular PCB circuitry (easier and faster maintenance).

NOTE: In cable-to-PCB connection applications, safety does not depend only on the designs of the adapter and of the corresponding connector, it depends also on the design of the PCB and of the equipment – e.g. its enclosure and relevant spacings if metallic – where the PCB circuit and the cable to board are employed; hence, no **CE** marking (nor the conceptually equivalent Eurasian Conformity mark EAC) can be applied on the PCB adapters, even if by rated voltage they fall under the scope of the Low Voltage Directive 2014/35/EU.

### Technical characteristics

Number of contacts: 5

EN/IEC 61984 ratings: **10 A 250 V 4 kV 3**

Lower and Upper Limiting Temperatures (LLT, ULT):  
-40 °C ... +125 °C

NOTE – The adapter insulating material is able to withstand wave soldering of the PCB.

**CAUTION** – The layout of the PCB for this adapter must foresee a suitable pass-through hole for the PE wiring coming from the screw-type PE terminal of CQF /M 05 connector. This adapter does not foresee a PE connection. It is important to fulfil the continuity of PE connection of the CQF /M 05 connector, also for the possibility to use a metal housing that must be connected to the PE circuit.



# CIF Q05 2.4 PCB interface adapter for CQ 05 inserts 10 A 250 V

inserts page: 186  
**CQ** 5 poles + ⊕

**PCB interface adapter for CQ 05 inserts**

**16 A interface contacts for CQ 05 inserts, silver plated**

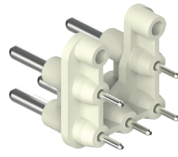

refer to CN.19 pages

description	part No.	part No.
-------------	----------	----------

PCB interface adapter with silver plated contacts for up to 2,4 mm thick PCB

**CIF Q05 2.4**

16 A female interface contacts for female insert  
 16 A male interface contacts for male insert

**CCFFA  
CCMFA**

silver plated

- characteristics according to EN/IEC 61984 ratings:  
**10 A 250 V 4 kV 3**
- (ECBT2.E115072, ECBT8.E115072)
- certified
- BV pending, EAC (CIF Q05 2.4) pending
- Lower and Upper Limiting Temperatures (LLT, ULT):  
 -40 °C ... +125 °C
- The adapter insulating material is able to withstand wave soldering of the PCB.
- number of contacts: 5

**CIF Q05 2.4**

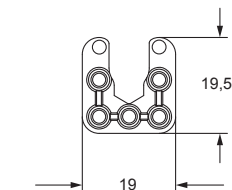
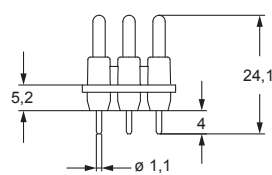

PCB-Layout

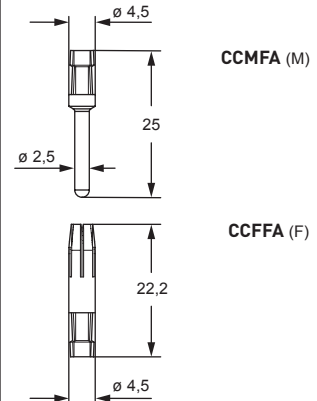
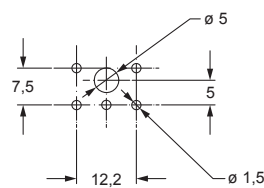

The adapter is soldered on the printed circuit on which the multipole connector (female or male) equipped with interface contacts will then be inserted.

# ASSEMBLY INSTRUCTIONS

## CIF Q05 2.4 - PCB INTERFACE ADAPTERS FOR CQ 05 INSERTS

**CQM 05**

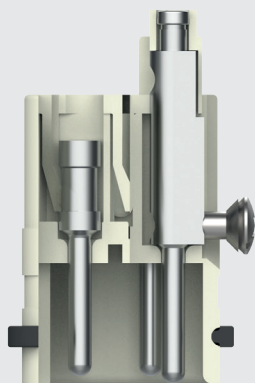

**CQF 05**

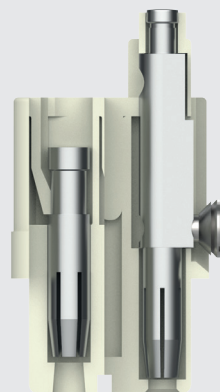

**CCFFA**

**CQF 05**

Enclosure

Fixing panel

2,4  
max.

Interface module  
CIF Q05 2.4

PCB

10,8 ± 0,2

**CCMFA**

**CQM 05**

Enclosure

Fixing panel

2,4  
max.

Interface module  
CIF Q05 2.4

PCB

10,8 ± 0,2

---

## PARALLEL BRIDGES CR BDSH FOR CDSH-SQUICH® CONNECTOR INSERTS

---

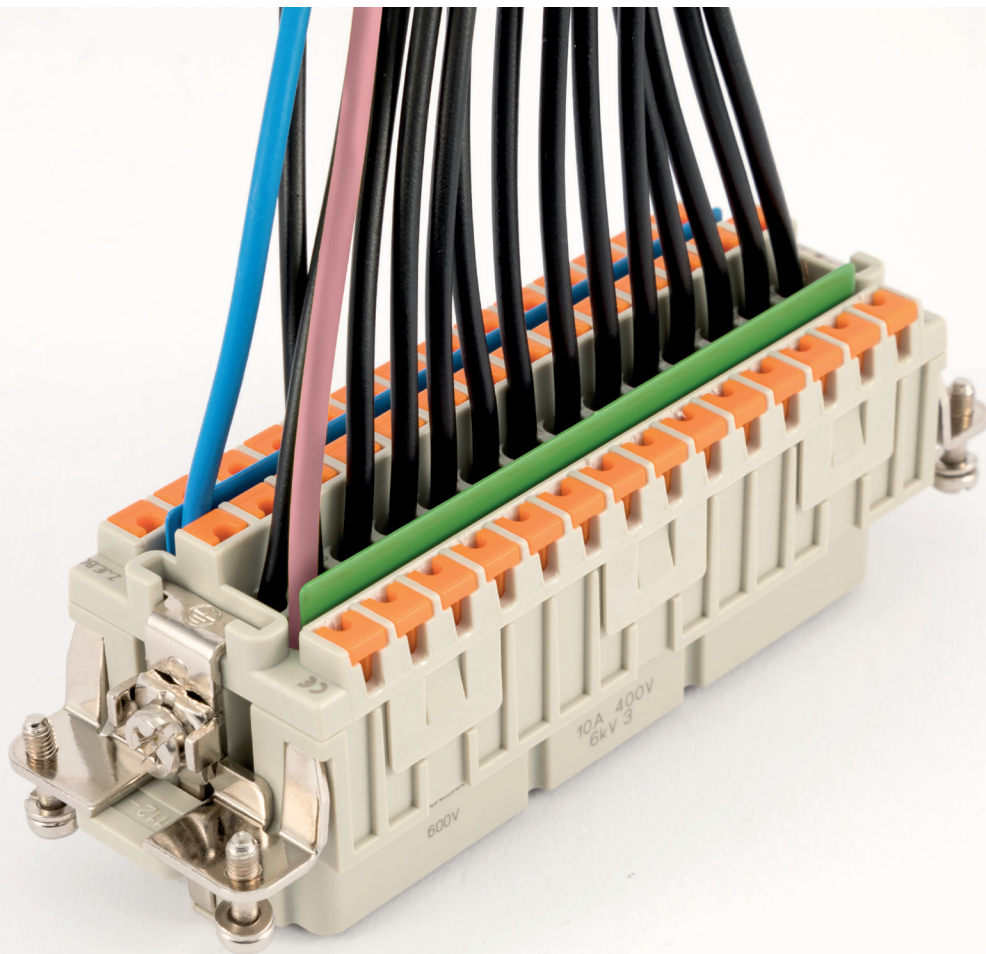

Parallel bridges  
for CDSH SQUICH® 3-, 6-, 9-, 14- pin  
2 colours available: light blue and green  
EN/IEC 61984 ratings: 10 A 50 V 0,8 kV 3



Find more  
information on  
our products at  
[www.ilme.com](http://www.ilme.com)

# TECHNICAL FEATURES

## CR BDSH

**CR BDSH** parallel bridges are made available in order to quickly and economically put electrically in parallel multiple circuits on the same connector.

This quick connection solution reduces the number of connections inside a control panel to feed multiple sensors/actuators.

Suitable for series **CDSH-SQUICH®** connector inserts, that due to their **original and proprietary design** with a 3-row pattern configuration, allow to assign each “slice” of connector to an actuator/sensor that typically requires a 3-lead wiring.

Use of parallel bridges for the “common” references (e.g.: the neutral return and the +24 V feed or the common earth (ground) reference) dramatically cuts the need for individual wiring of each sensor/actuator: only one wire is needed for these common functions, all the others are shunted together by **CR BDSH** parallel bridges.

2 colours available: **light blue** and **green**.

Series **CDSH** (SQUICH® 10 A) representing the compact evolution of the SQUICH® technology comes particularly at hand for field wiring of multiple sensors. These elements require usually a 3-lead wiring and CDSH connectors are the only connectors on the market able to offer 3 SQUICH® fast wiring terminals in-line: CDSH 09 covers the wiring of 3 sensors, CDSH 18 allows 6 sensors to be wired, CDSH 27 allows 9 sensors to be wired and CDSH 42 allows up to 14 sensors to be wired.

A full wiring would require 3 wires per each sensor, but all sensors have two circuits that share the potential. If it would be possible to put in parallel on the connector such circuits, a lot of wiring time and a lot of wire could be spared.

By employing the new **CR BDSH** parallel bridges, available in 4 sizes (3-pin, 6-pin, 9-pin and 14-pin) and in two colours – **light blue** and **green**, identified in their part nos. respectively by suffix **A** (azure, i.e. light blue) or **G** (green) – it is now possible to feed just one circuit in a line of 3, 6, 9, or 14 (depending on the connector chosen) and all the other circuits i.e. sensors will be simultaneously provided with the same potential.

Usually the required potential for such sensors are a 0 V reference (earth/ground potential) and a feeding voltage e.g. 24 V. The third wire is deemed to carry the feedback signal from the field. Use of a **CDSH** connector in synergy with a couple of **CR BDSH** parallel bridges, one for the FE circuit, the other for the common return for potential (neutral) allows sparing a lot of wiring time and a large quantity of wire.

Due to the inherently low voltage of these applications (both neutral and FE are at 0 V potential) there is no need to provide such **CR BDSH** bridges with additional costly insulation: they are provided with an insulating enamel coating, which is able to provide a **10 A 50 V 0,8 kV 3 rating**.

Connector insert series CDSH <sup>(1)</sup>	Parallel bridge – <b>light blue</b> colour	Parallel bridge – <b>green</b> colour
CDSH 09, CDSH 18, CDSH 27, CDSH 42	CR BDSH3A	CR BDSH3G
	CR BDSH6A	CR BDSH6G
	CR BDSH9A	CR BDSH9G
	CR BDSH14A	CR BDSH14G

<sup>(1)</sup> Parallel bridges fit only on inserts of series CDSH of larger or equal number of “columns”: 3-pin bridges fit on all inserts, 6-pin bridges fit on all but CDSH 09, 9-pin bridges fit on CDSH 27 and CDSH 42, 14-pin bridges fit only on CDSH 42.

**CAUTION – CR BDSH** parallel bridges shall be used only with unprepared conductors up to 1,5 mm<sup>2</sup> / 16 AWG.

The rated current applies to the conductor used to feed the **CR BDSH** parallel bridge, it applies to the above indicated maximum wire size and is distributed to all pins in parallel in a manner inversely proportional to the impedance of the served branch circuit. When all branches are with identical impedance, the current is equally divided by the number of served branches in parallel.

EN/IEC 61984 ratings: **10 A 50 V 0,8 kV 3**

Lower and Upper Limiting Temperatures (LLT, ULT):  
-40 °C + 125 °C

NOTE – These CR BDSH parallel bridges are accessories for the CDSH connector inserts only and are not electrical components able to provide a definite electrical function by themselves, for this reason even if they would have a voltage rating within the scope of the Low Voltage Directive 2014/35/EU (which they do not) they would not bear the **CE** marking, nor be subject to the similar EAC TR CU 004/2011 regulation. Moreover, their voltage rating is in the extra-low voltage range, i.e. inherently safe provided they are used within such ratings and out of scope of the above regulations. So, for two reasons neither the **CE** marking nor the EAC mark are applicable.

# CR BDSH A parallel bridges for CDSH-SQUICH® 10 A 50 V

**inserts**

CDSH-SQUICH®	9 poles + ⊕	<b>86</b>
CDSH-SQUICH®	18 poles + ⊕	<b>87</b>
CDSH-SQUICH®	27 poles + ⊕	<b>88</b>
CDSH-SQUICH®	42 poles + ⊕	<b>89</b>

pages:

**parallel bridges**

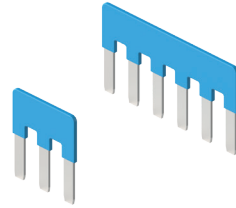

**parallel bridges**

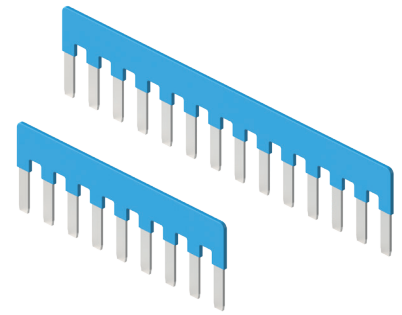

refer to CN.19 pages

description	part No.	part No.
-------------	----------	----------

parallel bridge, 3-pin light blue colour  
 parallel bridge, 6-pin light blue colour  
 parallel bridge, 9-pin light blue colour  
 parallel bridge, 14-pin light blue colour

**CR BDSH3A**  
**CR BDSH6A**

**CR BDSH9A**  
**CR BDSH14A**

- characteristics according to EN/IEC 61984 ratings:  
**10 A 50 V 0,8 kV 3**  
 - Lower and Upper Limiting Temperatures (LLT, ULT):  
 -40 °C ... +125 °C

**CAUTION** – CR BDSH parallel bridges shall be used only with unprepared conductors up to 1,5 mm<sup>2</sup> / 16 AWG.

The rated current applies to the conductor used to feed the CR BDSH parallel bridge, it applies to the above indicated maximum wire size and is distributed to all pins in parallel in a manner inversely proportional to the impedance of the served branch circuit. When all branches are with identical impedance, the current is equally divided by the number of served branches in parallel.

**CR BDSH3A**

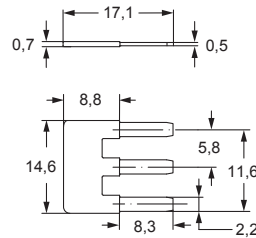

**CR BDSH9A**

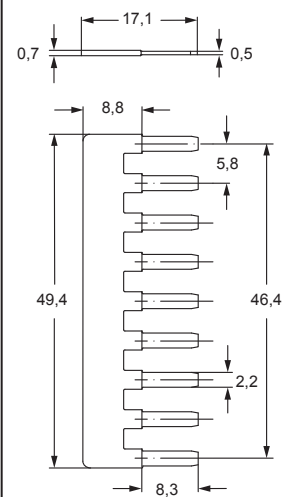

**CR BDSH6A**

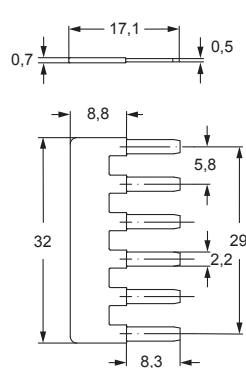

**CR BDSH14A**

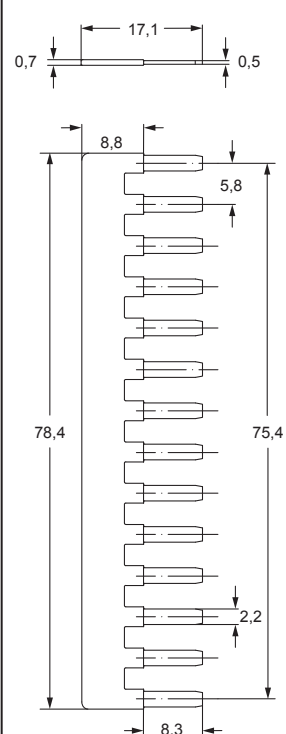

# CR BDSH G parallel bridges for CDSH-SQUICH® 10 A 50 V

**inserts**

CDSH-SQUICH®	9 poles + ⊕	<b>86</b>
CDSH-SQUICH®	18 poles + ⊕	<b>87</b>
CDSH-SQUICH®	27 poles + ⊕	<b>88</b>
CDSH-SQUICH®	42 poles + ⊕	<b>89</b>

pages:

**parallel bridges**

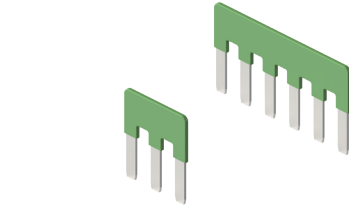

**parallel bridges**

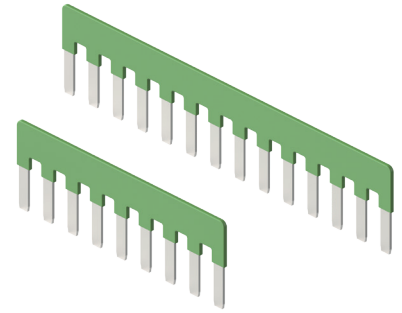

refer to CN.19 pages

description	part No.	part No.
-------------	----------	----------

parallel bridge, 3-pin green colour  
 parallel bridge, 6-pin green colour  
 parallel bridge, 9-pin green colour  
 parallel bridge, 14-pin green colour

**CR BDSH3G**  
**CR BDSH6G**

**CR BDSH9G**  
**CR BDSH14G**

- characteristics according to EN/IEC 61984 ratings:  
**10 A 50 V 0,8 kV 3**  
 - Lower and Upper Limiting Temperatures (LLT, ULT):  
 -40 °C ... +125 °C

**CAUTION** – CR BDSH parallel bridges shall be used only with unprepared conductors up to 1,5 mm<sup>2</sup> / 16 AWG.

The rated current applies to the conductor used to feed the CR BDSH parallel bridge, it applies to the above indicated maximum wire size and is distributed to all pins in parallel in a manner inversely proportional to the impedance of the served branch circuit. When all branches are with identical impedance, the current is equally divided by the number of served branches in parallel.

**CR BDSH3G**

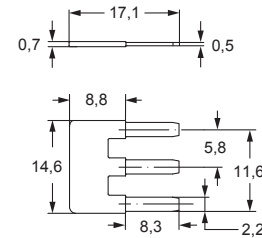

**CR BDSH9G**

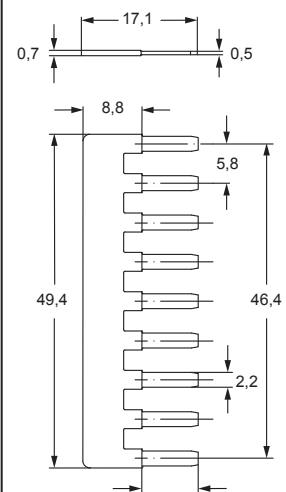

**CR BDSH6G**

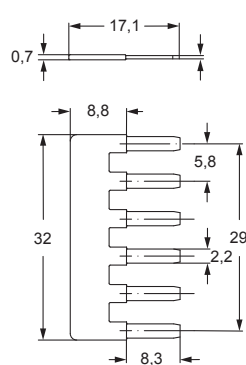

**CR BDSH14G**

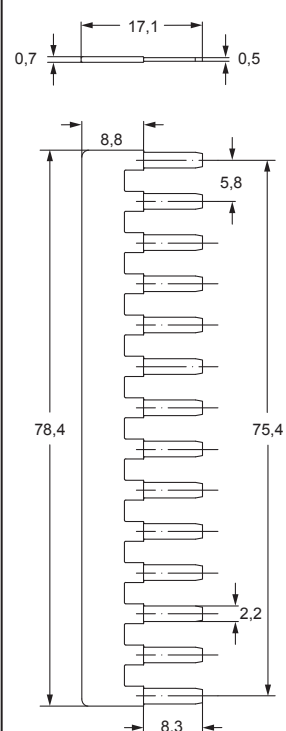

WIRING INSTRUCTIONS



Watch  
our online  
tutorial

PARALLEL BRIDGES CR BDSH FOR CDSH CONNECTOR INSERTS

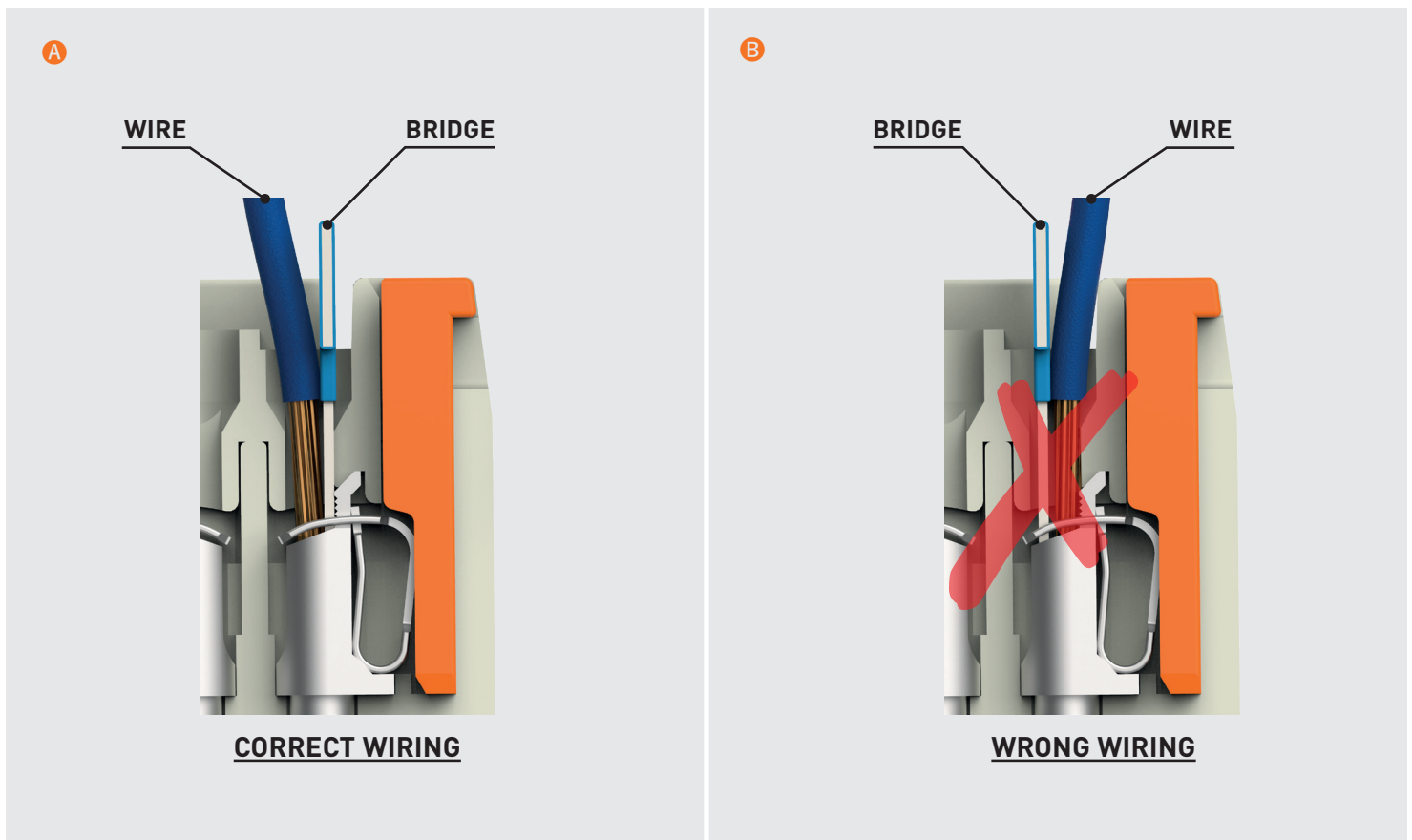

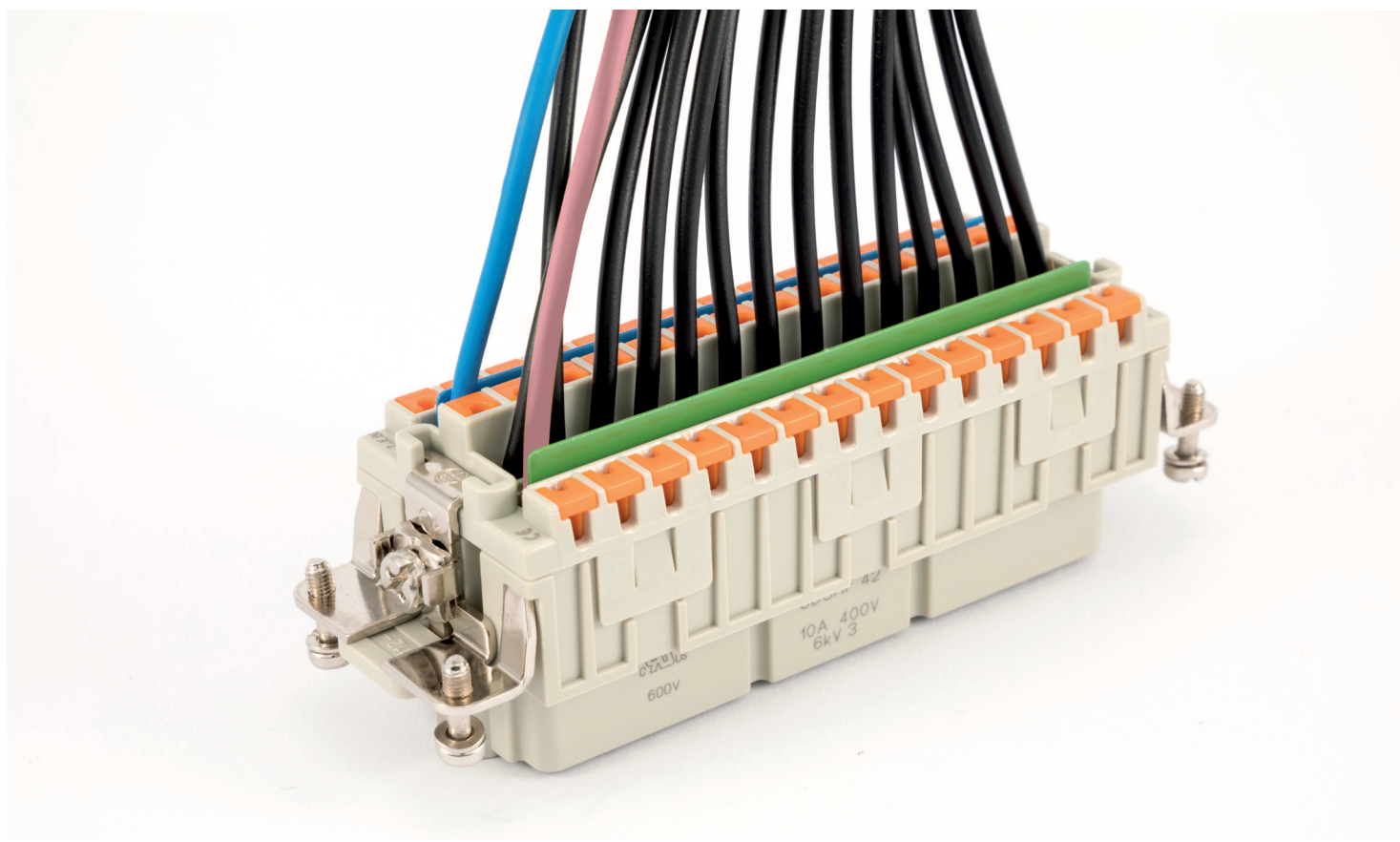

**CR BDSH PARALLEL BRIDGES FOR CDSH CONNECTOR INSERTS**

---

## CKH - MKH HYGIENIC ENCLOSURES SIZE "21.21"

---

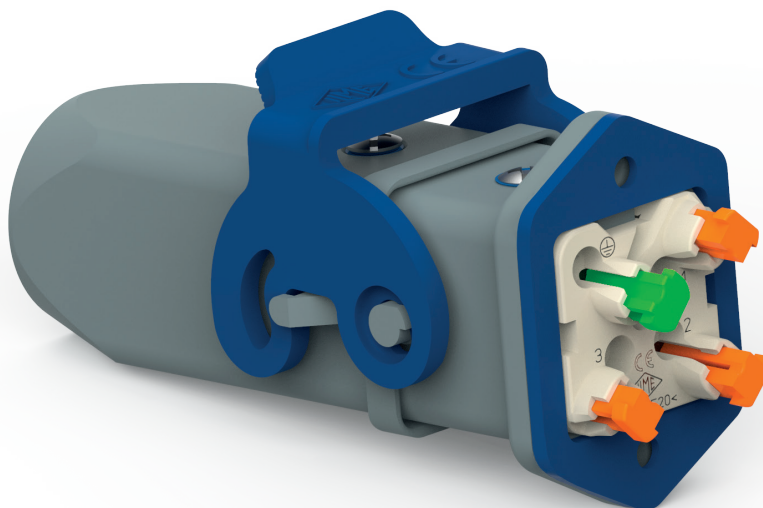

Made by thermoplastic insulating materials suitable for splash area, qualified for resistance to cleaning agents by ECOLAB and in compliance with EHEDG Guideline no. 32



Find more information on our products at [www.ilme.com](http://www.ilme.com)

# TECHNICAL FEATURES

## CKH - MKH HYGIENIC ENCLOSURES

The new series **CKH – MKH HYGIENIC** size “21.21” enclosures, completes the offer of HYGIENIC connector enclosures of series T-TYPE HYGIENIC, by adding enclosures for the growing family of size “21.21” connector inserts, currently comprising the models listed in **Table 1** (power, signal and data connectors, including fibre optics).

The sealing gasket of those male inserts that include it (see **Table 1**, items marked with ●) has to be replaced with the special HYGIENIC sealing gasket **CR 21.21 GMH**, blue coloured, for easier detection in case of loss in the food path.

The **CR 21.21 GMH** gasket is included in each hood package, where specified in **Table 2**.

**Table 1 – “21.21” connector inserts suitable for CKH-MKH HYGIENIC enclosures**

CKF /M 03 /04 ●
CKSHF /M 03 /04 ●
CDF /M 07 ●
CDF /M 08 ●
CQF /M 05 ●
CQF /M 07 ●
CQF /M 12 ●
CQF /M 21 ●
CQ4F /M 03 ●
CQ4F /M 02 ●
CQ4F /M 02 H ●
CQ4F /M 03/2 ●
CX 1/2 BDF /M ○
CXL SF /SM, CXL 2/4 SF /SM, CXL 2/4 PF /PM, CXL 2/4 PFH /PMH, CXL PF /PM ○
CLK 04 SCF /SCF-H /SCM ○
CUK 2FT, CUK 3FT ○
CJ KF /KM ○
CKJ 8M ○
CJK 8FT /8MT ○
CJK 8IFT, CJK 8BIFT, CJK 8PIFT, CJK 8 IMT ○
● The male insert of these models are provided with a standard sealing gasket. For HYGIENIC applications with CKH – MKH HYGIENIC enclosures this gasket must be replaced with the special HYGIENIC gasket <b>CR 21.21 GMH</b> .
○ The male inserts of these models are not provided with that sealing gasket on the male insert, hence for hygienic applications they are deemed to be used only in hygienic enclosures with glued hygienic gasket (identified by letter G in the first portion of their part No.).

The available models of CKH – MKH HYGIENIC enclosures are described in the following **Table 2**.

All of them are provided with both kits **CKRH 65** and **CKRH 65 D** (for CD 07 and CD 08 inserts), screw with food grade gasket (blue coloured). The kit corresponding to the insert (**CKRH 65** for all but CD 07 and CD 08 inserts, **CKRH 65 D** for CD 07 and CD 08 inserts) must replace either the standard screw or the screw with gasket provided with the insert.

**Table 2 – CKH – MKH Hygienic enclosures size “21.21”**

Part no.	Description
CKH 03 I	bulkhead mounting housing
CKH 03 IA	angled bulkhead mounting housing
MKH IAP20	angled bulkhead mounting housing with M20 cable entry
MKH V20	hood with pegs, top entry M20 <b>with CR 21.21 GMH HYGIENIC gasket included</b>
MKH V25	hood with pegs, top entry M25 <b>with CR 21.21 GMH HYGIENIC gasket included</b>
MKH VA20	hood with pegs, side entry M20 <b>with CR 21.21 GMH HYGIENIC gasket included</b>
MKH VG20	hood with lever, top entry M20
MKH VG25	hood with lever, top entry M25
CKH 03 C	cover with pegs and gasket, for female inserts (eyelet cord)
CKH 03 CS	cover with pegs and gasket, for female inserts (loop cord)
CKH 03 CA	cover with pegs, for male inserts (eyelet cord)
CKH 03 CAS	cover with pegs, for male inserts (loop cord)
CKH 03 CX	cover with lever and gasket, for female inserts (eyelet cord)
CKH 03 CXA	cover with lever, for male inserts (loop cord)
MKGH V20	hood with pegs and glued gasket, top entry M20
MKGH V25	hood with pegs and glued gasket, top entry M25
MKGH VA20	hood with pegs and glued gasket, angled entry M20

This new series offers three **bulkhead mounting housings** (the straight model and two angled models, one closed, the other with M20 side cable entry), five **hoods** differing by the size of cable entry (M20, M25) and either presence or absence of locking pegs or lever, e.g. for cable-to-cable joints, and the same **models with glued gasket** (letter G in the first portion of their part no.), for those inserts that by design do not include the sealing gasket on the male insert (models marked by ○ in the above table). The series is completed with all range of covers (6 models) matching the various applications.

- Series **CKH-MKH Hygienic** made (like T-Type Hygienic) by thermoplastic insulating materials compatible with the temperature range of standard hygienic applications and qualified for resistance to a wide set of cleaning agents by ECOLAB, and in compliance with the EHEDG Guideline no. 32. Same for the material of the locking lever and that of the sealing gaskets (flange, interface and under the head of fixing screw).

- Moving parts (locking lever) or parts that might be lost (sealing gaskets) blue coloured to be easily detectable by remote image detection systems.

- Locking lever detectable by metal detectors in case of accidental loss and fall inside the conveyor belt (food path).

- IP degree of protection: **IP66/IP67/IP69**.

- Upper and Lower Limiting Temperature (ULT – LLT): -40 °C ... +70 °C.

inserts

CK	3 and 4 poles + ⊕	58
CKS	3 and 4 poles + ⊕	-
CKSH	3 and 4 poles + ⊕	63
CD	7 poles + ⊕	66
CD4	8 poles + ⊕	67
CQ4	2 poles + ⊕	182
CQ4 H	2 poles + ⊕	183
CQ4	3 poles + ⊕	184
CQ4	3+2 (aux) poles + ⊕	16 *
CQ	5 poles + ⊕	186
CQ	7 poles + ⊕	187
CQ	12 poles + ⊕	189
CQ	21 poles + ⊕	190

only for I (straight) housings  
(if the counterpart has glued gasket):

CJ KF	223
CJK 8FT	226
CJK 8IFT	228
CUK 2FT, CUK 3FT	236
CLK 04 SC	239
CX 1/2 BD	243
CXL 2/4 SF, CXL 2/4 SM	250
CXL SF, CXL SM	250

refer to CN.19 pages  
\* refer to NEWS 2020 pages

pages:

bulkhead mounting housings



angled bulkhead mounting housings

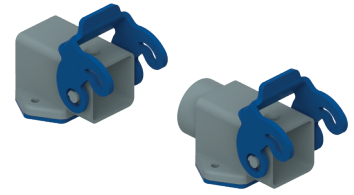

description	part No.	part No.	part No. (entry M20)
-------------	----------	----------	-------------------------

with lever 2)	CKH 03 I		
without cable entry, with lever 1) 2)		CKH 03 IA	
with cable entry, lever 1) 2)			MKH IAP20

1) Not suitable for inserts:

- CQ4 2 poles + ⊕
- CQ4 H 2 poles + ⊕
- CQ4 3 poles + ⊕
- CQ4 3+2 (aux) poles + ⊕

2) CKRH 65 and CKRH 65 D **included** with all hoods and housings, to replace the fixing screw provided with the insert: CKRH 65 D for CD 07 and CD 08 inserts, CKRH 65 all the others.

NOTE: The enclosure shown here is an example. The screw and sealing gasket kit can be used with all enclosures' part nos. in this page.

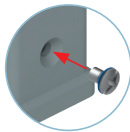

CKH I

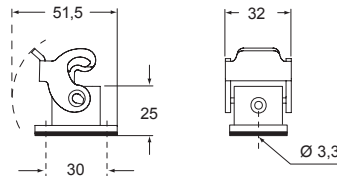

CKH IA

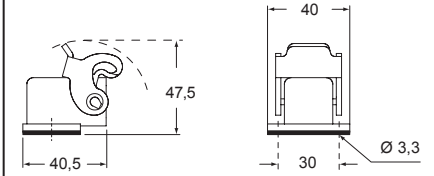

MKH IAP

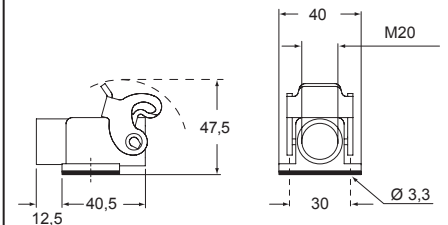

HOUSING KIT EXAMPLE



panel cut-out for enclosures

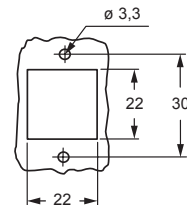

panel cut-out for enclosures

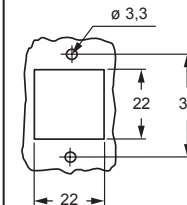

us (ECBT2.E115072, ECBT8.E115072)  
Type 12, Type 4/4X only with CKRH 65 (D),  
DNV certified;  
CQC, BV pending



# CKH - MKH production lines HYGIENIC SERIES

## inserts

pages:

CK	3 poles + ⊕	58
CK	4 poles + ⊕	58
CKS	3 poles + ⊕	-
CKS	4 poles + ⊕	-
CKSH	3 poles + ⊕	63
CKSH	4 poles + ⊕	63
CD	7 poles + ⊕	66
CD	8 poles	67
CQ4M	2 poles + ⊕	182
CQ4M H	2 poles + ⊕	183
CQ4M	3 poles + ⊕	184
CQ4M	3+2 (aux) poles + ⊕	16 *
CQ	5 poles + ⊕	186
CQ	7 poles + ⊕	187
CQ	12 poles + ⊕	189
CQ	21 poles	190

refer to CN.19 pages

## hoods

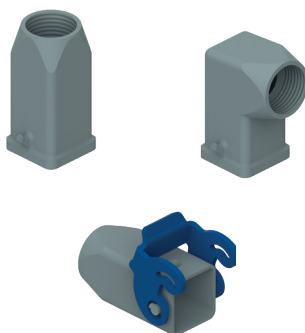

## covers

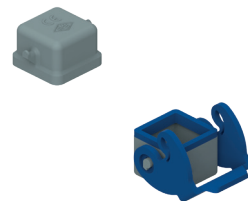

description	part No. (entry M20)	part No. (with eyelet)	part No. (with loop)
with pegs and CR 21.21 GMH gasket, top entry <sup>1) 2)</sup>	<b>MKH V20</b>		
with pegs and CR 21.21 GMH gasket, side entry <sup>1) 2)</sup>	<b>MKH VA20</b>		
with lever, top entry <sup>1) 2)</sup>	<b>MKH VG20</b>		
with pegs and gasket, for female inserts		<b>CKH 03 C</b>	<b>CKH 03 CS</b>
with pegs, for male inserts		<b>CKH 03 CA</b>	<b>CKH 03 CAS</b>
with lever and gasket, for female inserts			<b>CKH 03 CX</b>
with lever, for male inserts			<b>CKH 03 CXA</b>

### 1) Not suitable for inserts:

- CQ4 2 poles + ⊕
- CQ4 H 2 poles + ⊕
- CQ4 3 poles + ⊕
- CQ4 3+2 (aux) poles + ⊕

2) **CKRH 65** and **CKRH 65 D** included with all hoods and housings, to replace the fixing screw provided with the insert: CKRH 65 D for CD 07 and CD 08 inserts, CKRH 65 all the others.

NOTE: The enclosure shown here is an example. The screw and sealing gasket kit can be used with all enclosures' part nos. in this page.

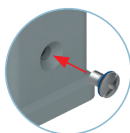

**CR 21.21 GMH HYGIENIC gasket for male inserts "21.21" size included in the hoods, also available as spare parts (see page 114)**



### HOOD KIT EXAMPLE



CE mark (ECBT2.E115072, ECBT8.E115072)  
Type 12, Type 4/4X only with CKRH 65 (D),  
DNV certified;  
CQC, BV pending



### MKH V

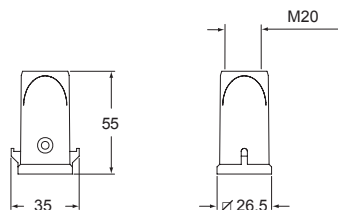

### MKH VA

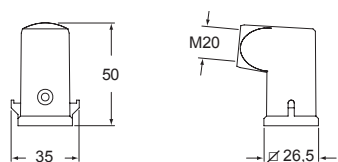

### MKH VG

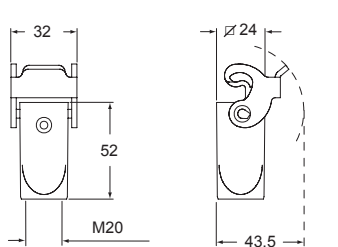

### CKH C - CKH CS

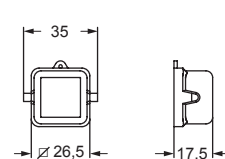

### CKH CA - CKH CAS

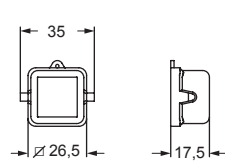

### CKH CX

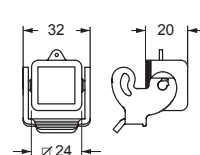

### CKH CXA

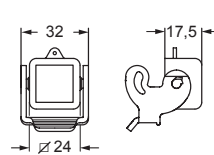

### For fixing on housings

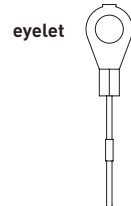

### For fixing on hoods

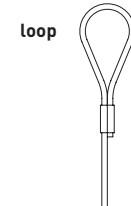

# MKH production lines HYGIENIC SERIES

**inserts**

<b>CK</b>	3 and 4 poles + ⊕	<b>58</b>
<b>CKS</b>	3 and 4 poles + ⊕	-
<b>CKSH</b>	3 and 4 poles + ⊕	<b>63</b>
<b>CD</b>	7 poles + ⊕	<b>66</b>
<b>CD</b>	8 poles	<b>67</b>
<b>CQ4</b>	2 poles + ⊕	<b>182</b>
<b>CQ4 H</b>	2 poles + ⊕	<b>183</b>
<b>CQ4</b>	3 poles + ⊕	<b>184</b>
<b>CQ4</b>	3+2 (aux) poles + ⊕	<b>16 *</b>
<b>CQ</b>	5 poles + ⊕	<b>186</b>
<b>CQ</b>	7 poles + ⊕	<b>187</b>
<b>CQ</b>	12 poles + ⊕	<b>189</b>
<b>CQ</b>	21 poles	<b>190</b>

pages:

**hood**



refer to CN.19 pages

\* refer to NEWS 2020 pages

description

part No.  
(entry M25)

with pegs and CR 21.21 GMH gasket, top entry <sup>1)</sup>

**MKH V25**

<sup>1)</sup> **CKRH 65** and **CKRH 65 D** **included** with all hoods and housings, to replace the fixing screw provided with the insert: CKRH 65 D for CD 07 and CD 08 inserts, CKRH 65 all the others.

NOTE: The enclosure shown here is an example. The screw and sealing gasket kit can be used with all enclosures' part nos. in this page.

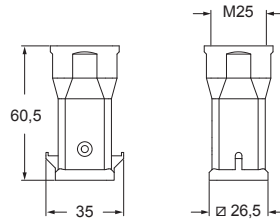
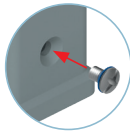

**CR 21.21 GMH HYGIENIC gasket for male inserts "21.21" size** **included** in the hoods, also available as spare parts (see page 114)



**HOOD KIT EXAMPLE**



CE mark (ECBT2.E115072, ECBT8.E115072)  
Type 12, Type 4/4X only with CKRH 65 (D),  
DNV certified;  
CQC, BV pending



# MKH production lines HYGIENIC SERIES

inserts	pages:
CK	3 and 4 poles + ⊕ 58
CKS	3 and 4 poles + ⊕ -
CKSH	3 and 4 poles + ⊕ 63
CD	7 poles + ⊕ 66
CD	8 poles 67
CQ4	2 poles + ⊕ 182
CQ4 H	2 poles + ⊕ 183
CQ4	3 poles + ⊕ 184
CQ4	3+2 (aux) poles + ⊕ 16 *
CQ	5 poles + ⊕ 186
CQ	7 poles + ⊕ 187
CQ	12 poles + ⊕ 189
CQ	21 poles 190
CLK 04 SC	239
CX 1/2 BD	243
CXL 2/4 PF, CXL 2/4 PFH	251
CXL 2/4 PM, CXL 2/4 PMH	251
CXL PF, CXL PM	251

refer to CN.19 pages  
\* refer to NEWS 2020 pages

## hood

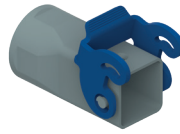

description	part No. (entry M25)
-------------	-------------------------

with lever, top entry 1)

### MKH VG25

1) **CKRH 65** and **CKRH 65 D** **included** with all hoods and housings, to replace the fixing screw provided with the insert: CKRH 65 D for CD 07 and CD 08 inserts, CKRH 65 all the others.

NOTE: The enclosure shown here is an example. The screw and sealing gasket kit can be used with all enclosures' part nos. in this page.

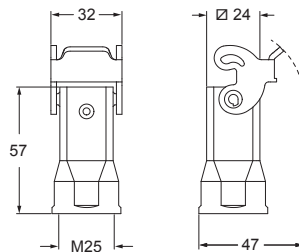
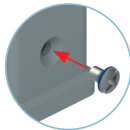

### HOOD KIT EXAMPLE



(ECBT2.E115072, ECBT8.E115072)  
Type 12, Type 4/4X only with CKRH 65 (D),  
 certified;  
CQC, BV pending



<b>inserts</b>	<b>pages:</b>
CJ KM	223
CJK 8MT	226
CJK 8IMT *	226, 228
CUK 2FT	236
CUK 3FT	236
CLK 04 SC *	239
CX 1/2 BD	243
CXL 2/4 PF	251
CXL 2/4 PFH	251
CXL 2/4 PM	251
CXL 2/4 PMH	251
CXL PF	251
CXL PM	251

\* cannot be used with angled enclosures (part No. MKGH VA20)

refer to CN.19 pages

**hood with glued gasket**

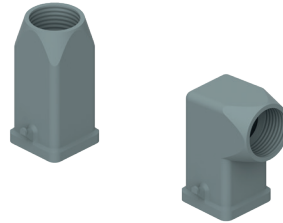

description	part No. (entry M20)
-------------	----------------------

with pegs and glued gasket, top entry <sup>1)</sup>  
with pegs and glued gasket, side entry <sup>1)</sup>

**MKGH V20**  
**MKGH VA20**

▲ Suitable for DESINA® CXL inserts and male inserts without gasket.

<sup>1)</sup> CKRH 65 and CKRH 65 D **included** with all hoods and housings, to replace the fixing screw provided with the insert: CKRH 65 D for CD 07 and CD 08 inserts, CKRH 65 all the others.

NOTE: The enclosure shown here is an example. The screw and sealing gasket kit can be used with all enclosures' part nos. in this page.

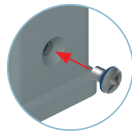

**HOOD KIT EXAMPLE**



**MKGH V**

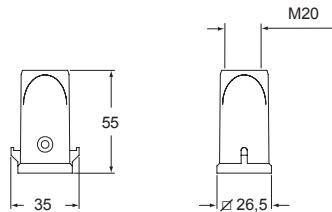

**MKGH VA**

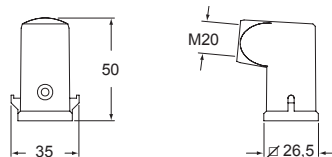

us (ECBT2.E115072, ECBT8.E115072)  
Type 12, Type 4/4X, certified;  
CQC, BV pending





<b>inserts</b>	<b>pages:</b>
CJ KM	223
CJK 8MT	226
CJK 8IMT	226, 228
CJK 8M	233
CUK 2FT, CUK 3FT	236
CLK 04 SC	239
CX 1/2 BD	243
CXL 2/4 PF, CXL 2/4 PFH	251
CXL 2/4 PM, CXL 2/4 PMH	251
CXL PF, CXL PM	251

**hood with glued gasket**



refer to CN.19 pages

description	part No. (entry M25)
-------------	-------------------------

with pegs, top entry 1)

**MKGH V25**

▲ Suitable for DESINA® CXL inserts and male inserts without gasket.

1) **CKRH 65** and **CKRH 65 D** **included** with all hoods and housings, to replace the fixing screw provided with the insert: CKRH 65 D for CD 07 and CD 08 inserts, CKRH 65 all the others.

NOTE: The enclosure shown here is an example. The screw and sealing gasket kit can be used with all enclosures' part nos. in this page.

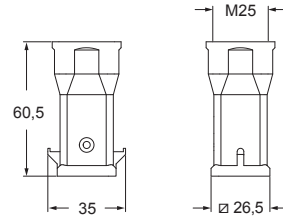
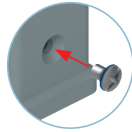

**HOOD KIT EXAMPLE**



CE us (ECBT2.E115072, ECBT8.E115072)  
Type 12, Type 4/4X, certified;  
CQC, BV pending



**inserts**

<b>CKM</b>	3 and 4 poles + ⊕	<b>58</b>
<b>CKSM</b>	3 and 4 poles + ⊕	-
<b>CKSHM</b>	3 and 4 poles + ⊕	<b>63</b>
<b>CDM</b>	7 poles + ⊕	<b>66</b>
<b>CDM</b>	8 poles	<b>67</b>
<b>CQ4M</b>	2 poles + ⊕	<b>182</b>
<b>CQ4M H</b>	2 poles + ⊕	<b>183</b>
<b>CQ4M</b>	3 poles + ⊕	<b>184</b>
<b>CQ4M</b>	3+2 (aux) poles + ⊕	<b>16 *</b>
<b>CQM</b>	5 poles + ⊕	<b>186</b>
<b>CQM</b>	7 poles + ⊕	<b>187</b>
<b>CQM</b>	12 poles + ⊕	<b>189</b>
<b>CQM</b>	21 poles	<b>190</b>

pages:

**HYGIENIC gasket for "21.21" male inserts**



**gasket and screw kit for HYGIENIC**



refer to CN.19 pages  
\* refer to NEWS 2020 pages

description	part No.	part No.
HYGIENIC gasket for male inserts "21.21" size	<b>CR 21.21 GMH</b>	
gasket and screw kit for IP66/IP67/IP69		<b>CKRH 65</b>
gasket and screw kit for IP66/IP67/IP69 specific for CD 07/08 inserts		<b>CKRH 65 D</b>

**! CAUTION:**

This gasket **CR 21.2 GMH** must replace the standard gasket on the male insert, that foresees a gasket.

**NOTE:**

Just in case of use of the housing or hood with lever together with the male insert, and without ordering the corresponding hood, it is necessary to require separately the **CR 21.21 GMH** HYGIENIC gasket for male insert.  
For consistency, also the covers are supplied in single pack.

**CR 21.21 GMH**

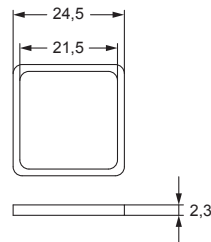

**CKRH 65**

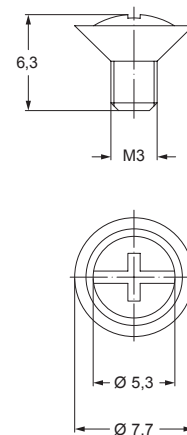

**CKRH 65 D**

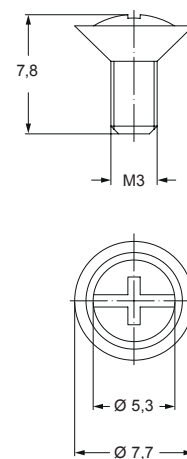

## CKH - MKH HYGIENIC ENCLOSURES

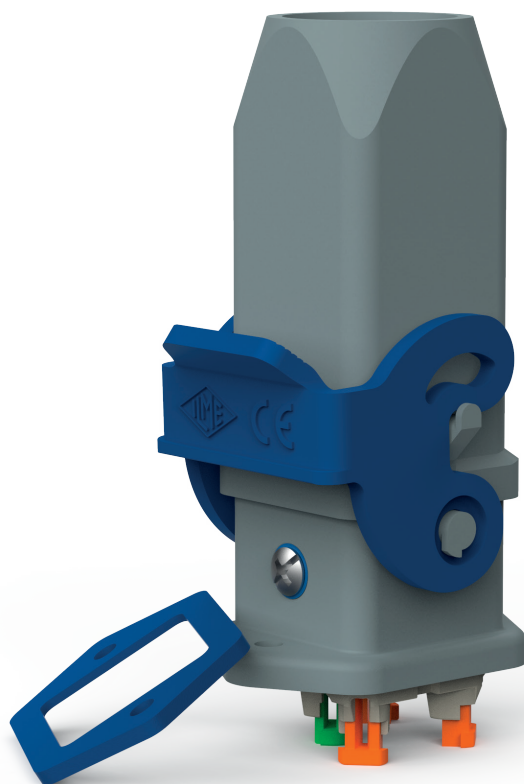

---

## T-TYPE ENCLOSURES WITH INTEGRATED PROTECTIVE EARTH JUMPERS

---



Special version of the T-TYPE enclosures  
with pre-installed protective earth jumpers  
to put remedy to undetected incorrect PE wiring



Find more  
information on  
our products at  
[www.ilme.com](http://www.ilme.com)

## TECHNICAL FEATURES

### T-TYPE ENCLOSURES WITH INTEGRATED PE JUMPERS

- Available **upon request** (product not managed on stock) for all version of T-TYPE enclosures (covers not included):  
**Standard, T-TYPE /W, Hygienic /H and Hygienic /C** with pre-installed PE jumpers (also known as “bridges” hence the suffix B to identify such variants).
- Relieves the duty to install the optional CR 06 /10 /16 /24 BPE protective earth jumpers into the T-TYPE insulating enclosures.
- In case the wiring of the connectors is done by unskilled persons, the PE jumpers grants the continuity of the protective earth path between male and female connectors even in case of PE wiring mistake and omitted test for continuity of PE (which is nonetheless a legally obligatory test on wired devices and equipment prior to their put into service).
- Already covered by approval with Type 1, 2, 12 ratings.

#### Series T-TYPE enclosures with optional protective earth jumpers CR...BPE preassembled

Enclosures with protective earth jumpers CR...BPE preassembled are available **upon request from June 2020**, with Part no. of base model plus **letter B** at the end.

Size	Cable outlet	Locking lever	T-TYPE Standard Part no.	T-TYPE W Part no.	T-TYPE Hygienic Part no.	T-TYPE Hygienic Cold Part no.
44.27	-	single	TCHI 06 LB	THIW 06 LB	THIH 06 LB	THIC 06 LB
57.27	-	double	TCHI 10 B	THIW 10 B	THIH 10 B	THIC 10 B
77.27	-	double	TCHI 16 B	THIW 16 B	THIH 16 B	THIC 16 B
104.27	-	double	TCHI 24 B	THIW 24 B	THIH 24 B	THIC 24 B
44.27	M25	single	TMAP 06L25B	TAPW 06L25B	TAPH 06L25B	TAPC 06L25B
44.27	M32	single	TMAP 06L32B	TAPW 06L32B	TAPH 06L32B	TAPC 06L32B
44.27	<b>2xM25*</b>	single	TMAP06L225B	TAPW06L225B	TAPH06L225B	TAPC06L225B
44.27	<b>2xM32*</b>	single	TMAP06L232B	TAPW06L232B	TAPH06L232B	TAPC06L232B
57.27	M25	double	TMAP 10.25B	TAPW 10.25B	TAPH 10.25B	TAPC 10.25B
57.27	M32	double	TMAP 10.32B	TAPW 10.32B	TAPH 10.32B	TAPC 10.32B
57.27	<b>2xM25*</b>	double	TMAP10.225B	TAPW10.225B	TAPH10.225B	TAPC10.225B
57.27	<b>2xM32*</b>	double	TMAP10.232B	TAPW10.232B	TAPH10.232B	TAPC10.232B
77.27	M32	double	TMAP 16.32B	TAPW 16.32B	TAPH 16.32B	TAPC 16.32B
77.27	M40	double	TMAP 16.40B	TAPW 16.40B	TAPH 16.40B	TAPC 16.40B
77.27	<b>2xM32*</b>	double	TMAP16.232B	TAPW16.232B	TAPH16.232B	TAPC16.232B
77.27	<b>2xM40*</b>	double	TMAP16.240B	TAPW16.240B	TAPH16.240B	TAPC16.240B
104.27	M32	double	TMAP 24.32B	TAPW 24.32B	TAPH 24.32B	TAPC 24.32B
104.27	M40	double	TMAP 24.40B	TAPW 24.40B	TAPH 24.40B	TAPC 24.40B
104.27	<b>2xM32*</b>	double	TMAP24.232B	TAPW24.232B	TAPH24.232B	TAPC24.232B
104.27	<b>2xM40*</b>	double	TMAP24.240B	TAPW24.240B	TAPH24.240B	TAPC24.240B
44.27	M25	-	TMAO 06L25B	-	-	-
44.27	M32	-	TMAO 06L32B	-	-	-
57.27	M25	-	TMAO 10.25B	-	-	-
57.27	M32	-	TMAO 10.32B	-	-	-
77.27	M32	-	TMAO 16.32B	-	-	-
77.27	M40	-	TMAO 16.40B	-	-	-
104.27	M32	-	TMAO 24.32B	-	-	-
104.27	M40	-	TMAO 24.40B	-	-	-
44.27	M25	-	TMAV 06L25B	-	-	-
44.27	M32	-	TMAV 06L32B	-	-	-
57.27	M25	-	TMAV 10.25B	-	-	-
57.27	M32	-	TMAV 10.32B	-	-	-
77.27	M32	-	TMAV 16.32B	-	-	-
77.27	M40	-	TMAV 16.40B	-	-	-
104.27	M32	-	TMAV 24.32B	-	-	-
104.27	M40	-	TMAV 24.40B	-	-	-
44.27	M25	single	TMAV06LG25B	TAVW06LG25B	TAVH06LG25B	TAVC06LG25B
44.27	M32	single	TMAV06LG32B	TAVW06LG32B	TAVH06LG32B	TAVC06LG32B
57.27	M25	double	TMAV 10G25B	TAVW 10G25B	TAVH 10G25B	TAVC 10G25B
57.27	M32	double	TMAV 10G32B	TAVW 10G32B	TAVH 10G32B	TAVC 10G32B
77.27	M32	double	TMAV 16G32B	TAVW 16G32B	TAVH 16G32B	TAVC 16G32B
77.27	M40	double	TMAV 16G40B	TAVW 16G40B	TAVH 16G40B	TAVC 16G40B
104.27	M32	double	TMAV 24G32B	TAVW 24G32B	TAVH 24G32B	TAVC 24G32B
104.27	M40	double	TMAV 24G40B	TAVW 24G40B	TAVH 24G40B	TAVC 24G40B

\* New versions with two cable entries opened are available **upon request from June 2020** also in standard version without PE jumpers.

---

## BIG HOODS WITH INTEGRATED SPECIAL SELF-CENTRING FLOATING FRAME

---



Size "104.27" BIG hoods  
available in 2x M40 top cable entries  
and 1x M40 top cable entry  
with integrated special self-centring  
floating frame



Find more  
information on  
our products at  
[www.ilme.com](http://www.ilme.com)

## TECHNICAL FEATURES

### MBV 24.240D, MBV 24.240DG, MBV 24.40D, MBV 24.40DG

- These **special variants of the series BIG connector enclosures** (a series which is **proprietary ILME design**), available in the largest size “104.27”, consist of two hoods, one with edge gasket, the other without, both equipped with dedicated variant of robust stainless steel special self-centring floating frame.
- They are designed to allow electrical (power and signal) connection between two pieces of equipment (both fixed, one foreseen for frequent swap), guided by a dedicated special self-centring floating frame allowing **up to  $\pm 1,5$  mm off axis in both directions on a plane**, to create an internal protected space for the wiring on both sides of the connection. This is particularly handy e.g. for the rapid change of the moulds on a moulding press machine.
- Thanks to the integrated “*key and keyway*” system (two sets of facing robust pin and contact tubes, one on each short side, mounted on custom-tailored robust stainless steel plates integrated in the mating face of the size “104.27” mating hoods) the connector inserts housed inside the hoods avoid mechanical damages during mating and take advantage of the protective large wiring space of the BIG enclosures.
- Thanks to the sealing gasket on the coupling, provided sufficient tight closure is ensured by the assembly on the machine (not possible to integrate any locking), the IP degree of protection up to IP66/IP67/IP69 may be achieved.
- Generously dimensioned stainless steel parts provide suitable mechanical robustness and resistance to corrosion.
- Available parts:
  - **MBV 24.240D** size “104.27” hood series BIG with **2x M40** top cable entries and integrated special self-centring floating frame, to be exclusively mated with:
  - **MBV 24.240DG** size “104.27” hood with gasket, series BIG, with **2x M40** top cable entries and integrated special self-centring floating frame;
  - **MBV 24.40D** size “104.27” hood series BIG with **1x M40** top cable entry and integrated special self-centring floating frame, to be exclusively mated with:
  - **MBV 24.40DG** size “104.27” hood with gasket, series BIG, with **1x M40** top cable entry and integrated special self-centring floating frame.
- These BIG special hoods are deemed to be used only in combination among themselves: one part without gasket, the mating part with gasket.
- Up to 10 000 matings are achievable once used with HNM inserts with HNM series R crimp contacts as applicable and MIXO HNM frames as applicable, up to 500 matings guaranteed using standard components within these special BIG enclosures.
- Tolerance for off-axis displacement (allowed by the integral self-centring floating frame):  $x \pm 1,5$  mm,  $y \pm 1,5$  mm.

**BIG special hoods with integrated special self-centring floating frame allow guided, frequent swaps avoiding damages and ingress of contaminants**

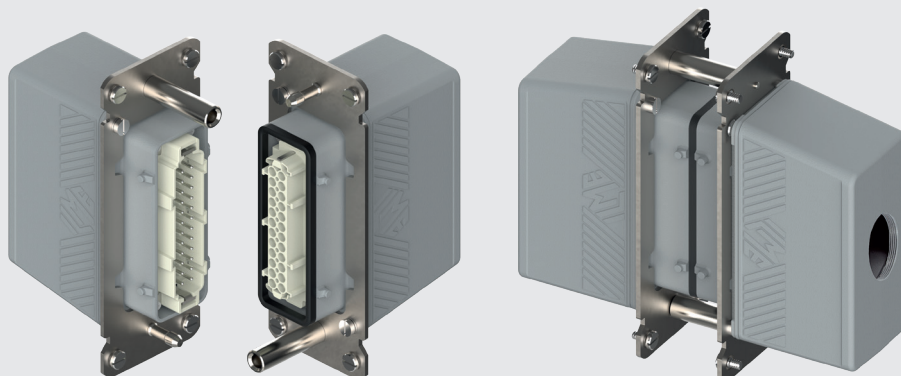



# MBV BIG hoods with integrated special self-centring floating frame

**inserts**

CD	64 poles + ⊕	72
CDD	108 poles + ⊕	81
CDS	42 poles + ⊕	-
CDSH	42 poles + ⊕	89
CNE	24 poles + ⊕	113
CSE	24 poles + ⊕	-
CSH	24 poles + ⊕	113
CSH S	24 poles + ⊕	125
CCE	24 poles + ⊕	133
CMSH	10+2 (aux) poles + ⊕	140
CMCE	10+2 (aux) poles + ⊕	141
CSS	24 poles + ⊕	151
CT, CTSE (16A)	24 poles + ⊕	163
CQE	46 poles + ⊕	171
CQEE	64 poles + ⊕	177
CX	4/8 and 6/6 poles + ⊕	204, 206
MIXO	6 modules	262 - 317

pages:

hoods with integrated special self-centring floating frame



hoods with integrated special self-centring floating frame and gasket



refer to CN.19 pages

description	part No.	entry M	part No.	entry M
1x M40 top entry	<b>MBV 24.40D</b>	40 x 1	<b>MBV 24.40DG</b>	40 x 1
1x M40 top entry, with gasket				

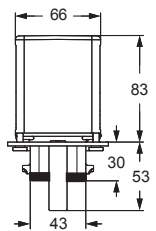
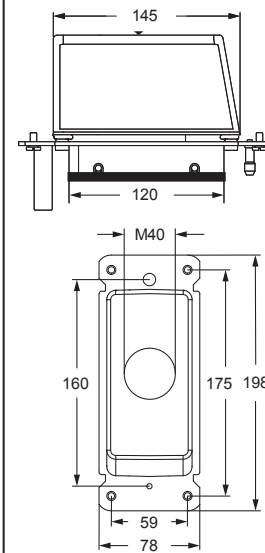
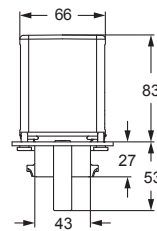
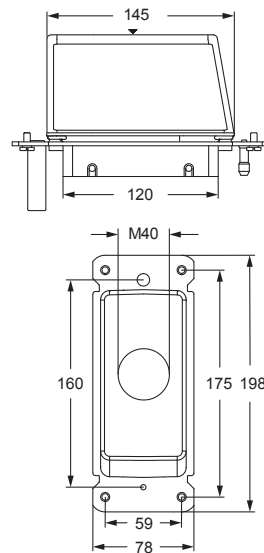

panel cut-out for enclosures

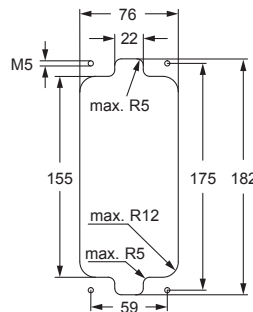

panel cut-out for enclosures

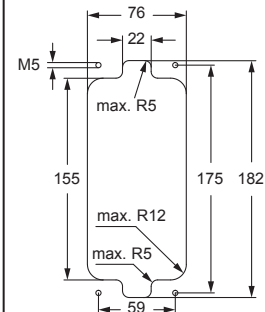

**! CAUTION:** Due to the absence of locking means, the IP66/IP67/IP69 achievable degree of protection is demanded to the end-use application:

- 1) Suitable pressure, in order to uniformly compress the sealing gasket and keep the connector coupling tight is required: this condition is satisfied when the self-centring guide pins and contact tubes reach their end-of-run and are kept constantly in this position;
- 2) Suitably rated cable entry devices (e.g. cable glands) are required to maintain the desired IP degree of protection.

Protection against undue opening under load (connectors without breaking capacity) and closing under voltage is demanded to the end-use application, e.g. by suitable detection of such conditions.

# MBV BIG hoods with integrated special self-centring floating frame

**inserts**

CD	64 poles + ⊕	72
CDD	108 poles + ⊕	81
CDS	42 poles + ⊕	-
CDSH	42 poles + ⊕	89
CNE	24 poles + ⊕	113
CSE	24 poles + ⊕	-
CSH	24 poles + ⊕	113
CSH S	24 poles + ⊕	125
CCE	24 poles + ⊕	133
CMSH	10+2 (aux) poles + ⊕	140
CMCE	10+2 (aux) poles + ⊕	141
CSS	24 poles + ⊕	151
CT, CTSE (16A)	24 poles + ⊕	163
CQE	46 poles + ⊕	171
CQEE	64 poles + ⊕	177
CX	4/8 and 6/6 poles + ⊕	204, 206
MIXO	6 modules	262 - 317

refer to CN.19 pages

pages:

hoods with integrated special self-centring floating frame



hoods with integrated special self-centring floating frame and gasket



description	part No.	entry M	part No.	entry M
2x M40 top entries	<b>MBV 24.240D</b>	40 x 2		
2x M40 top entries, with gasket			<b>MBV 24.240DG</b>	40 x 2

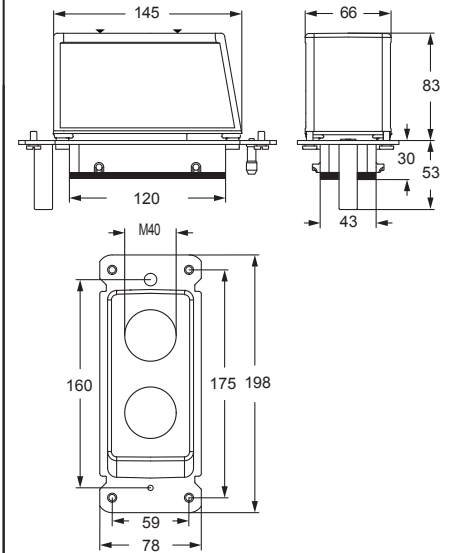
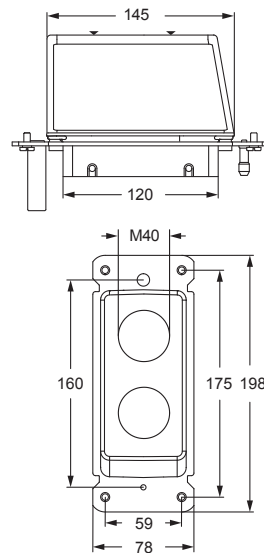

panel cut-out for enclosures

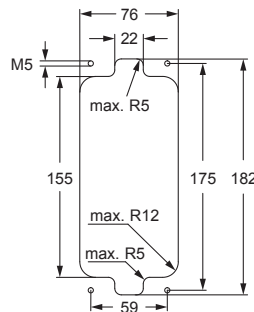

panel cut-out for enclosures

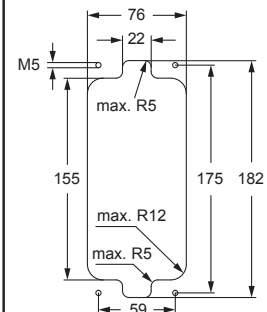

**! CAUTION:** Due to the absence of locking means, the IP66/IP67/IP69 achievable degree of protection is demanded to the end-use application:

- 1) Suitable pressure, in order to uniformly compress the sealing gasket and keep the connector coupling tight is required: this condition is satisfied when the self-centring guide pins and contact tubes reach their end-of-run and are kept constantly in this position;
- 2) Suitably rated cable entry devices (e.g. cable glands) are required to maintain the desired IP degree of protection.

Protection against undue opening under load (connectors without breaking capacity) and closing under voltage is demanded to the end-use application, e.g. by suitable detection of such conditions.

# MBV BIG hoods with integrated special self-centring floating frame

## ASSEMBLY INSTRUCTIONS

### BIG HOODS WITH INTEGRATED SPECIAL SELF-CENTRING FLOATING FRAME



Watch our online tutorial

#### 1 HOOD CLOSING

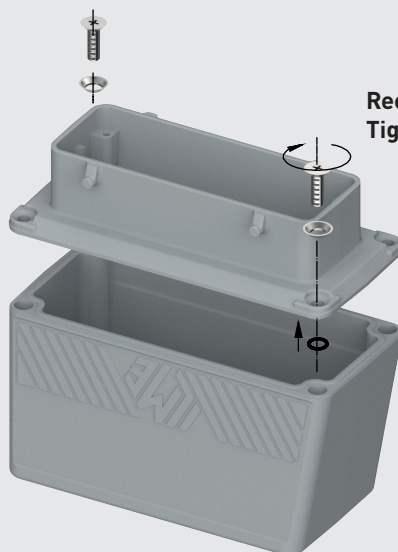

Recommended size of screwdriver: Ph2  
Tightening torque: 1,6 Nm

#### 2 SPECIAL SELF-CENTRING FLOATING FRAME ASSEMBLY

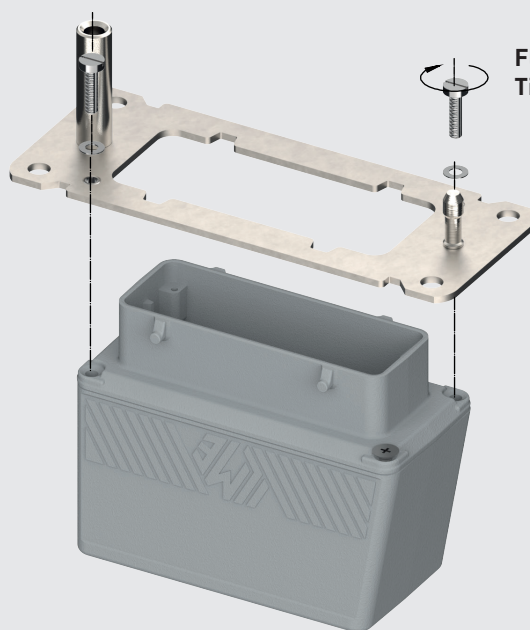

Flat screw driver 10,0 x 1,2 mm  
Tightening torque: 1,8 Nm

#### 3 INSTALLATION ON THE PANEL

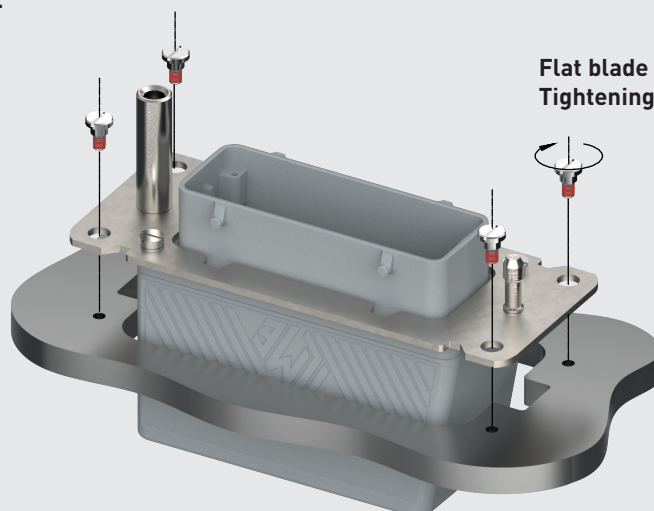

Flat blade 10,0 x 1,2 mm  
Tightening torque: 2,5 Nm

## ASSEMBLY INSTRUCTIONS

## BIG HOODS WITH INTEGRATED SPECIAL SELF-CENTRING FLOATING FRAME

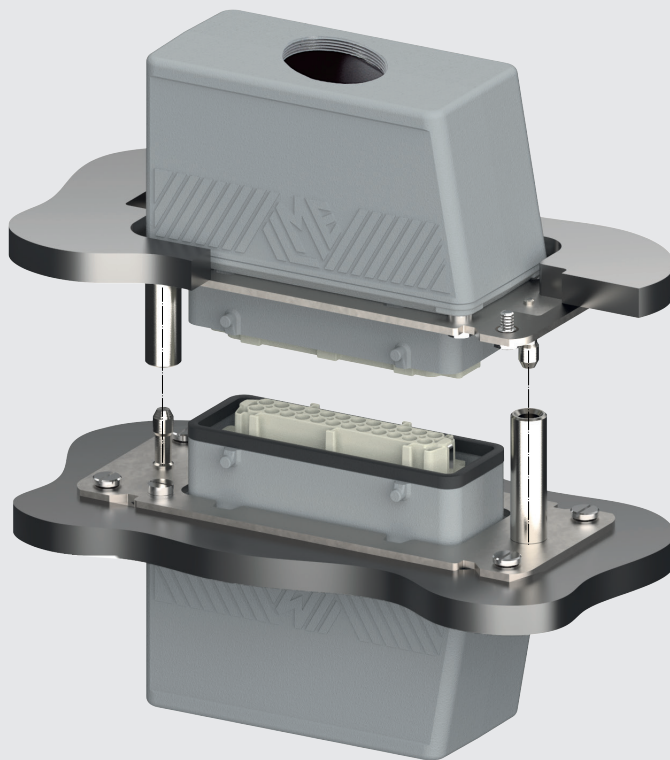
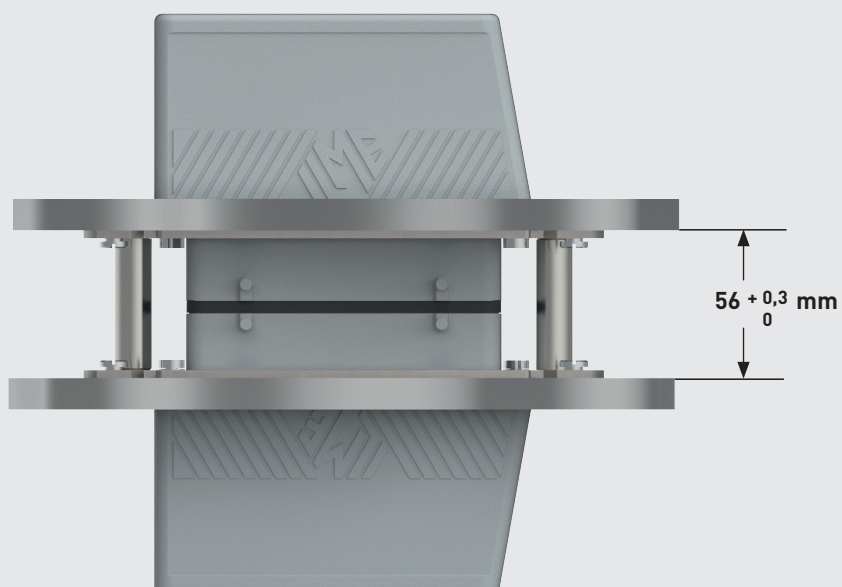

Watch  
our online  
tutorial

**4** INSTALLATION ON THE PANELS**5** CLOSING DISTANCE BETWEEN PANELS TO ACHIEVE IP DEGREE OF PROTECTION

---

## SIZE "66.40" ENCLOSURES WITH FULL METAL LOCKING LEVERS

---



Variants of existing size "66.40"  
standard hoods, housings and covers  
with a full metal stainless steel resilient lever



Find more  
information on  
our products at  
[www.ilme.com](http://www.ilme.com)

## TECHNICAL FEATURES

CHIX, CHPX, CHOX, CAOX, CAVX, MFOX, MFVX

CHIXW, CHPXW

- Variants of existing size "66.40" standard hoods, housings and covers (with 2 "Class" locking levers, with plastic handle) with a full metal **stainless steel resilient lever** (that one used in 180 °C high temperature enclosures size "44.27", same dimension) replacing the standard "Class" levers.
- Levers fitted with stainless steel rolls that reduce the wearing of corresponding pegs on the hood.
- Better fits the need for higher chemical resistance and higher mechanical resistance to impacts at very low temperature.

full metal stainless  
steel levers with  
stainless steel rolls to  
reduce wearing of the  
hood pegs



# CHIX - CHPX and MHPX C-TYPE standard version full metal locking levers

**inserts**

<b>CD</b>	50 poles + ⊕	<b>71</b>
<b>CDD</b>	76 poles + ⊕	<b>80</b>
<b>CDA</b>	32 poles + ⊕	<b>102</b>
<b>CSAH</b>	32 poles + ⊕	<b>103</b>
<b>CDC</b>	32 poles + ⊕	<b>106</b>

insert dimensions:  
2 x (66 x 16) mm

pages:

**bulkhead mounting housings with 2 levers**



**surface mounting housings with 2 levers**



refer to CN.19 pages

description	part No.	part No.	entry Pg	part No.	entry M
with full metal locking levers	<b>CHIX 50</b>				
with full metal locking levers		<b>CHPX 50.21</b>	21	<b>MHPX 50.32</b>	32
with full metal locking levers		<b>CHPX 50.29</b>	29		

The enclosures ensure IP66/IP69 degree of protection (or IP65 for cover versions) when mated and locked with the closing levers.

**CHIX**

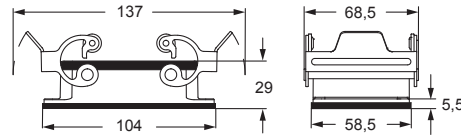

panel cut-out for bulkhead mounting housings

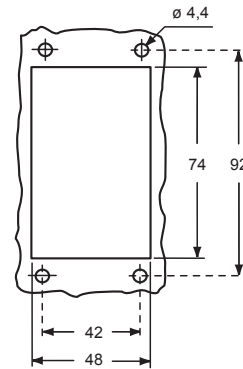

**CHPX and MHPX**

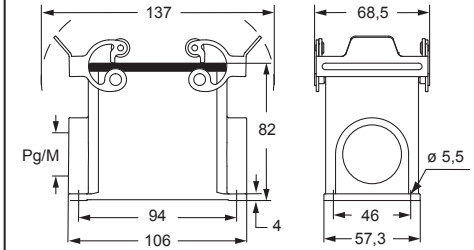

us (ECBT2.E115072, ECBT8.E115072)  
Type 12, Type 4/4X, certified;  
CQC, BV pending







inserts

pages:

CD	50 poles + ⊕	71
CDD	76 poles + ⊕	80
CDA	32 poles + ⊕	102
CSAH	32 poles + ⊕	103
CDC	32 poles + ⊕	106

insert dimensions:  
2 x (66 x 16) mm

refer to CN.19 pages

hoods with 2 levers

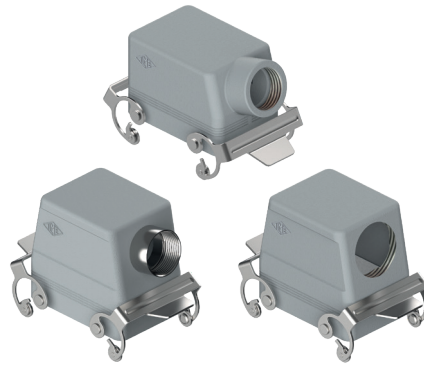

hoods with 2 levers



description	part No.	entry Pg	part No	entry M	part No.	entry Pg	part No.	entry M
with full metal locking levers, side entry <sup>1)</sup>	<b>CHOX 50 X</b>	21	<b>MHOX 50 X32</b>	32				
with full metal locking levers, side entry, high construction <sup>1)</sup>	<b>CAOX 50 X29</b>	29	<b>MAOX 50 X32</b>	32				
with full metal locking levers, top entry, high construction <sup>1)</sup>					<b>CAVX 50 X29</b>	29	<b>MAVX 50 X32</b>	32
with full metal locking levers and gasket, top entry, high construction <sup>1)</sup>					<b>CAVX 50 G29</b>	29	<b>MAVX 50 G32</b>	32
with full metal locking levers, side entry, high construction without adapter <sup>1)2)</sup>			<b>MFOX 50 X32</b>	32				
with full metal locking levers, top entry, high construction without adapter <sup>1)2)</sup>							<b>MFVX 50 X32</b>	32

<sup>1)</sup> May be combined with enclosures:  
CHI 50 CS, CHP 50 CS and MHP 50 CS.

<sup>2)</sup> Enclosure without adapter, threaded on the body, to be used only with a complete cable gland.

The enclosures ensure IP66/IP69 degree of protection (or IP65 for cover versions) when mated and locked with the closing levers.

CHOX X (CAOX X) and MHOX X (MAOX X)

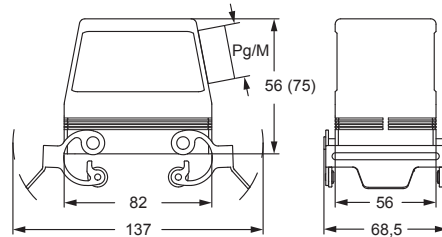

CAVX X and MAVX X - MFVX X

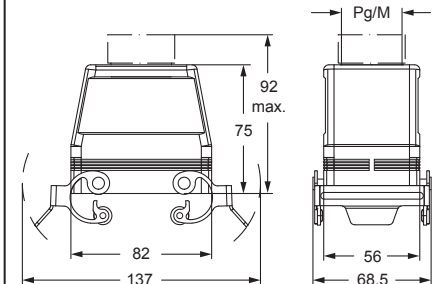

MFOX X

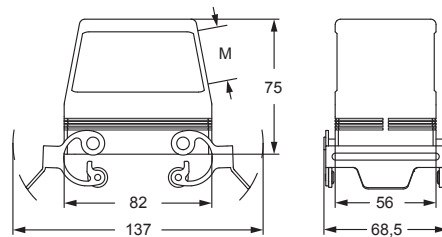

CAVX G and MAVX G

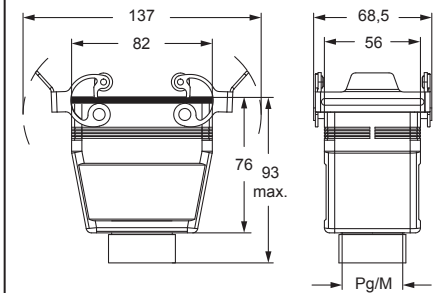

IECus (ECBT2.E115072, ECBT8.E115072)  
Type 12, Type 4/4X, certified;  
CQC, BV pending





**CHCX C-TYPE standard version full metal locking levers**

**inserts**

CD	50 poles + ⊕
CDD	76 poles + ⊕
CDA	32 poles + ⊕
CSAH	32 poles + ⊕
CDC	32 poles + ⊕

pages:

71
80
102
103
106

**covers**



insert dimensions:  
2 x (66 x 16) mm

refer to CN.19 pages

description

part No.

with 2 full metal locking levers and gasket (for hoods with 4 pegs) **CHCX 50 G**

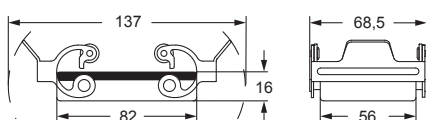

us (ECBT2.E115072, ECBT8.E115072)  
Type 12, Type 4/4X, certified;  
CQC, BV pending



**SIZE "66.40" ENCLOSURES WITH FULL METAL LOCKING LEVERS**



**inserts**

<b>CD</b>	50 poles + ⊕	<b>71</b>
<b>CDD</b>	76 poles + ⊕	<b>80</b>
<b>CDA</b>	32 poles + ⊕	<b>102</b>
<b>CSAH</b>	32 poles + ⊕	<b>103</b>
<b>CDC</b>	32 poles + ⊕	<b>106</b>

insert dimensions:  
2 x (66 x 16) mm

**pages:**

**bulkhead mounting housings with 2 levers**



**surface mounting housings with 2 levers**

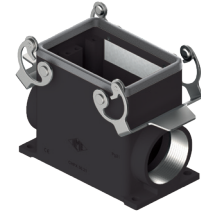

refer to CN.19 pages

description	part No.	part No.	entry Pg	part No.	entry M
with full metal locking levers	<b>CHIXW 50</b>				
with full metal locking levers		<b>CHPXW 50.21</b>	21	<b>MHPXW 50.32</b>	32

The enclosures ensure IP66/IP69 degree of protection (or IP65 for cover versions) when mated and locked with the closing levers.

**CHIXW**

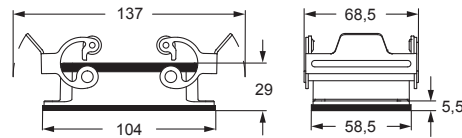

panel cut-out for bulkhead mounting housings

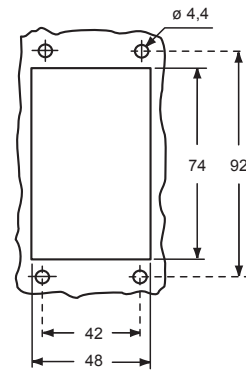

**CHPXW and MHPXW**

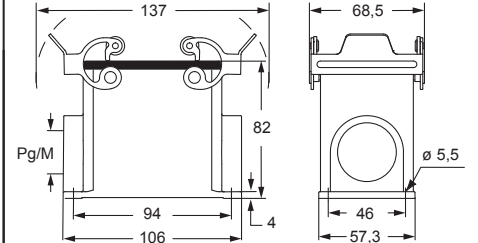

us (ECBT2.E115072, ECBT8.E115072)  
Type 12, Type 4/4X, certified;  
CQC, BV pending

insulating cable gland or fittings without gasket

cable gland with O-Ring gasket

**CHCXW W-TYPE aggressive environments full metal locking levers**

**inserts**

CD	50 poles + ⊕
CDD	76 poles + ⊕
CDA	32 poles + ⊕
CSAH	32 poles + ⊕
CDC	32 poles + ⊕

pages:

71
80
102
103
106

**covers**



insert dimensions:  
2 x (66 x 16) mm

refer to CN.19 pages

description	part No.
-------------	----------

with 2 full metal locking levers and gasket (for hoods with 4 pegs) **CHCXW 50 G**

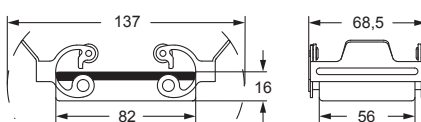

us (ECBT2.E115072, ECBT8.E115072)

Type 12, Type 4/4X, certified;

CQC, BV pending



insulating cable gland or fittings  
without gasket



cable gland  
with O-Ring gasket

---

## COB SUPPORT FOR “21.21” INSERTS FOR DIN RAIL MOUNT

---

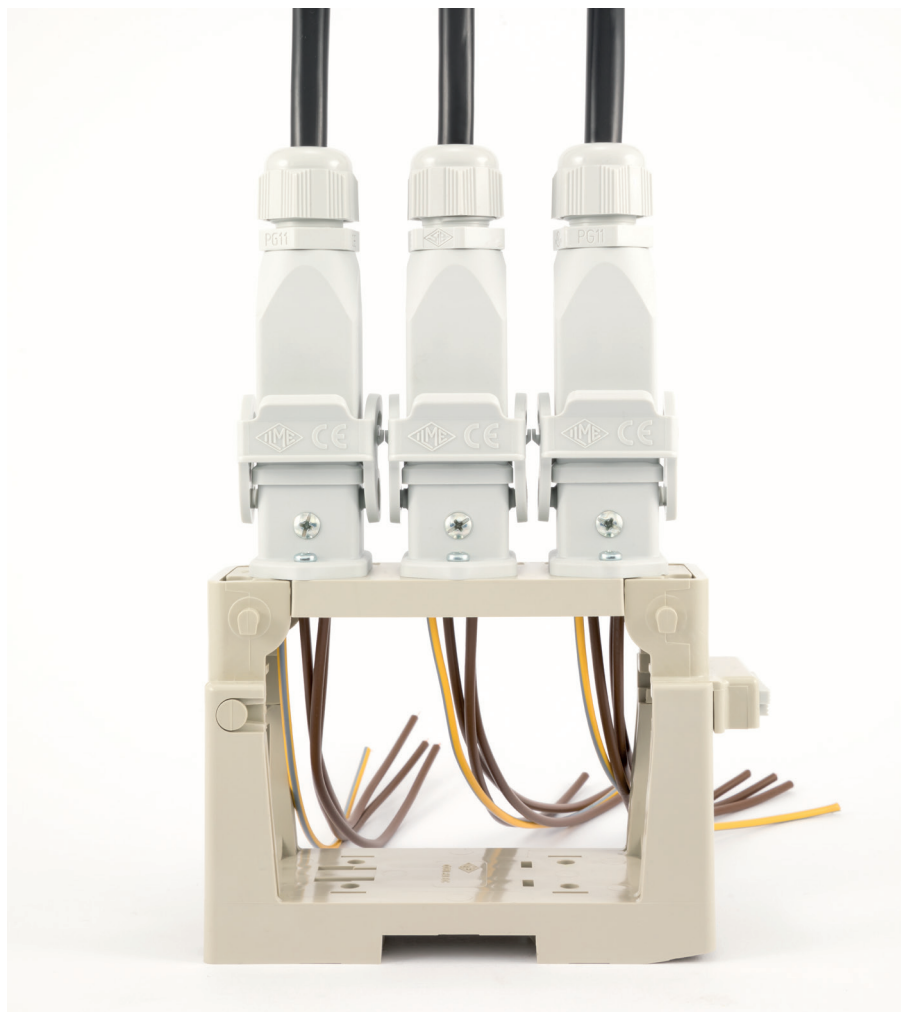

Special COB support suitable  
to be fixed on DIN rail to host  
up to 3 “21.21” inserts



Find more  
information on  
our products at  
[www.ilme.com](http://www.ilme.com)

# TECHNICAL FEATURES

## COB 03/3 BC

The **COB** system of **panel supports** for multipole connectors that allows their installation and use within electric panels without the traditional metallic enclosures, covered until now only those inserts of classic sizes "44.27" through "104.27" and, on a "77.27" COB support completed by the special adapter plates **CR 15/16** and **CR 25/16**, those inserts of compact sizes "49.16" (CD 15, CDA 10, CDC 10, CSAH 10) and "66.16" (CD 25, CDD 38, CDA 16, CDC 16, CSAH 16).

The new **COB 03/3 BC** extends now the same reliable support for use inside control panels to the growing family of inserts sized "21.21": series **CD** (CD 07, CD 08), **CK** (CK 03 /04) and **CKSH** Squich® (CKSH 03 /04), **CQ** (CQ 05, CQ 07, CQ 12, CQ 21) **CQ4** (CQ4 02, CQ4 03) and all the "21.21" adapter inserts for data connectors and/or fibre optic connectors (CJ K, CJZ, CJZA, CJK 8FT /8MT /8IMT /8IFT /8B IFT /8P IFT, CJK 8M, CUK 2FT /3FT, CLK 04 SCF /SCF-H /SCM, CX 1/2 BD, CXL 2/4 ...).

In the "104.27" size of a COB 24 BC, the new hinged pivoting insulating support **COB 03/3 BC**, completed with relevant bulkhead mounting housing CK 03 I (insulating) or CKA(X)(X) 03 I (metal) (to be chosen with the locking lever of preference) and the corresponding hood, provides support to up to three connector inserts size "21.21" with possibility of fixing this new COB 03/3 BC support on a standard DIN EN 60715 rail.

The system discloses new practical applications, introducing the use of connectorized wiring with a vast choice of "21.21" sized connectors in replacement of terminal blocks, in a considerably

reduced space when snapped on crossways on the DIN EN 60715 rail in the cabinet (multiple supports may fit side by side on the rail), with possibility to independently disconnect subsets of connections inside the cabinet (e.g. for faster maintenance, reducing downtime of the control panel).

### Product details:

- **COB 03/3 BC** panel support in self-extinguishing thermoplastic insulating material, sturdy block support structure, with broad passage of outgoing conductor cables from up to 3 "21.21" sized connector inserts installed in relevant housings (to be chosen and purchased separately, either insulating type CK or metal type CKA with the preferred choice of locking lever).
- Holes for fixed installation through fastening screws (when no DIN EN 60715 rail is employed).
- Snap fastening on DIN EN 60715 rails, both lengthways and crossways to the support.
- Seats for bulkhead mounting housings (up to 3) fixing screws (self-tapping screws provided).

c approved (no Type rating assigned as for all series COB already c approved under ECBT2.E115072 and ECBT8.E115082).

Lower and Upper Limiting Temperatures (LLT, ULT):  
-40 °C +125 °C

compatible with  
"21.21" size  
CK 03 I and  
CKA (X) (XX) 03 I  
enclosures  
(not included)

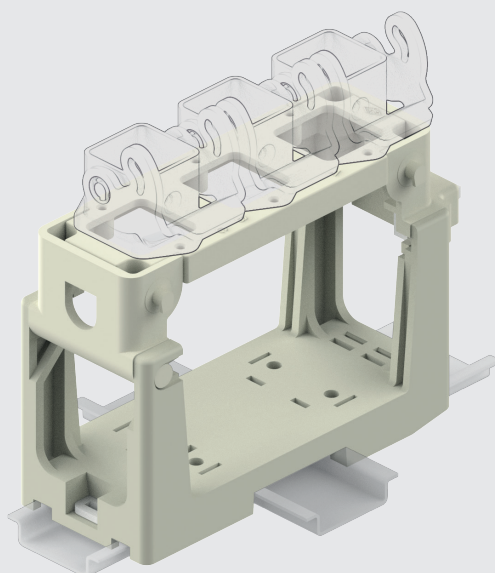

# COB 03/3 BC panel supports for multipole connectors

inserts	pages:
CK	3 and 4 poles + ⊕ 58
CKS	3 and 4 poles + ⊕ -
CKSH	3 and 4 poles + ⊕ 63
CD	7 poles + ⊕ 66
CD	8 poles 67
CQ4	2 poles + ⊕ 182
CQ4	3 poles + ⊕ 184
CQ4	5 poles + ⊕ 186
CQ	7 poles + ⊕ 187
CQ	12 poles + ⊕ 189
CQ	21 poles 190
only for I (straight) housings (if the counterpart has glued gasket):	
CJ K	223
CJZ	224
CJZA	224
CJK 8FT, CJK 8MT	226
CJK 8IFT	228
CJK 8IMT	226, 228
CJK 8B IFT, CJK 8P IFT	228
CJK 8M	233
CUK 2FT, CUK 3FT	236
CLK 04 SC	239
CX 1/2 BD	243
CXL 2/4 SF, CXL 2/4 SM	250

refer to CN.19 pages

connector carrier baseplate for mounting on DIN EN 60715 rail or fixed mounting using screws

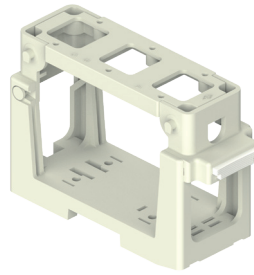

description	part No.
-------------	----------

kit comprising frame and mobile blocks, for insert coupling:  
with screw fixing centre distance of 21 x 21 mm

**COB 03/3 BC**

It is the responsibility of the installer to verify the continuity of the PE protective earth circuit ⊕ between the two halves of the connector.

overall dimensions with longitudinal DIN rails

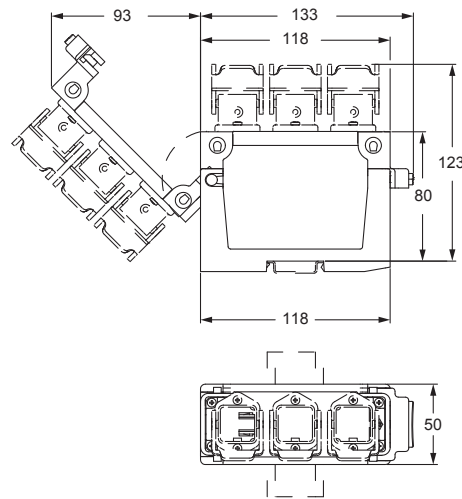

panel cut-out for COB 03/3, for direct fixed mounting without DIN 60715 rails

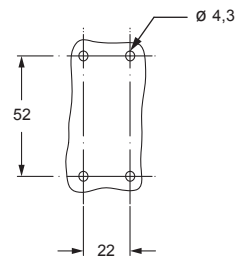

\* overall dimensions with transverse DIN rails  
\*\* overall dimensions without transverse DIN rails

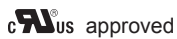
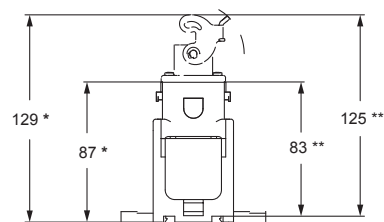

## COB 03/3 BC panel supports for multipole connectors

### PRODUCT DETAILS

For the whole COB Series product details, please refer to pages 650 - 651 of CN.19 catalogue.

### COB 03/3 BC

- 1 Releasable locking of the hinged frame (in **COB...BC** kit) in self-extinguishing thermoplastic material, with quick release device for insert replacement, wiring operations, check and maintenance.
- 2 **COB...BC** hinged panel support for DIN EN 60715 rail mounting (rail not provided) or direct wall fastening with screws (not provided), in self-extinguishing thermoplastic material, sturdy block support structure, with broad passage for housing of conductor cables.
- 3 Holes for direct wall fastening with screws without DIN EN 60715 rails.
- 4 Snap fastening on DIN EN 60715 rails, both lengthways and crossways to the support.
- 5 Releasable rollover hinging pins.
- 6 Adapter plate for up to 3 bulkhead mounting enclosures size "21.21" (not provided), for "21.21" connector inserts.
- 7 Kit of 6 self-tapping screws for plastics, for mounting of up to 3 "21.21" enclosures (not provided) on the adapter plate.
- 8 Locations for insertion of identification tags (size 9 x 20 mm).

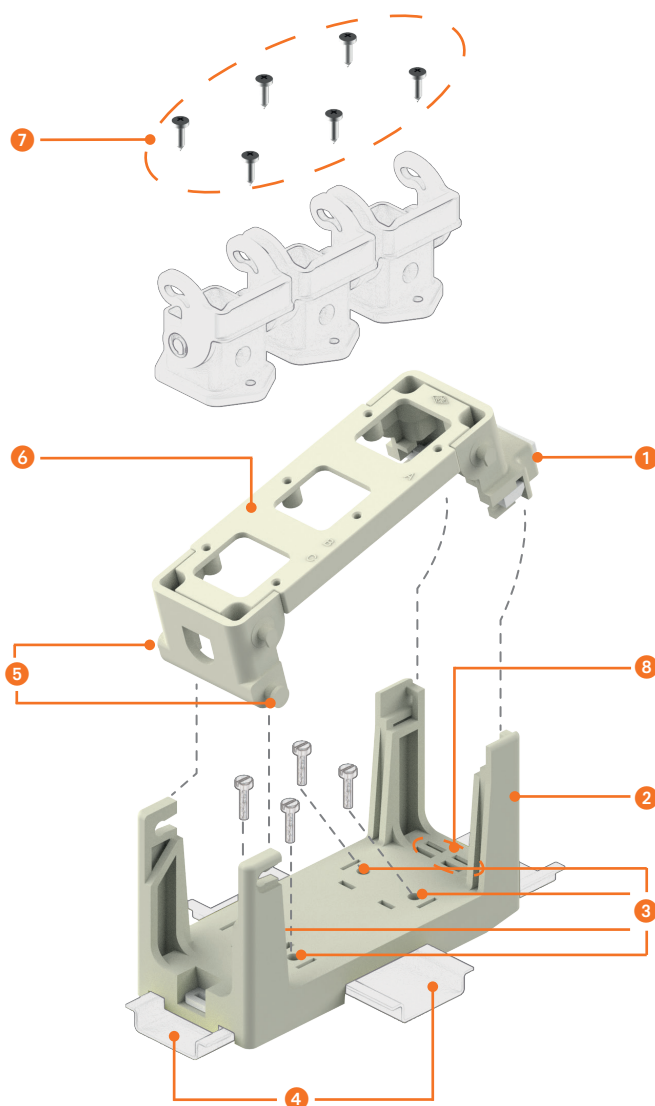



---

## T-BOX

### T-JUNCTION BOX FOR “21.21” INSERTS

---

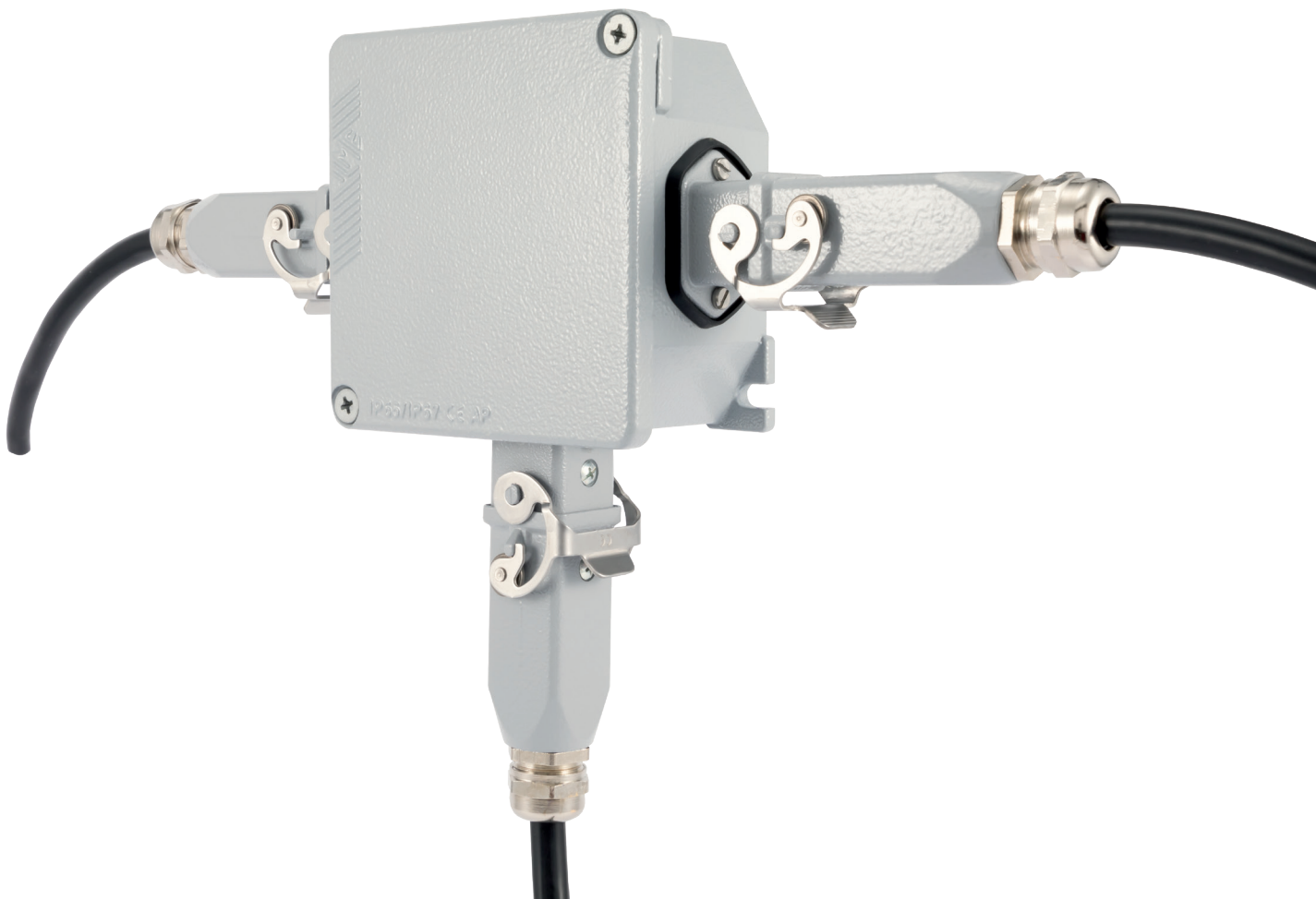

T-junction box for the assembly of daisy-chain power and control distribution, using the small-sized “21.21” connectors



Find more information on our products at [www.ilme.com](http://www.ilme.com)

## TECHNICAL FEATURES

### CYG 9KAXI3

This new **T-BOX** part no. **CYG 9KAXI3** special junction box provides a connectorized, compact T-junction for the assembly of typical daisy-chain power and control distribution, using the popular small-sized “21.21” connectors.

This new **T-BOX** special junction box is provided with three pre-assembled bulkhead mounting enclosures **CKAX 03 I**, with stainless steel “Class” locking levers with rolls, mounted over three suitably prepared sides of an **APV 9** IP66/IP67 junction box. Two facing connector enclosures serve the “IN-OUT” passing “bus” line (for power and/or signal) whereas the 90° connector enclosure serves the derivation line to the load.

This new **T-BOX** can house terminal blocks or twist-on wire connectors or cap terminals for easier wiring to the corresponding connectors.

Robust aluminium box and cover with formed-in-place PUR sealing gasket and epoxy-polyester coating.

Pre-assembled connector housings: 3x CKAX 03 I made by zinc alloy, with “Class” stainless steel locking lever.

Pass-through fixing screws and nuts on the flanges of the bulkhead mounting housings CKAX 03 I sealed to preserve the IP66/IP67 of the T-BOX CYG enclosure.

Zinc flake galvanized steel screws (two), M5x16, Ph2 for closing the cover, coupling torque 1 Nm (8,8 lb.in).

O-rings to make the cover screws captive, included.

Suitably sized diagonal DIN 60715 rail with fixing screws and inserts available as separate accessory (part no. **APD 9**).

PE connection terminals provided inside the box and under the metal cover; supplied with 2 brass inserts, 2 screws, 2 lugs and 2 washers for 6 mm<sup>2</sup> PE (protective earth) terminals.

The cover must always be connected to the PE (protective earth).

Two external wall fixing points (6 mm space for e.g. M5 screws) provided, diagonally placed on the box bottom.

Additional cover fastening wire, to anchor the cover to the box (temperature range: -40 °C ÷ +110 °C) available as separate accessory, part no. **APR F**.

Optional M4x8 threaded brass insert for simplifying the fitting of equipment and PCBs on the bottom of the box, part no. **APR 04** separately available.

Variants W-Type for aggressive environments (**CYGW 9KAXI3**) or S-Type “EMC” (**CYGS 9KAXI3**) available upon request.

IP66/IP67 degree of protection when inserts are equipped with CKR 65(D) kit of screwed gasket and coupled with suitably rated hoods.

robust aluminium  
box and cover with  
formed-in-place  
PUR sealing gasket  
and epoxy-polyester  
coating



# CYG box with T-junction for 21.21 inserts

inserts

Compatible with all power/signal  
"21.21" size inserts

T-junction box

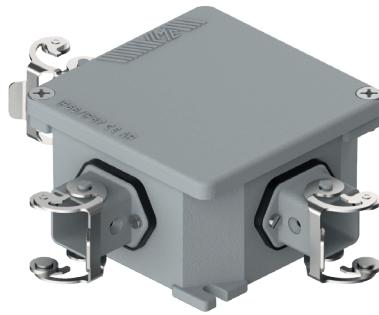

description

part No.

T-BOX with 3 CKAX 03 I housings pre-assembled

**CYG 9KAXI3**

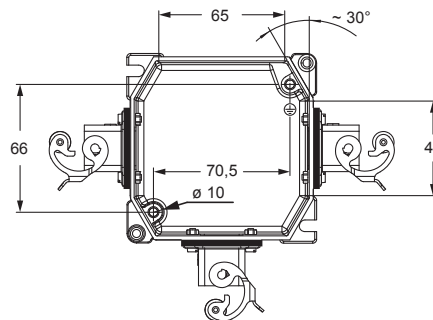

Top view without cover

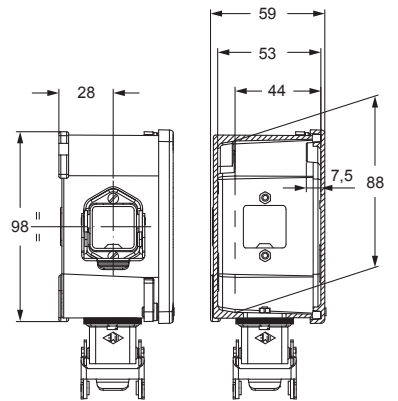
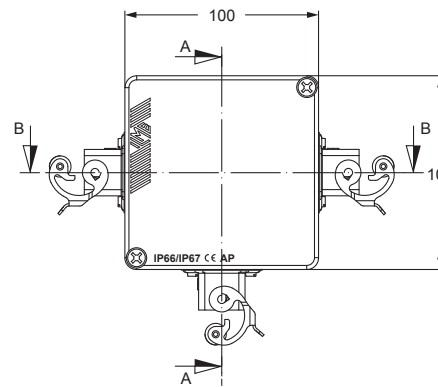
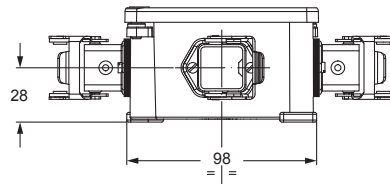

Sez. A-A

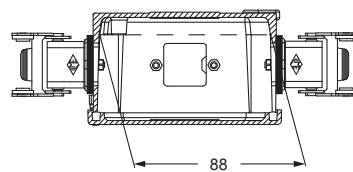

Sez. B-B

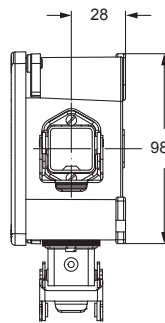
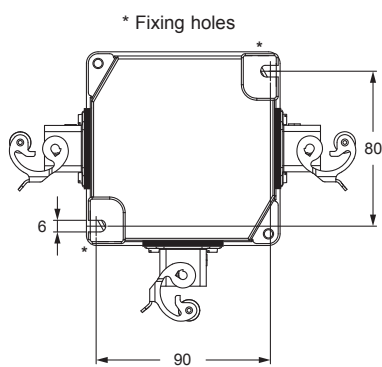

## T-JUNCTION BOX - EXAMPLE OF APPLICATION

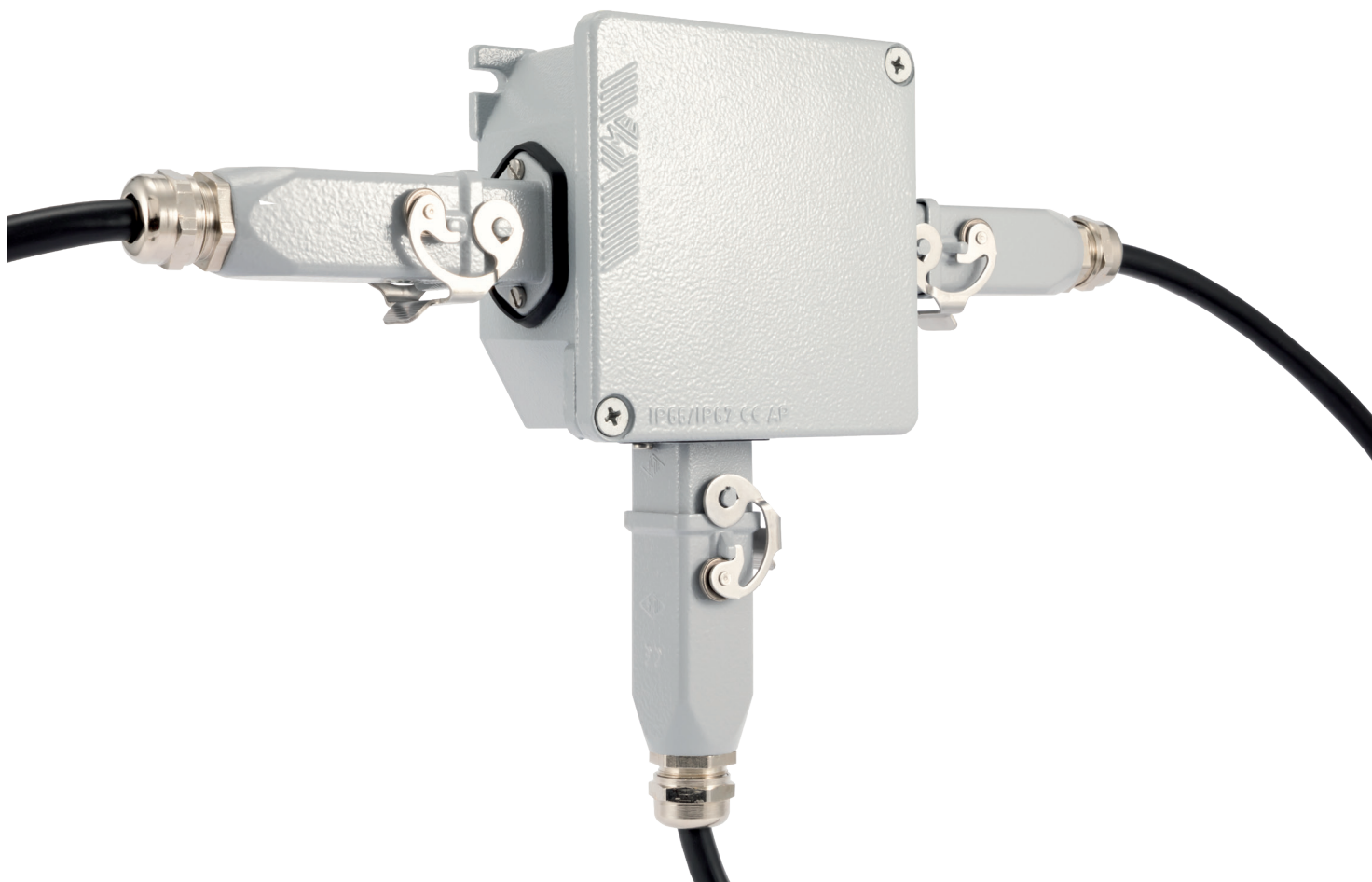



---

## CRIMPING TOOLS

---

### **Professional crimping hand tool SIPZ W, SIPZC W for SI stamped contact Series**

Easy handling tools designed both for loose and coils version of 5 A stamped crimp contacts. Application range from 0,08 mm<sup>2</sup> to 0,52 mm<sup>2</sup> (AWG 28-20). Contacts positioning with insulation stop.

### **CIPZP D Pneumatic crimping tool**

Pneumatic version of the CIPZ D tool for 5 A turned contacts. Crimping range from 0,08 mm<sup>2</sup> to 0,75 mm<sup>2</sup> (AWG 28-18) with CITP D locator for CI and RI contacts Series.

### **CCPZP RN Pneumatic crimping machine**

4/8 indent crimping unit with locator and digital readout display for CD / RD, CC / RC and CX / RX contact Series. The machine is operated by a pneumatic foot valve according to the same crimping adjustment of CCPZ RN manual tool (crimping depth and positioner seat).



Find more  
information on  
our products at  
[www.ilme.com](http://www.ilme.com)

# Tools and accessories for crimp contacts

for 5 A SI stamped contacts of inserts series

pages:

<b>CQ</b>	(21 poles)	<b>190</b>
<b>MIXO</b>	(25 poles)	<b>284</b>
<b>MIXO</b>	(36 poles)	<b>30 *</b>
<b>MIXO BUS</b>	(8 poles)	<b>293</b>
<b>MIXO D-SUB</b>	(9 poles)	<b>296</b>
<b>MIXO D-SUB</b>	(9 poles)	<b>70 *</b>

refer to CN.19 pages  
\* refer to NEWS 2020 pages

## manual crimping tool



## insertion / removal tool



description

part No.

part No.

manual crimping tool for **SI** contacts (for loose pcs.)  
WEZAG CS 10-D model

**SIPZ W**

extraction tool:

for the insertion and removal of the contacts into the inserts

- for **SI** contacts 0,08 - 0,52 mm<sup>2</sup>

(SIF..D / SIM..D Series)

**CIES**

**SIPZ W**

Front view

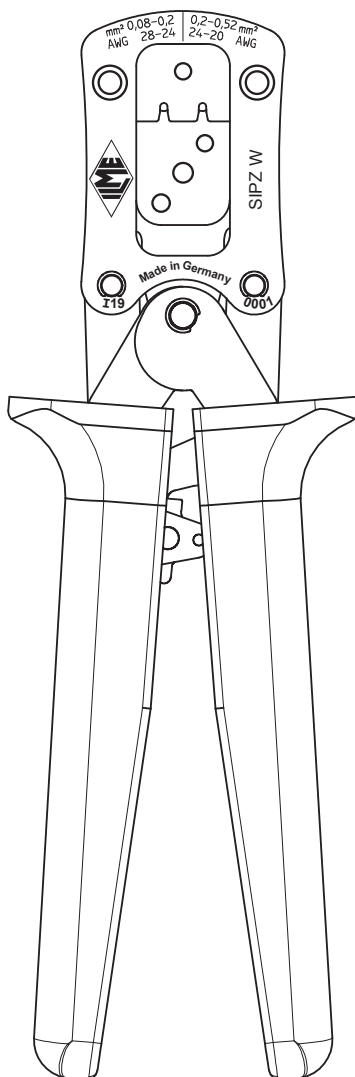

**Dimensions**

- Length: approx. 195 mm
- Width: approx. 63 mm
- Weight: approx. 290 g

**Application range**

Cross section range mm <sup>2</sup> / AWG	Crimp height ± 0,05	Crimp width ± 0,05	Contact Type
0,08-0,2 / 28-24	0,70	1,15	SI stamped
0,2-0,52 / 24-20	0,75	1,45	

# Tools and accessories for crimp contacts

for 5 A SI stamped contacts of inserts series

pages:

<b>CQ</b>	(21 poles)	<b>190</b>
<b>MIXO</b>	(25 poles)	<b>284</b>
<b>MIXO</b>	(36 poles)	<b>30 *</b>
<b>MIXO BUS</b>	(8 poles)	<b>293</b>
<b>MIXO D-SUB</b>	(9 poles)	<b>296</b>
<b>MIXO D-SUB</b>	(9 poles)	<b>70 *</b>

refer to CN.19 pages  
\* refer to NEWS 2020 pages

## manual crimping tool

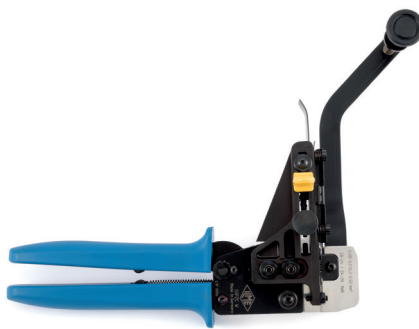

## insertion / removal tool



description

part No.

part No.

manual crimping tool for **SI** contacts (for coils)  
WEZAG CS 20 KTVR-D model

**SIPZC W**

extraction tool:  
for the insertion and removal of the contacts into the inserts  
- for **SI** contacts 0,08 - 0,52 mm<sup>2</sup>  
(SIF..D / SIM..D Series)

**CIES**

### SIPZC W Front view

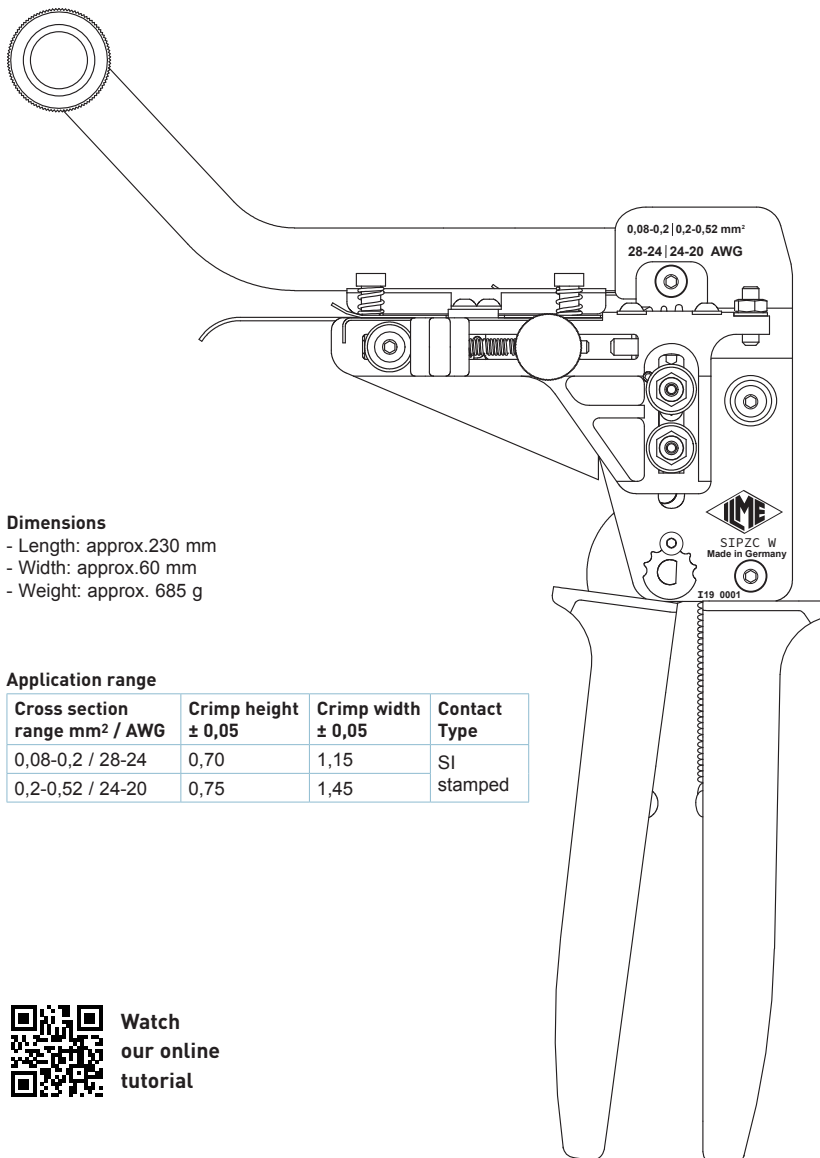

**Dimensions**  
- Length: approx.230 mm  
- Width: approx.60 mm  
- Weight: approx. 685 g

#### Application range

Cross section range mm <sup>2</sup> / AWG	Crimp height ± 0,05	Crimp width ± 0,05	Contact Type
0,08-0,2 / 28-24	0,70	1,15	SI
0,2-0,52 / 24-20	0,75	1,45	stamped



Watch our online tutorial



# Tools and accessories for crimp contacts

for 5 A CI and RI turned contacts of inserts series (as applicable)

pages:

CQ	(21 poles)	190
MIXO	(25 poles)	284
MIXO	(36 poles)	30 *
MIXO BUS	(8 poles)	293
MIXO D-SUB	(9 poles)	296
MIXO D-SUB	(9 poles)	70 *
GIGABIT	(8 poles)	286
GIGABIT HNM	(8 poles)	54 *
MEGABIT	(8 poles)	44 *
MEGABIT HNM	(8 poles)	46 *
SHIELDED	(20 poles)	36 *
SHIELDED HNM	(20 poles)	38 *

refer to CN.19 pages

\* refer to NEWS 2020 pages

pneumatic crimping tool positioner - gauge



insertion tool - removal tools



description	part No.	part No.
pneumatic crimping tool for turned 5 A contacts model DANIELS WA22 equivalent to CIPZ D (turret excluded)	CIPZP D	
positioner (DANIELS K1450I) for 5 A contacts (CIFA - CIMA; CIFD - CIMD; CIF2D - CIM2D; CIFJD - CIMJD; RIFD - RIMD Series)	CITP D	
bench support for CIPZP D pneumatic crimping tool (DANIELS BM-2A)	CCSPZP	
pneumatic foot valve (DANIELS WA10A)	CCVPP	
"go / no go" control gauge to verify indenter closure (See notes below)	CCPNP	
insertion and extraction tool: for the insertion and removal of the contacts into the inserts - for CI and RI contacts 0,2 - 0,5 mm <sup>2</sup> (CIFA - CIMA; CIFD - CIMD; CIF2D - CIM2D; CIFJD - CIMJD; RIFD - RIMD Series)		CIES
- for CI and RI contacts 0,75 mm <sup>2</sup> (CIFA - CIMA; CIFD - CIMD; CIF2D - CIM2D; CIFJD - CIMJD; RIFD - RIMD Series)		CIES B

**Notes:**

**Positioner**

conforms to international standard MIL-C-22520/1 - An interchangeable and indispensable accessory of the CIPZP D crimping tool, it precisely positions the contact where crimping is performed.

**"go / no go" control gauge**

conforms with international standard MIL-C-22520/3 - A tool used to periodically check that the crimping tool meets standard requirements.

**CCPNP**

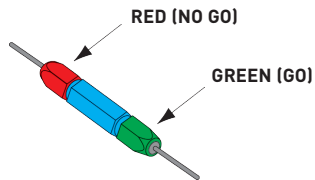

Gauge	tool selector pos. No.	Ø A ± 0,00254 mm (GO) green	Ø B ± 0,00254 mm (NO GO) red
CCPNP	8	0,991 (mm) 0,0390 (in)	1,118 (mm) 0,0440 (in)

**CITP D positioner**

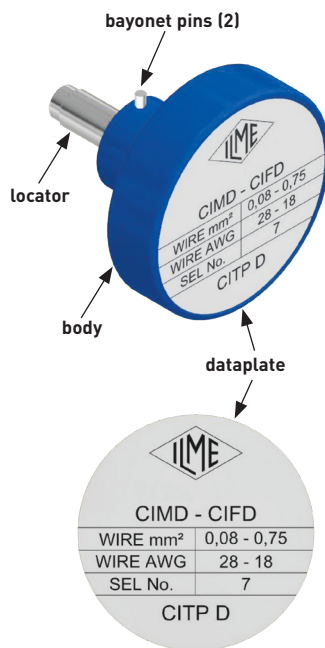

# Tools and accessories for crimp contacts

for 10 A, 16 A and 40 A contacts of inserts series (as applicable)

pages:

CD	(10 A)	66 - 74
CDD	(10 A)	76 - 83
CDC	(16 A)	104 - 106
CCE	(16 A)	130 - 135
CQE	(16 A)	168 - 173
CQEE	(16 A)	176 - 177
CMCE	(16 A)	137 - 145
CQ	(10 A/16 A)	186 - 193
CX 8/24	(16 A/10 A)	194
CX 6/36	(40 A/10 A)	198
CX 12/2	(40 A/10 A)	199
CX 6/6 **	(16 A)	206
CX 9/42	(40 A/10 A)	20 *
RD (HNM)	(10 A)	208 - 209
RDD (HNM)	(10 A)	210 - 213
RCE (HNM)	(16 A)	214 - 217
RQEE (HNM)	(16 A)	218 - 219
MIXO	(40 A/16 A/10 A)	267 - 306

\*\* the underlined polarities indicate those contacts that require the tools shown in this page

refer to CN.19 pages

\* refer to NEWS 2020 pages

## pneumatic crimping tool



## insertion tool - removal tools replacement tip



CCPR RN

description

part No.

part No.

pneumatic crimping tool for 10 A, 16 A and 40 A contacts (standard version series CD, CC, CX and "HNM" version series RD, RC and RX) RENNSTEIG CM 25-3 model. Locator and pedal footswitch included

CCPZP RN

insertion tool

for insertion of the contacts into the inserts for crimped contacts up to 0,75 mm<sup>2</sup>

CCINA

removal tools

for the extraction of contacts from the inserts

for 10 A contacts (CD, RD) <sup>1)</sup>

for 16 A contacts (CC, RC) <sup>2)</sup>

for 40 A contacts (CX, RX) <sup>3)</sup> and cables Ø < 5 mm

for 40 A contacts (CX, RX) <sup>4)</sup> and cables Ø < 7,5 mm

CCES  
CQES  
CXES  
CXES-10

replacement tip

for CCES removal tool

CCPR RN

<sup>1)</sup> for CQ, CD, CDD, CX, RX inserts (10 A auxiliary contacts) and MIXO module (10 A)

<sup>2)</sup> for CQ, CQE, CQEE, CCE, RCE, CMCE inserts (excluded 16+2), MIXO module (16 A), CX 6/6 (16 A) and CDC. For CMCE (16+2), CX inserts (contacts 16A insert CX 8/24) using a flat 3 mm screwdriver.

<sup>3)</sup> for CX, RX inserts (40A contacts) and MIXO module (40 A)

<sup>4)</sup> for MIXO module CX 03 4B and contacts 10 mm<sup>2</sup>.

### Tool technical information

- Crimping force 25 kN
- Operating pressure 6 bar
- Air requirement 0,75 l per working stroke
- Size (l x h x w): 325 x 500 x 280
- Weight: 30,5 kg

### Indenter technical information

- For crimping turned male and female contacts according to MIL/SAE AS22520
- Indent settings in 0,01 mm increments, with digital setting and readout
- Electronic wear monitoring with warning function
- Setting functions in mm and inch



Digital indenter with incorporated positioner

### "go / no go" control gauge

- A tool used to periodically check that the crimping tool meets standard requirements.

CCPNP RN

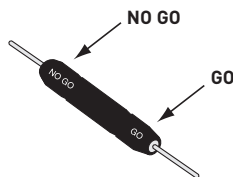

Gauge	tool selector pos. No.	Ø A GO	Ø B NO GO
CCPNP RN	2,00 (mm)	1,94 (mm)	2,06 (mm)

### Tool adjustment

The reference matrix on the crimping tool indicates the correct seat of the positioner (POS M1, F2, M3, F4, M5, F6) to select, and the crimping depth (SET) to adjust for the contact to be crimped.

#### Positioner seat = M1 (male) - F2 (female)

CDMA/D - RDM2D (male)	Section (mm <sup>2</sup> )	Crimp depth (mm)
CDFA/D - RDF2D (female)	0,14	1,3
	0,25	
	0,37	
	0,5	1,55
	0,7	1,55
	1,0	1,55
	1,5	1,55
	2,5	1,55

#### Positioner seat = M3 (male) - F4 (female)

CCMA/D - RCM2D (male)	Section (mm <sup>2</sup> )	Crimp depth (mm)
CCFA/D - RCF2D (female)	0,14	1,2
	0,25-0,37	1,3
	0,5	1,55
	0,7	1,55
	1,0	1,55
	1,5	1,8
	2,5	1,8
	3,0	1,9
	4,0	2,0

#### Positioner seat = M5 (male) - F6 (female)

CXMA/D - RXM2D (male)	Section (mm <sup>2</sup> )	Crimp depth (mm)
CXFA/D - RXF2D (female)	1,5	1,55
	2,5	1,8
	4,0	2,0
	6,0	2,5
	10,0	2,3

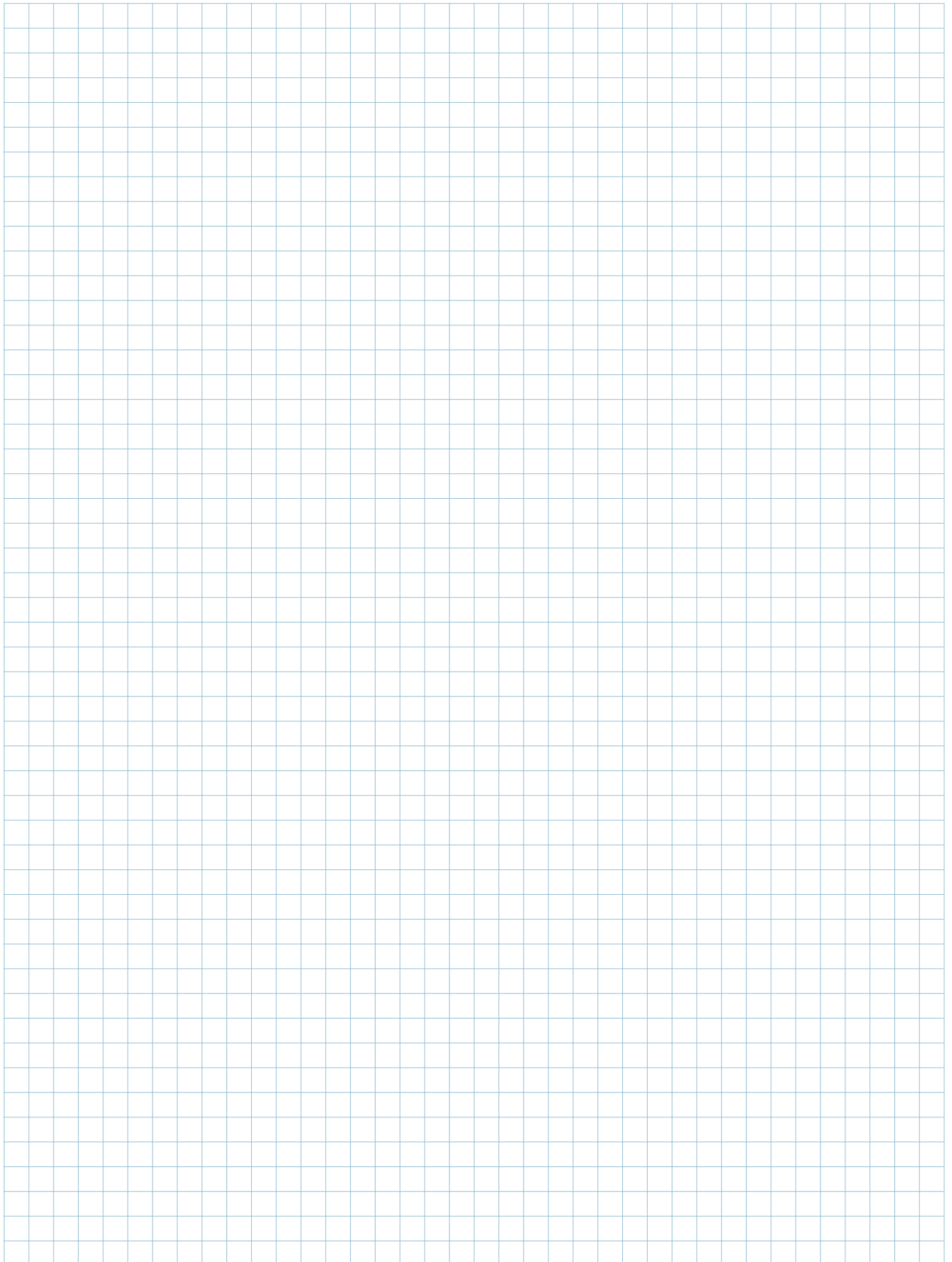



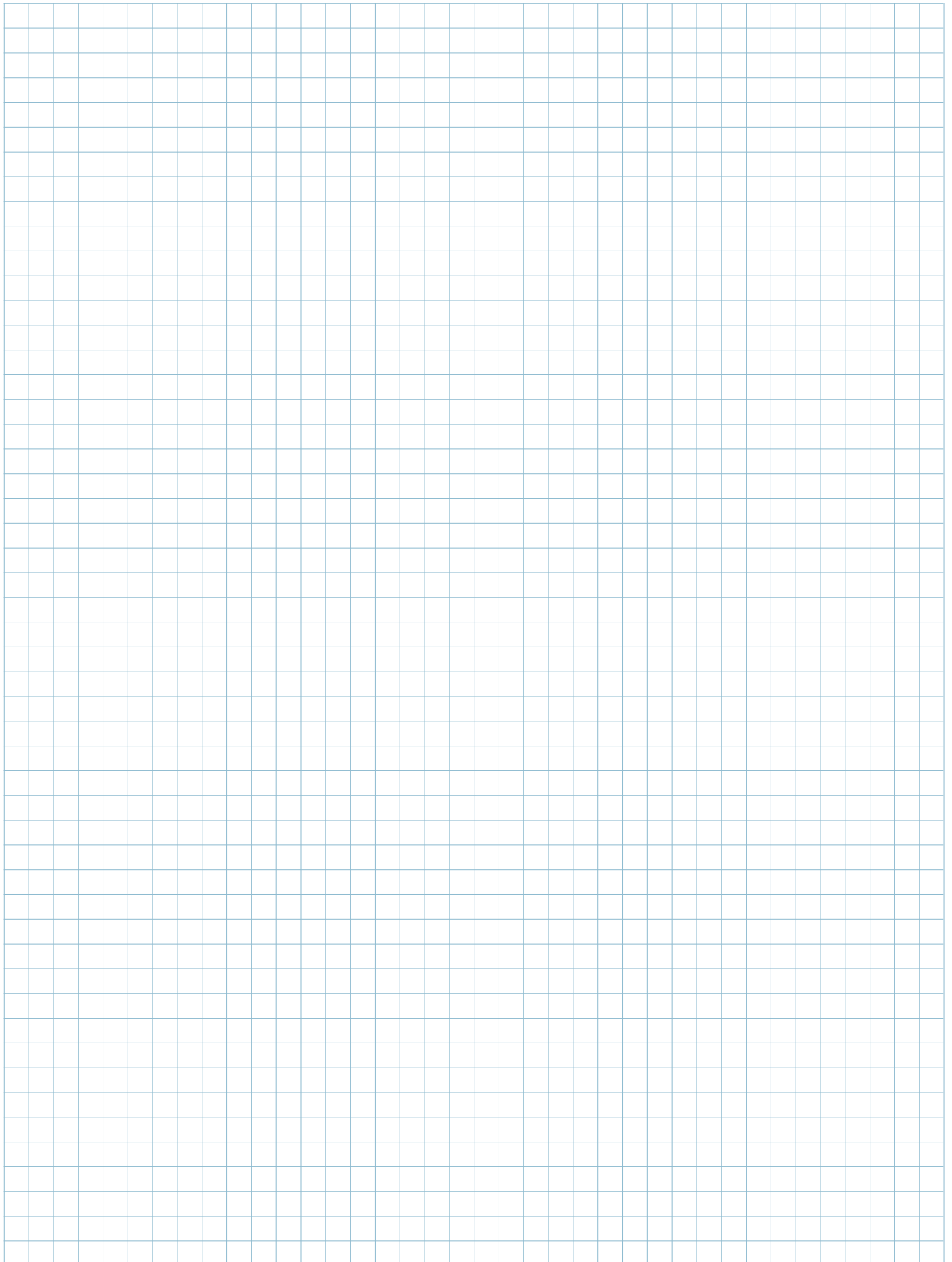

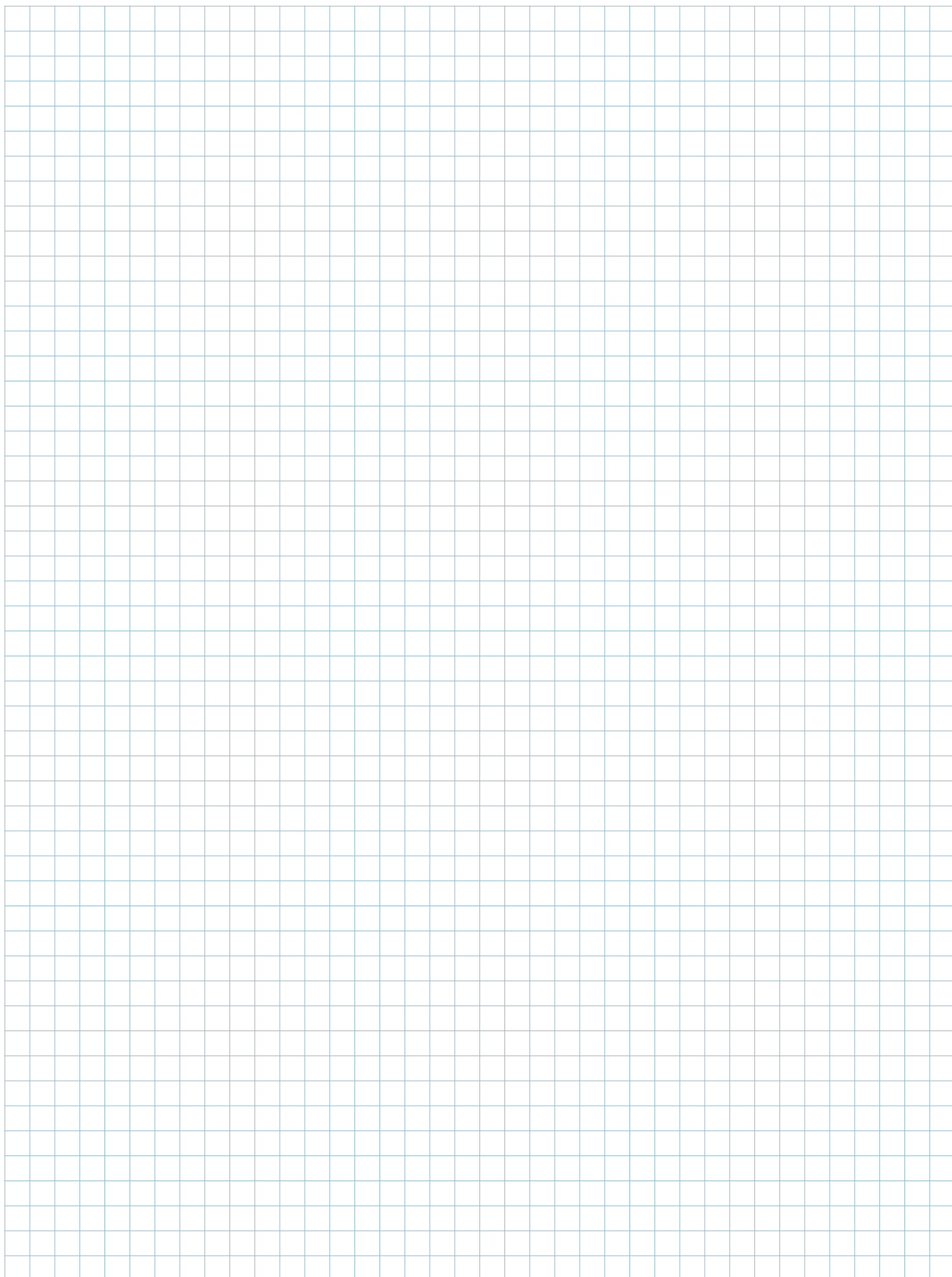

Visit **ilme.com** website to discover all the main features:



**Technical datasheets**  
to get all the information about our products.



**Application pages**  
to focus on installation locations, field requirements and technical details.



**Download Area**  
to find all the useful files in a click.



Get into our **Configurator** to easily find the right solution that fits your needs



search

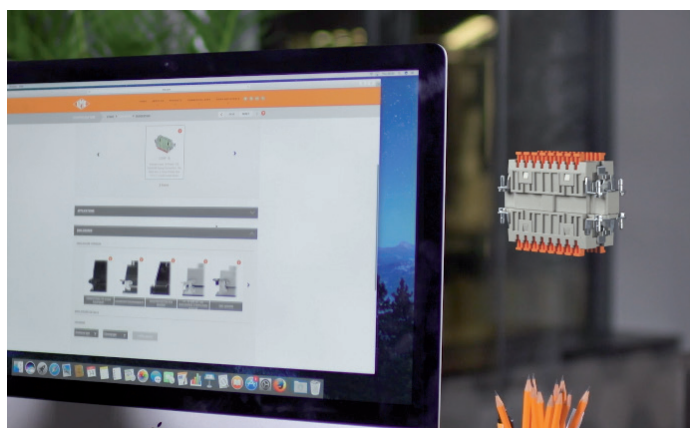

Over **50 million** connector combinations.

choose

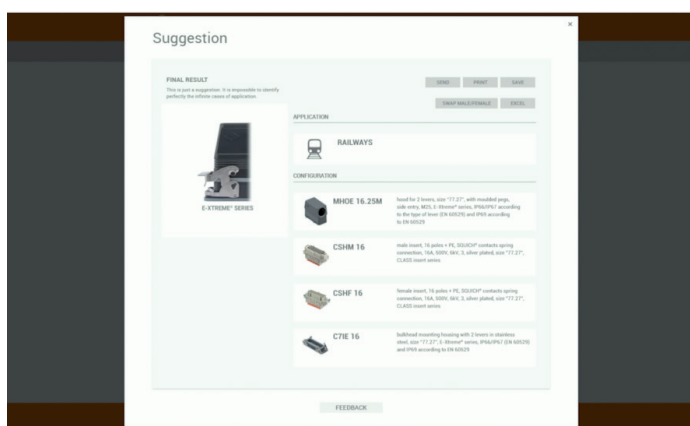

Easy selection of individual parts for key applications and recommendations for custom environmental conditions.

download



Smart suggestion to get the most suitable configuration.



## C

CAOX 50 X29.....	127	CIES B .....	144	CR 21.21 GMH.....	114
CAVX 50 G29.....	127	CIF2D 0.2.....	74	CR BDSH3A.....	102
CAVX 50 X29 .....	127	CIF2D 0.3.....	74	CR BDSH3G .....	103
CCES .....	145	CIF2D 0.5.....	74	CR BDSH6A.....	102
CCFFA .....	98	CIF2D 0.7 .....	74	CR BDSH6G .....	103
CCINA .....	145	CIFA 0.2 .....	30	CR BDSH9A.....	102
CCMFA.....	98	CIFA 0.3 .....	30	CR BDSH9G .....	103
CCPNP.....	144	CIFA 0.5 .....	30	CR BDSH14A.....	102
CCPR RN .....	145	CIFD 0.2 .....	30*	CR BDSH14G .....	103
CCPZP RN .....	145	CIFD 0.3 .....	30*	CR Q03/2.....	17
CCSPZP.....	144	CIFD 0.5 .....	30*	CW 2 MIAF.....	58
CCVPP .....	144	CIFJD 0.2 .....	74	CW 2 MIAM.....	58
CDFA 0.3.....	16*	CIFJD 0.3.....	74	CX 01 9VF2.....	70
CDFA 0.5.....	16*	CIFJD 0.5.....	74	CX 01 9VM2 .....	70
CDFA 0.7.....	16*	CIFJD 0.7 .....	74	CX 01 J8AIF.....	62
CDFA 1.0.....	16*	CIF Q05 2.4.....	98	CX 01 J8BIF.....	62
CDFA 1.5.....	16*	CIF Q07 2.4.....	94	CX 01 J8PIF .....	62
CDFA 2.5.....	16*	CIF Q12 2.4.....	90	CX 01 MIF .....	58
CDFA 6A28 .....	90*	CIM2D 0.2 .....	74	CX 01 MIM.....	58
CDFD 0.3.....	20*	CIM2D 0.3 .....	74	CX 02 4HF.....	66
CDFD 0.5.....	20*	CIM2D 0.5 .....	74	CX 02 4HM.....	66
CDFD 0.7.....	20*	CIM2D 0.7 .....	74	CX 5/7 CA .....	36*
CDFD 1.0.....	20*	CIMA 0.2 .....	30	CX 7/10 CA .....	36*
CDFD 1.5.....	20*	CIMA 0.3 .....	30	CX7FA 6.0.....	86
CDFD 2.5.....	20*	CIMA 0.5 .....	30	CX7MA 6.0.....	86
CDMA 0.3.....	16*	CIMD 0.2 .....	30*	CX 08 D5F.....	44
CDMA 0.5.....	16*	CIMD 0.3 .....	30*	CX 08 D5F2.....	44
CDMA 0.7 .....	16*	CIMD 0.5 .....	30*	CX 08 D5M.....	44
CDMA 1.0.....	16*	CIMJD 0.2 .....	74	CX 08 D5M2.....	44
CDMA 1.5.....	16*	CIMJD 0.3 .....	74	CX 10/12 CA .....	36*
CDMA 2.5.....	16*	CIMJD 0.5 .....	74	CX 20S IF.....	36
CDMA 6A .....	90*	CIMJD 0.7 .....	74	CX 20S IM .....	36
CDMD 0.3.....	20*	CIPZP D .....	144	CX 36 IF .....	30*
CDMD 0.5.....	20*	CITP D .....	144	CX 36 IM.....	30*
CDMD 0.7.....	20*	CKH 03 C.....	109	CXES .....	145
CDMD 1.0.....	20*	CKH 03 CA.....	109	CXES-10.....	145
CDMD 1.5.....	20*	CKH 03 CAS.....	109	CXF 9/42 .....	20
CDMD 2.5.....	20*	CKH 03 CS.....	109	CXFA 1.5 .....	16*
CHCX 50 G.....	128	CKH 03 CX.....	109	CXFA 2.5 .....	16*
CHCXW 50 G .....	131	CKH 03 CXA .....	109	CXFA 4.0 .....	16*
CHES .....	66	CKH 03 I.....	108	CXFA 6.0 .....	16*
CHIX 50.....	126	CKH 03 IA .....	108	CXFA 10 .....	66
CHIXW 50.....	130	CKRH 65.....	114	CXM 9/42.....	20
CHOX 50 X.....	127	CKRH 65 D.....	114	CXMA 1.5 .....	16*
CHPX 50.21.....	126	COB 03/3 BC .....	134	CXMA 2.5 .....	16*
CHPX 50.29.....	126	CQ4F 03/2.....	16	CXMA 4.0 .....	16*
CHPXW 50.21 .....	130	CQ4M 03/2.....	16	CXMA 6.0 .....	16*
CIES .....	142*	CQES .....	145	CXMA 10 .....	66
		CQF 12 CIF.....	90	CYG 9KAXI3.....	138
		CQM 12 CIF .....	90		

\* These items are also shown in various sections throughout the catalogue

## M

MAOX 50 X32 .....	127
MAVX 50 G32.....	127
MAVX 50 X32.....	127
MBV 24.40D.....	120
MBV 24.40DG.....	120
MBV 24.240D.....	121
MBV 24.240DG.....	121
MFOX 50 X32.....	127
MFVX 50 X32.....	127
MHOX 50 X32.....	127
MHPX 50.32.....	126
MHPXW 50.32.....	130
MKGH V20.....	112
MKGH V25.....	113
MKGH VA20.....	112
MKH IAP20.....	108
MKH V20.....	109
MKH V25.....	110
MKH VA20.....	109
MKH VG20.....	109
MKH VG25.....	111

## R

RDF2D 0.3.....	47
RDF2D 0.5.....	47
RDF2D 0.7.....	47
RDF2D 1.0.....	47
RDF2D 1.5.....	47
RDF2D 2.5.....	47
RDM2D 0.3.....	47
RDM2D 0.5.....	47
RDM2D 0.7.....	47
RDM2D 1.0.....	47
RDM2D 1.5.....	47
RDM2D 2.5.....	47
RIFD 0.2.....	32*
RIFD 0.3.....	32*
RIFD 0.5.....	32*
RIFD 0.7.....	82
RIMD 0.2.....	32*
RIMD 0.3.....	32*
RIMD 0.5.....	32*
RIMD 0.7.....	82
RX 02 TF.....	33*
RX 02 TM.....	33*
RX 03 TF.....	33*

RX 03 TM.....	33*
RX 04 TF.....	33*
RX 04 TM.....	33*
RX 06 TF.....	33*
RX 06 TM.....	33*
RX 08 D5F.....	46
RX 08 D5F2.....	46
RX 08 D5M.....	46
RX 08 D5M2.....	46
RX 08 I6F.....	54
RX 08 I6M.....	54
RX 20S IF.....	38
RX 20S IM.....	38

## S

SIF1D 0.2.....	78
SIF1D 0.2C.....	78
SIF1D 0.2R.....	78
SIF1D 0.5.....	79
SIF1D 0.5C.....	79
SIF1D 0.5R.....	79
SIF2D 0.2.....	78
SIF2D 0.2C.....	78
SIF2D 0.2R.....	78
SIF2D 0.5.....	79
SIF2D 0.5C.....	79
SIF2D 0.5R.....	79
SIF3D 0.2.....	78
SIF3D 0.2C.....	78
SIF3D 0.2R.....	78
SIF3D 0.5.....	79
SIF3D 0.5C.....	79
SIF3D 0.5R.....	79
SIM1D 0.2.....	78
SIM1D 0.2C.....	78
SIM1D 0.2R.....	78
SIM1D 0.5.....	79
SIM1D 0.5C.....	79
SIM1D 0.5R.....	79
SIM2D 0.2.....	78
SIM2D 0.2C.....	78
SIM2D 0.2R.....	78
SIM2D 0.5.....	79
SIM2D 0.5C.....	79
SIM2D 0.5R.....	79
SIM3D 0.2.....	78
SIM3D 0.2C.....	78
SIM3D 0.2R.....	78

SIM3D 0.5.....	79
SIM3D 0.5C.....	79
SIM3D 0.5R.....	79
SIPZC W.....	143
SIPZ W.....	142

\* These items are also shown in various sections throughout the catalogue

# Worldwide Sales Organization

## Headquarters

### ILME S.p.A.

Via M.A. Colonna, 9  
20149 Milano, Italia  
T +39 0234560522  
info@ilme.com

## France

### ILME FRANCE S.A.R.L.

431 rue Roland Garros  
Parc d'Activités de l'Aéroport  
42160 Andrézieux-Bouthéon  
T +33 04 7736 2336  
ilme-france@ilme.fr

## Sweden

### and Nordic Countries

### ILME NORDIC AB

Transportvägen 18  
246 42 Löddeköpinge  
T +46 4618 2800  
info@ilme.se

## Czech Republic

### Representative Office

### ILME S.p.A.

Business Center Rokytká  
Sokolovská 270/201  
Vysocany, Praha 9, 190 00  
info@ilme.cz

## Japan

### ILME JAPAN CO. LTD.

K.I.B.C. Bldg 5-2  
Minatojima Minamimachi 5-Chome  
Chuo-Ku, Kobe 650-0047  
T +81 78 302 2005  
info@ilmejapan.co.jp

## Germany

### ILME GmbH

Max-Planck-Straße 12  
51674 Wiehl  
T +49 (0)2261 7955 0  
technik@ilme.de

## United Kingdom

### ILME UK LIMITED

50 Evans Road, Venture Point  
Speke, Liverpool L24 9PB  
T +44 0151 336 9321  
sales@ilmeuk.co.uk

## China

### ILME CHINA CO. LTD.

Room 101, Building 3  
188 Xinjunhuan Road, Minhang  
Shanghai 201114  
T +86 21 6248 9961  
info@ilmechina.com

## South Korea

### ILME KOREA CO.

714, DaeRyung Technotown 20<sup>th</sup>  
5 Gasan Digital 1-Ro, GeumCheon-Gu  
Seoul 08594  
T +82-2-2225-8432  
sales@ilme.kr

[www.ilme.com](http://www.ilme.com)





**ILME S.p.A.**  
Via M.A. Colonna 9  
20149 Milano, Italy  
[www.ilme.com](http://www.ilme.com)

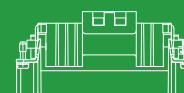
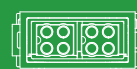
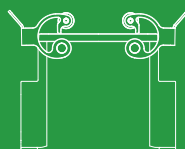
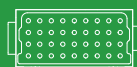
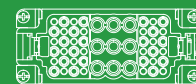
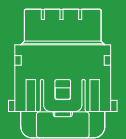
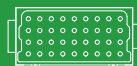
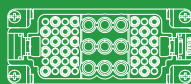
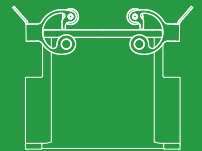
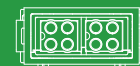
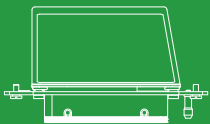
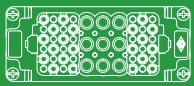
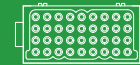
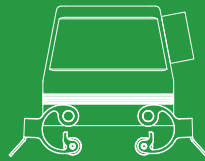
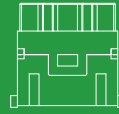
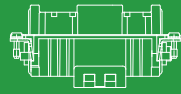
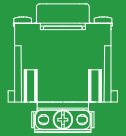
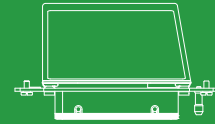

XDGPDT20 223



catalogues