



Multipole connectors

20

23

DISCLAIMER

The information provided in this Catalogue is valid at the date of publication.
Updated information may be available online at <https://www.ilme.com>:

- Q checking the relevant section of ILME website for latest release of this Catalogue;
 - Q consulting the specific online product data sheet;
 - Q checking the latest Certifications available for download.
-



THE TRADITION OF INNOVATION SINCE 1945

ILME designs and manufactures complete solutions for industrial connections.

Headquartered in Milan and with subsidiaries in the key countries driving the progress of automation, ILME is an industry leader in the main world markets.

People are vital to success and growth at ILME, sharing a passion for innovation, utmost responsibility and participation.

The Company is committed to developing technology in the areas that most impact the future of the industries it serves: original solutions and safe wiring, research on the most suitable materials, rapid turnaround and readily available services while striving for energy saving and environmental safeguard.

COMMITMENT TO INDUSTRY

Technological innovation is the main pillar of ILME competitiveness.

In the electrical connection sector of industrial automation, characterized by the need for top performance and reliability, ILME is an acknowledged leader with its own patents, and a global benchmark supplier of major companies worldwide.

ILME offers a fully integrated range of high-quality products and services for every type of connection to suit any application requirements.



AUTOMATION



RAILWAY



ENERGY



MARINE



FOOD
& BEVERAGE



AGRONOMY



OUTDOOR



HEAVY VEHICLES



LIGHT
& SOUND



PLASTICS



CHEMICAL



AIRPORT

IMPORTANT NOTES

- 1 ILME designs and manufactures complete solutions for Heavy Duty electrical power connections.
The connector (although offered to the user as a variety of elements, usually inserts and enclosures, to allow the selection of the ideal combination) has been **designed as a complete connector** and tested to be compliant with the essential safety requirements of the EU Low Voltage Directive 2014/35/EU and in particular the EN 61984 standard. The design of this “whole” system guarantees that every allowed combination of inserts, enclosures and accessories cannot result as improper.

- 2 The products in this catalogue alone cannot guarantee the best functionality upon installation, as this depends also on their correct **“putting into service”** which must be performed in compliance with the applicable system safety standards and according to the “rule of the art”. Therefore the effectiveness of the installation of the connector depends on the choices of the end user who must also take into account the following safety requirements.

- 3 Connectors must **not be connected or disconnected when live or under load**.

- 4 After wiring the inserts it is necessary to **verify the continuity of the protective earth connections**.

- 5 The **correct coupling of the inserts** is guaranteed only if they are installed (with the four fixing screws supplied *) inside the corresponding enclosures or onto compatible accessories in this catalogue. ILME S.p.A. is not responsible for any different application.

- 6 Wiring of **screw-type terminal connections** must be carried out applying the correct tightening torque in order to avoid false contacts or damage to the conductor, the screw or the terminal.

- 7 **Crimping tools** and **crimp contacts** used should preferably be supplied by the same manufacturer to avoid difficulties with the insertion and retention or damaging of the contacts themselves.

- 8 Correct wiring of **spring-clamp connection inserts** is guaranteed only when the correct screwdriver indicated in the specific catalogue, or possibly on the insert, is used **.

- 9 Avoid forcing the contacts during **connection and disconnection**. Connectors must be coupled and uncoupled in the axial direction with respect to the contacts, without bending and pulling the attached conductor bundles or cables.

- 10 Installation of two **inserts side by side**, in enclosures with two bays, must respect the polarity drawing marked on the insert (or the contact side view, as shown in this catalogue) to avoid inverted coupling.

- 11 Installation of two or more identical **connectors side by side** is recommended only with the use of **coding pins** in order to avoid mismatched couplings.

- 12 In order to keep the declared **degree of protection** (IP code according to EN 60529, or Enclosure Type Rating according to ANSI/UL 50E), enclosures must be completed with cable glands and/or other accessories with at least an equal degree of protection.

- 13 Moreover, the declared **degree of protection** (IP code according to EN 60529, or Enclosure Type Rating according to ANSI/UL 50E) is guaranteed when the enclosures, complete with inserts, are coupled and locked with their locking levers (or devices).

- 14 Connector inserts and their enclosures are generally compatible with similar/equivalent products from other manufacturers, according to the last samples tested. Full compatibility cannot be guaranteed in the event of technical changes made by other manufacturers. In particular, maximum performance of IP68 enclosures (CG-MG, CGK-MGK Series) cannot be guaranteed when coupled with other manufacturers' products.

- 15 **Spare parts** are supplied in minimum quantities only with the purpose to replace damaged parts. To avoid invalidation of warranty, products should be modified or repaired only by ILME: the integrity of their functionality - e.g. their degree of protection - can no longer be guaranteed if products are modified/repared by end-users. In any case, the liability for correct choice, assembly and use is totally at charge of the installer and the end-user.

- 16 ILME S.p.A. takes no responsibility in verifying whether the components herein contained comply with any specific regulations of fields of application.

- 17 ILME cannot be held responsible for individual components in **uses other than those described in this catalogue**.
ILME cannot be held responsible for **incorrect connector selection** in relation to the environmental conditions of the application (e.g.: influence of ambient temperature, moisture, environmental pollution, etc.).

* Except one fixing screw for size “21.21” inserts, two fixing screws for size “32.13” inserts.

** Except for **SQUICH®** inserts (with spring-clamp terminals with actuator button) and **AXYR®** inserts (push-in spring terminals with actuator button) that do not require any tool to operate the terminal.

CE MARKING

As from 1st January 1997, in order to make available electrical products on the European market, the manufacturer must ensure that these bear the relevant **CE marking**, in line with the Low Voltage Directive 73/23/ EEC* (implemented in Italy as L. D. 18-10-1977 no. 791) and its modification 93/68/EEC* (implemented in Italy as L.D. 25-11-1996 no. 626/96, published in the supplement to the Gazzetta Ufficiale of 14-12-1996).

The CE marking must be visible on the product or, if this is not possible, on the packaging, the instructions for use or on the warranty certificate. It acts as a declaration by the manufacturer that the product complies with all relevant EU directives regarding its field of application.

ILME products bear the CE marking on the actual product or its packaging.

Almost all ILME products fall within the scope of the Low Voltage Directive. An EU declaration of conformity is required in order to be able to apply the CE marking. This declaration, to which the market is not directly entitled, must be made available to the controlling authorities (in Italy, the Ministry of Economic Development) at all times. In it, the manufacturer declares the technical safety standard(s) followed in the design and manufacture of the product. These standards must be, in decreasing order of preference:

- a European standard (EN prefix)
- a European harmonisation document (HD prefix)
- an IEC International Standard
- a national standard
- in the absence of reference safety standards, the manufacturer's internal specifications guaranteeing compliance with the basic safety requirements of the directive.

Conformity with harmonised technical standards (i.e. ratified by CENELEC) also constitutes presumption of conformity with the basic safety requirements of the directives.

The CE marking of ILME products results from the declaration of conformity of the product to harmonised standards or IEC International Standards.

Through the CE marking, ILME declares full compliance, not merely with the directive's basic safety requirements, but also with those international or national standards on which voluntary safety certification markings are based (e.g. IMQ and VDE). In this way, ILME intends to give the CE marking the value of self-certification in terms of safety, given the loss in legal value of voluntary certifications issued by third parties, ratified by directive 93/68/EEC*.

Notwithstanding the above, practically all ILME products still bear voluntary conformity markings.

The above mentioned EU declaration of conformity becomes null and void when the assembly of products includes one or more components not manufactured by ILME and without CE marking.

▲ The information contained in this catalogue is not binding and may be changed without notice.

* **Note:** The subsequent legal reference for the Low Voltage Directive was 2006/95/EC, as consolidation of the original Directive 73/23/EEC + Directive 93/68/EEC. On 29th March 2014, the Official Journal of the European Union published the new Low Voltage directive 2014/35/ EU dd. 26th February 2014, a recast version of directive 2006/95/EC, which is in force since 20th April 2016.



UNI EN ISO 9001: 2015
Design, manufacture and distribution
of industrial electrical equipment (IAF 19)
Certificate No. 50 100 11133



2023 PRODUCTS

AXYR® **12**

ZOOM-IN AND BENEFITS **13**

THE WIRING **14**

PRODUCT RANGE **15**



AXYR®
size "21.21"
7 poles + ⊕ inserts

16



AXYR®
size "21.21"
8 poles inserts

16

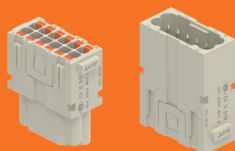

AXYR®
MIXO 12 poles modules

20

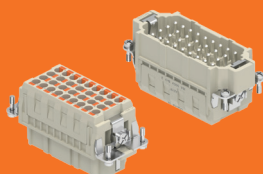

AXYR®
CQEY inserts series

22

MIXO modular units 30

MIXO NOVELTIES 30

GENERAL OVERVIEW 32

THE COMPLETE RANGE 34

TECHNICAL CHARACTERISTICS 36

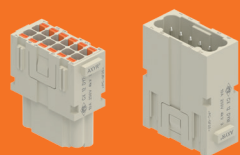

AXYR®
MIXO 12 poles modules

38

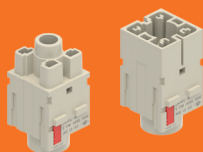

MIXO 300 A
1 pole modules

40

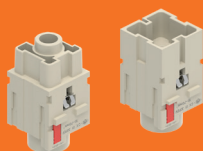

MIXO 300 A
1 PE pole modules

40



C30 crimp contacts series
sizes 16, 25, 35, 50, 70, 95, 120

43, 45

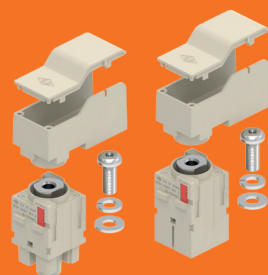

MIXO 300 A
90 °-angled 1 pole modules

48

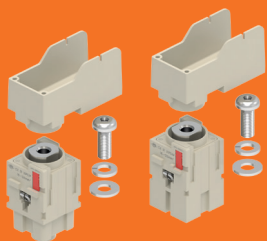

MIXO 300 A
90 °-angled 1 PE pole
modules

48



Crimping tools
for C30 series
crimp contacts

54-55

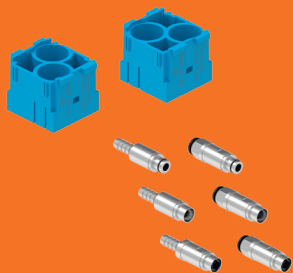

MIXO pneumatic
metal modules
and contacts

56

Inserts

60

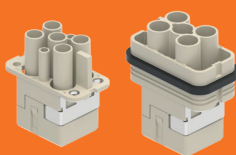

CQ size "32.13"
crimp inserts for
metal enclosures

60

Contacts

64

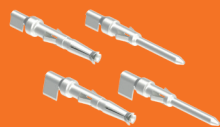

SD series 10 A stamped crimp contacts, sizes 1.0 and 2.5

64



Crimping tools for SD series 10 A stamped crimp contacts

67

Enclosures

68



Metallic hoods size "21.21" with M25 angled cable entry

68



MIXO TWO enclosures

72



Standard enclosures with IL-BRID single locking lever

80

Accessories

88



Covers for IP68 hoods
with screw locking

88

Part numbers index

92

AXYR®

HIGH-DENSITY, FAST & TOOL-LESS CONNECTIONS

The research of new termination technologies aims to develop a reliable and qualitatively stable connection between conductor and contact, meeting any possible application requirement in terms of current carrying-capacity and available number of poles, as much as possible independently from the skill of the operator.

Crimped connection, with its typical irreversible process, achieves the best performance and the highest possible connection density, but requires specific wiring procedures and special tools, while being also non-rewirable.

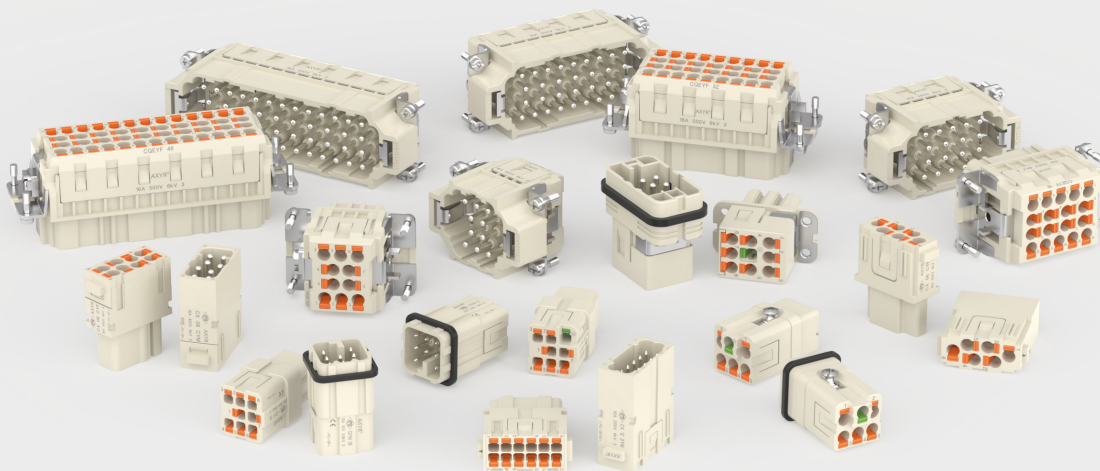

- Q **ILME AXYR® technology** offers an extremely compact **spring push-in** termination, which equals the crimp connectors in **high density**, but requires **no special crimping tool**, yet granting an optimal electrical performance. **An easy, tool-less and operator-skill-independent connection**, resistant to mechanical stress and vibrations, suitable for any installation requirement.
- Q **AXYR®** features a harmonic steel spring and a tiny, yet stiff, properly designed actuator button working together to allow a **simple push-in action** guaranteeing a safe wiring.
- Q Thanks to a **boxed terminal**, the wire contact pressure does not rely upon surrounding insulating parts, likely to possibly relax under heating when the connector is under current load.
- Q Solid and ferruled flexible wires, when sufficiently stiff, can be **directly inserted** into the connection terminal*; unprepared stranded wires require instead the initial opening of the spring by means of a simple flat-blade screwdriver, thanks to the actuator button.
- Q **AXYR®** technology makes the **user free to choose** the connector that best suits his needs, naturally reusable and **independent of the required wire cross-section**, compatible with the crimp connectors of the ILME product portfolio: **one size fits the whole range of cross-sectional areas** (compared to competing solution with radial spring that require two sizes).

* Cross-sectional area $\geq 0,75 \text{ mm}^2 / 18 \text{ AWG}$

AXYR® TECHNOLOGY

ZOOM-IN AND BENEFITS

- ▶ **AXYR®** connection equals the density of the crimp connection, without need for any crimping tool
- ▶ Wire release with a **simple** flat-blade screwdriver
- ▶ **Machined** brass contacts
- ▶ One size fits the **whole range** of cross-sectional areas
- ▶ Suitable for **rigid or ferrule-prepared** stranded wires **as well as** for unprepared stranded wires

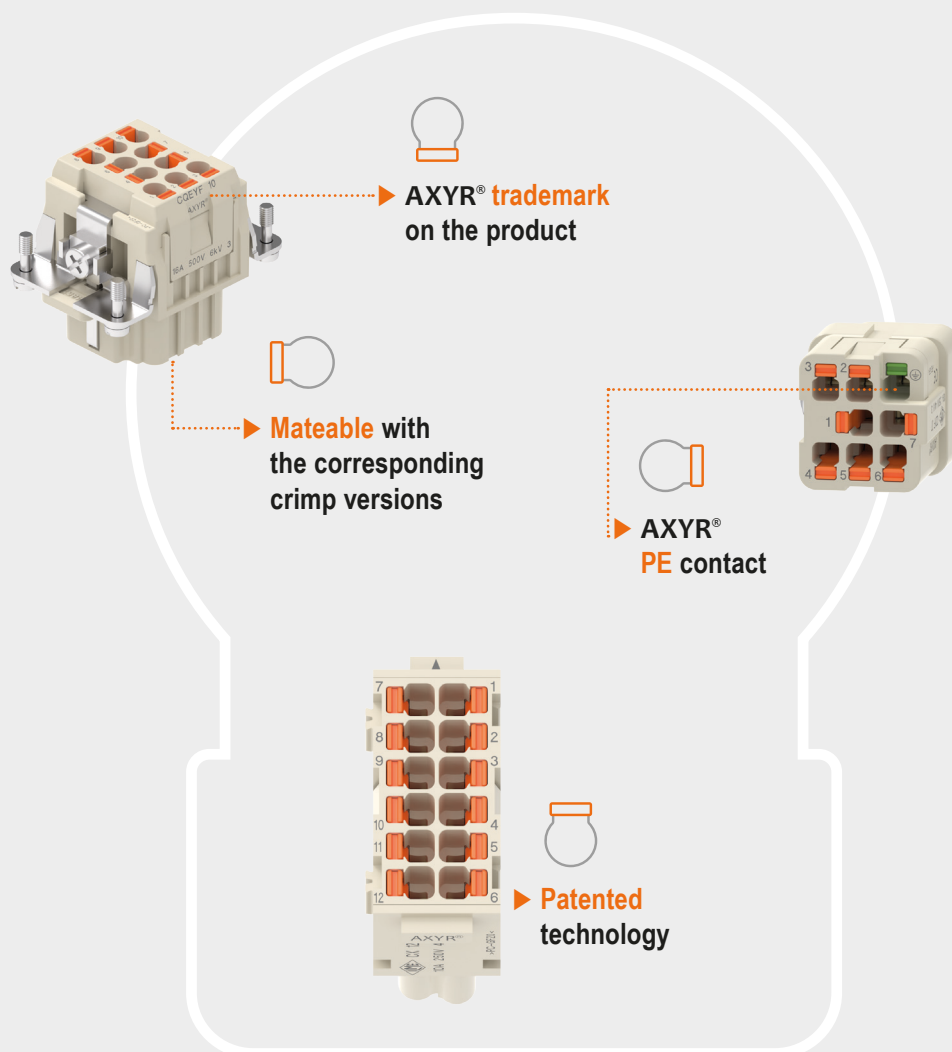

AXYR® FROM INSIDE

THE WIRING



Watch our
Technical Clip



**SOLID
OR FERRULED WIRE**
(CSA* \geq 0,75 mm² / 18 AWG)



STRANDED WIRE
(all CSA*)
SOLID OR FERRULED WIRE
(CSA* $<$ 0,75 mm² / 18 AWG)

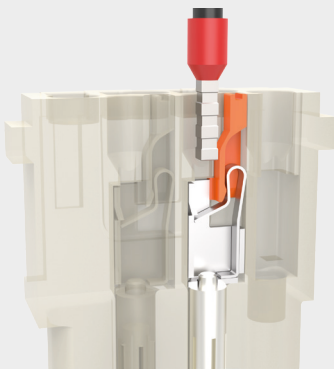

1

Deeply insert
the solid
or ferruled
wire into the
contact hole

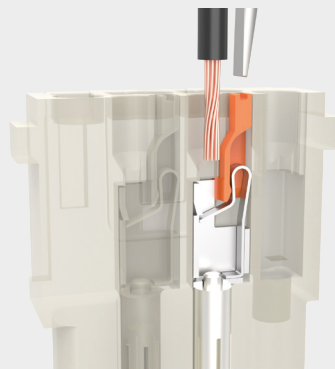

1

Push down the actuator button
by a flat-blade screwdriver
0,5 × 3 mm max. for **10 A**
0,5 × 3,5 mm max. for **16 A**
insert the stranded wire into
the contact hole

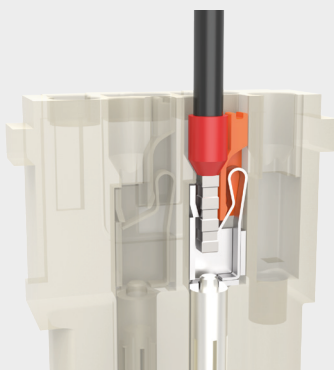

2

The wire is
safely secured
by the spring
clamp

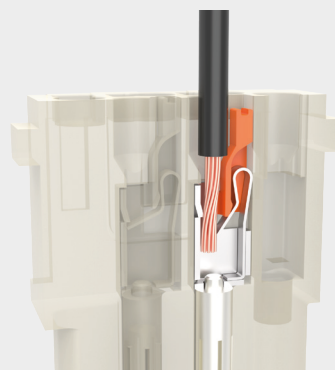

2

The wire is
safely secured
by the spring
clamp

Re-opening

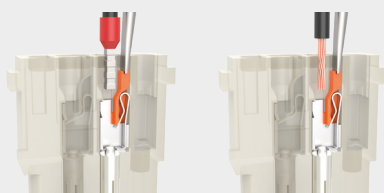

Push down the actuator button by a flat-blade
screwdriver to remove the wire:

0,5 × 3 mm max. for **10 A**
0,5 × 3,5 mm max. for **16 A**

*CSA = Cross-Sectional Area

AXYR®

PRODUCT RANGE



Watch our
Technical Clip

AXYR® 16 A and 10 A novelties are marked with the symbol **+**

Inserts		EN 61984 Rating	Poles	Series	Size
CX 06 CYF	CX 06 CYM	16 A 500 V 6 kV 3	6	MIXO	1 module
CX 08 CYF	CX 08 CYM	16 A 400 V 6 kV 3	8	MIXO	1 module
+ CX 12 DYF	+ CX 12 DYM	10 A 250 V 4 kV 3	12	MIXO	1 module
CQYF 05	CQYM 05	16 A 230/400 V 4 kV 3	5 + ⊖	CQY	"21.21"
+ CDYF 07	+ CDYM 07	10 A 250 V 4 kV 3	7 + ⊖	CDY	"21.21"
+ CDYF 08	+ CDYM 08	10 A 50 V_{AC}/120 V_{DC} 0,8 kV 3	8	CDY	"21.21"
CQYF 08E	CQYM 08E	16 A 500 V 6 kV 3	8 + ⊖	CQY	"32.13"
+ CQEYF 10	+ CQEYM 10	16 A 500 V 6 kV 3	10 + ⊖	CQEY	"44.27"
+ CQEYF 18	+ CQEYM 18	16 A 500 V 6 kV 3	18 + ⊖	CQEY	"57.27"
+ CQEYF 32 /N	+ CQEYM 32 /N	16 A 500 V 6 kV 3	32 + ⊖ / 64 + ⊖	CQEY	"77.27" / "77.62"
+ CQEYF 46 /N	+ CQEYM 46 /N	16 A 500 V 6 kV 3	46 + ⊖ / 92 + ⊖	CQEY	"104.27" / "104.62"

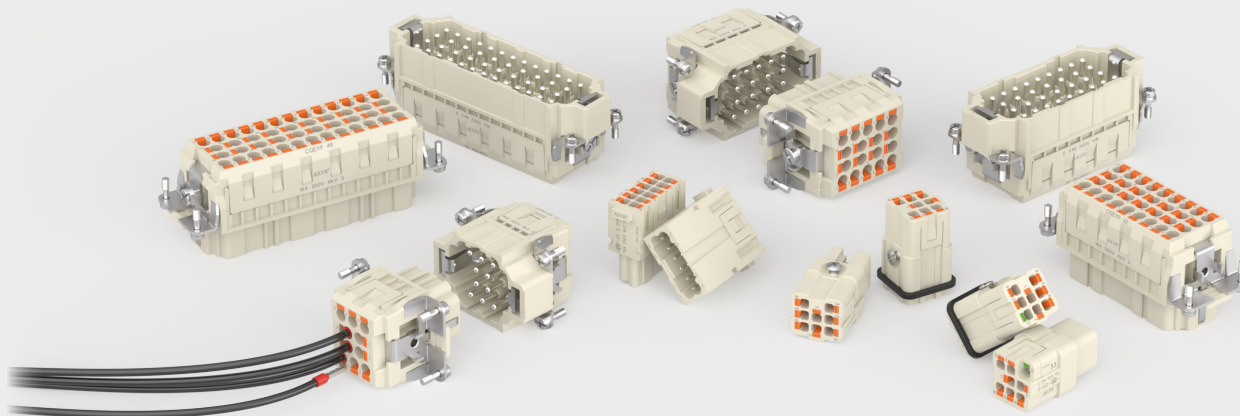

AXYR® 16 A and 10 A novelties

AXYR® CDYF /M 07 and CDYF /M 08

New 10 A inserts
with AXYR® connection technology

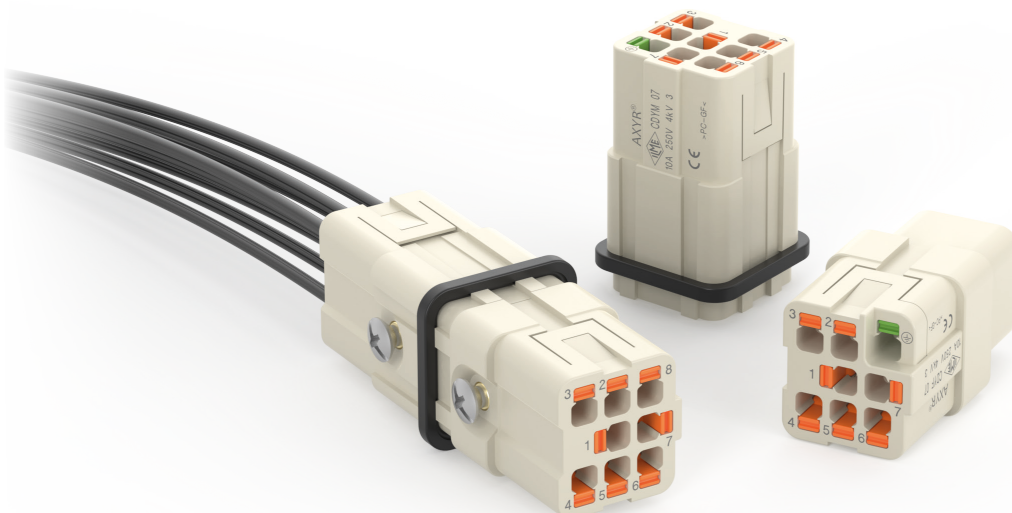

CDY 07

7 P + ⊕: 10 A 250 V 4 kV 3 (230/400 V 4 kV 2)

CDY 08

8 P: 10 A 50 V_{AC} / 120 V_{DC} 0,8 kV 3



Find out more
www.ilme.com

TECHNICAL FEATURES

The **AXYR® technology** is now being implemented in an even more compact version for the 10 A, size “21.21”, connector inserts equivalent to the CDF /M 07 and CDF /M 08 ones of the popular crimp series **CD**. By offering a considerably compact spring push-in termination, which is able – where the contact pitch allows – to equal the density reached by the crimp connection technology with the great advantage of **not requiring any specialized tool**, these new **AXYR®** variants provide a tool-less option in the popular “21.21” square format when more than the 5 contacts of CQ 05 and CQY 05 are required, where the investment in the crimping technology is not justified.

These new models, series **CDY**, respectively:

Q **CDYF /M 07** (7 P + ⊕): 10 A 250 V 4 kV 3 (230/400 V 4 kV 2)

Q **CDYF /M 08** (8 P): 10 A 50 V_{AC} / 120 V_{DC} 0,8 kV 3

for the covered range of wiring provide *interchangeability*, i.e., the highest level of *compatibility*, implying *intermountability* and *intermateability*, with the corresponding crimp versions, respectively CDF /M 07 and CDF /M 08.

The new inserts equipped with **AXYR®** spring push-in technology — whose actuator button is required only for the release of the connection or for opening the terminal when using stranded unprepared wires, or solid or ferruled wires with cross-sectional area < 0,75 mm² / 18 AWG) — offer a wide size range:

Q **0,14 mm² to 1,5 mm² (AWG 26-16)** for ferruled (prepared) flexible copper wires;

Q **0,14 mm² to 2,5 mm² (AWG 24-14)** for unferruled (unprepared) solid or flexible copper wires.

When using solid copper wire or ferruled stranded copper wire with cross-sectional area (CSA) 0,75 mm² / 18 AWG or higher, it is possible to terminate the wire by simple push-in action of the stripped or ferruled wire.

In all other instances (stranded wire or solid or ferruled wire with CSA < 0,75 mm² / 18 AWG) in order to displace the spring and open the terminal, it is necessary to push down the actuator button by using a flat-blade screwdriver 0,5 × 3 mm max.

Q The 8-pole **CDYF /M 08 AXYR®** models, like the affine CDF /M 08 crimp ones, being destined to applications in ELV (extra-low voltage, voltage band I) up to and including 50 V_{AC} / 120 V_{DC}, not requiring a PE (protective earth) contact, are duly **keyed in order to fit both insulating and metallic enclosures size “21.21”**.

Q The 7-pole + ⊕ **CDYF /M 07 AXYR®** models, like the affine CDF /M 07 crimp ones, deemed for uses up to 250 V_{AC/DC} (voltage band II) and having the **AXYR®** PE contact as a pass-through one, not providing PE bonding contact to the surrounding enclosure, are **keyed in order to fit only insulating enclosures size “21.21”**.

Q The mating faces of these 8 P and 7 P + ⊕ **AXYR®** connector inserts are also differently polarized in order to avoid cross-mating of different polarities, while the cross-mating between of variants **AXYR®** and crimp with the same polarity is allowed.

Q Conductors stripping length: 9..11 mm.

Q Silver plated contacts, stainless steel spring and tin plated brass stamped cage terminals.

Q **CKR 65** special screw + sealing gasket replacement for getting IP66/IP67/IP69 degree of protection (standard screw provides degree of protection only when using insulating enclosures).

☑ NOTE – Additional colour coding with dark grey RAL 7002, like formerly in use for CDF /M 07 is no longer applied. CDY 07 and CDY 08 can be easily distinguished by the presence on the CDY 07 inserts of a **green-coloured PE actuator button**, while all buttons of the CDY 08 are **orange-coloured**.

Q Max diameter of wire sheathing or ferrule funnel: ø 3,8 mm (unprepared wire size 2,5 mm² / AWG 14 or ferruled wire size 1,5 mm² / AWG 16)

✓ CERTIFICATIONS

- cURus, CQC, DNV, BV, EAC (only for CDY 07) pending.
- **CE** and **UKCA** markings (only for CDY 07).
- **RoHS**: compliant with exemption 6(c).

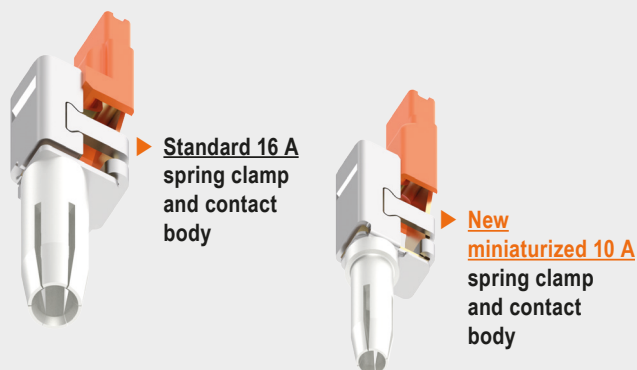

▶ **New terminal opening** for optimized conductors insertion (either ferruled or un-ferruled)

▶ **PE actuator button**

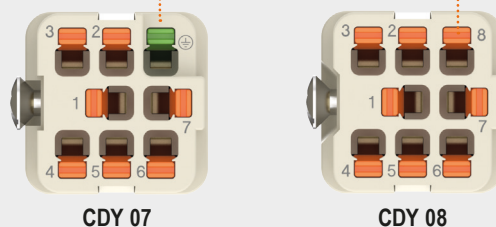

CDY 7 poles + ⊕ 10 A – 250 V

enclosures:
size "21.21"

page:

Insulating type

339 - 348

page:

HYGIENIC CKH-MKH
COB 03/3 BC

108 - 114
134

refer to CN.19 pages

refer to News 2020 pages

AXYR® inserts
push-in spring clamp with actuator button

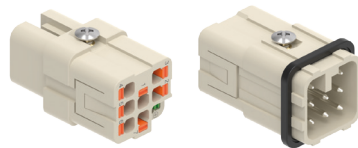

Q SIZE "21.21"

FROM NOVEMBER 2023

description

part No.

spring/AXYR® push-in connection
female insert with female contacts
male insert with male contacts

[CDYF 07](#)
[CDYM 07](#)

- characteristics according to EN 61984:

10 A 250 V 4 kV 3
10 A 230/400 V 4 kV 2

- cURus (ECBT2/8 and PVVA2/8) pending
- CQC, DNV, BV, EAC pending

- rated voltage according to UL/CSA: 600 V
- insulation resistance: $\geq 10 \text{ G}\Omega$
- ambient temperature limit: $-40 \text{ }^\circ\text{C} \dots +125 \text{ }^\circ\text{C}$
- made of self-extinguishing thermoplastic resin UL 94V-0

- mechanical life: ≥ 500 cycles
- contact resistance: $\leq 3 \text{ m}\Omega$
- max diameter of wire sheathing or ferrule funnel:
 $\varnothing 3,8 \text{ mm}$ (unprepared wire size $2,5 \text{ mm}^2$ / AWG 14
or ferruled wire size $1,5 \text{ mm}^2$ / AWG 16)

- for max. current load see the connector inserts
derating diagram below; for more information
see page 28 of CN.19 catalogue.

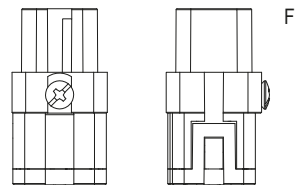
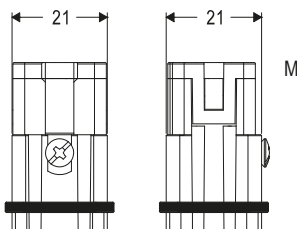

contacts side (front view)

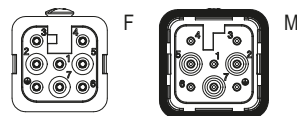

CDY 07 poles connector inserts Maximum current load derating diagram

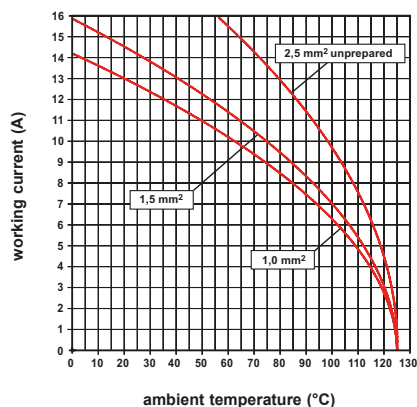

inserts for conductors with the following
cross-sectional areas:

- unprepared conductor
 $0,14 \text{ mm}^2 - 2,5 \text{ mm}^2$ (AWG 26-14)
- prepared conductor with crimped end-sleeve
 $0,14 \text{ mm}^2 - 1,5 \text{ mm}^2$ (AWG 26-16)
- conductors stripping length: 9..11 mm

CDY 8 poles 10 A – 50 V_{AC} / 120 V_{DC}

enclosures:
size "21.21"

page:

Insulating type 339 - 348
Metallic type 349 - 363
W-TYPE for aggressive environments 512 - 518
EMC 564 - 572
IP68 628 - 631
E-Xtreme® corrosion proof 538 - 539

page:

HYGIENIC CKH-MKH 108 - 114
COB 03/3 BC 134

refer to CN.19 pages

refer to News 2020 pages

AXYR® inserts
push-in spring clamp with actuator button

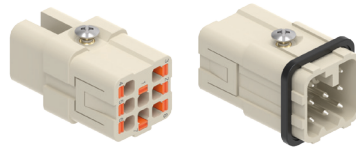

Q SIZE "21.21"

FROM NOVEMBER 2023

description

part No.

spring/AXYR® push-in connection
female insert with female contacts
male insert with male contacts

[CDYF 08](#)
[CDYM 08](#)

- characteristics according to EN 61984:
10 A 50 V_{AC} / 120 V_{DC} 0,8 kV 3

- cURus (ECBT2/8 and PVVA2/8) pending
- CQC, DNV, BV pending

- rated voltage according to UL/CSA: 50 V_{AC} / 120 V_{DC}

- insulation resistance: $\geq 10 \text{ G}\Omega$

- ambient temperature limit: $-40 \text{ }^\circ\text{C} \dots +125 \text{ }^\circ\text{C}$

- made of self-extinguishing thermoplastic resin UL 94V-0

- mechanical life: ≥ 500 cycles

- contact resistance: $\leq 3 \text{ m}\Omega$

- max diameter of wire sheathing or ferrule funnel:
 $\varnothing 3,8 \text{ mm}$ (unprepared wire size $2,5 \text{ mm}^2$ / AWG 14
or ferruled wire size $1,5 \text{ mm}^2$ / AWG 16)

- for max. current load see the connector inserts
derating diagram below; for more information
see page 28 of CN.19 catalogue.

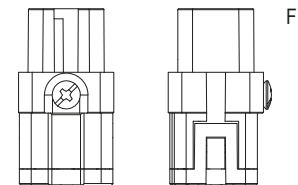
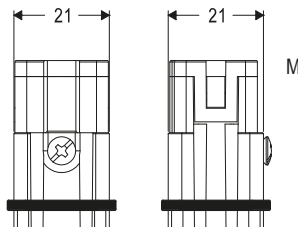

contacts side (front view)

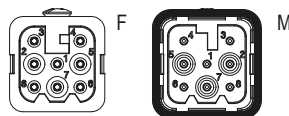

CDY 08 poles connector inserts
Maximum current load derating diagram

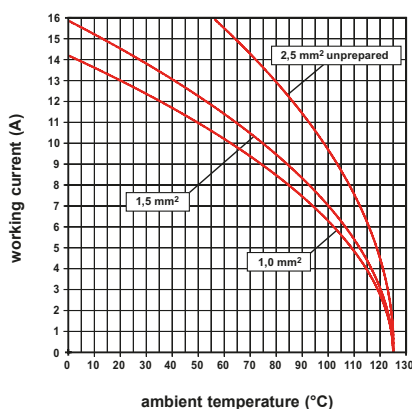

inserts for conductors with the following
cross-sectional areas:

- unprepared conductor
 $0,14 \text{ mm}^2 - 2,5 \text{ mm}^2$ (AWG 26-14)
- prepared conductor with crimped end-sleeve
 $0,14 \text{ mm}^2 - 1,5 \text{ mm}^2$ (AWG 26-16)
- conductors stripping length: 9..11 mm

AXYR® MIXO CX 12 DYF /M

New 10 A MIXO modules with AXYR® connection technology

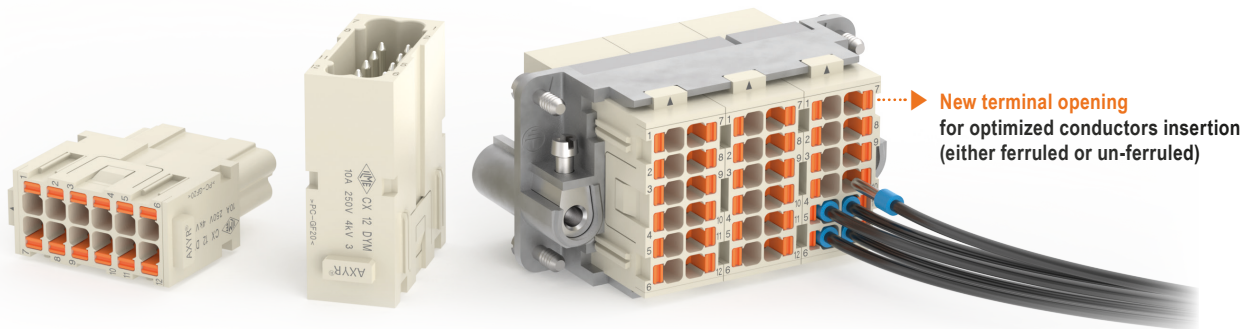

12 P: 10 A 250 V 4 kV 3

The new 12-pole **AXYR® CX 12 DYF/ M** MIXO modules are the tool-less variant of the popular crimp version CX 12 DF /M.

The 10 A range with **AXYR®** spring push-in technology — whose actuator button is required only for release purposes or for wiring with stranded copper wires or ferruled or solid wires with CSA < 0,75 mm² / 18 AWG — allows these inserts to cover with one size the whole wire ranges:

- Q 0,14 mm² to 1,5 mm² (AWG 26-16) for ferruled (prepared) flexible copper wires;
- Q 0,14 mm² to 2,5 mm² (AWG 24-14) for unferruled (unprepared) solid or flexible copper wires;

without need for additional crimping tools.

While crimping is a special process requiring skill, the **AXYR®** technology, being so simple, is virtually skill-independent and provides tool-less connection for contact densities that

the **SQUICH®** technology cannot achieve even in its most compact version.

- Q Current-temperature derating diagrams (current-carrying capacity curves) for the **CX 12 DYF/ M AXYR®** module are like those of the equivalent CX 12 DF /M crimp version for the same wiring.
- Q Conductors stripping length: 9..11 mm
- Q Silver plated contacts
- Q Max diameter of wire sheathing or ferrule funnel:
ø 3,8 mm (unprepared wire size 2,5 mm² / AWG 14 or ferruled wire size 1,5 mm² / AWG 16)

✓ CERTIFICATIONS

- cURus, CQC, DNV, BV, EAC pending.
- **CE** and **UKCA** markings.
- **RoHS**: compliant with exemption 6(c).

CX 12 DY 12 poles 10 A – 250 V

The modular inserts must be installed in suitable frames, which are then mounted in traditional enclosures* or in COB panel supports

Single-sized modular units may be directly mounted inside MIXO ONE and MIXO TWO enclosures

frames for modular units
MIXO ONE enclosures

page:
316 - 317
369

MIXO TWO enclosures

page:
76, 77

refer to CN.19 pages

modular units,
AXYR® terminal connections

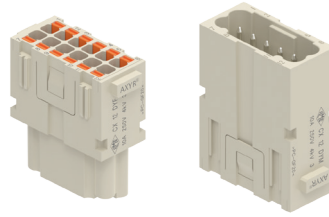

Q SILVER PLATED CONTACTS

FROM NOVEMBER 2023

description

part No.

spring/AXYR® push-in connection
female insert with female contacts
male insert with male contacts

[CX 12 DYF](#)
[CX 12 DYM](#)

- characteristics according to EN 61984:
10 A 250 V 4 kV 3

- cURus (ECBT2/8 and PVVA2/8) pending
- CQC, DNV, BV, EAC pending

- rated voltage according to UL/CSA: 600 V
- insulation resistance: $\geq 10 \text{ G}\Omega$
- ambient temperature limit: $-40 \text{ }^\circ\text{C} \dots +125 \text{ }^\circ\text{C}$
- made of self-extinguishing thermoplastic resin UL 94V-0
- mechanical life: ≥ 500 cycles
- contact resistance: $\leq 3 \text{ m}\Omega$
- max diameter of wire sheathing or ferrule funnel:
 $\varnothing 3,8 \text{ mm}$ (unprepared wire size $2,5 \text{ mm}^2$ / AWG 14
or ferruled wire size $1,5 \text{ mm}^2$ / AWG 16)

- for max. current load see the connector inserts derating diagram below; for more information see page 28 of CN.19 catalogue.

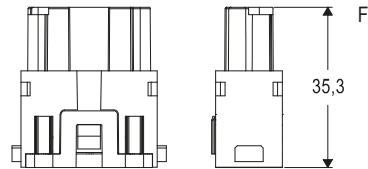
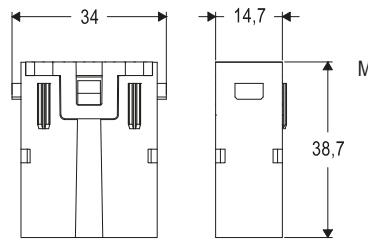

contacts side (front view)
side with reference arrow ▲

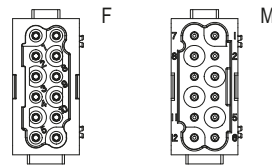

Q Please refer to page 39 for the MIXO AXYR® range

CX 12 DY, 12 poles connector inserts
Maximum current load derating diagram

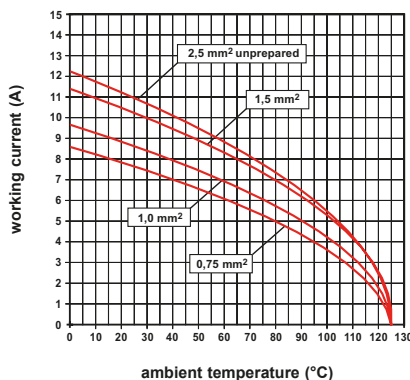

inserts for conductors with the following cross-sectional areas:

- unprepared conductor
0,14 mm² - 2,5 mm² (AWG 26-14)
- prepared conductor with crimped end-sleeve
0,14 mm² - 1,5 mm² (AWG 26-16)
- conductors stripping length: 9..11 mm

AXYR® Variant of CQE crimp series

CQEYF /M 10 - 18 - 32 - 46 - 64 (2× 32) - 92 (2× 46)

**New 16 A inserts
with AXYR® connection technology**

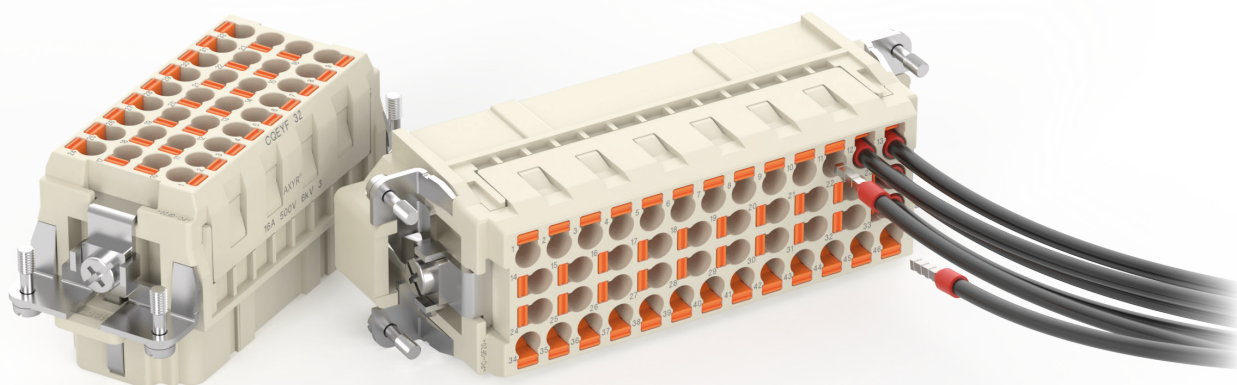

**Available in the standard sizes
and double-inserts sizes**

CQEY

16 A 500 V 6 kV 3 (830 V 8 kV 2)



Find out more
www.ilme.com

TECHNICAL FEATURES

The 16 A range of connector inserts using the **AXYR® technology** (spring push-in with actuator button) which can equal the crimp connectors versions in terms of high density without requiring any crimping tool, is furtherly widened by the **new series CQEY**, intermateable with the corresponding available models of series **CQE** (crimp)^(#).

The crimp series CQE, born as the high-density version of the historic crimp series **CCE**, is now made available in a tool-less version.

The **AXYR®** 16 A toolless spring push-in contacts cover a wiring range:

- Q **0,25 mm² to 2,5 mm² (AWG 24-14)** for ferruled (prepared) flexible copper wires;
- Q **0,25 mm² to 4 mm² (AWG 24-12)** for unferruled (unprepared) solid or flexible copper wires.

NOTE – Crimp contacts series CC for the intermateable series CQE are provided either silver plated or gold plated in sizes ranging from 0.3 through 4.0, covering cross-sectional areas from 0,14 mm² / 26 AWG to 4 mm² / 12 AWG.

Like for series CQE, the inserts of **AXYR®** series CQEY are available in the *standard sizes* and *double-inserts sizes*.

As improvement over series **CQE**, series **CQEY** connector inserts allow **additional coding of the mating face** by means of **CR Q08E** coding pins, that must be fitted in the dedicated dovetail-shaped seats on the contour of the mating face in specular pattern:

- Q **CQEY 10** and **CQEY 18** are provided with **3 seats** for the optional coding pins **CR Q08E** on each part of the connector. On these sizes is possible to achieve up to 6 different codings: 3 coding pins are required for each connector coupling (two fitted on one connector part, one fitted specularly on the other connector part); it is necessary to install two coding pins on each connector part.
- Q **CQEY 18** and **CQEY 46** are provided with **4 seats** for the optional coding pins **CR Q08E** on each part of the connector. On these sizes is possible to achieve up to 6 different codings: 4 coding pins are required for each connector coupling (two fitted on one connector part, two on the opposite connector part in specular way). It is necessary to install two coding pins on each connector part.

NOTE – Coded connector parts (male or female) of series CQEY cannot be coupled to corresponding connector parts (female or male) of series CQE, only uncoded connector parts of series CQEY can be coupled to corresponding connector parts of series CQE. Performance of a mixed CQEY/CQE coupling is equivalent to that of an equivalent unmixed (CQE/CQE or CQEY/CQEY) coupling where both sides are wired with the lowest of the wire sizes used by the mixed coupling, considering the slightly narrower range covered by **AXYR®** series CQEY when using ferruled (prepared) stranded copper wires (0,25 mm² to 2,5mm², AWG 24-14) vs crimp series CQE (0,14 mm² to 4 mm², AWG 26-12).

- Q **Current-temperature derating diagrams** (current-carrying capacity curves): like those of the equivalent CQE crimp versions of the same-sized wiring.
- Q **Conductors stripping length**: 9..11 mm.
- Q Silver plated contacts, stainless steel spring and tin plated brass stamped cage terminals (gold plated contact versions are not foreseen).
- Q **Actuator button of line contacts**: orange colour, to be operated by means of a flat-blade screwdriver sized 0,5 × 3 mm.
- Q **PE terminal**: screw-type, on the PE side bracket closer to line contact #1. Suitable for up to two wires (one on each side of the terminal under the pressure plate) sized up to 2,5 mm² / 14 AWG.
- Q Max diameter of wire sheathing or ferrule funnel:
 - ∅ 5 mm (unprepared wire size 4 mm² / AWG 12 or ferruled wire size 2,5 mm² / AWG 14)

CERTIFICATIONS

- cURus, CQC, DNV, BV, EAC pending.
- **CE** and **UKCA** markings.
- **RoHS**: compliant with exemption **6(c)**.

^(#) Intermateability with series CQE (crimp) is ensured within the features of the new **AXYR®** CQEY series, considering the slightly different wiring range between the two series when using stranded ferruled (prepared) copper wires and the added coding feature of the new **AXYR®** CQEY series that series CQE does not yet provide.

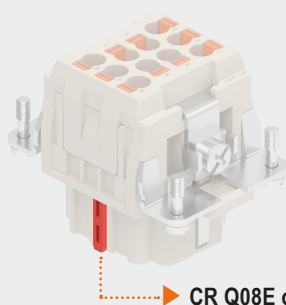

- ▶ **Required pins to correctly code a coupling:**
 - **3 pins** for 10 and 18 poles connectors
 - **4 pins** for 32, 46, 64 and 92 poles connectors

▶ **CR Q08E optional plastic coding pins** for up to 6 configurations

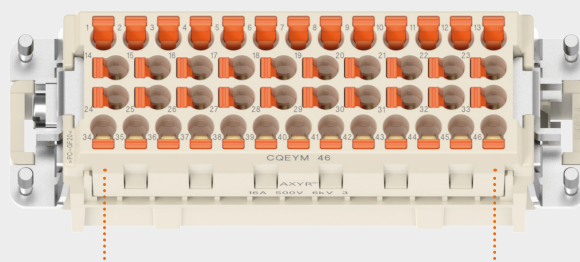

▶ **High contacts density**

CQEY 10 poles + ⊕ 16 A – 500 V

enclosures:
size "44.27"

page:

C-TYPE IP65 or IP66/IP69	387 - 392
C7 IP67, single lever	436 - 437
V-TYPE IP65 or IP66/IP69, single lever	444 - 447
BIG hoods	466 - 467
T-TYPE IP65 insulating	480 - 481
T-TYPE/W IP66/IP69 insulating	489
HYGIENIC T-TYPE/H IP66/IP69	501
HYGIENIC T-TYPE/C IP66/IP69, -50 °C	506
W-TYPE for aggressive environments	521
E-Xtreme® corrosion proof	530 - 531, 542, 550 - 551
EMC	578
Central lever	603 - 605
LS-TYPE	618 - 619
IP68	632 - 635

panel supports:
COB

652 - 653

refer to CN.19 pages

AXYR® inserts,
push-in spring clamp with actuator button

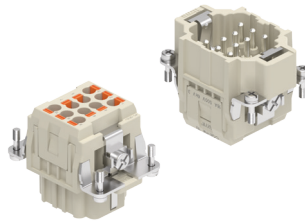

coding pins



Q SILVER PLATED CONTACTS
FROM SEPTEMBER 2023

description	part No.	part No.
-------------	----------	----------

spring/AXYR® push-in connection
female insert with female contacts
male insert with male contacts

[CQEYF 10](#)
[CQEYM 10](#)

plastic coding pin

[CR Q08E](#)

- characteristics according to EN 61984:

16 A 500 V 6 kV 3
16 A 830 V 8 kV 2

- cURus (ECBT2/8 and PVVA2/8) pending
- CQC, DNV, BV, EAC pending

- rated voltage according to UL/CSA: 600 V
- insulation resistance: ≥ 10 GΩ
- ambient temperature limit: -40 °C ... +125 °C
- made of self-extinguishing thermoplastic resin UL 94V-0
- mechanical life: ≥ 500 cycles
- contact resistance: ≤ 3 mΩ
- max diameter of wire sheathing or ferrule funnel: ø 5 mm (unprepared wire size 4 mm² / AWG 12 or ferruled wire size 2,5 mm² / AWG 14)

- for max. current load see the connector inserts derating diagram below; for more information see page 28 of CN.19 catalogue.

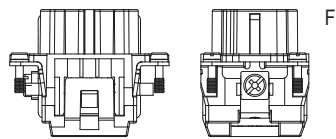
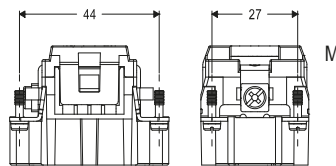

contacts side (front view)

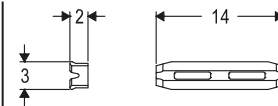
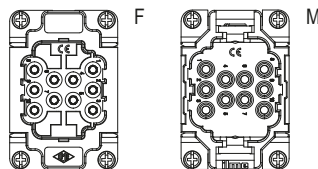

Q Coding pins to be ordered separately.

Q It is possible to achieve up to **6 different codings** thanks to the use of the optional CR Q08E coding pin: 3 coding pins are required for each connector coupling.

CQEY 10 poles connector inserts Maximum current load derating diagram

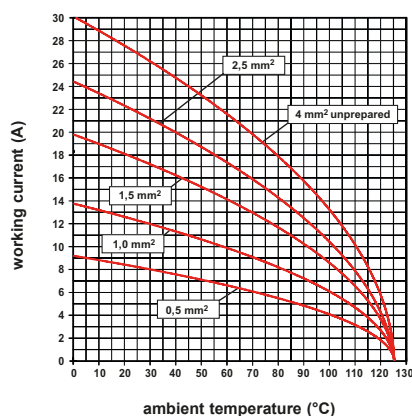

inserts for conductors with the following cross-sectional areas:

- unprepared conductor
0,25 mm² - 4 mm² (AWG 24-12)
- prepared conductor with crimped end-sleeve
0,25 mm² - 2,5 mm² (AWG 24-14)
- conductors stripping length: 9..11 mm

CQEY 18 poles + ⊕ 16 A – 500 V

enclosures:
size "57.27"

page:

C-TYPE IP65 or IP66/IP69	393 - 401
C7 IP67, two levers	438
V-TYPE IP65 or IP66/IP69, single lever	448 - 453
BIG hoods	468 - 469
T-TYPE IP65 insulating	482 - 483
T-TYPE/W IP66/IP69 insulating	490
HYGIENIC T-TYPE/H IP66/IP69	502
HYGIENIC T-TYPE/C IP66/IP69, -50 °C	507
W-TYPE for aggressive environments	522
E-Xtreme® corrosion proof	532 - 533, 543, 552 - 553
EMC	579
Central lever	606 - 608
LS-TYPE	620 - 621
IP68	636 - 639

panel supports:
COB

652 - 653

refer to CN.19 pages

AXYR® inserts,
push-in spring clamp with actuator button

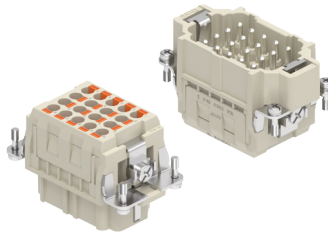

coding pins



Q SILVER PLATED CONTACTS
FROM SEPTEMBER 2023

description

part No.

part No.

spring/AXYR® push-in connection
female insert with female contacts
male insert with male contacts

[CQEYF 18](#)
[CQEYM 18](#)

plastic coding pin

[CR Q08E](#)

- characteristics according to EN 61984:

16 A 500 V 6 kV 3
16 A 830 V 8 kV 2

- cURus (ECBT2/8 and PVVA2/8) pending
- CQC, DNV, BV, EAC pending

- rated voltage according to UL/CSA: 600 V
- insulation resistance: $\geq 10 \text{ G}\Omega$
- ambient temperature limit: $-40 \text{ }^\circ\text{C} \dots +125 \text{ }^\circ\text{C}$
- made of self-extinguishing thermoplastic resin UL 94V-0
- mechanical life: ≥ 500 cycles
- contact resistance: $\leq 3 \text{ m}\Omega$
- max diameter of wire sheathing or ferrule funnel: $\varnothing 5 \text{ mm}$ (unprepared wire size 4 mm^2 / AWG 12 or ferruled wire size $2,5 \text{ mm}^2$ / AWG 14)

- for max. current load see the connector inserts derating diagram below; for more information see **page 28** of CN.19 catalogue.

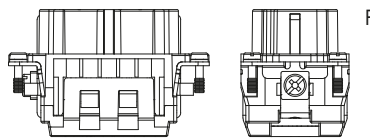
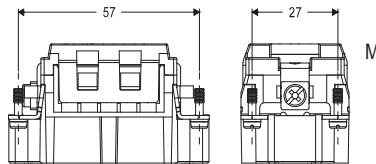

contacts side (front view)

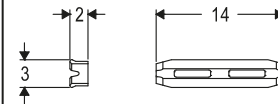
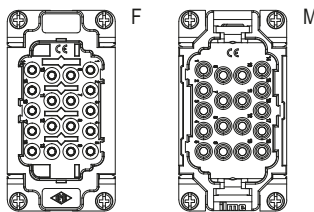

Q Coding pins to be ordered separately.

Q It is possible to achieve up to **6 different codings** thanks to the use of the optional CR Q08E coding pin: 3 coding pins are required for each connector coupling.

CQEY 18 poles connector inserts Maximum current load derating diagram

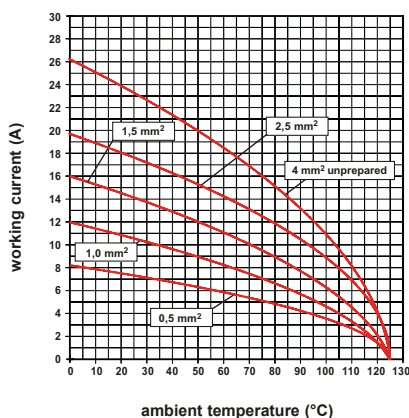

inserts for conductors with the following cross-sectional areas:

- unprepared conductor
0,25 mm² - 4 mm² (AWG 24-12)
- prepared conductor with crimped end-sleeve
0,25 mm² - 2,5 mm² (AWG 24-14)
- conductors stripping length: 9..11 mm

CQEY 32 poles + ⊕ 16 A – 500 V

enclosures:
size "77.27"

page:

C-TYPE IP65 or IP66/IP69	402 - 411
C7 IP67, two levers	439 - 440
V-TYPE IP65 or IP66/IP69, single lever	454 - 458
BIG hoods	470 - 471
T-TYPE IP65 insulating	484 - 485
T-TYPE/W IP66/IP69 insulating	491
HYGIENIC T-TYPE/H IP66/IP69	503
HYGIENIC T-TYPE/C IP66/IP69, -50 °C	508
W-TYPE for aggressive environments	523
E-Xtreme® corrosion proof	534 - 535, 544, 554 - 555
EMC	580
Central lever	609 - 611
LS-TYPE	622 - 623
IP68	640 - 643

panel supports:
COB

652 - 653

refer to CN.19 pages

AXYR® inserts,
push-in spring clamp with actuator button

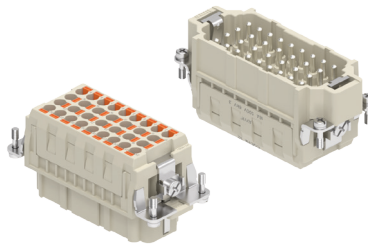

Q SILVER PLATED CONTACTS
FROM SEPTEMBER 2023

coding pins



description

part No.

part No.

spring/AXYR® push-in connection
female insert with female contacts
male insert with male contacts

[CQEYF 32](#)
[CQEYM 32](#)

plastic coding pin

[CR Q08E](#)

- characteristics according to EN 61984:

16 A 500 V 6 kV 3
16 A 830 V 8 kV 2

- cURus (ECBT2/8 and PVVA2/8) pending
- CQC, DNV, BV, EAC pending

- rated voltage according to UL/CSA: 600 V
- insulation resistance: $\geq 10 \text{ G}\Omega$
- ambient temperature limit: $-40 \text{ }^\circ\text{C} \dots +125 \text{ }^\circ\text{C}$
- made of self-extinguishing thermoplastic resin UL 94V-0
- mechanical life: ≥ 500 cycles
- contact resistance: $\leq 3 \text{ m}\Omega$
- max diameter of wire sheathing or ferrule funnel: $\varnothing 5 \text{ mm}$ (unprepared wire size 4 mm^2 / AWG 12 or ferruled wire size $2,5 \text{ mm}^2$ / AWG 14)

- for max. current load see the connector inserts derating diagram below; for more information see page 28 of CN.19 catalogue.

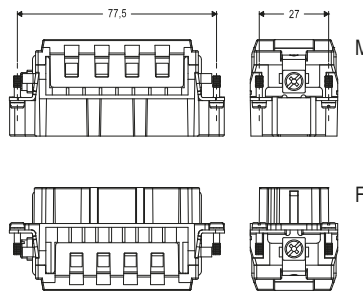

contacts side (front view)

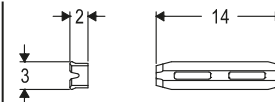
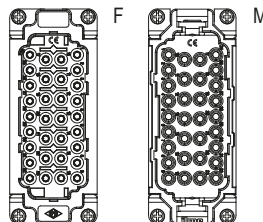

- Q Coding pins to be ordered separately.
- Q It is possible to achieve up to **6 different codings** thanks to the use of the optional CR Q08E coding pin: 4 coding pins are required for each connector coupling.
- Q It is necessary to install **two** coding pins on each connector part.

CQEY 32 poles connector inserts
Maximum current load derating diagram

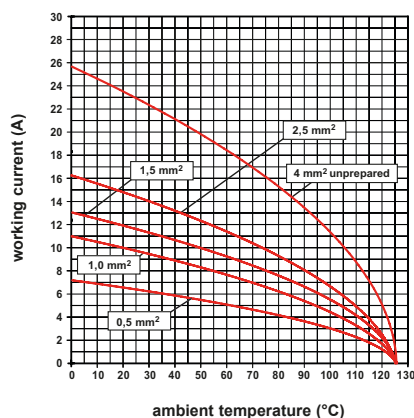

inserts for conductors with the following cross-sectional areas:

- unprepared conductor
0,25 mm² - 4 mm² (AWG 24-12)
- prepared conductor with crimped end-sleeve
0,25 mm² - 2,5 mm² (AWG 24-14)
- conductors stripping length: 9..11 mm

CQEY 46 poles + ⊕ 16 A – 500 V

enclosures:
size "104.27"

page:

C-TYPE IP65 or IP66/IP69	412 - 423
C7 IP67, two levers	441 - 442
V-TYPE IP65 or IP66/IP69, single lever	459 - 463
BIG hoods	472 - 473
T-TYPE IP65 insulating	486 - 487
T-TYPE/W IP66/IP69 insulating	492
HYGIENIC T-TYPE/H IP66/IP69	504
HYGIENIC T-TYPE/C IP66/IP69, -50 °C	509
W-TYPE for aggressive environments	524
E-Xtreme® corrosion proof	536 - 537, 545, 556 - 557
EMC	581
Central lever	612 - 614
LS-TYPE	624 - 625
IP68	644 - 647

panel supports:
COB

652 - 653

refer to CN.19 pages

AXYR® inserts,
push-in spring clamp with actuator button

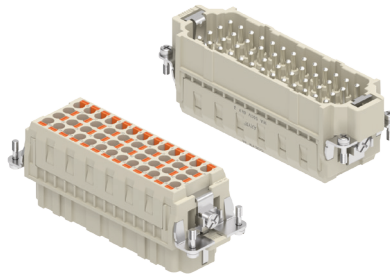

coding pins



Q SILVER PLATED CONTACTS
FROM SEPTEMBER 2023

description

part No.

part No.

spring/AXYR® push-in connection
female insert with female contacts
male insert with male contacts

[CQEYF 46](#)
[CQEYM 46](#)

plastic coding pin

[CR Q08E](#)

- characteristics according to EN 61984:

16 A 500 V 6 kV 3
16 A 830 V 8 kV 2

- cURus (ECBT2/8 and PVVA2/8) pending
- CQC, DNV, BV, EAC pending

- rated voltage according to UL/CSA: 600 V
- insulation resistance: ≥ 10 GΩ
- ambient temperature limit: -40 °C ... +125 °C
- made of self-extinguishing thermoplastic resin UL 94V-0
- mechanical life: ≥ 500 cycles
- contact resistance: ≤ 3 mΩ
- max diameter of wire sheathing or ferrule funnel:
ø 5 mm (unprepared wire size 4 mm² / AWG 12
or ferruled wire size 2,5 mm² / AWG 14)

- for max. current load see the connector inserts
derating diagram below; for more information
see page 28 of CN.19 catalogue.

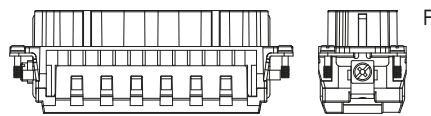
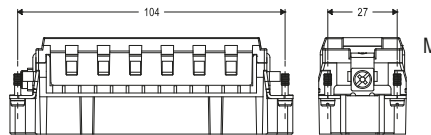

contacts side (front view)

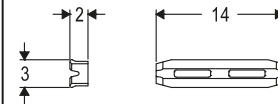
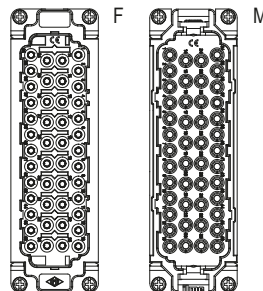

Q Coding pins to be ordered separately.

Q It is possible to achieve up to **6 different codings** thanks to the use of the optional CR Q08E coding pin: 4 coding pins are required for each connector coupling.

Q It is necessary to install **two** coding pins on each connector part.

CQEY 46 poles connector inserts Maximum current load derating diagram

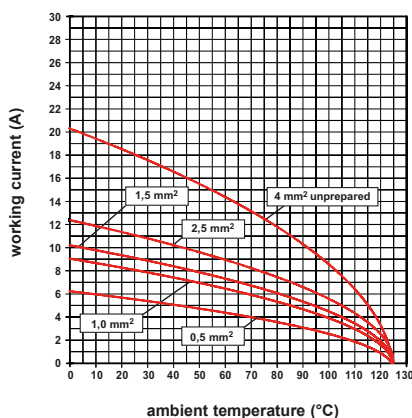

inserts for conductors with the following
cross-sectional areas:

- unprepared conductor
0,25 mm² - 4 mm² (AWG 24-12)
- prepared conductor with crimped end-sleeve
0,25 mm² - 2,5 mm² (AWG 24-14)
- conductors stripping length: 9..11 mm

CQEY 64 poles + ⊕ 16 A – 500 V

enclosures:
size "77.62"

page:

C-TYPE IP65 or IP66/IP69
W-TYPE for aggressive environments
E-Xtreme® corrosion proof

424 - 429
525
546

AXYR® inserts,
push-in spring clamp with actuator button

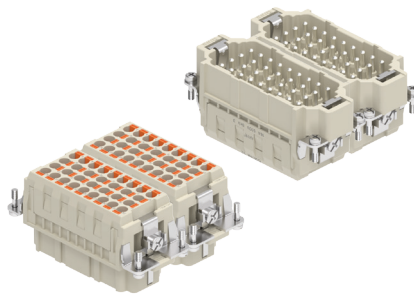

coding pins



Q SILVER PLATED CONTACTS
FROM SEPTEMBER 2023

refer to CN.19 pages

description	part No.	part No.	part No.
-------------	----------	----------	----------

spring/AXYR® push-in connection
female insert with female contacts, No. (1-32) and (33-64)
male insert with male contacts, No. (1-32) and (33-64)

[CQEYF 32](#)
[CQEYM 32](#)

[CQEYF 32 N](#)
[CQEYM 32 N](#)

plastic coding pin

[CR Q08E](#)

- characteristics according to EN 61984:

16 A 500 V 6 kV 3
16 A 830 V 8 kV 2

- cURus (ECBT2/8 and PVVA2/8) pending
- CQC, DNV, BV, EAC pending

- rated voltage according to UL/CSA: 600 V
- insulation resistance: $\geq 10 \text{ G}\Omega$
- ambient temperature limit: $-40 \text{ }^\circ\text{C} \dots +125 \text{ }^\circ\text{C}$
- made of self-extinguishing thermoplastic resin UL 94V-0
- mechanical life: ≥ 500 cycles
- contact resistance: $\leq 3 \text{ m}\Omega$
- max diameter of wire sheathing or ferrule funnel: $\varnothing 5 \text{ mm}$ (unprepared wire size 4 mm^2 / AWG 12 or ferruled wire size $2,5 \text{ mm}^2$ / AWG 14)

- for max. current load see the connector inserts derating diagram below; for more information see page 28 of CN.19 catalogue.

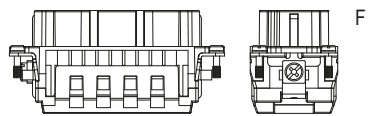
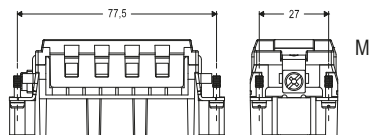

contacts side (front view)

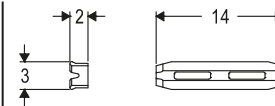
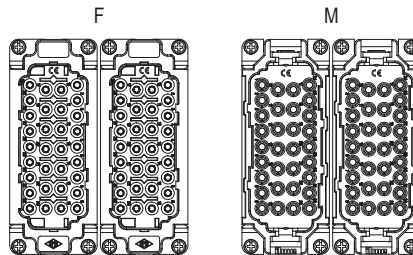

- Q Coding pins to be ordered separately.
- Q It is possible to achieve up to **6 different codings** thanks to the use of the optional CR Q08E coding pin: 4 coding pins are required for each connector coupling.
- Q It is necessary to install **two** coding pins on each connector part.

CQEY 64 poles connector inserts Maximum current load derating diagram

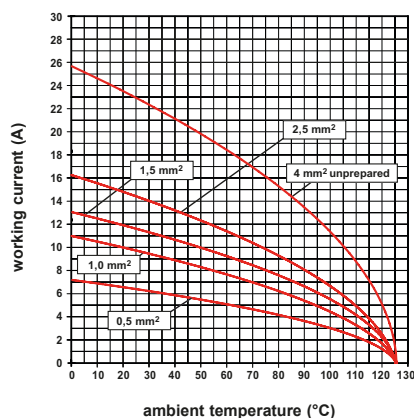

inserts for conductors with the following cross-sectional areas:

- unprepared conductor
0,25 mm² - 4 mm² (AWG 24-12)
- prepared conductor with crimped end-sleeve
0,25 mm² - 2,5 mm² (AWG 24-14)
- conductors stripping length: 9..11 mm

CQEY 92 poles + ⊕ 16 A – 500 V

enclosures:
size "104.62"

C-TYPE IP65 or IP66/IP69
W-TYPE for aggressive environments
E-Xtreme® corrosion proof

page:
430
526
547

AXYR® inserts,
push-in spring clamp with actuator button

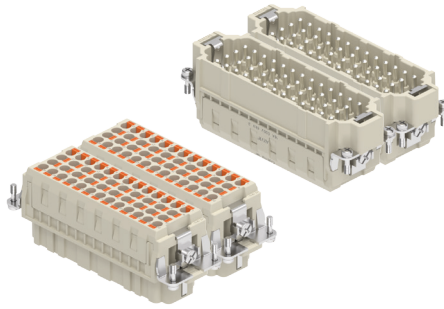

coding pins



Q SILVER PLATED CONTACTS

FROM SEPTEMBER 2023

refer to CN.19 pages

description	part No.	part No.	part No.
spring/AXYR® push-in connection female insert with female contacts, No. (1-46) and (47-92) male insert with male contacts, No. (1-46) and (47-92)	CQEYF 46 CQEYM 46	CQEYF 46 N CQEYM 46 N	
plastic coding pin			CR Q08E

- characteristics according to EN 61984:

16 A 500 V 6 kV 3
16 A 830 V 8 kV 2

- cURus (ECBT2/8 and PVVA2/8) pending
- CQC, DNV, BV, EAC pending

- rated voltage according to UL/CSA: 600 V
- insulation resistance: $\geq 10 \text{ G}\Omega$
- ambient temperature limit: $-40 \text{ }^\circ\text{C} \dots +125 \text{ }^\circ\text{C}$
- made of self-extinguishing thermoplastic resin UL 94V-0
- mechanical life: ≥ 500 cycles
- contact resistance: $\leq 3 \text{ m}\Omega$
- max diameter of wire sheathing or ferrule funnel: $\varnothing 5 \text{ mm}$ (unprepared wire size 4 mm^2 / AWG 12 or ferruled wire size $2,5 \text{ mm}^2$ / AWG 14)

- for max. current load see the connector inserts derating diagram below; for more information see page 28 of CN.19 catalogue.

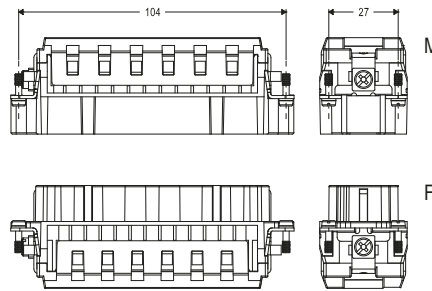

contacts side (front view)

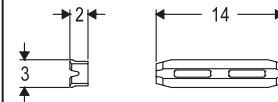
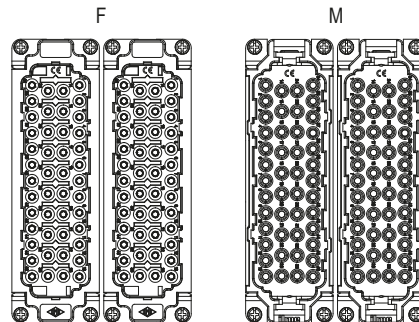

Q Coding pins to be ordered separately.

Q It is possible to achieve up to **6 different codings** thanks to the use of the optional CR Q08E coding pin: 4 coding pins are required for each connector coupling.

Q It is necessary to install **two** coding pins on each connector part.

CQEY 92 poles connector inserts Maximum current load derating diagram

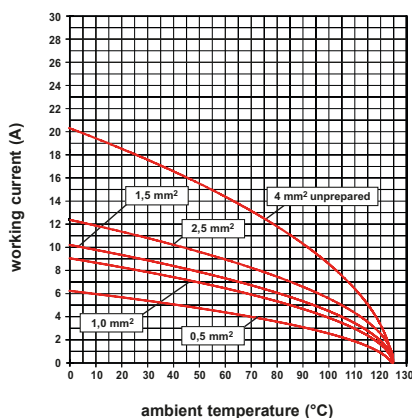

inserts for conductors with the following cross-sectional areas:

- unprepared conductor
0,25 mm² - 4 mm² (AWG 24-12)
- prepared conductor with crimped end-sleeve
0,25 mm² - 2,5 mm² (AWG 24-14)
- conductors stripping length: 9..11 mm

MIXO NOVELTIES

The MIXO series, featuring a flexible modular design for utmost versatile connector creation with easy and safe installation, is again furtherly expanded, with the addition of **6 new modules** (1 single-sized, 5 double-sized, all variants intermateable with existing ones), widening the MIXO portfolio to **76 modules**, as follows:

- **CX 12 DYF /M**
new MIXO AXYR® 10 A module 21, 39
 single-sized, 12 poles, 10 A (spring/AXYR®)
 rating: 10 A 250 V 4 kV 3

- **CX 01 /01B 30F /M**
new MIXO 300 A module..... 42
 double-sized, 1 pole, 300 A, crimp
 rating: 300 A 1000 V 8 kV 3

- **CX 01 /01B 30PEF /M**
new MIXO 300 A PE module 44
 double-sized, 1 PE pole, 300 A, crimp

- **CX 01 30AF /M**
new MIXO 300 A 90° angled module 50
 double-sized, 1 pole, 300 A, 90° angled, screw
 rating: 300 A 1000 V 8 kV 3

- **CX 01 30PEAF /M**
new MIXO 300 A 90° angled PE module 52
 double-sized, 1 PE pole, 300 A, 90° angled, screw

- **CX 02 MPBF /M**
new MIXO module for metal removable
pneumatic contacts..... 58, 59
 double-sized, for use with new pneumatic metal contacts
 for tube \varnothing 8 mm and \varnothing 10 mm, straight, with hose barbs (inner \varnothing)
 or quick-fitting (outer \varnothing), female contacts with or without shut-off valve



Find out more
www.ilme.com

In addition to MIXO series advances (page 36), each of the new modules adds the following **individual features**:

- ▣ **fast, tool-less AXYR® push-in wiring of 12-pole connector modules**, for up to 1 0 A per pole at up to 250 V, mateable with standard counterpart MIXO crimp module CX 12 DF /M (MIXO CX 12 DYF /M);
- ▣ **higher-current, line/neutral crimp connections, with additional finger proof safety**, with two sizes: **01** for different range of wire sizes 16 mm² to 70 mm², **01B** for 95 mm² and 120 mm², for up to 300 A per pole at up to 1 000 V, with new crimp contacts **C30 series** (7 different sizes available, male contacts with insulating tip, for finger proof safety);
- ▣ **higher-current, PE crimp connections**, with two sizes: **01** for different range of wire sizes 16 mm² to 70 mm², **01B** for 95 mm² and 120 mm², for up to 300 A rated current of the corresponding line circuit, with new crimp contacts **C30 series** (7 different sizes available);
- ▣ **higher-current, line/neutral 90°-angled screw connection for tubular cable lugs**, at the rear of bulkhead-mounting housings, for tight 90° change of direction of suitably terminated line/neutral power cables for rated voltages up to 1 000 V and rated currents up to 300 A per pole; mateable with the new standard counterpart MIXO power crimp modules CX 01 /01B 30F /30M (CX 01 /01B 30AF /30AM);
- ▣ **higher-current, PE 90°-angled screw connection for tubular cable lugs**, at the rear of bulkhead-mounting housings, for tight 90° change of direction of suitably terminated PE power cables for rated currents up to 300 A of the corresponding line circuit; mateable with the new standard counterpart MIXO PE power crimp modules CX 01 /01B 30PEF /M (CX 01 /01B 30PEAF /M);
- ▣ **larger diameter, higher flow rate metal pneumatic contacts in a dedicated new 2-seats MIXO module**, for use with the new pneumatic contacts CX xx MPF /MPQF /MPV /MPM /MPQM (xx = 8.0 or 10), straight, with hose barbs (inner ø) or quick-fitting (outer ø), female contacts with or without shut-off valve (CX 02 MPBF /M).

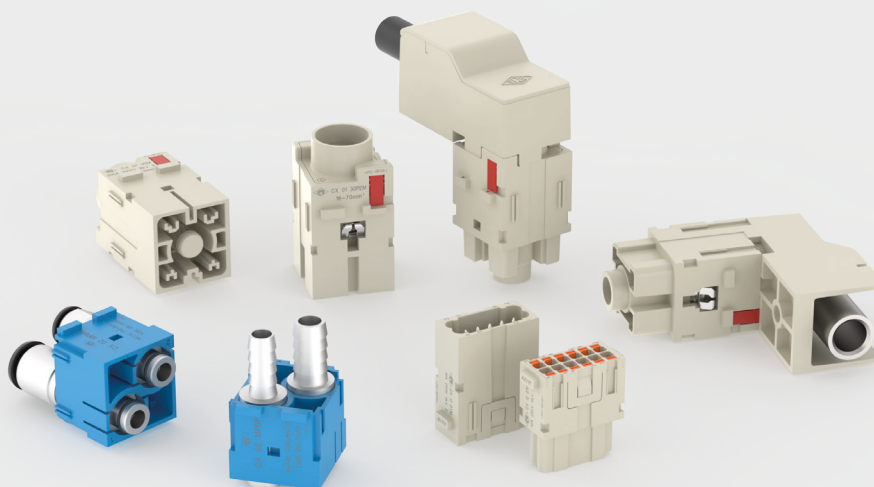

MIXO NOVELTIES AT A GLANCE

MIXO SERIES

GENERAL OVERVIEW

The MIXO series is a system of modular units for special applications that uses the traditional ILME enclosures. Each enclosure can house different types of connections such as: electric signals and contacts for the conduction of compressed air with pressure values of up to 10 bar.

The inserts are arranged side by side to form a single **compact block** which is inserted into metallic frames with constrained positioning. Once the modules have been inserted and locked with the special tabs, the connector can be placed into the enclosure.

The modular system makes it easy to access a series of contacts inserted in the frame (e.g., for substitution, check or the addition of signals with new inserts for needs not foreseen during the initial installation) without having to disassemble the entire connector.

ILME MIXO series of modular connectors is an open connector system that provides versatile configuration to the users' individual requirements, giving the **freedom to assemble a customized connector** from a range of 76 modules for power electrical, data transmission, optical signals or air. The module range is continuously expanded, allowing new configurations to be realised.

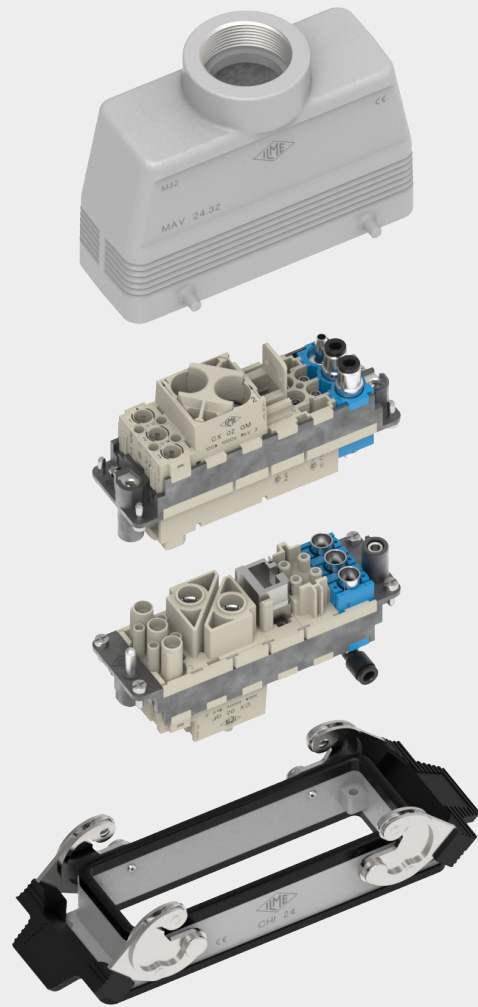

📌 The use of enclosures provides the possibility of innumerable applications.

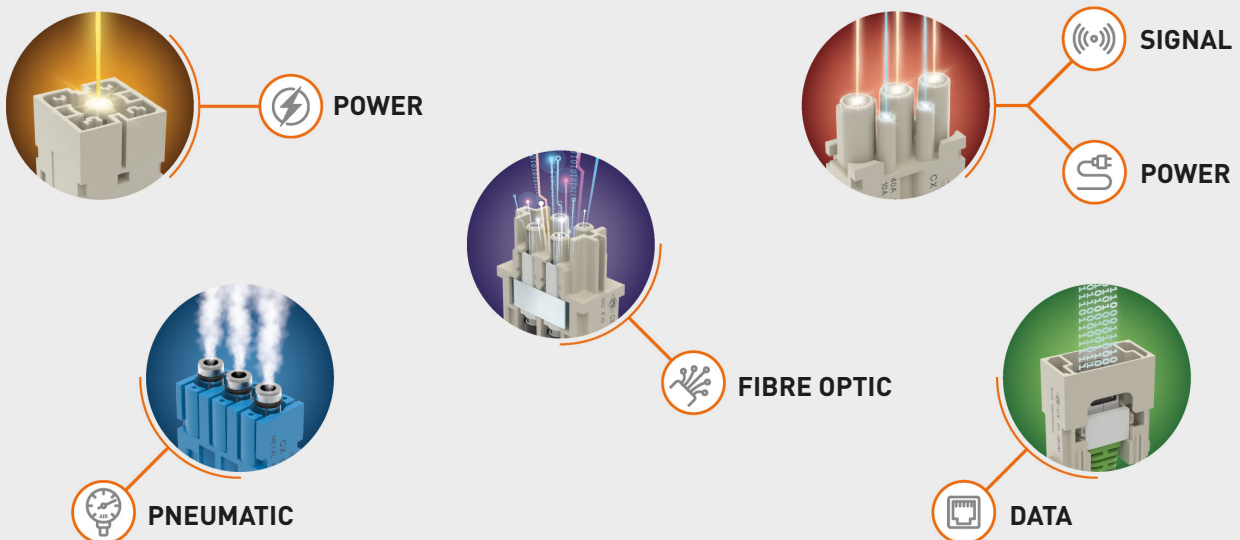

The MIXO series can be used with **5 different frame sizes**:

Frames	one or two-lever metallic enclosures
CX 01 T	size "49.16"
CX 02 TF/ TM	size "44.27"
CX 03 TF/ TM	size "57.27"
CX 04 TF/ TM	size "77.27"
CX 06 TF/ TM	size "104.27"
CX 04 TF/ TM (x 2)	size "77.62"
CX 06 TF/ TM (x 2)	size "104.62"

Single-sized modules, where specified, can also be installed directly inside **MIXO ONE** and **MIXO TWO** enclosures.

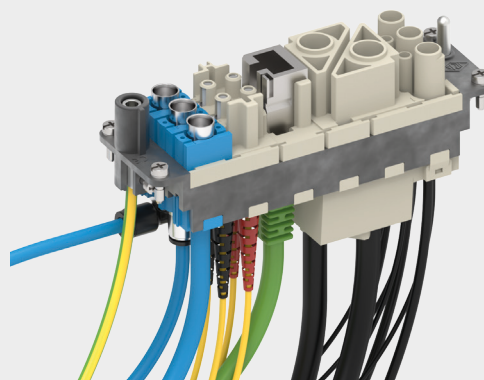

CX 01 T
1 module



CX 02 TF/ TM
2 modules

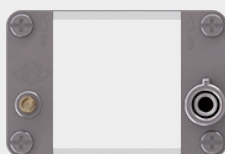

CX 04 TF/ TM
4 modules

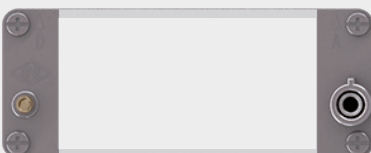

CX 03 TF/ TM
3 modules

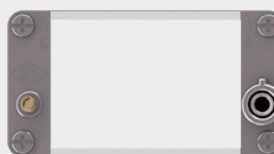

CX 06 TF/ TM
6 modules

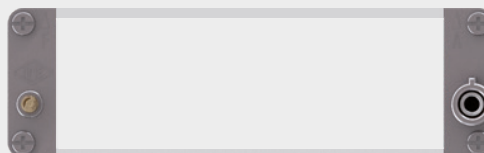

Possibility – to be verified case-by-case – to use the recently added MIXO **HNM frames** (provided with special gold plated PE contacts) together with R series of crimp contacts and the relevant connector hoods and housings, to produce, where required, an **HNM connector** (High Number of Matings, up to 10 000 cycles of operation).

Fill the unused frame slots with CX FM dummy module

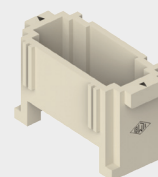

In addition, the MIXO series can be used with the **COB series panel supports**.

Frames	COB panel supports part No.
CX 02 TF/ TM	fixed: COB 06 BC and COB TCQ
	mobile: COB TSF, COB TSFS and COB 06 CMS
CX 03 TF/ TM	fixed: COB 10 BC and COB TCQ
	mobile: COB TSF, COB TSFS and COB 10 CMS

Frames	COB panel supports part No.
CX 04 TF/ TM	fixed: COB 16 BC and COB TCQ
	mobile: COB TSF, COB TSFS and COB 16 CMS
CX 06 TF/ TM	fixed: COB 24 BC and COB TCQ
	mobile: COB TSF, COB TSFS and COB 24 CMS

THE COMPLETE RANGE

2023 products are marked with the symbol **+**.

Inserts	Series	Contact type	Signal type	Kind of connection	Rated current (A)	Rated voltage (V)	Number of frame slots
+ CX 01/01B 30F/M		main	electric	crimp	300	1000	2
+ CX 01/01B 30PEF/M		PE	electric	crimp	300	—	2
+ CX 01 30AF/M		main	electric	90° screw	300	1000	2
+ CX 01 30PEAF/M		PE	electric	90° screw	300	—	2
CX 01 YF/M		main	electric	crimp	200	1000	2
CX 01 YPEF/M		PE	electric	crimp	200	—	2
CX 01 YAF/M		main	electric	90° screw	200	1000	2
CX 01 YPEAF/M		PE	electric	90° screw	200	—	2
CX 01 GF/M		main	electric	crimp	100	830	1
CX 02 GF/M		main	electric	crimp	100	1000	2
CX 02 7F/M		main	electric	crimp	70	1000	1
CX 02 4AF/M		main	electric	axial screw	40	1000	1
CX 02 4BF/M		main	electric	axial screw	40	1000	1
CX 02 4F/M		main	electric	crimp	40	1000	1
CX 03 4F/M		main	electric	crimp	40	400 / 690	1
CX 03 4BF/BM		main	electric	crimp	40	500	1
CX 3/4 XDF/M		main / auxiliary	electric	crimp	40 / 10	830	1
CX 04 XF/M		main	electric	crimp	40	830	1
▲ CX 05 SF/M		main	electric	spring	16	400	1
CX 05 SHF/M		main	electric	SQUICH®-spring	16	400	1
CX 06 CF/M		main	electric	crimp	16	500	1
CX 06P CF/M		main	electric	crimp	16	830	1
CX 06 CYF/M		main	electric	AXYR®-spring	16	500	1
CX 08 I6F/M		main + shield	electric	crimp	5	50	1
CX 08 I6GF/I6GM		main + shield	electric	crimp	5	50	1
RX 08 I6F/M	HNM	main + shield	electric	crimp	5	50	1
RX 08 I6GF/I6GM	HNM	main + shield	electric	crimp	5	50	1
CX 08 D5F/F2 M/M2		main + shield	electric	crimp	10	50	1
CX 08 D5GF/F2 GM/M2		main + shield	electric	crimp	10	50	1
RX 08 D5F/F2 M/M2	HNM	main + shield	electric	crimp	10	50	1
RX 08 D5GF/F2 GM/M2	HNM	main + shield	electric	crimp	10	50	1
CX 08 CYF/M		main	electric	AXYR®-spring	16	400	1
CX 20 CF/M		main	electric	crimp	16	500	2
CX 12 DF/M		main / auxiliary	electric	crimp	10	250	1
+ CX 12 DYF/M		main / auxiliary	electric	AXYR®-spring	10	250	1
CX 17 DF/M		main / auxiliary	electric	crimp	10	160	1
CX 42 DF/M		main / auxiliary	electric	crimp	10	150	2
CX 25 IBF/M		main / auxiliary	electric	crimp	4	50	1
▲ CX 25 IF/M		main / auxiliary	electric	crimp	4	50	1
CX 20S IF/M		main / auxiliary + shield	electric	crimp	4	32	1
CX 20S IGF/IGM		main / auxiliary + shield	electric	crimp	4	32	1

▲ Available upon request

Inserts	Series	Contact type	Signal type	Kind of connection	Rated current (A)	Rated voltage (V)	Number of frame slots
RX 20S IF/M	HNM	main / auxiliary + shield	electric	crimp	4	32	①
RX 20S IGF/IGM	HNM	main / auxiliary + shield	electric	crimp	4	32	①
CX 36 IF/M		main / auxiliary	electric	crimp	4	32	①
CX 02 CHF/M		main	electric	crimp	16	2500	①
CX 02 HF/M		main	electric	crimp	16	2900 / 5000	②
CX 02 4HF/M		main	electric	crimp	40	2900 / 5000	②
CX 02 BF/M		seat for two shielded connectors (refer to CX 04 B, CX 01 B, CX 01 BC, CX 08 B)					
CX 01 BCF/M		main / auxiliary + shield	electric	crimp	16	50	—
CX 01 BF/M		main / auxiliary + shield	electric	crimp	10	50	—
CX 04 BF/M		main / auxiliary + shield	electric	crimp	10	50	—
CX 08 BF/M		main / auxiliary + shield	electric	crimp	5	50	—
CX 03 P		pneumatic plastic Ø 1,6 - 3,0 - 4,0 mm	air	push-in	—	—	①
CX 02 P		pneumatic plastic Ø 6,0 mm	air	push-in	—	—	①
CX 03 MP		pneumatic metal Ø 3,0 - 4,0 - 6,0 mm	air	push-in / quick-fitting	—	—	①
+ CX 02 MPBF/M		pneumatic metal Ø 8,0 - 10,0 mm	air	push-in / quick-fitting	—	—	②
CX FM		none (dummy module)	—	—	—	—	①
CX 01 J8F/M/IM		RJ45	electric	crimp / IDC	—	—	①
CX 01 J8AIF/BIF/PIF		RJ45 + shield	electric	IDC	1	50	①
CX 01 J8UM		RJ45	electric	IDC	—	—	①
CX 01 JF/M		RJ45 + auxiliary	electric	crimp	10	250	②
CX 02 JF/M		RJ45 + auxiliary	electric	crimp	10	250	③
CX 01 UF/M		USB	electric	—	—	—	①
CX 01 9VF/M		D-SUB	electric	crimp	5	50	①
CX 01 9VF2/M2		D-SUB + shield	electric	crimp	5	50	①
CX 01 9VTF		D-SUB	electric	screw	5	50	①
CX 01 MIF/MIM		HDMI	electric	—	—	—	①
CX 04 LF/M		POF / MOST	optic	crimp	—	—	①
CX 04 RF/M		coaxial	electric	crimp	—	—	①
CX 04 SCF/M		SC fibre optic	optic	crimp / glue	—	—	①

Calculate the number of frame slots taken up by the required inserts (frame slot 1, 2 or 3 modules) and select the right frame according to the number of required modules (available 1, 2, 3, 4 and 6 modules).

Single sized modules, where specified, can also be installed directly inside **MIXO ONE** and **MIXO TWO** enclosures.



TECHNICAL CHARACTERISTICS

- 1 Pneumatic contacts in metal (or plastic) with hose barb or quick-fitting connection.
- 2 Fibre optic contacts SC type.
- 3 Electric contacts in silver-plated or gold-plated brass with connections to the conductors via crimping, spring clamp or axial screw.
- 4 Modular inserts of identical size with insertion system for forming the complete module and frame lock tab.
- 5 Inserts in self-extinguishing thermoplastic material, reinforced with glass fibre, UL 94V-0 approved, with a working temperature range of -40 °C to +125 °C (unless otherwise declared).
- 6 Inserts in conformance with the requirements of the EN 61984 standard and certified and marked with the UL, CSA (where applicable), CQC, DNV, BV, EAC (where applicable) marks.
- 7 Inserts with patented "swallowtails" to prevent incorrect coupling.
- 8 Position of contacts identified with numbers or codes on both sides of every insert.
- 9 Male/female module carrier frames with mandatory housings and polarity, in die-cast zinc alloy.
- 10 Module lock tab, may be divided according to the number of modules used; it guarantees a perfect stability of the modules during wiring and coupling/uncoupling of the connectors.
- 11 Asymmetric protective earth contacts (two per frame) with wide contact surface to prevent incorrect coupling; when two or more identical connectors of the MIXO series are used, coded pins may prevent incorrect coupling.
- 12 Captive frame fastening screws, with spring washer.
- 13 Dummy module for unused frame slots.

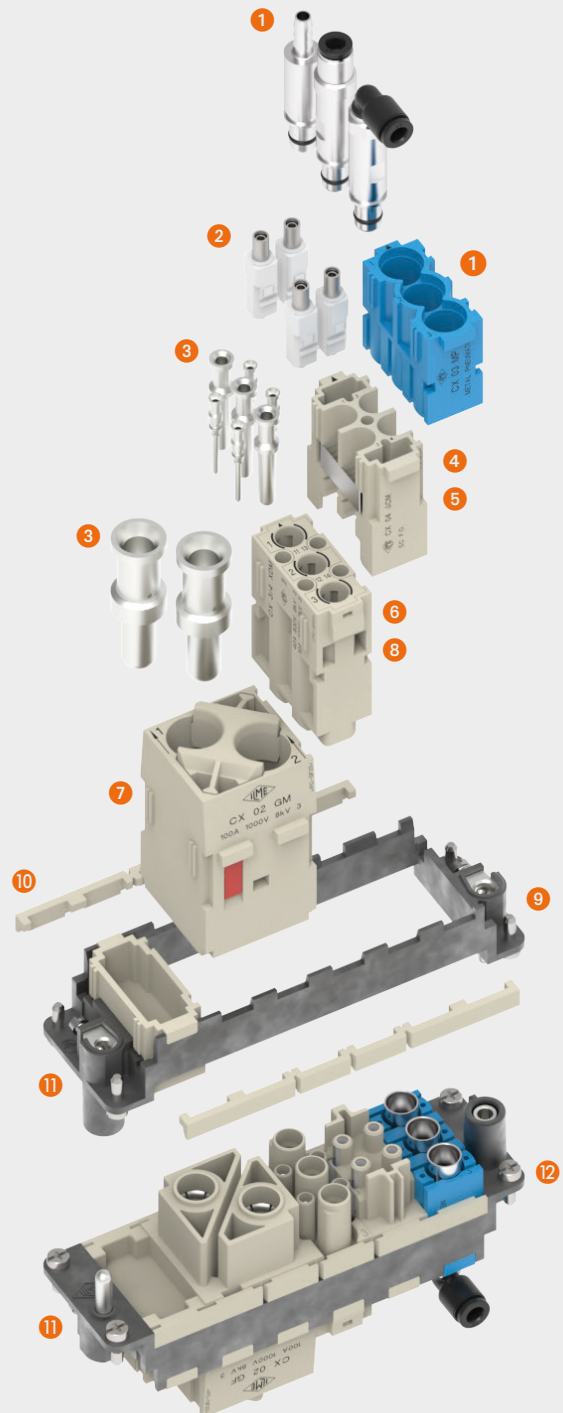

ADVANTAGES

- ☑ Easy and user-friendly assembly of the complete multi-module insert before fixing it on the relevant sized metal frame;
- ☑ use of proprietary ILME technology providing each module with "swallowtails" (lateral keys/keyways), for reciprocal locking of modules and overall assembly of the insert into rigid (non hinged) frames with snap-in locking strips;
- ☑ faster and easier assembly compared with competitor solutions (easier handling of modules as a complete block than e.g. 6 independent parts);
- ☑ intermateability at "complete connector" (modules in frame) with other industry standard products;
- ☑ robust and long lasting prevailing crimp connection technology (largely preferred over screw type technology in high vibration and shock environments).



Watch our
MIXO series Video

MIXO SERIES AT A GLANCE

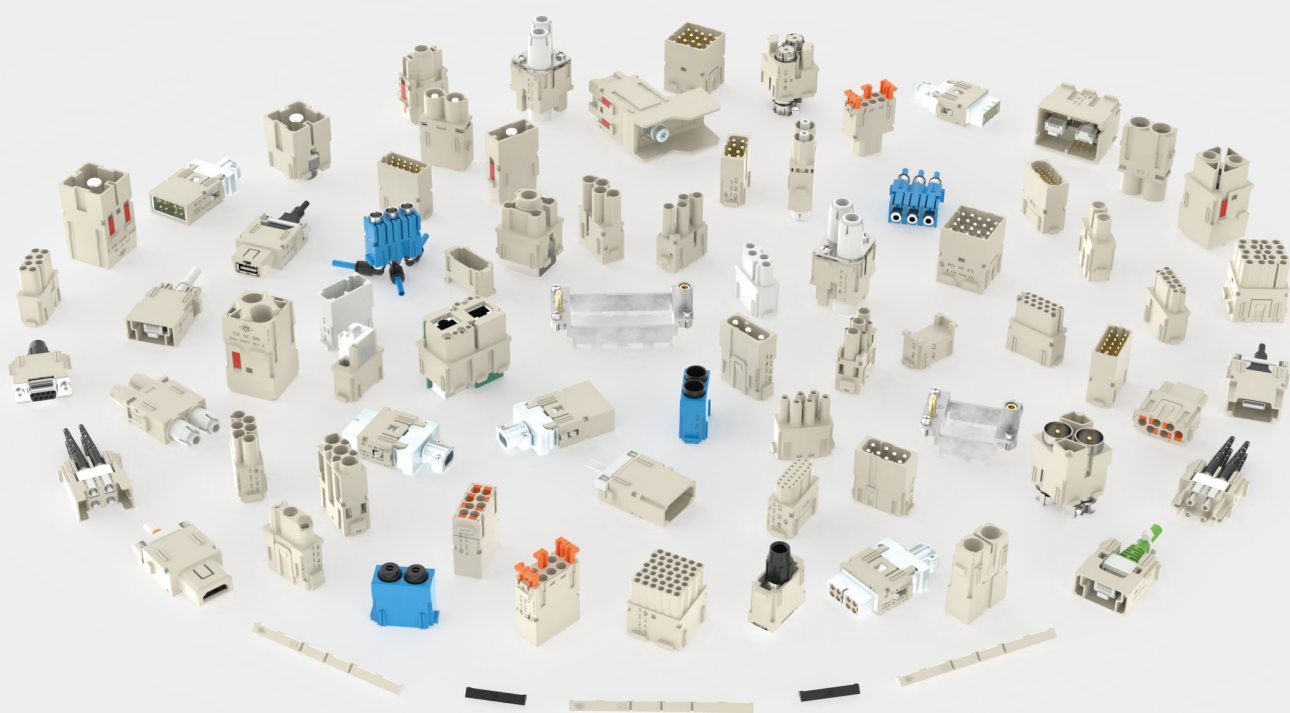

MIXO CX 12 DYF /M

New 10 A MIXO modules
with **AXYR®** connection technology

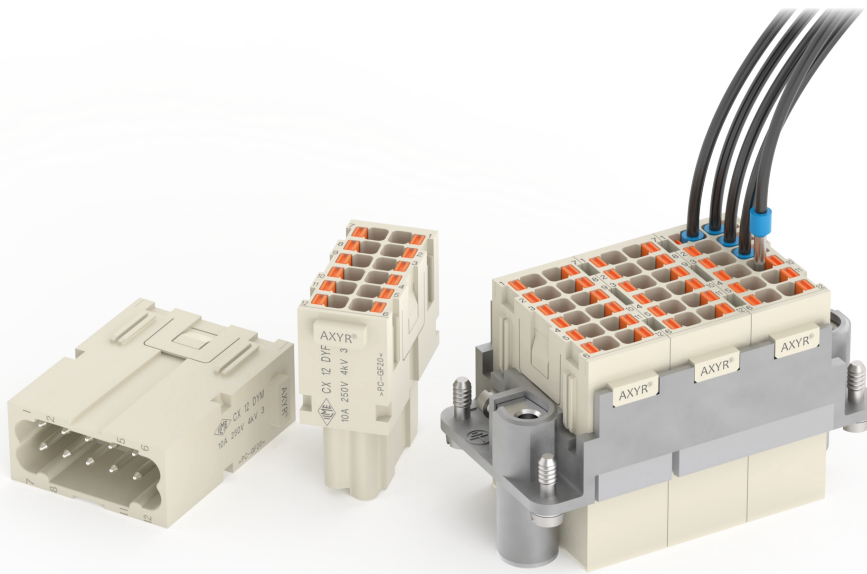

The tool-less variant of the popular crimp version CX 12 DF /M

12 P: 10 A 250 V 4 kV 3

The new 12-pole **AXYR® CX 12 DYF / M** MIXO modules are the tool-less variant of the popular crimp version CX 12 DF /M.

Implementing in the 10 A range the **AXYR®** technology (spring push-in, the actuator button being required only for release purposes or for wiring with stranded copper wires or ferruled or solid wires with CSA < 0,75 mm² / 18 AWG), these inserts cover with one size the whole wire ranges:

Q **0,14 mm² to 1,5 mm² (AWG 26-16)** for ferruled (prepared) flexible copper wires;

Q **0,14 mm² to 2,5 mm² (AWG 24-14)** for unferruled (unprepared) solid or flexible copper wires;

without need for additional crimping tools.

While crimping is a special process requiring skill, the **AXYR®** technology, being so simple, is virtually skill-independent and provides tool-less connection for contact densities that the SQUICH® technology cannot achieve even in its most compact version.

Q Current-temperature derating diagrams (current-carrying capacity curves) for the **CX 12 DYF / M AXYR®** module are like those of the equivalent CX 12 DF /M crimp version for the same wiring.

Q Conductors stripping length: 9..11 mm.

Q Silver plated contacts.

Q Max diameter of wire sheathing or ferrule funnel:
ø 3,8 mm (unprepared wire size 2,5 mm² / AWG 14 or ferruled wire size 1,5 mm² / AWG 16)

✓ CERTIFICATIONS

- cURus, CQC, DNV, BV, EAC pending.
- **CE** and **UKCA** markings.
- **RoHS:** compliant with exemption **6(c)**.

CX 12 DY 12 poles 10 A – 250 V

The modular inserts must be installed in suitable frames, which are then mounted in traditional enclosures* or in COB panel supports

Single-sized modular units may be directly mounted inside MIXO ONE and MIXO TWO enclosures

page:

frames for modular units
MIXO ONE enclosures

316 - 317
369

page:

MIXO TWO enclosures

76, 77

refer to CN.19 pages

modular units,
AXYR® terminal connections

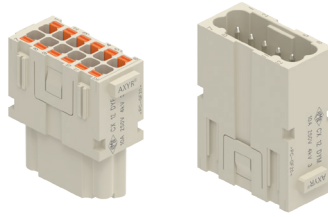

Q SILVER PLATED CONTACTS

FROM NOVEMBER 2023

description

part No.

spring/AXYR® push-in connection
female insert with female contacts
male insert with male contacts

[CX 12 DYF](#)
[CX 12 DYM](#)

- characteristics according to EN 61984:
10 A 250 V 4 kV 3

- cURus (ECBT2/8 and PVVA2/8) pending
- CQC, DNV, BV, EAC pending

- rated voltage according to UL/CSA: 600 V
- insulation resistance: $\geq 10 \text{ G}\Omega$
- ambient temperature limit: $-40 \text{ }^\circ\text{C} \dots +125 \text{ }^\circ\text{C}$
- made of self-extinguishing thermoplastic resin UL 94V-0
- mechanical life: ≥ 500 cycles
- contact resistance: $\leq 3 \text{ m}\Omega$
- max diameter of wire sheathing or ferrule funnel:
 $\varnothing 3,8 \text{ mm}$ (unprepared wire size $2,5 \text{ mm}^2$ / AWG 14
or ferruled wire size $1,5 \text{ mm}^2$ / AWG 16)

- for max. current load see the connector inserts derating diagram below; for more information see page 28 of CN.19 catalogue.

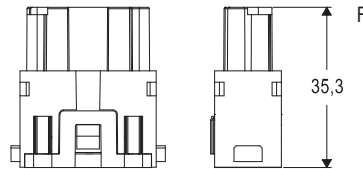
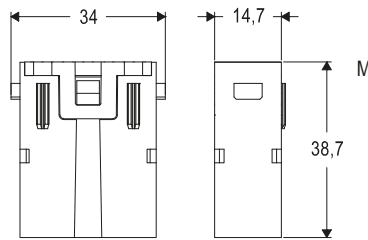

contacts side (front view)
side with reference arrow ▲

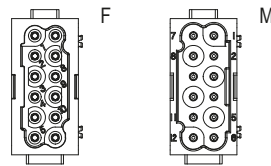

Q Please refer to page 21 for the AXYR® range

CX 12 DY, 12 poles connector inserts
Maximum current load derating diagram

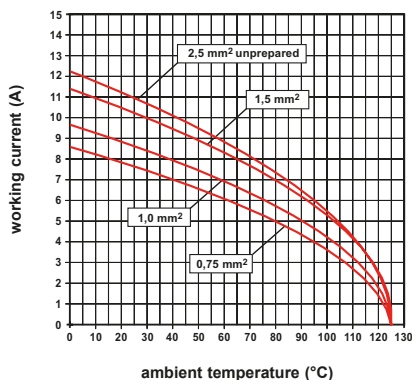

inserts for conductors with the following cross-sectional areas:

- unprepared conductor
0,14 mm² - 2,5 mm² (AWG 26-14)
- prepared conductor with crimped end-sleeve
0,14 mm² - 1,5 mm² (AWG 26-16)
- conductors stripping length: 9..11 mm

MIXO 300 A modules and crimp contacts

Line modules: CX 01 30 (16..70 mm²) and CX 01B 30 (95, 120 mm²)

PE modules: CX 01 30PE (16..70 mm²) and CX 01B 30PE (95, 120 mm²)

Crimp contacts: C30 series of sizes 16, 25, 35, 50, 70, 95 and 120

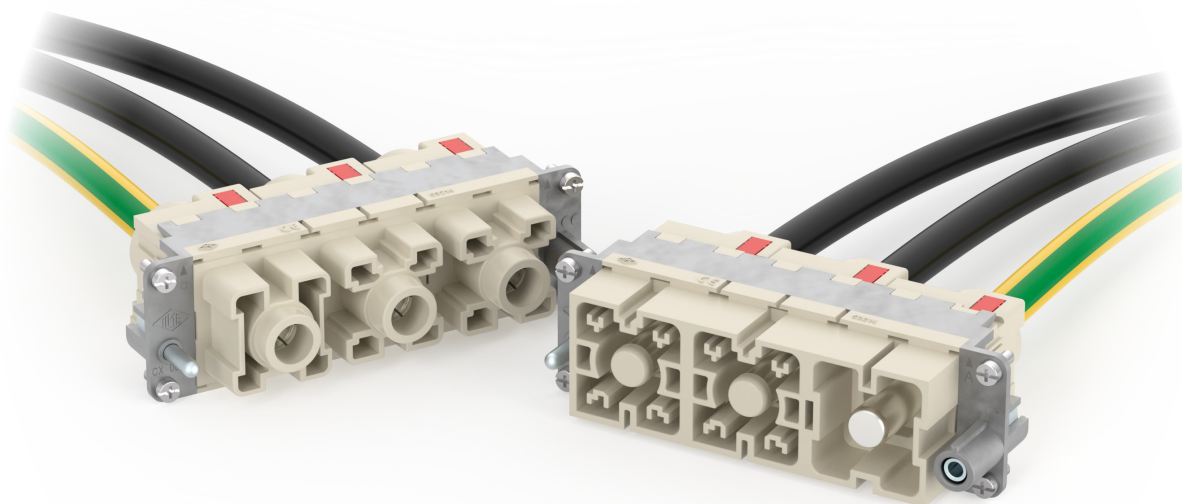

MIXO CX 01 30 and CX 01B 30, line modules

1 P: 300 A 1000 V 8 kV 3 – 1300 V_{DC}

MIXO CX 01 30PE and CX 01B 30PE, PE modules

1 P: 300 A



Find out more
www.ilme.com

TECHNICAL FEATURES



Watch our technical clip

The requirements to increase **up to 300 A** the current loading of the available MIXO 200 A CX 01 Y connector modules, with the necessity to fit in the same size the required **larger wires** (95 mm² and 120 mm²), while at the same time keeping the possibility to use such module with the range of sizes of the MIXO 200 A modules, led to a complete overhaul of the solution.

This resulted in the necessity of splitting the wider wire range into two separate sizes of module, due to the need to differentiate the rear contact holding part to accommodate different wire sheathing diameters and to retain contacts with remarkably different barrel size, and required the **development of a new wider series of crimp contacts**, with the need for **more powerful crimp tools**.

Given the different size of the dedicated new **C30 series crimp contacts**, which also include **protected male contacts**, i.e., male contacts with insulating tip that provide **finger proof safety** to said male connector modules, two sizes of module are foreseen for the *line version* and two sizes for the *PE version*. The new MIXO 2-slot-sized connector modules for the **new C30 series crimp contacts** are available in two sizes:

- Q **01** (regular), for use with **new series C30 crimp contacts** of sizes 16, 25, 35, 50 and 70;
- Q **01B** (large), for use with **new series C30 crimp contacts** of larger sizes 95 and 120.

The two sizes thus cover different ranges of wiring, and each one is available in **line version** (insulated) and in **PE version** (where a reliable bonding contact between the power PE crimp contact and the metal MIXO frame is made possible), for a total of 4 different male modules and 4 different female modules, for use with the **new series C30 crimp contacts**.

Together, they widen the range of cross-sectional areas that the previously available MIXO 200 A (line modules CX 01 Y and PE modules CX 01 YPE) enabled, to include also the new sizes 95 mm² and 120 mm², AWG 3/0 and 4/0, thus allowing an increase of current-carrying capacity of these modules up to 300 A in the same size.

- Q The design of the modules allows use up to and including **1300 V_{DC}** according to the latest edition of EN IEC 60664-1:2020.
- Q **Series C30 crimp contacts** are designed to use the more popular hexagonal DIN 48084 press crimping (in use for DIN 46235 cable end-sleeves). Two dedicated crimping tools (manual hydraulic and battery operated hydraulic) are provided and described on pages 54-55.

- Q Like the previously available MIXO 200 A ones, the new 300 A modules **are made in two parts**: a modular connector insulating body and a contact holder retained in the body by red-coloured locking tabs (proprietary technology); however, the new modules **are provided fully assembled**, as contact holding function is provided by elastic tongues in the contact holder that allow the insertion of the crimped connection without need for removing the contact holder.
- Q The contact holders of the “01” and the “01B” differ in that the shroud necessary for maintaining creepage distances, thus embracing the wire sheathing and the crimp barrel used by the crimped connection needs to be larger in the “01B” size (95 mm²..120 mm², AWG 3/0..4/0) than in the “01” size (16 mm²..70 mm², AWG 6..2/0) wire range. To avoid mistakes, the two module sizes are duly marked with the relevant size range of corresponding C30 crimp contacts.
- Q The **CX 01 30M** and **CX 01B 30M** male inserts' mating face is provided with suitable insulating prongs, so that, when used in combination with the finger proof crimp male contacts series C30 (C30MA 16 P through C30MA 120 P, see page 43), they result in finger proof male connectors. This feature is new compared to the previously available MIXO 200 A modules and crimp contacts series CY.
- NOTE – This additional safety feature is particularly useful to avoid electric shock whenever hazardous voltage may be still present for a certain period (e.g., due to discharge of capacitors) on the male side of the connection after disconnection.
- Q Current-temperature derating diagrams (current-carrying capacity curves) for **CX 01 30** module are like those of the equivalent CX 01 Y 200 A crimp versions (same wiring range). For **CX 01B 30** module, covering the larger wire sizes 95 mm² and 120 mm², AWG 3/0 and 4/0, new diagrams are under development to cover the extended range up to 300 A.
- Q Conductors stripping length: see **series C30 crimp contacts** pages.
- Q Silver plated contacts.
- Q Max diameter of wire sheathings:
 - ø 18,5 mm for size **01** modules (wire size 70 mm² / AWG 2/0)
 - ø 22,4 mm for size **01B** modules (wire size 120 mm² / AWG 4/0)

⇨ CERTIFICATIONS

- cURus, CQC, DNV, BV, EAC pending.
- **CE** and **UK CA** markings.
- **RoHS**:
 - modular inserts: compliant;
 - series C30 crimp contacts: compliant with exemption 6(c).

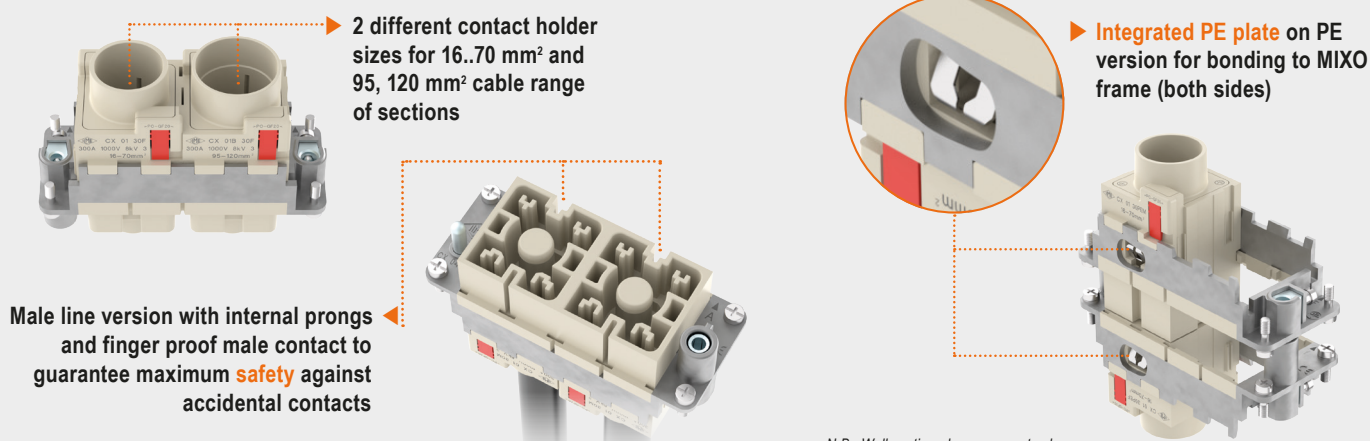

N.B.: Wall sectioned on purpose to show the PE contact between PE plate and MIXO frame.

CX 01 30F/30M – CX 01B 30F/30M 1 pole 300 A – 1000 V – 1300 V_{DC}

The modular inserts must be installed in suitable frames, which are then mounted in traditional enclosures* or in COB panel supports

page:

frames for modular units*

317

* enclosures: housings or high construction hoods

refer to CN.19 pages

modular units, crimp connections
16...70 mm²

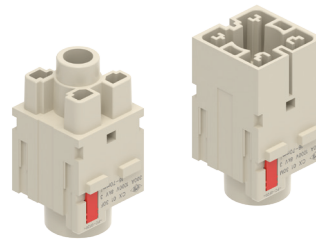

FROM JUNE 2023

modular units, crimp connections
95, 120 mm²

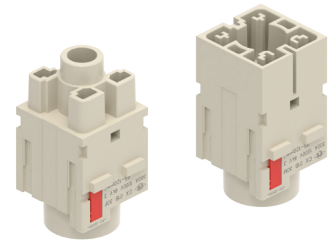

FROM JUNE 2023

description

part No.

part No.

without contacts (to be ordered separately)
female insert for female contacts (16...70 mm²)
male insert for male contacts (16...70 mm²)

[CX 01 30F](#)
[CX 01 30M](#)

without contacts (to be ordered separately)
female insert for female contacts (95, 120 mm²)
male insert for female contacts (95, 120 mm²)

[CX 01B 30F](#)
[CX 01B 30M](#)

- characteristics according to EN 61984:
300 A 1000 V 8 kV 3 – 1300 V_{DC}
300 A 920/1600 V 8 kV 2

- cURus (ECBT2/8 and PVVA2/8) pending
- CQC, DNV, BV, EAC pending

- rated voltage according to UL/CSA: 600 V
- insulation resistance: ≥ 10 GΩ
- ambient temperature limit: -40 °C ... +125 °C
- made of self-extinguishing thermoplastic resin UL 94V-0
- mechanical life: ≥ 500 cycles
- contact resistance: ≤ 0,2 mΩ
- Max diameter of wire sheathings:
- ø 18,5 mm for size 01 modules (wire size 70 mm² / AWG 2/0)
- ø 22,4 mm for size 01B modules (wire size 120 mm² / AWG 4/0)

- for max. current load see the connector inserts derating diagram under construction; for more information see page 28 of CN.19 catalogue.

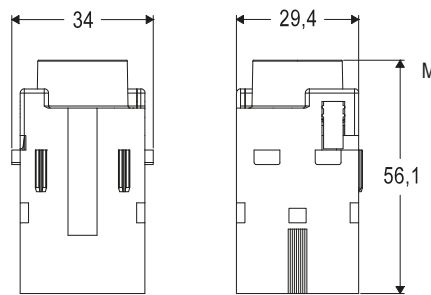

contacts side (front view)
side with reference arrow ▲

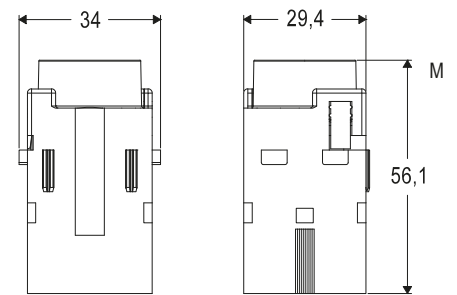
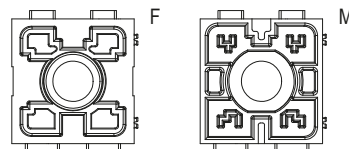

contacts side (front view)
side with reference arrow ▲

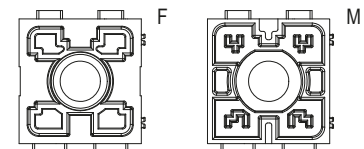

300 A silver plated crimp contacts



FROM JUNE 2023

description

part No.

300 A female crimp contacts

16 mm ²	AWG 6
25 mm ²	AWG 4
35 mm ²	AWG 2
50 mm ²	AWG 1
70 mm ²	AWG 2/0
95 mm ²	AWG 3/0
120 mm ²	AWG 4/0

C30FA 16
C30FA 25
C30FA 35
C30FA 50
C30FA 70
C30FA 95
C30FA 120

silver plated

300 A male finger proof crimp contacts

16 mm ²	AWG 6
25 mm ²	AWG 4
35 mm ²	AWG 2
50 mm ²	AWG 1
70 mm ²	AWG 2/0
95 mm ²	AWG 3/0
120 mm ²	AWG 4/0

C30MA 16 P
C30MA 25 P
C30MA 35 P
C30MA 50 P
C30MA 70 P
C30MA 95 P
C30MA 120 P

- it is recommended to crimp the contacts with crimping tools homologated by ILME (please see the crimping tool section for 300 A contacts, C30FA, C30MA series at pages 54-55).

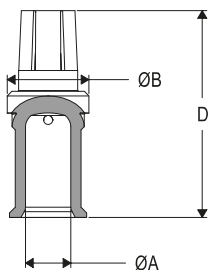
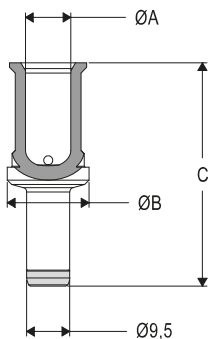

C30FA and C30MA..P contacts

conductor section (mm ²)	conductor slot ø A (mm)	ø B (mm)	C (mm)	D (mm)	conductor stripping length (mm)
16	5,5	18	42,7	39,1	19
25	7	18	42,7	39,1	19
35	8,2	18	43,7	40,1	20
50	10	18	49,2	45,6	22,5
70	11,5	18	49,2	45,6	22,5
95	13,5	21	49,2	45,6	22,5
120	15,5	21	49,2	45,6	22,5

CX 01 30PEF/30PEM – CX 01B 30PEF/30PEM 1 pole 300 A

The modular inserts must be installed in suitable frames, which are then mounted in traditional enclosures* or in COB panel supports

page: 317

frames for modular units*

* enclosures: housings or high construction hoods

refer to CN.19 pages

modular units, crimp connections
PE module for earth termination,
16...70 mm²

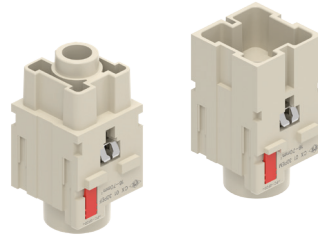

FROM JUNE 2023

modular units, crimp connections
PE module for earth termination,
95, 120 mm²

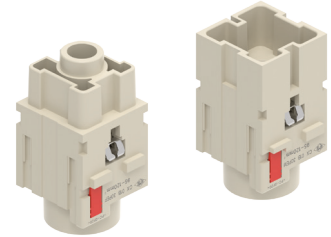

FROM JUNE 2023

description

part No.

part No.

without contacts (to be ordered separately)
PE female insert for female contacts (16...70 mm²)
PE male insert for male contacts (16...70 mm²)

[CX 01 30PEF](#)
[CX 01 30PEM](#)

without contacts (to be ordered separately)
PE female insert for female contacts (95, 120 mm²)
PE male insert for male contacts (95, 120 mm²)

[CX 01B 30PEF](#)
[CX 01B 30PEM](#)

- cURus (ECBT2/8 and PVVA2/8) pending
- CQC, DNV, BV, EAC pending
- ambient temperature limit: -40 °C ... +125 °C
- made of self-extinguishing thermoplastic resin UL 94V-0
- mechanical life: ≥ 500 cycles
- contact resistance: ≤ 0,2 mΩ
- Max diameter of wire sheathings:
 - ø 18,5 mm for size 01 modules (wire size 70 mm² / AWG 2/0)
 - ø 22,4 mm for size 01B modules (wire size 120 mm² / AWG 4/0)

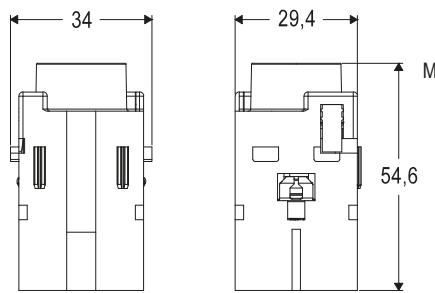

contacts side (front view)
side with reference arrow ▲

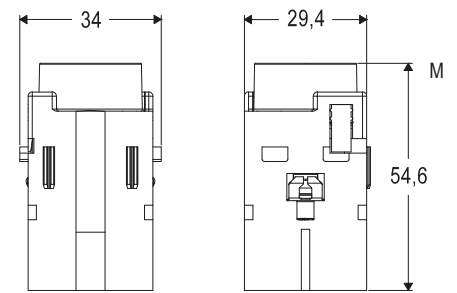
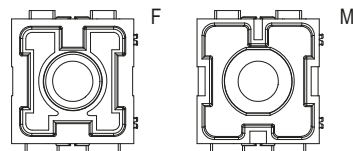

contacts side (front view)
side with reference arrow ▲

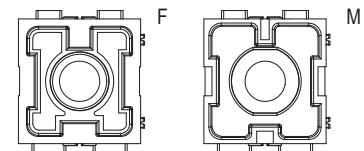

300 A silver plated crimp contacts



FROM JUNE 2023

description

part No.

300 A female crimp contacts

16 mm ²	AWG 6
25 mm ²	AWG 4
35 mm ²	AWG 2
50 mm ²	AWG 1
70 mm ²	AWG 2/0
95 mm ²	AWG 3/0
120 mm ²	AWG 4/0

C30FA 16
C30FA 25
C30FA 35
C30FA 50
C30FA 70
C30FA 95
C30FA 120

silver plated

300 A male crimp contacts

16 mm ²	AWG 6
25 mm ²	AWG 4
35 mm ²	AWG 2
50 mm ²	AWG 1
70 mm ²	AWG 2/0
95 mm ²	AWG 3/0
120 mm ²	AWG 4/0

C30MA 16
C30MA 25
C30MA 35
C30MA 50
C30MA 70
C30MA 95
C30MA 120

- it is recommended to crimp the contacts with crimping tools homologated by ILME (please see the crimping tool section for 300 A contacts, C30FA, C30MA series at pages 54-55).

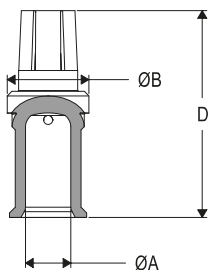
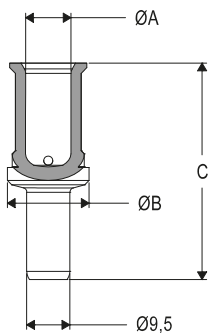

C30FA and C30MA contacts

conductor section (mm ²)	conductor slot ø A (mm)	ø B (mm)	C (mm)	D (mm)	conductor stripping length (mm)
16	5,5	18	41,2	39,1	19
25	7	18	41,2	39,1	19
35	8,2	18	42,2	40,1	20
50	10	18	47,7	45,6	22,5
70	11,5	18	47,7	45,6	22,5
95	13,5	21	47,7	45,6	22,5
120	15,5	21	47,7	45,6	22,5

ASSEMBLY INSTRUCTIONS

CX 01/01B 30 – MIXO 300 A MODULE

CONTACT INSERTION

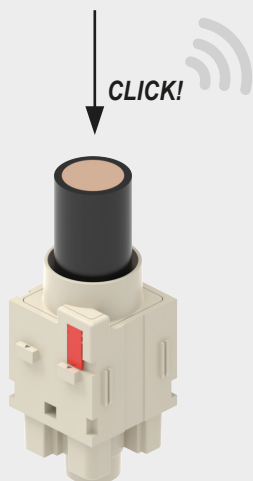
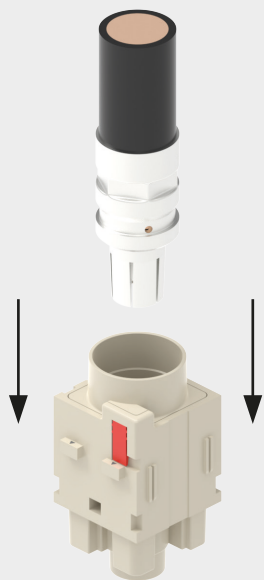

CONTACT REMOVAL

1

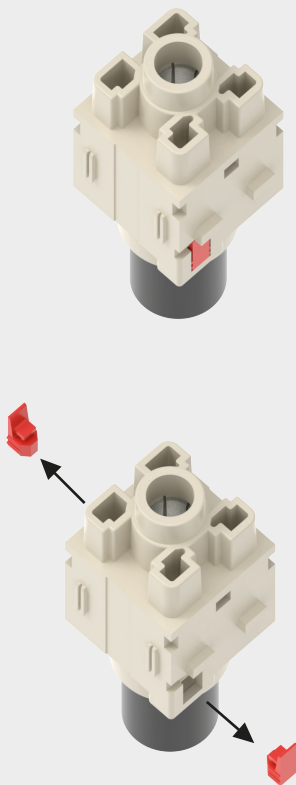

2

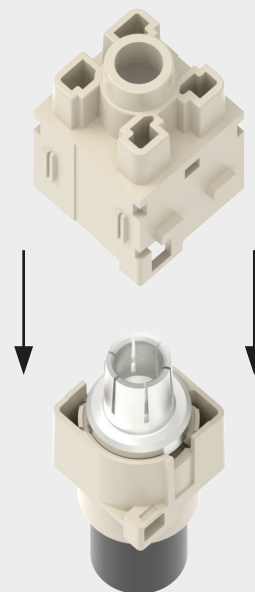

3

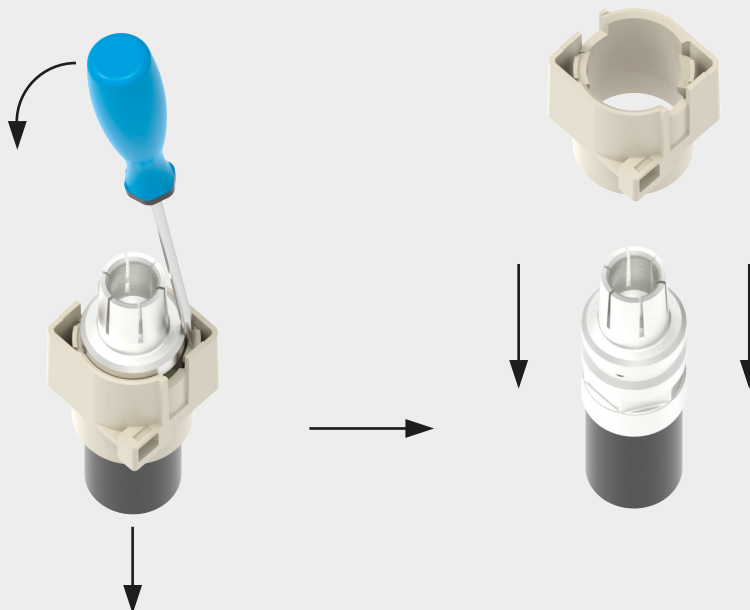

ASSEMBLY INSTRUCTIONS

CX 01/01B 30PE – MIXO 300 A PE MODULE

CONTACT INSERTION

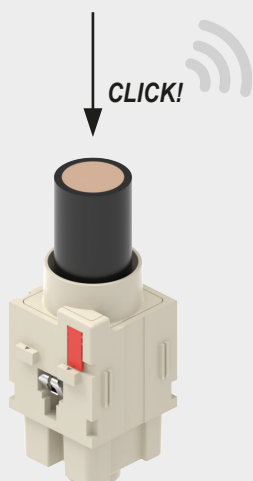
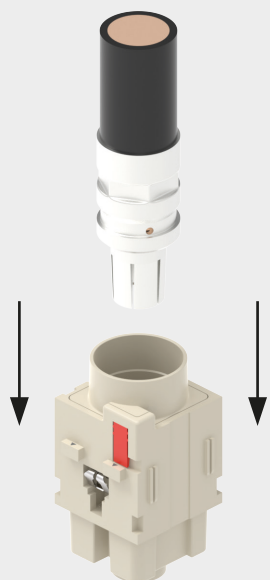

CONTACT REMOVAL

1

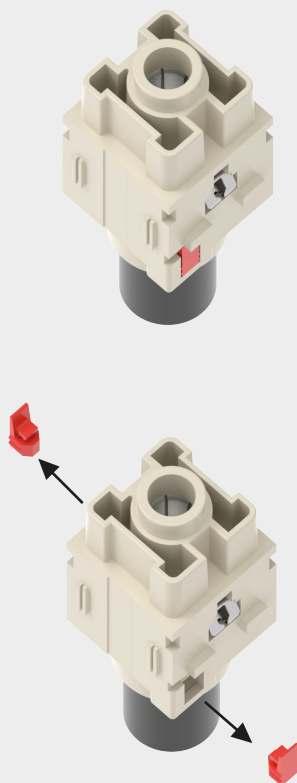

2

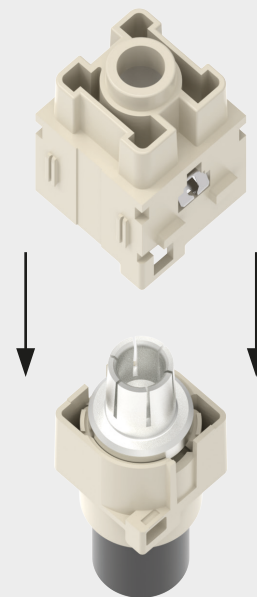

3

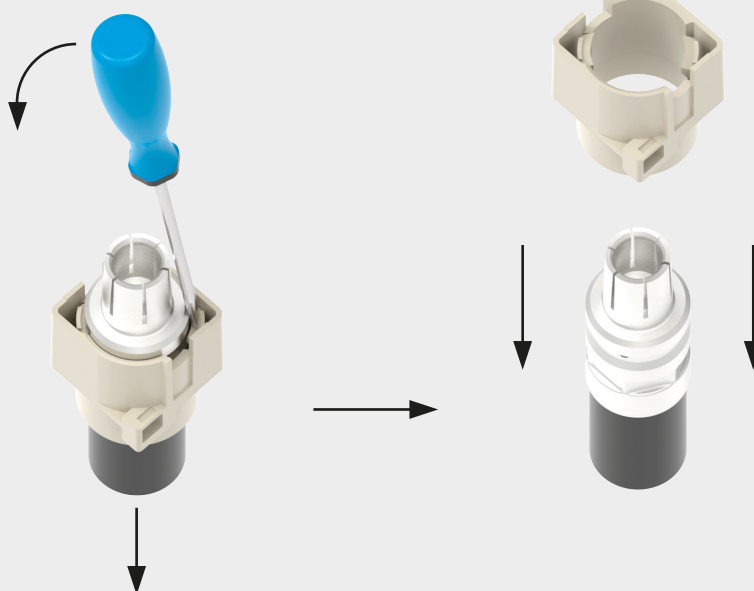

MIXO 300 A modules

For 90°-angled screw terminal connection

Line modules: CX 01 30A (16..120 mm²)

PE modules: CX 01 30PEA (16..120 mm²)

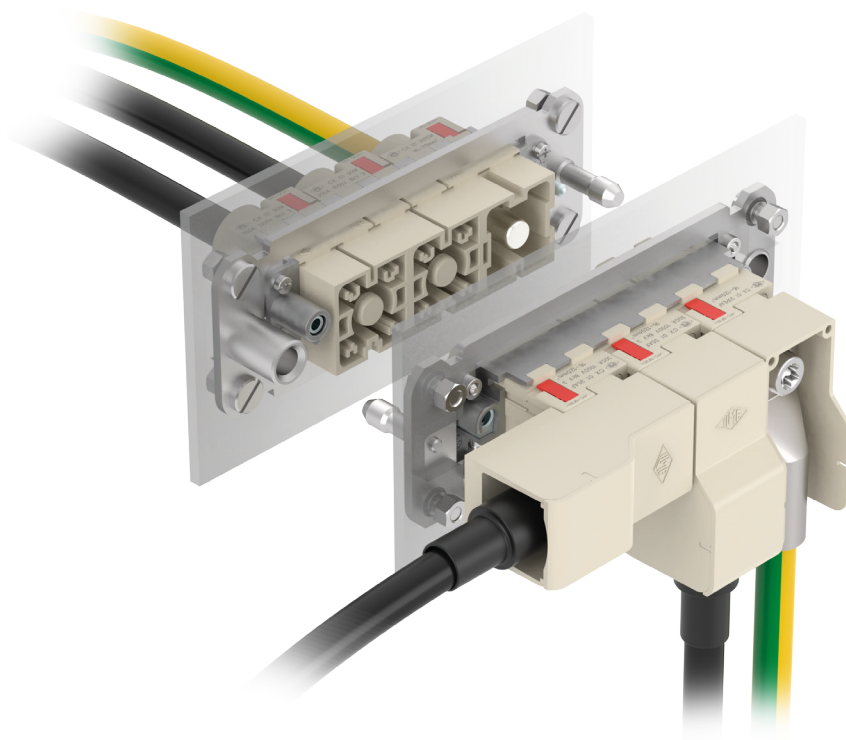

MIXO CX 01 30 A line modules

1 P: 300 A 1000 V 8 kV 3 – 1300 V_{DC}

MIXO CX 01 30PEA, PE modules

1 P: 300 A



Find out more
www.ilme.com

TECHNICAL FEATURES

High-power modules in the 70 A – 300 A current range relate to conductors with large wire-cross-section, even up to 120 mm². Such wires are often difficult to handle, having reduced bending radius and requiring an adequate installation room, often not available.

The new **MIXO CX 01 30A** line module and **CX 01 30PEA** PE module are the solution introduced by ILME to widen the potential of the MIXO high-current series, modules with the same compatible electrical rating and mating interface of the 300 A crimp version described in the previous pages but designed to **minimize its space installation requirements**.

Q The male and female contacts for the angled 300 A module allow the **connection of DIN 46235** pre-insulated crimp cable lugs (using M8 TORX® T45 screw), available on the market in the dimension for wire cross-sectional areas of 10, 16, 25, 35, 50, 70, 95 and 120 mm².

Q To keep the proper electrical insulation, ILME designed a **special insulating cover plate**, avoiding accidental contact between cable lugs of adjacent modules and saving the **nominal voltage rating of 1000 V and 1300 V_{DC}** planned for the 300 A modules.

This cover plate has been furtherly improved compared with the previously available 200 A 90°-angled module CX 01 YAF/ M, in that it now includes a further snap-in closing cap, that prevent touch with live parts inside a cabinet previously demanded to the assembler of the distribution panel.

Q The **300 A angled module** can be used inside the ILME bulkhead mounting housings as a natural extension of a busbar connection or for powering control cabinets, HVAC systems and batteries for energy storage backup applications.

Q Line male modules **CX 01 30AM** and **CX 01B 30AM** come by default **with finger proof contact** (PE modules do not require any finger proof safety).

Q Current-temperature derating diagrams (current-carrying capacity curves) for size **CX 01 30A** line module and **CX 01 30PEA** PE module are like those of the equivalent CX 01 YA and CX 01 YPEA 200 A versions (same wiring range). For size **CX 01B 30A** and **CX 01B PEA** modules, covering the larger wire sizes 95 mm² and 120 mm² (AWG 3/0 and 4/0), new diagrams are under development to cover the extended range up to 300 A.

Q Conductors stripping length: 9..11 mm.

Q Silver plated contacts.

Q Tightening torque for TORX® T45 socket bolt for fixing the cable lug: 10 Nm.

✓ CERTIFICATIONS

- cURus, CQC, DNV, BV, EAC pending.
- CE and UKCA markings.
- RoHS: compliant with exemption 6(c).

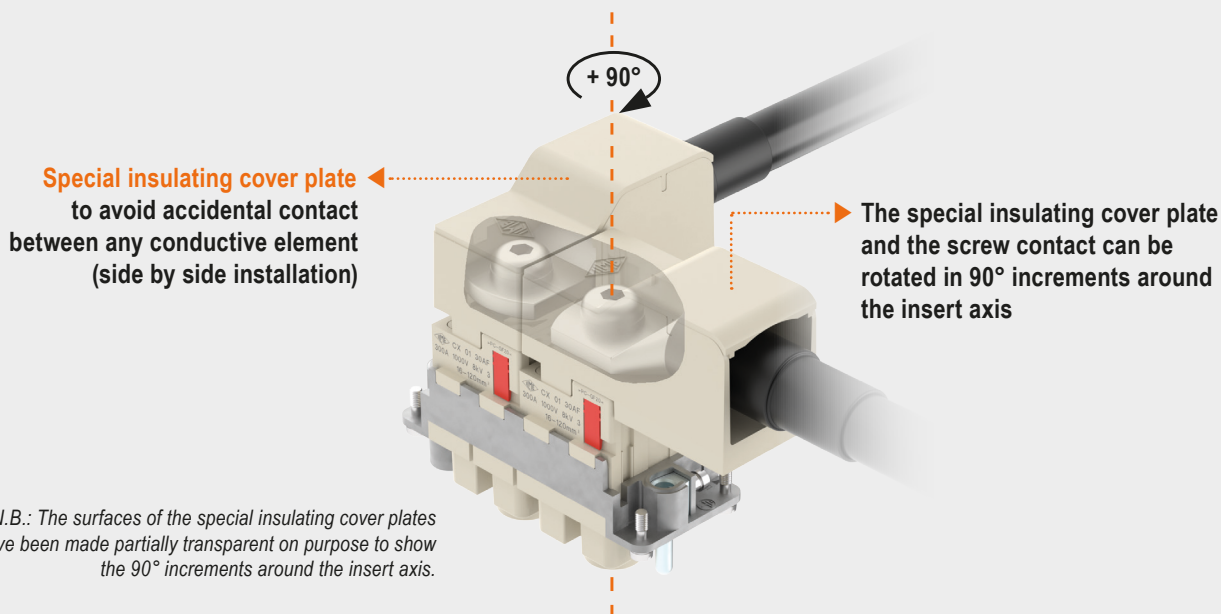

CX 01 30AF/30AM 1 pole 300 A – 1000 V – 1300 V_{DC}

The modular inserts must be installed in suitable frames, which are then mounted in traditional enclosures* or in COB panel supports

page:

frames for modular units*

317

* enclosures: bulkhead mounting housings only

1) supplied with heat-shrinking insulating tubes, to be used with tubular cable lug (not supplied)

refer to CN.19 pages

modular units, screw terminal connection

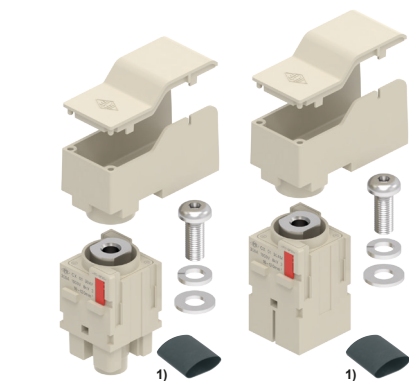

FROM JUNE 2023

description

part No.

screw terminal connection - 90° angled
female insert with female contacts
male insert with male contacts

[CX 01 30AF](#)
[CX 01 30AM](#)

- characteristics according to EN 61984:
300 A 1000 V 8 kV 3 – 1300 V_{DC}

- cURus (ECBT2/8 and PVVA2/8) pending
- CQC, DNV, BV, EAC pending

- rated voltage according to UL/CSA: 600 V
- insulation resistance: $\geq 10 \text{ G}\Omega$
- ambient temperature limit: $-40 \text{ }^\circ\text{C} \dots +125 \text{ }^\circ\text{C}$
- made of self-extinguishing thermoplastic resin UL 94V-0
- mechanical life: ≥ 500 cycles
- contact resistance: $\leq 3 \text{ m}\Omega$

- for max. current load see the connector inserts derating diagram under construction; for more information see page 28 of CN.19 catalogue.

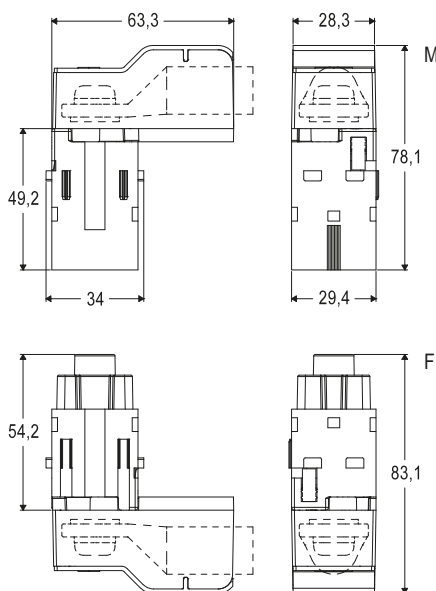

contacts side (front view)
side with reference arrow ▲

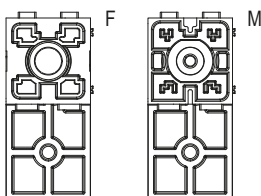

ASSEMBLY INSTRUCTIONS

CX 01 30A – MIXO 300 A 90° ANGLED MODULE

1

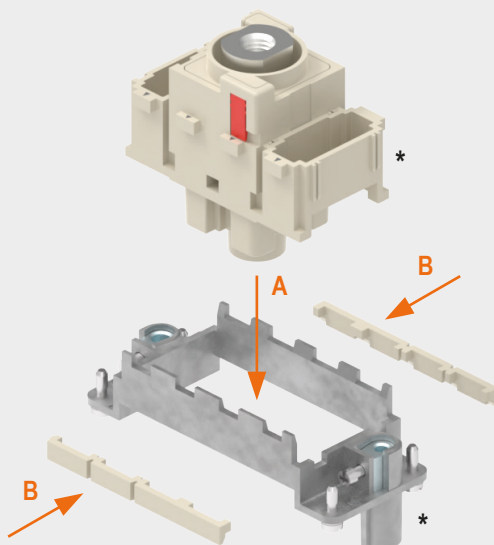

2 For bulkhead mounting housing only

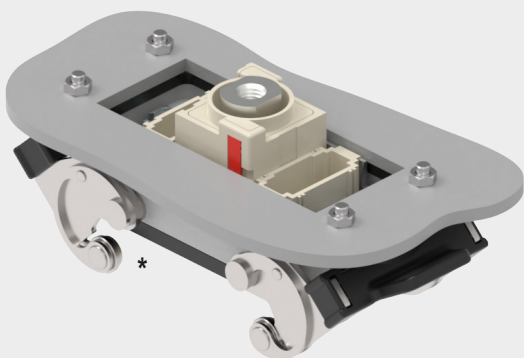

3

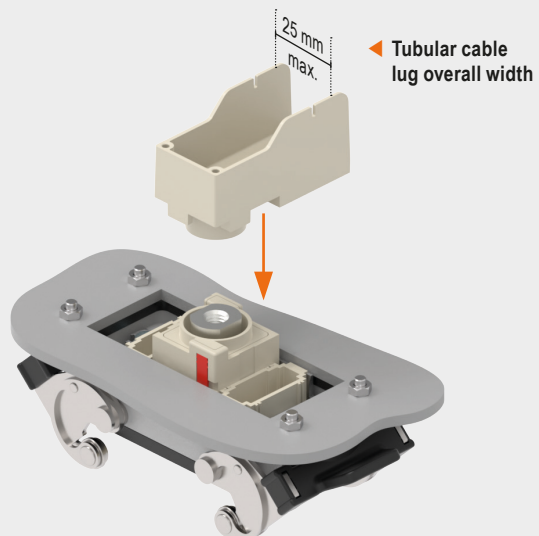

* Frame size, additional MIXO modules and housing levers may vary from those depicted

4

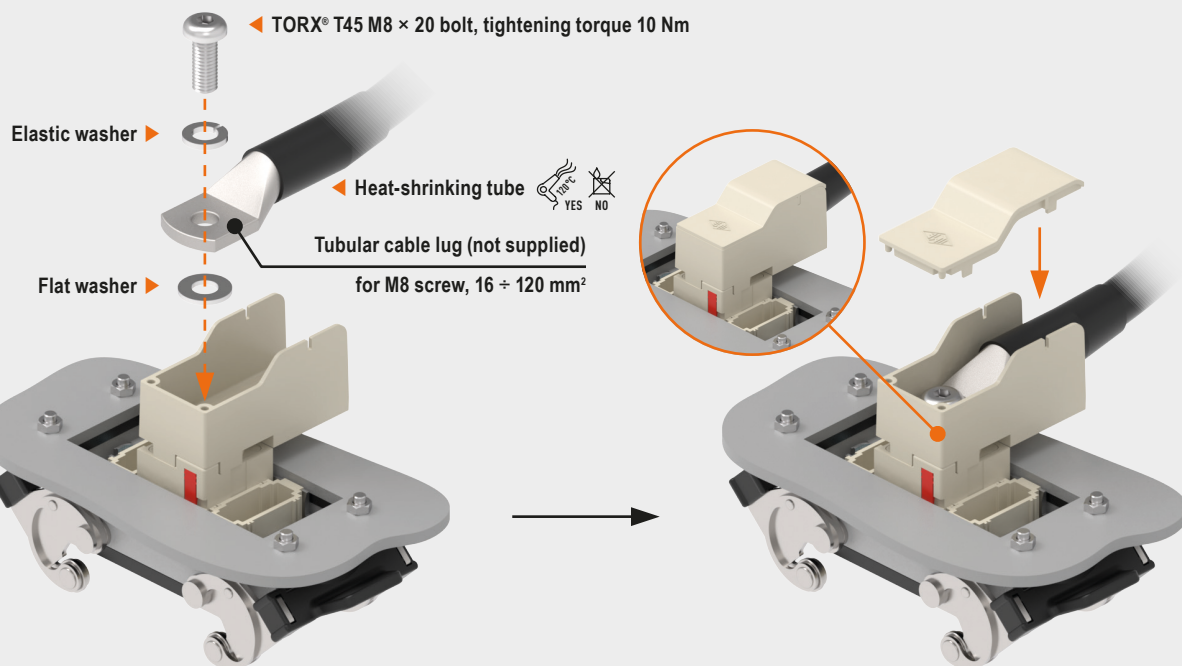

CX 01 30PEAF/30PEAM 1 pole 300 A

The modular inserts must be installed in suitable frames, which are then mounted in traditional enclosures* or in COB panel supports

page:

frames for modular units*

317

* enclosures: bulkhead mounting housings only

refer to CN.19 pages

modular units, screw PE terminal connection

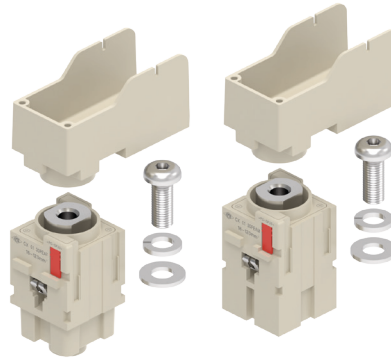

FROM JUNE 2023

description

part No.

screw terminal connection - 90° angled
PE female insert with female contacts
PE male insert with male contacts

[CX 01 30PEAF](#)
[CX 01 30PEAM](#)

- cURus (ECBT2/8 and PVVA2/8) pending
- CQC, DNV, BV, EAC pending
- ambient temperature limit: -40 °C ... +125 °C
- made of self-extinguishing thermoplastic resin UL 94V-0
- mechanical life: ≥ 500 cycles
- contact resistance: ≤ 3 mΩ

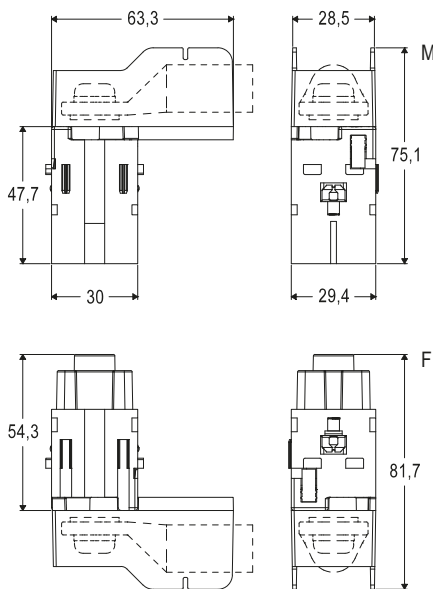

contacts side (front view)
side with reference arrow ▲

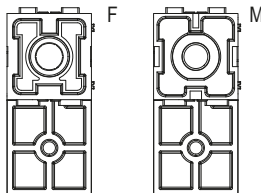

ASSEMBLY INSTRUCTIONS

CX 01 30PEA – MIXO 300 A 90° ANGLED PE MODULE

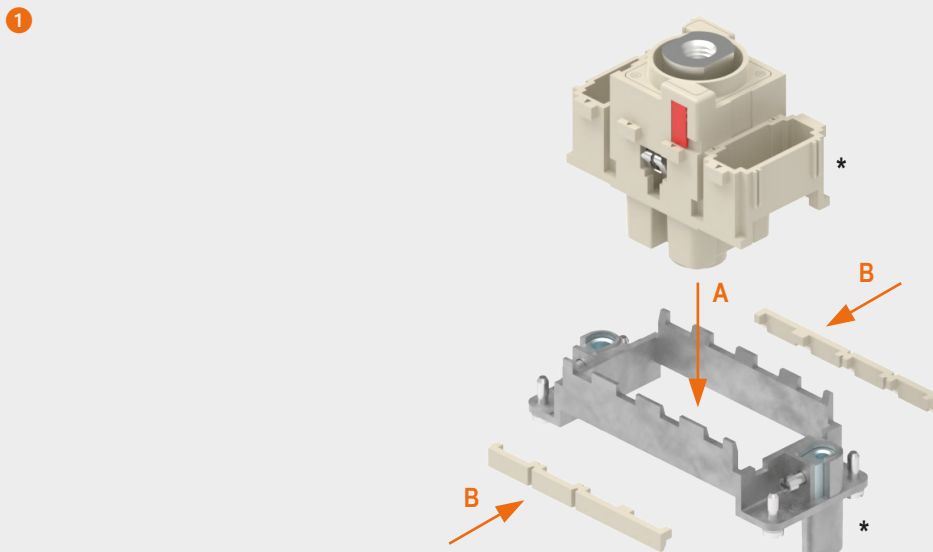

2 For bulkhead mounting housing only

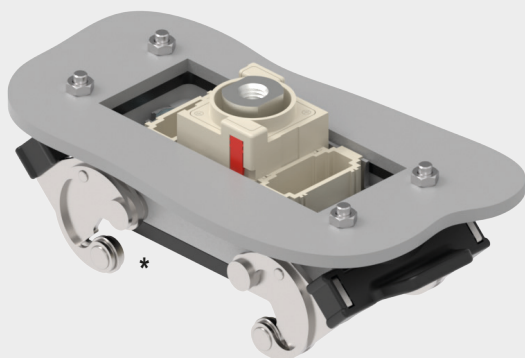

3

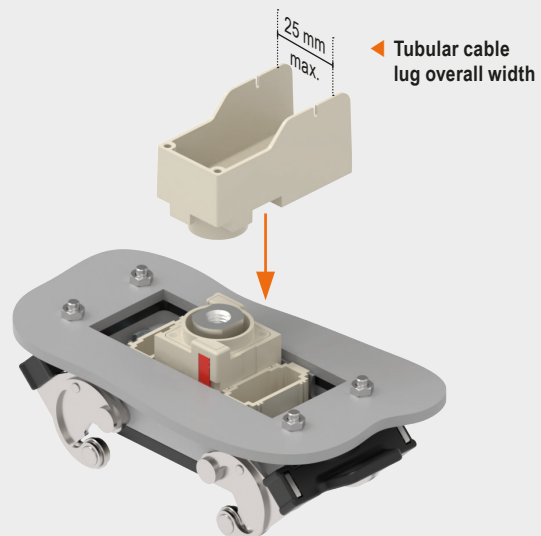

* Frame size, additional MIXO modules and housing levers may vary from those depicted

4

◀ TORX® T45 M8 × 20 bolt, tightening torque 10 Nm

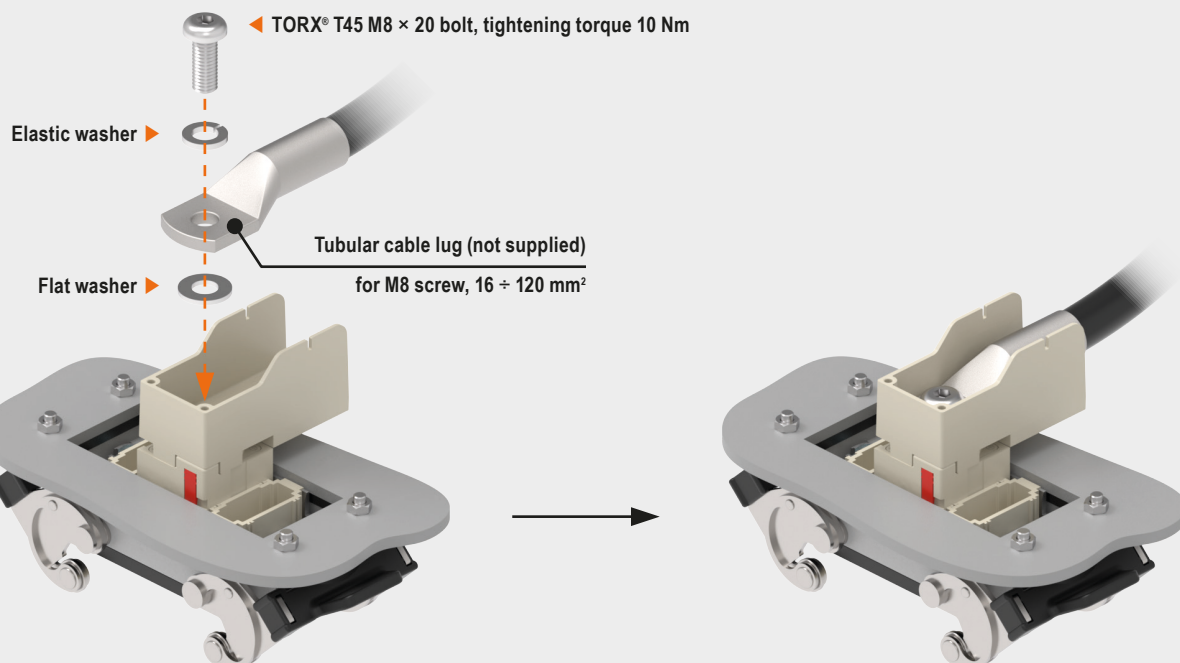

Tools and accessories for crimp contacts

For contacts of inserts series
(as applicable)

CX 01 30F/M
CX 01B 30F/M
CX 01 30PEF/M
CX 01B 30PEF/M

page:

42
42
44
44

crimping tool
manual



crimping dies



description

part No.

part No.

manual hydraulic crimping tool for **300 A**
C30 series contacts
basic tool mod. CEMBRE HT 131-C
excluding crimping dies

[C13PZ C](#)

crimping dies according to DIN 46235
for C30 contacts with 16 mm² (AWG 6) wire cross-section
for C30 contacts with 25 mm² (AWG 4) wire cross-section
for C30 contacts with 35 mm² (AWG 2) wire cross-section
for C30 contacts with 50 mm² (AWG 1) wire cross-section
for C30 contacts with 70 mm² (AWG 2/0) wire cross-section
for C30 contacts with 95 mm² (AWG 3/0) wire cross-section
for C30 contacts with 120 mm² (AWG 4/0) wire cross-section

[C13D 16 C](#)
[C13D 25 C](#)
[C13D 35 C](#)
[C13D 50 C](#)
[C13D 70 C](#)
[C13D 95 C](#)
[C13D 120 C](#)

Tool technical information

- Crimping force 135 kN
- Rated operating pressure: 700 bar
- Dimensions: 473 x 144 mm
- Weight: 5,5 kg
- Operating temperature: -15 to +50 °C

Q The tool is supplied in a case without the crimping dies.



part No.	Cembre part No.	pressing width mm	punching identification	contacts	wire cross-section	
					mm ²	AWG
C13D 16 C	MK8-C	10	MK 8	C30FA 16, C30MA 16, C30MA 16 P	16	6
C13D 25 C	MK10-C	10	MK 10	C30FA 25, C30MA 25, C30MA 25 P	25	4
C13D 35 C	MK12-C	10	MK 12	C30FA 35, C30MA 35, C30MA 35 P	35	2
C13D 50 C	MK14-C	13	MK 14	C30FA 50, C30MA 50, C30MA 50 P	50	1
C13D 70 C	MK16-C	13	MK 16	C30FA 70, C30MA 70, C30MA 70 P	70	2/0
C13D 95 C	MK18-C	14	MK 18	C30FA 95, C30MA 95, C30MA 95 P	95	3/0
C13D 120 C	MK20-C	14	MK 20	C30FA 120, C30MA 120, C30MA 120 P	120	4/0

Tools and accessories for crimp contacts

For contacts of inserts series
(as applicable)

CX 01 30F/M
CX 01B 30F/M
CX 01 30PEF/M
CX 01B 30PEF/M

page:

42
42
44
44

crimping tool
battery operated hydraulic



crimping dies



description

part No.

part No.

battery operated hydraulic crimping tool
for **300 A** C30 series contacts
basic tool mod. CEMBRE B1350-C battery charger
- for EU
- for UK
- for AUS
- for US/CAN
excluding crimping dies

C13PZ EL EU
C13PZ EL UK
C13PZ EL AU
C13PZ EL US

crimping dies according to DIN 46235
for C30 contacts with 16 mm² (AWG 6) wire cross-section
for C30 contacts with 25 mm² (AWG 4) wire cross-section
for C30 contacts with 35 mm² (AWG 2) wire cross-section
for C30 contacts with 50 mm² (AWG 1) wire cross-section
for C30 contacts with 70 mm² (AWG 2/0) wire cross-section
for C30 contacts with 95 mm² (AWG 3/0) wire cross-section
for C30 contacts with 120 mm² (AWG 4/0) wire cross-section

[C13D 16 C](#)
[C13D 25 C](#)
[C13D 35 C](#)
[C13D 50 C](#)
[C13D 70 C](#)
[C13D 95 C](#)
[C13D 120 C](#)

Tool technical information

- Crimping force 132 kN
- Minimum crimping force 152,2 kN
- Minimum operating pressure 692 bar
- Dimensions: 338 × 344 × 83 mm
- Weight (with battery): 6,5 kg
- Operating temperature: -15 to +50 °C

Rechargeable battery

- Type: CB1852L (Li-Ion) 18V, 5 Ah, 93.6 Wh
- Weight: 0,66 kg

Battery charger

- Input: 220-240 V / 50-60 Hz (EU, UK, AU)
- Input: 115 V / 60 Hz (US)

The tool is supplied in a case without the crimping dies.



part No.	Cembre part No.	pressing width mm	punching identification	contacts	wire cross-section	
					mm ²	AWG
C13D 16 C	MK8-C	10	MK 8	C30FA 16, C30MA 16, C30MA 16 P	16	6
C13D 25 C	MK10-C	10	MK 10	C30FA 25, C30MA 25, C30MA 25 P	25	4
C13D 35 C	MK12-C	10	MK 12	C30FA 35, C30MA 35, C30MA 35 P	35	2
C13D 50 C	MK14-C	13	MK 14	C30FA 50, C30MA 50, C30MA 50 P	50	1
C13D 70 C	MK16-C	13	MK 16	C30FA 70, C30MA 70, C30MA 70 P	70	2/0
C13D 95 C	MK18-C	14	MK 18	C30FA 95, C30MA 95, C30MA 95 P	95	3/0
C13D 120 C	MK20-C	14	MK 20	C30FA 120, C30MA 120, C30MA 120 P	120	4/0

MIXO PNEUMATIC METAL CX 02 MPB

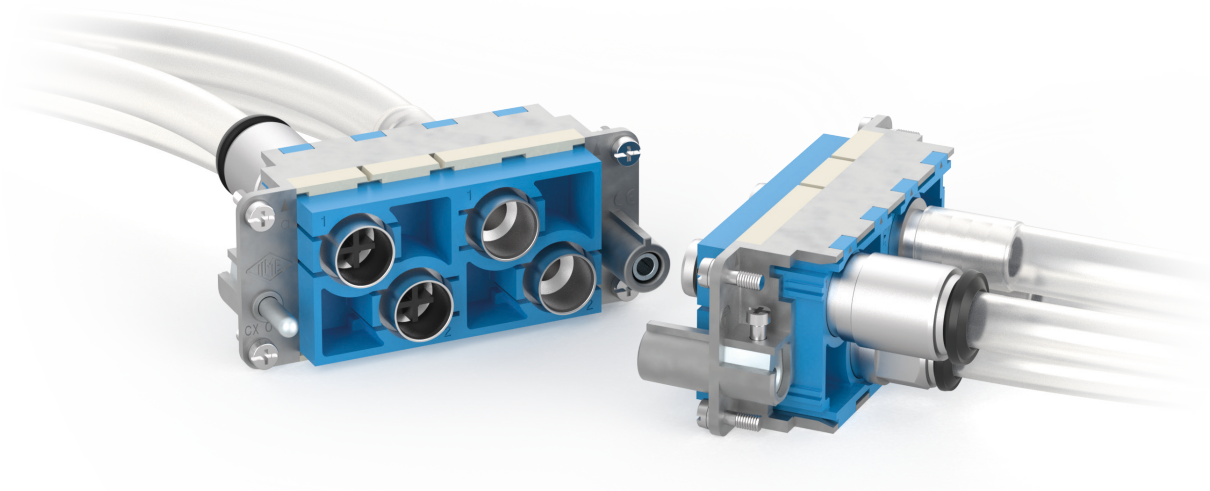

New double-sized connector modules and relevant metal removable pneumatic contacts:

- for transmission of clean and compressed air
- female contacts with or without shut-off valve
- straight version with:
 - hose barbs push-over tube attachment (ID: 8 and 10 mm)
 - quick-fitting push-in tube attachment (OD: 8 and 10 mm)



Find out more
www.ilme.com

TECHNICAL FEATURES

- Q Connector modules (male and female, due to asymmetric design) **for up to 2 metal removable pneumatic contacts** of any of the two **8.0** and **10** sizes available.
- Q Metal pneumatic contacts with hose barbs, push-over tube attachment, straight version (work on ID – inner diameter) for use with hoods with vertical cable outlet, or bulkhead mounting housings.
- Q Metal pneumatic contacts with quick-fitting, push-in tube attachment, straight version (work on OD – outer diameter) for use with hoods with vertical cable outlet, or bulkhead mounting housings.
- Q All **contacts are removable**, without damaging the module or the contact, by means of the **CMPEB B** dedicated removal tool.

- Q For tubes Ø 8 mm and Ø 10 mm (see Table 1. below): outer diameter OD (push-in attachment of tubes to the quick-fitting contacts), or inner diameter ID (push-over attachment of tubes over barbed straight contacts).

✓ CERTIFICATIONS

- cURus, CQC, DNV, BV, pending.
- **CE** and **UKCA** markings and EAC mark not applicable.
- **RoHS:**
 - pneumatic metal module: compliant without exemptions;
 - metal pneumatic contacts: compliant with exemption **6(c)**.

	Tube Ø 8 mm				Tube Ø 10 mm			
	hose barbs (ID - inner Ø)		quick-fitting (OD - outer Ø)		hose barbs (ID - inner Ø)		quick-fitting (OD - outer Ø)	
	Male	Female	Male	Female	Male	Female	Male	Female
Straight <u>without</u> shut-off valve	CX 8.0 MPM	CX 8.0 MPF	CX 8.0 MPQM	CX 8.0 MPQF	CX 10 MPM	CX 10 MPF	CX 10 MPQM	CX 10 MPQF
Straight <u>with</u> shut-off valve		CX 8.0 MPV		CX 8.0 MPQV		CX 10 MPV		CX 10 MPQV

Table 1. Pneumatic contacts

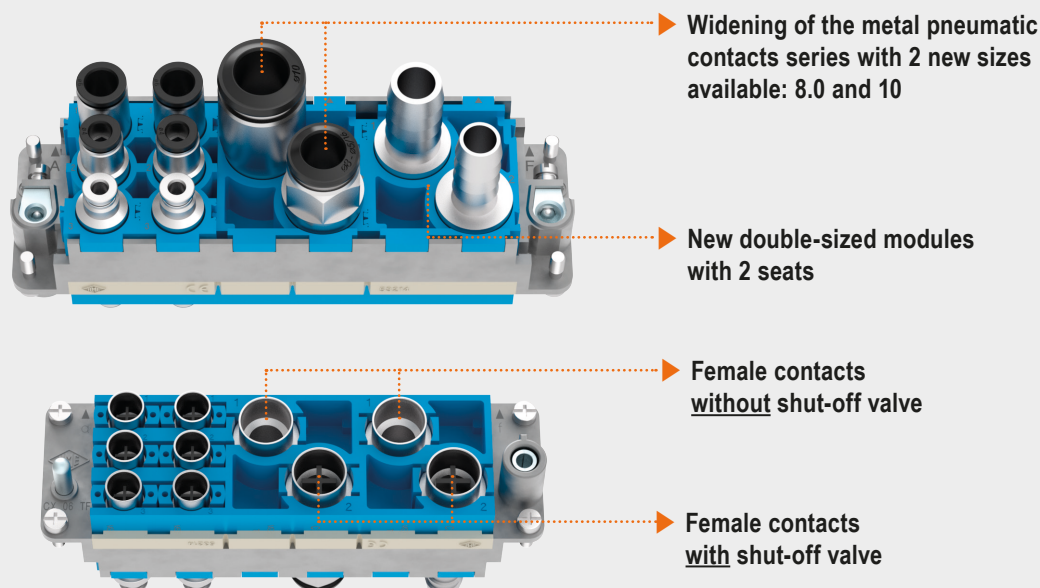

CX 02 MPB metal removable pneumatic contacts

The modular inserts must be installed in suitable frames, which are then mounted in traditional enclosures* or in COB panel supports

page:

frames for modular units*

317

modular units with 2 seats

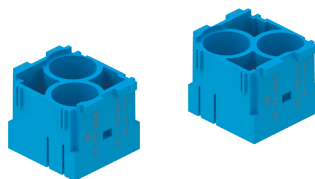

Q 10 000 MATINGS WITH HNM FRAMES AND HNM ENCLOSURES

FROM JUNE 2023

removal tool



FROM JUNE 2023

refer to CN.19 pages

description

part No.

part No.

without contacts (to be ordered separately)
 female insert with 2 housings, for tube \varnothing 8 - 10 mm
 male insert with 2 housings, for tube \varnothing 8 - 10 mm

[CX 02 MPBF](#)
[CX 02 MPBM](#)

removal tool
 for metal pneumatic contacts \varnothing 8 - 10 mm

[CMPES B](#)

- UL, (ECBT2/8), DNV, BV pending
- insulation resistance: $\geq 10 \text{ G}\Omega$
- working temperature range: $-40 \text{ }^\circ\text{C} + 80 \text{ }^\circ\text{C}$
- made of self-extinguishing thermoplastic resin UL 94V-0
- mechanical life:
 ≥ 500 cycles with MIXO frames and enclosures
 ≥ 10.000 cycles with HNM MIXO frames and enclosures

Use of units for metal pneumatic contacts

- pneumatic contacts for pressure values up to 10 bar, for use with clean and dry compressed air
- use of tubes with \varnothing 8 - 10 mm (ID inner \varnothing for hose barbs contacts, OD outer \varnothing for quick-fitting contacts), and possible replacement of tubes with assembled units
- possibility of using tubes with different diameters in the same modular unit
- female contacts with or without closing valve

Warnings:

- CRM/F CX coding and guiding pins must be used for pneumatic contacts modules.
- These pins also provide coding if pneumatic contacts modules are used exclusively.
- The use of pneumatic contacts requires an appropriate filtering and dehydration system to prevent dangerous condensation.

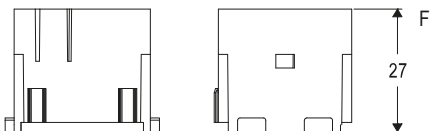
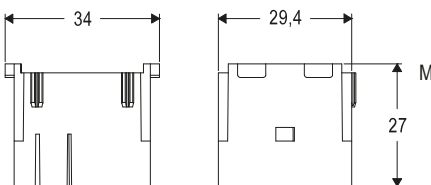

contacts side (front view)
 side with reference arrow ▲

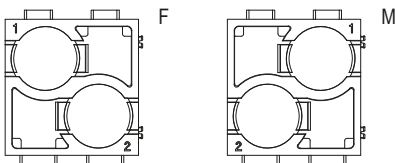

CX 02 MPB metal removable pneumatic contacts

metal pneumatic contacts, straight hose barbs, tube ID inner \varnothing 8 - 10 mm



FROM JUNE 2023

metal pneumatic contacts, straight quick-fitting, tube OD outer \varnothing 8 - 10 mm



FROM JUNE 2023

description	part No.	part No.
hose barbs (ID outer \varnothing) male contacts without shut-off valve without shut-off valve	CX 8.0 MPM CX 10 MPM	
hose barbs (ID outer \varnothing) female contacts without shut-off valve without shut-off valve	CX 8.0 MPF CX 10 MPF	
hose barbs (ID outer \varnothing) female contacts with shut-off valve with shut-off valve	CX 8.0 MPV CX 10 MPV	
quick-fitting (OD outer \varnothing) male contacts without shut-off valve without shut-off valve		CX 8.0 MPQM CX 10 MPQM
quick-fitting (OD outer \varnothing) female contacts without shut-off valve without shut-off valve		CX 8.0 MPQF CX 10 MPQF
quick-fitting (OD outer \varnothing) female contacts with shut-off valve with shut-off valve		CX 8.0 MPQV CX 10 MPQV

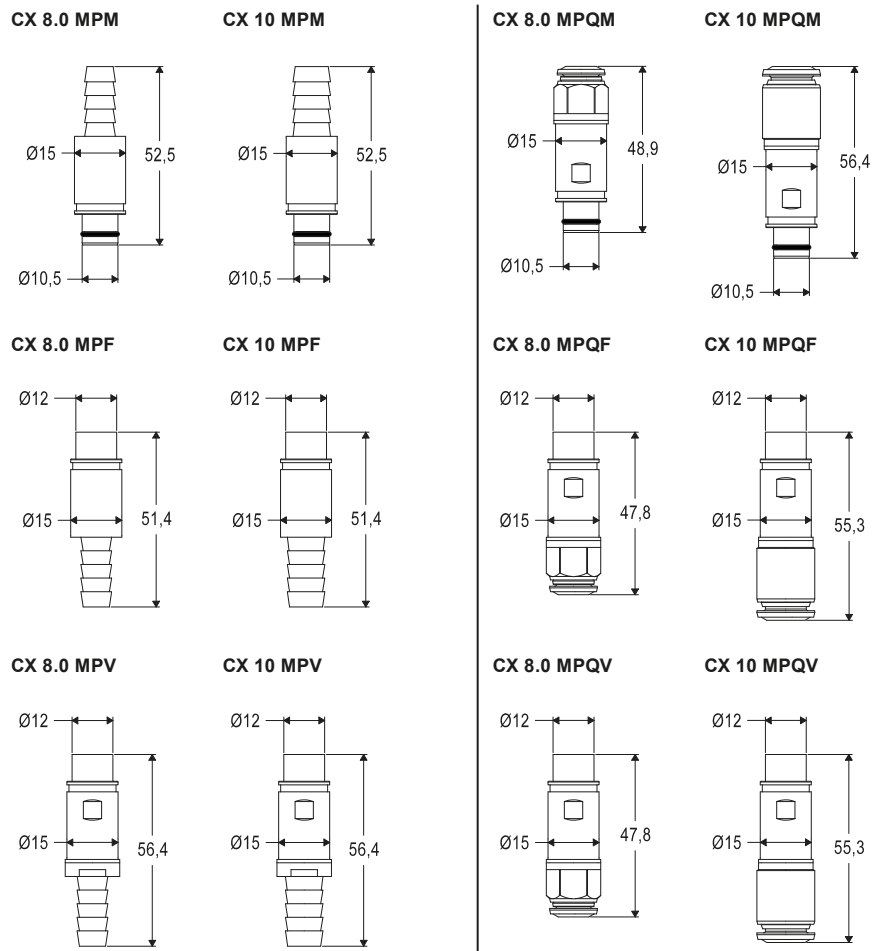

CRIMP CQF /M 04/2E

New inserts in crimp technology

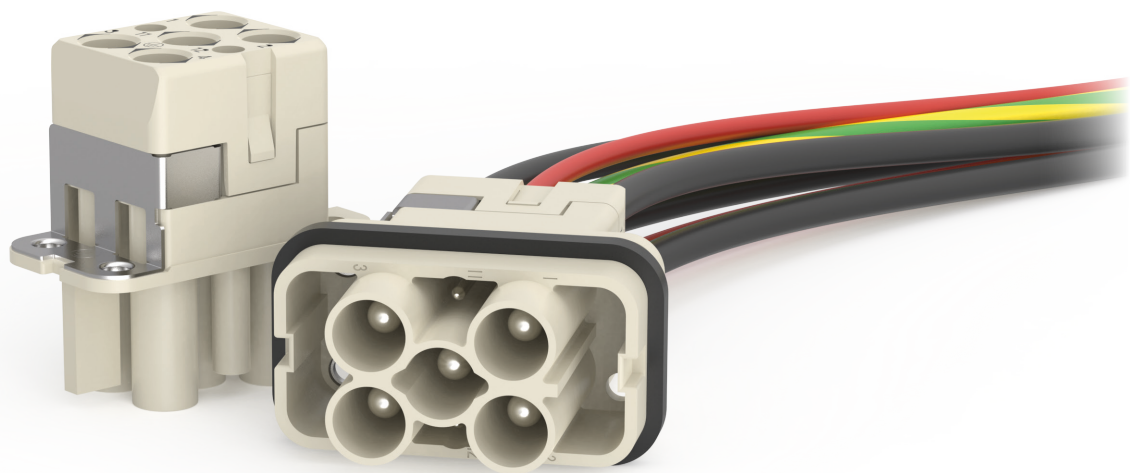

The variant with integral PE plate
of popular CQF /M 04/2 crimp connector inserts

CQ..E connectors with PE plate

4 P + ⊕ (power): 40 A 400/690 V 6 kV 3

2 P (auxiliary): 10 A 250 V 4 kV 3



Find out more
www.ilme.com

TECHNICAL FEATURES

The new **CQF /M 04/2E** size “32.13” crimp connector inserts, for use with series **CX 40 A** power contacts (5 contacts per inserts required) and series **CD** auxiliary contacts, **are the variant with integral PE plate** of popular **CQF /M 04/2** crimp connector inserts, ISO 23570-3 standard and DESINA® specification compliant, with which they are intermateable, for use in the **new size “32.13” metallic enclosures with stainless steel lever series CQA/MQA**.

The integral PE plate implements the equipotential bonding contact between the protective power earth crimp contact (positioned in the middle of the inserts) and the CQA/MQA metal enclosure.

The existing crimp equivalent inserts **CQF /M 04/2** – unsuitable for metallic hoods/housings – needed to be complemented by this new variant, equipped with such integrated PE plate.

These **new crimp version CQF /M 04/2E** (the E after the polarity means with integrated PE plate) is suitable for use either inside traditional size “32.13” CQ/MQ insulating enclosures (where CQF /M 04/2 are enough) or inside the **new size “32.13” series CQA/MQA metallic enclosures (Figure 1)**.

These new connector inserts combined with CQA/MQA metallic enclosures, when used in conjunction with commercially available M25 EMC cable gland, and by replacing the standard rubber sealing gasket provided with the male insert **CQM 04/2E** with the special conductive sealing gasket **CR 08 EMC** (see CN.19 page 575), can provide improved EMC shielding attenuation compared with metallized insulating enclosures **CQS/MQS 08**, necessary when these connectors are used e.g., to feed three-phase AC motors through pulse width modulation (PWM) drives (inverters), for speed/torque motion control, known to inherently produce significant harmonic pollution.

In order to dumb-proof avoid possibly hazardous mounting of any previously available connector inserts not provided with such PE plate (i.e.: CQF /M 08, CQF /M 04/2, CQF /M 17) into the **new series CQA/MQA metallic enclosures**, these have been **provided with a coding** by means of **internal keys** that match only with the corresponding **keyways** foreseen on the new inserts with PE plate bonding connection to the PE contact. These **CQF /M 04/2E** (crimp) connector inserts size “32.13” are added to the already available **CQF /M 08E** (crimp) and **CQYF /M 08E (AXYR®)** as suitable for these metallic “32.13” coded enclosures.

Max diameter of wire sheathings:

- ø 5 mm for 4+PE power poles (max wire size 6 mm² / AWG 10)
- ø 3,8 mm for 2 auxiliary poles (max wire size 2,5 mm² / AWG 14)

✓ CERTIFICATIONS

- cURus, CQC, DNV, BV, EAC pending.
- **CE** and **UK CA** markings.
- RoHS: compliant.

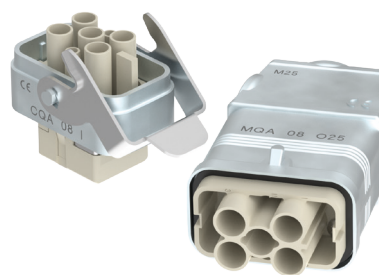
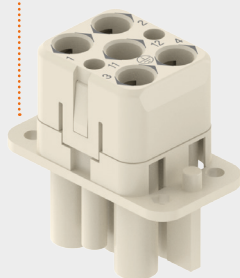
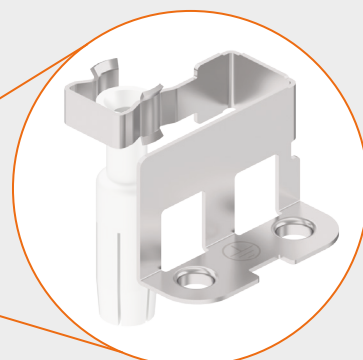
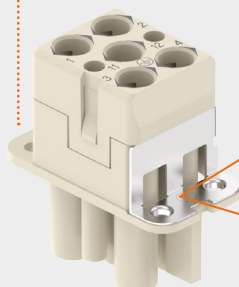

Figure 1.
New size “32.13” series CQA/MQA metallic enclosures

▶ Existing CQF 04/2 crimp connector



▶ New CQF 04/2E with integrated PE plate for bonding to PE of metallic enclosures



▶ PE plate

CQ 04/2E 4 poles + ⊕ (40 A – 400/690 V) + 2 poles (10 A – 250 V)

enclosures:
size "32.13"

page:

insulating type
EMC (insulating)

365 - 367
573 - 574

page:

metallic

38

ISO 23570-3
standard and DESINA.
specification compliant



inserts,
crimp connections

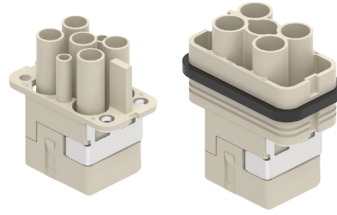

Q SIZE "32.13"

FROM MARCH 2023

refer to CN.19 pages

refer to News 2022 pages

description

part No.

without contacts (to be ordered separately)
female insert with female contacts
male insert with male contacts

[CQF 04/2E](#)
[CQM 04/2E](#)

- characteristics according to EN 61984:
4 poles 40 A 400/690 V 6 kV 3
2 poles 10 A 250 V 4 kV 3

- cURus (ECBT2/8 and PVVA2/8) pending
- CQC, DNV, BV, EAC pending

- rated voltage according to UL/CSA: 600 V
- insulation resistance: $\geq 10 \text{ G}\Omega$
- ambient temperature limit: $-40 \text{ }^\circ\text{C} \dots +125 \text{ }^\circ\text{C}$
- made of self-extinguishing thermoplastic resin UL 94V-0

- mechanical life: ≥ 500 cycles
- contact resistance: $\leq 0,3 \text{ m}\Omega$ (4 P), $\leq 3 \text{ m}\Omega$ (2 P)
- Max diameter of wire sheathings:
- $\varnothing 5 \text{ mm}$ for 4+PE power poles (max wire size 6 mm^2 / AWG 10)
- $\varnothing 3,8 \text{ mm}$ for 2 auxiliary poles (max wire size $2,5 \text{ mm}^2$ / AWG 14)

- for max. current load see the connector inserts derating diagram below; for more information see page 28 of CN.19 catalogue.

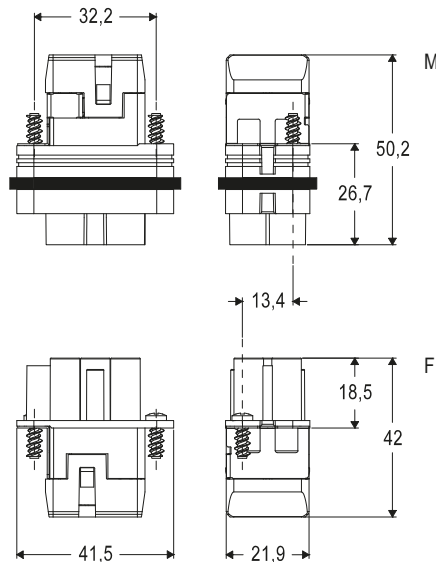

contacts side (front view)

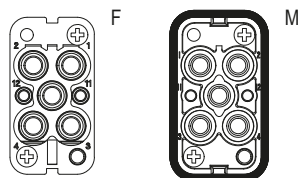

CQ 04/2E, 04/2 power poles connector inserts
Maximum current load derating diagram

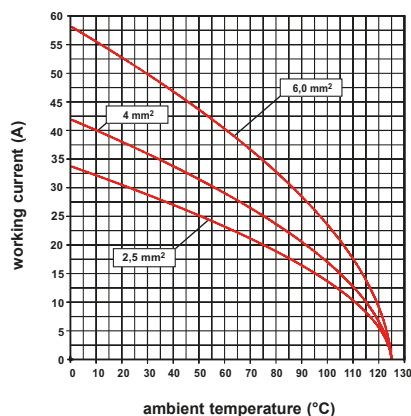

- each insert supplied with 2 fixing screws,
self-tapping, zinc plated steel $\varnothing 2,9 \times 9,5 \text{ mm}$, Ph1

40 A and 10 A crimp contacts silver and gold plated



description		part No.	part No.			
40 A female crimp contacts		silver plated				
1,5 mm ²	AWG 16			CXFA 1.5		
2,5 mm ²	AWG 14			CXFA 2.5		
4 mm ²	AWG 12			CXFA 4.0		
6 mm ²	AWG 10	CXFA 6.0				
40 A male crimp contacts		silver plated				
1,5 mm ²	AWG 16			CXMA 1.5		
2,5 mm ²	AWG 14			CXMA 2.5		
4 mm ²	AWG 12			CXMA 4.0		
6 mm ²	AWG 10	CXMA 6.0				
10 A female crimp contacts		gold plated				
0,14-0,37 mm ²	AWG 26-22			identification No. 1	CDFA 0.3	CDFD 0.3
0,5 mm ²	AWG 20			identification No. 2	CDFA 0.5	CDFD 0.5
0,75 mm ²	AWG 18			identification No. ②	CDFA 0.7	CDFD 0.7
1 mm ²	AWG 18			identification No. 3	CDFA 1.0	CDFD 1.0
1,5 mm ²	AWG 16			identification No. 4	CDFA 1.5	CDFD 1.5
2,5 mm ²	AWG 14	identification No. 5	CDFA 2.5	CDFD 2.5		
10 A male crimp contacts		gold plated				
0,14-0,37 mm ²	AWG 26-22			identification No. 1	CDMA 0.3	CDMD 0.3
0,5 mm ²	AWG 20			identification No. 2	CDMA 0.5	CDMD 0.5
0,75 mm ²	AWG 18			identification No. ②	CDMA 0.7	CDMD 0.7
1 mm ²	AWG 18			identification No. 3	CDMA 1.0	CDMD 1.0
1,5 mm ²	AWG 16			identification No. 4	CDMA 1.5	CDMD 1.5
2,5 mm ²	AWG 14	identification No. 5	CDMA 2.5	CDMD 2.5		

* for basic or high thickness gold plating, please refer to CN.19 at page 674

- it is recommended to crimp the contacts with crimping tools homologated by ILME (please see the crimping tool section 40A contacts, CXF, CXM series and 10A contacts CDF, CDM series on CN.19 at pages 708 - 741)

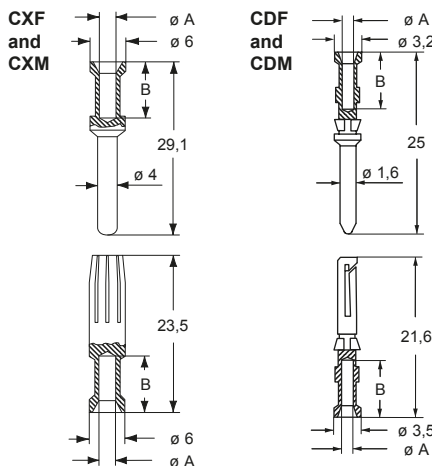

CXF and CDM contacts		
conductor section mm ²	conductor slot ø A (mm)	conductors stripping length B (mm)
1,5	1,8	9
2,5	2,2	9
4	2,85	9,6
6	3,5	9,6
CDF and CDM contacts		
0,14-0,37	0,9	8
0,5	1,1	8
0,75	1,3	8
1,0	1,45	8
1,5	1,8	8
2,5	2,2	6

SD SERIES 10 A STAMPED CRIMP CONTACTS

SDFA.. – SDMA..

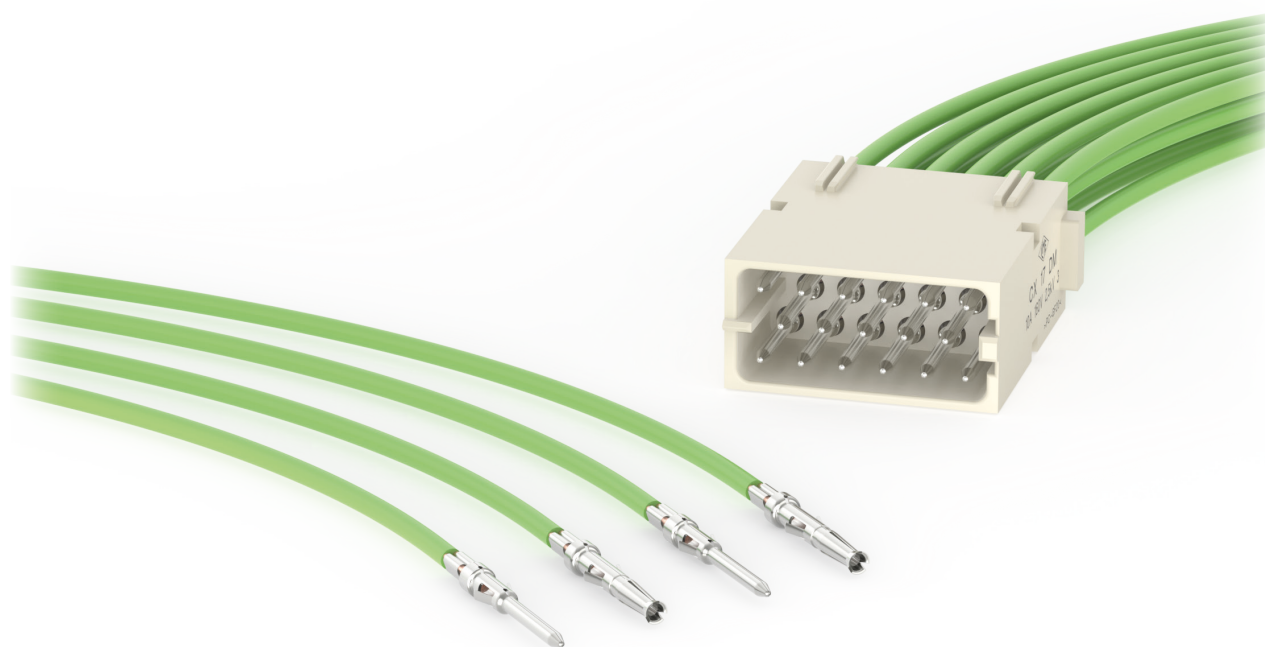

Stamped, open crimp barrel contacts
for stranded copper wires with conductor
cross-sectional area:

- 1.0: 0,37 mm² – 1 mm² (24-18 AWG)
- 2.5: 1,5 mm² – 2,5 mm² (16-14 AWG)



Find out more
www.ilme.com

TECHNICAL FEATURES

Alternative (but not equivalent) to the turned crimp contacts series **CD**, for less demanding applications e.g., reduced current-carrying capacity.

Available with **silver plating** in one performance level for up to **500** mating cycles, either as loose part contacts or in 5 000-piece reels with.

Open crimp barrel contacts without insulation grip, providing tensile strength (pullout force) compliant with EN/IEC 60352 Ed. 2, lower than corresponding turned, closed crimp barrel contacts series CD (EN/IEC 60352-2 Ed.1.0 had two different curves A and B, later consolidated in the lower demanding curve B, whereas ILME CD turned contacts still claim conformity to curve A).

Q Compatible with connector inserts:

- series **CD**;
- series **CDD**;
- series **CQ** and **CQ4**:
CQF /M 07, CQF /M 12 (not the version CIF for interface to PCB), CQF /M 17, CQF /M 04/2, CQ4 03/2 (where underlined, auxiliary poles only);
- combined connector inserts series **CX**:
CXF /M 8/24, CXF /M 6/12, CXF /M 6/36, CXF /M 12/2, CX 1/2 BDF /M;
- series **MIXO** modules:
CX 12 DF /M, CX 17 DF /M, CX 42 DF /M, CX 3/4 XD, CX 01 BF /M (MIXO COAX), CX 04 BF /M (MIXO BUS 4P), CX 01 JF /M, CX 02 JF /M.

Q Derating diagrams of previous inserts / modules are under construction: expected to show ca. 10% less current-carrying capacity than when inserts employ corresponding turned contacts series CD.

Q Available in **2 sizes**:

- **1.0** for stranded copper wires with conductor cross-sectional area 0,37 mm²- 1 mm² (24-18 AWG);
- **2.5** for stranded copper wires with conductor cross-sectional area 1,5 mm²- 2,5 mm² (16-14 AWG).

Q Crimping tools: see page 67.

Q Removal tool: same as for series CD machined crimp contacts.

✓ CERTIFICATIONS

- cURus, CQC, DNV, BV, EAC pending.
- **CE** and **UK** markings.
- **RoHS**: compliant.

Widening of the ILME portfolio ►
of stamped crimp contacts with
the new **SD Series (10 A)**

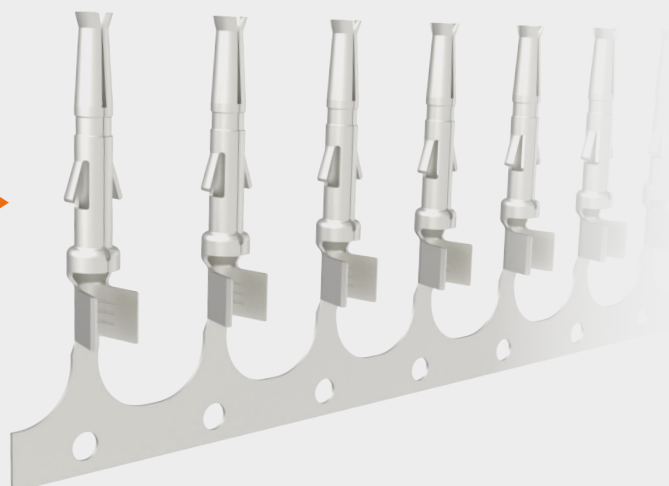

SDFA – SDMA 10 A stamped contacts

inserts:		page:	
CD	(10 A)	66 - 74	
CDD	(10 A)	76 - 83	
CQ	(10 A)	187 - 193	
CX 8/24	(16 A/10 A)	194	
CX 6/12 *	(10 A)	197	
CX 6/36 *	(10 A)	198	
CX 12/2 *	(40 A/10 A)	199	
RD (HNM)	(10 A)	208 - 209	
RDD (HNM)	(10 A)	210 - 213	
MIXO	(10 A/16 A)	271 - 306	
		page:	
CQ4 03/2 *		16	
CX 9/42 *		20	
CX 08 D5/D5..2		44	
CX 08 D5G/D5G..2		52	
CQ 04/2E *		62	

* the underlined polarities indicate those contacts that require the tools shown in this page

refer to CN.19 pages refer to News 2021 pages
refer to News 2020 pages

SD 10 A crimp contacts



Q STAMPED CONTACTS FROM OCTOBER 2023

SD 10 A crimp contacts

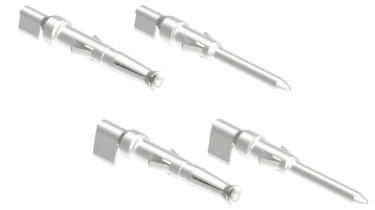

Q STAMPED CONTACTS FROM OCTOBER 2023

description	part No.	pcs. (1 packaging unit)	part No.	pcs. (1 packaging unit)
female stamped crimp contacts (loose parts)		200		
0,37 mm ² - 1 mm ² AWG 24-18	SDFA 1.0			
1,5 mm ² - 2,5 mm ² AWG 16-14	SDFA 2.5			
male stamped crimp contacts (loose parts)		200		
0,37 mm ² - 1 mm ² AWG 24-18	SDMA 1.0			
1,5 mm ² - 2,5 mm ² AWG 16-14	SDMA 2.5			
female stamped crimp contacts (reel package)				5000
0,37 mm ² - 1 mm ² AWG 24-18	SDFA 1.0R			
1,5 mm ² - 2,5 mm ² AWG 16-14	SDFA 2.5R			
male stamped crimp contacts (reel package)				5000
0,37 mm ² - 1 mm ² AWG 24-18	SDMA 1.0R			
1,5 mm ² - 2,5 mm ² AWG 16-14	SDMA 2.5R			

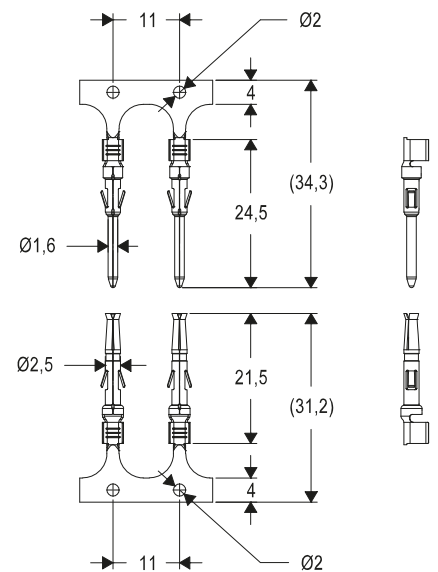
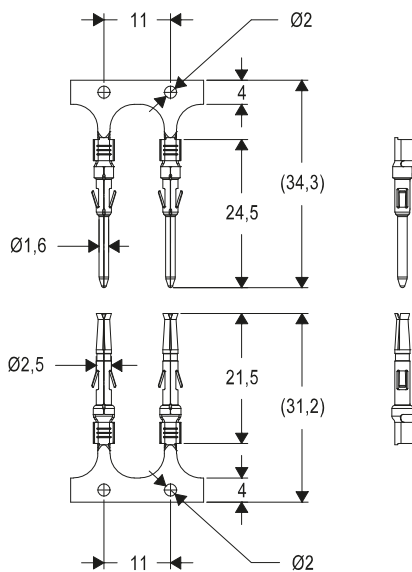

Recommended crimping tools
Loose parts: **SDPZ TP**
Reel package: suitable for stripping / crimping automated machines to be used with 5 000 pieces reels, please contact ILME S.p.A.

SDFA.. R – SDMA.. R

Reel unrolling left

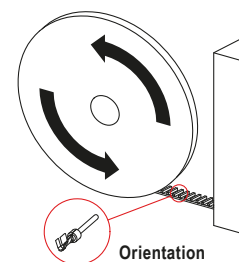

Tools and accessories for crimp contacts

for contacts of inserts series

CD	(10 A)	66 - 74
CDD	(10 A)	76 - 83
CQ	(10 A)	187 - 193
CX 8/24	(16 A/10 A)	194
CX 6/12 *	(10 A)	197
CX 6/36 *	(10 A)	198
CX 12/2 *	(40 A/10 A)	199
RD (HNM)	(10 A)	208 - 209
RDD (HNM)	(10 A)	210 - 213
MIXO	(10 A/16 A)	271 - 306

page: crimping tool



insertion tool - removal tool replacement tip



CQ4 03/2 *		16
CX 9/42 *		20
CX 08 D5/D5..2		44
CX 08 D5G/D5G..2		52
CQ 04/2E *		62

* the underlined polarities indicate those contacts that require the tools shown in this page

refer to CN.19 pages refer to News 2021 pages
refer to News 2020 pages

description	part No.	part No.	part No.
pneumatic tool for 10 A SD contacts (for loose pcs) RENNSTEIG model PEW12 (crimping dies and turret head are included)	SDPZ TP		
removal tool for the extraction of contacts from the inserts for 10 A contacts		CCES	
replacement tip for CCES removal tool			CCPR RN

SIZE "21.21" METALLIC HOODS WITH M25 ANGLED CABLE ENTRY

MKA..VA25



The new M25 angled cable entry metallic hood widens the offer with four different variants: standard, DESINA®, W-TYPE and EMC



Find out more
www.ilme.com

TECHNICAL FEATURES

This new metallic (zinc alloy) hood with M25 angled cable entry widens the offer of "21.21" metallic hoods already available (MKA V20, MKA V25 and MKA VG25) and is provided in four different variants:

- Q **standard**, with epoxy-polyester powder coating, colour RAL 7040;
- Q **DESINA®**, same as the standard but with glued sealing gasket, for inserts such as the hybrid socked and plug connectors for field buses prescribed by the DESINA® specifications and ISO 23570-2 standard;
- Q **W-TYPE**, with epoxy powder coating, colour black, with improved corrosion resistance for aggressive environments;
- Q **EMC, S-TYPE**, with conductive surface, for improved shielding, in combination with EMC cable gland.

Suitable for the wiring with cables with large diameter (large wire size) e.g. in combination with series **CQ4** 40 A inserts, or series CQ with large number of individual conductors. e.g. in combination with **CQ 21** inserts.

Full compatibility with all range of existing "21.21" hoods with locking lever and housings.

✓ CERTIFICATIONS

- cURus (Type 12, 4, 4X), CQC, DNV, BV pending.
- **CE** and **UKA** markings. EAC not applicable.
- **RoHS**: compliant.

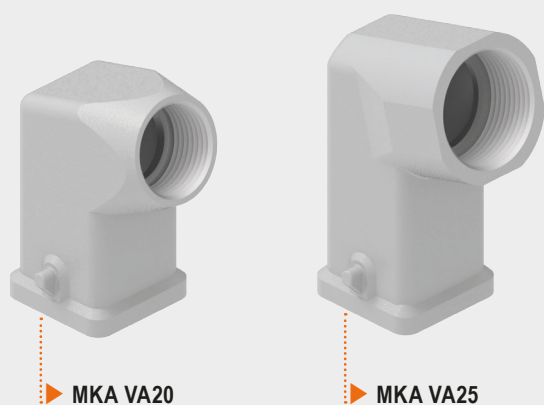

▶ MKA VA20

▶ MKA VA25

▶ Comparison between the MKA VA20 hood and the **new, higher MKA VA25** one

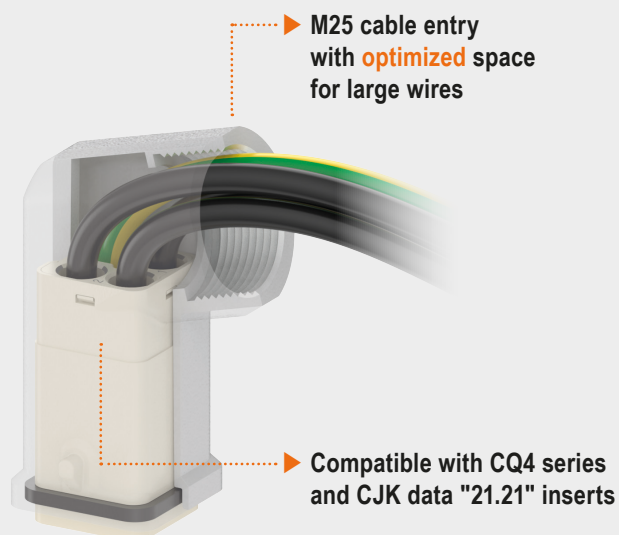

▶ M25 cable entry with **optimized** space for large wires

▶ Compatible with CQ4 series and CJK data "21.21" inserts

MKA – MKAG standard metallic version

inserts:		page:
CK	3 and 4 poles + ⊕	58
CKS	3 and 4 poles + ⊕	-
CKSH	3 and 4 poles + ⊕	63
CD	8 poles + ⊕	67
CQ4	2 poles + ⊕	182
CQ4 H	2 poles + ⊕	183
CQ4	3 poles + ⊕	184
CQ4	3 poles + ⊕ + 2 poles	16
CQ	5 poles + ⊕	186
CQ	7 poles + ⊕	187
CQ	12 poles + ⊕	189
CQ	21 poles	190

for DESINA® hood:	
CJ KM	223
CJK 8MT	226
CJK 8M	233
CX 1/2 BD	243
CXL 2/4 PF/PM	251
CXL 2/4 PFH/PMH	251
CXL PF/PM	251

refer to CN.19 pages refer to News 2020 pages

hood

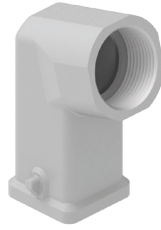

FROM FEBRUARY 2023

hood with glued gasket, DESINA®▲



FROM FEBRUARY 2023

description	part No. (entry M25)	part No. (entry M25)
-------------	-------------------------	-------------------------

with pegs, side entry	MKA VA25	
-----------------------	--------------------------	--

with pegs and glued gasket, side entry		MKAG VA25
--	--	---------------------------

gasket and screw kit for IP66/IP67/IP69 ¹⁾	CKR 65	
---	------------------------	--

gasket and screw kit for IP66/IP67/IP69 ¹⁾ specific for CD 08 inserts	CKR 65 D	
---	--------------------------	--

¹⁾ To obtain the IP66/IP67/IP69 degree of protection it is necessary to replace the fixing screw supplied with all inserts, with the one with gasket included in the kit (to be purchased separately) **except for** the inserts CQF/M 07 and CQF/M 12 (already supplied with a fixing screw with gasket)

▲ Suitable for **DESINA®** CXL inserts and C.J., CUK, CX BD adapters for male inserts without gasket

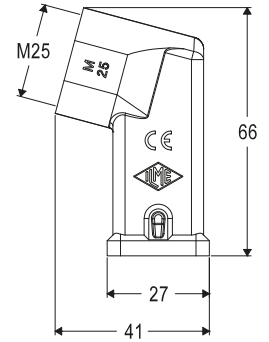
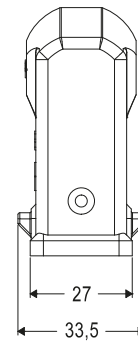
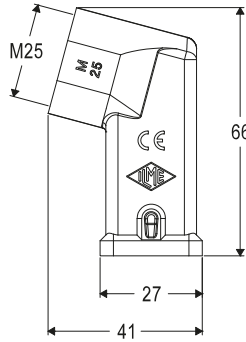
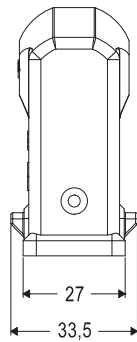

cURus
Type 4/4X/12 pending

for **MKA VA25**
IP66/IP67/IP69 with CKR 65 (D)¹⁾

for **MKAG VA25**
DESINA® hood

MKAW – MKAS W-TYPE and EMC S-TYPE

inserts:

CK	3 poles + ⊕	58
CK	4 poles + ⊕	58
CKS	3 poles + ⊕	-
CKS	4 poles + ⊕	-
CKSH	3 poles + ⊕	63
CKSH	4 poles + ⊕	63
CD	8 poles + ⊕	67
CQ4	2 poles + ⊕	182
CQ4 H	2 poles + ⊕	183
CQ4	3 poles + ⊕	184
CQ4	3 poles + ⊕ + 2 poles	16
CQ	5 poles + ⊕	186
CQ	7 poles + ⊕	187
CQ	12 poles + ⊕	189
CQ	21 poles	190

page:

hood, W-TYPE



hood, EMC

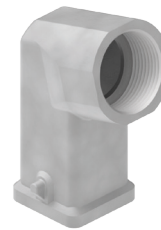

refer to CN.19 pages

refer to News 2020 pages

FROM FEBRUARY 2023

FROM FEBRUARY 2023

description

part No.
(entry M25)

part No.
(entry M25)

with pegs, side entry

[MKAW VA25](#)

with pegs, side entry

[MKAS VA25](#)

gasket and screw kit
for IP66/IP67/IP69¹⁾

[CKR 65](#)

[CKR 65](#)

gasket and screw kit for IP66/IP67/IP69¹⁾
specific for CD 08 inserts

[CKR 65 D](#)

[CKR 65 D](#)

¹⁾ To obtain the IP66/IP67/IP69 degree of protection it is necessary to replace the fixing screw supplied with all inserts, with the one with gasket included in the kit (to be purchased separately) **except for** the inserts CQF/M 07 and CQF/M 12 (already supplied with a fixing screw with gasket)

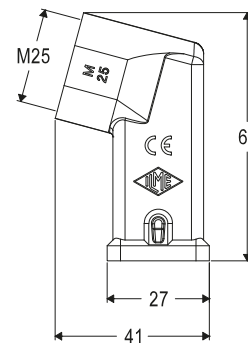
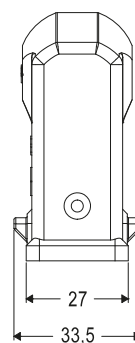
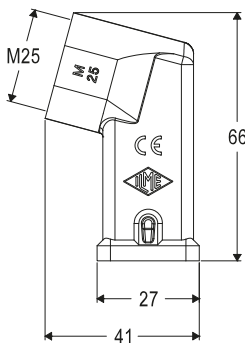
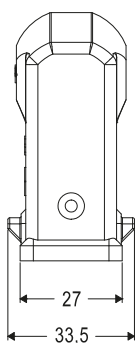

cURus
Type 4/4X/12 pending



IP66/IP67/IP69 with CKR 65 (D)¹⁾

MIXO TWO ENCLOSURES

For 2 single-slot sized MIXO modules

CXA 02.. – MXA 02..



Robust zinc die-cast connector enclosures available as:

- one bulkhead mounting housing;
- M25 or M32, horizontal or vertical, four hood variants



Find out more
www.ilme.com

TECHNICAL FEATURES



Watch our
technical clip

MIXO TWO is the new compact metal housings system designed by ILME to accept two of the wide range of MIXO series single-sized modules. These **robust zinc die-cast connector enclosures** are available as one **bulkhead mounting housing** and four **hood** variants, differing by position and size of the cable entry: **M25** or **M32**, horizontal or vertical. Together, they transform two suitable single-sized MIXO module, that can be chosen to form a myriad of different combinations, into a **completely independent** and compact connector.

Each **MIXO TWO** enclosure comes with a **dedicated two-slot MIXO frame** which incorporates sliding **captive module locking tabs** and, in the middle, a **pre-leading (first-make, last-break) PE contact** with relevant screw terminal, for the safest connector operation.

The housing of two single-sized MIXO modules is allowed in a guided way, avoiding incorrect match with a correspondingly mating connector assembly inside the counterpart MIXO TWO enclosure. The complete connectors using MIXO TWO enclosures result polarized to avoid incorrect 180° reversed mating with corresponding connector.

- Q **zinc** die cast alloy, thermosetting powder coated **bulkhead mounting housing** with **IL-BRID locking lever**, with stainless steel core, releasably mounted on moulded pegs, and flange and interface NBR sealing gaskets, glued on bottom and top contours;
- Q **zinc** die cast alloy, thermosetting powder coated **hoods in one part**, to allow simpler MIXO module mounting thanks to the separate modules holding frame that provides the PE connection;
- Q **zinc** die cast alloy **modules holding frame** with **pre-leading PE contact** (female on the hoods, male on the bulkhead mounting housing) for enclosure's equipotential bonding to earth, two captive **sliding locking tabs** made by insulating thermoplastic material, for fixing the modules to the frame, and two captive **galvanized zinc steel M4 screws** with hexagonal socket cylindrical head, for screwdriver's hexagonal **tip size s = 3 mm**, for fixing the assembly of frame + modules to either the panel or the hood;

- Q PE pre-leading contacts with **M4 screw terminal**, for Ph1 screwdriver or 1 × 5,5 mm flat blade screwdriver, 1,2 Nm / 10,6 lb.in tightening torque, for unprepared wires up to 10 mm² (6 AWG), ferruled wires prepared with any ferrule crimping tool up to 6 mm² (10 AWG), or with **CCXA02PZ W** special ferrule crimping tool for 10 mm² (6 AWG) wire;
- Q **protection covers** for hoods and housings made in shock-proof self-extinguishing thermoplastic material (UL 94V-2) suitable for outdoor exposure, either **with pegs** (for enclosures with locking lever and sealing gasket) or **with locking lever and sealing gasket** (for enclosures with pegs) available either with stainless-steel cord, eyelet-terminated (for fixing to the housing) or loop-terminated (for fixing to the hoods, around the incoming cable).

The new series **MIXO TWO** of metallic enclosures for modular connector inserts is the natural complement of series **MIXO ONE**. Where the last one provided a compact protective solution to transform **one** single-sized MIXO connector module into a complete connector, **MIXO TWO** enclosures do the same with **two** single-sized series MIXO connector modules, giving the chance to obtain a 2-module complete connector in a more compact space than by using size "57.27" standard hood and housing and relevant MIXO frames.

- Q Due to the desired utmost compactness of this enclosures system, spacings between live parts of the hosted connector modules and the inner surface of the hoods and housing is reduced compared to the corresponding size "44.27" enclosures. Modules with rated insulation voltages higher than 690 V (e.g. 830 V or 1000 V) and rated impulse voltage higher than 6 kV (e.g. 8 kV) used in MIXO TWO enclosures **are limited to such rated values: 690 V 6 kV 3** (see page 75).
- NOTE – Some single-sized MIXO modules are not compatible due to additional contour constraints compared with the panel cut-out required for the bulkhead mounting model.

✓ CERTIFICATIONS

- cURus (Type 12, 4, 4X), CQC, DNV, BV, pending.
- **CE** and **UKCA** marking. EAC not applicable.
- **RoHS**: compliant with exemption **6(c)**.

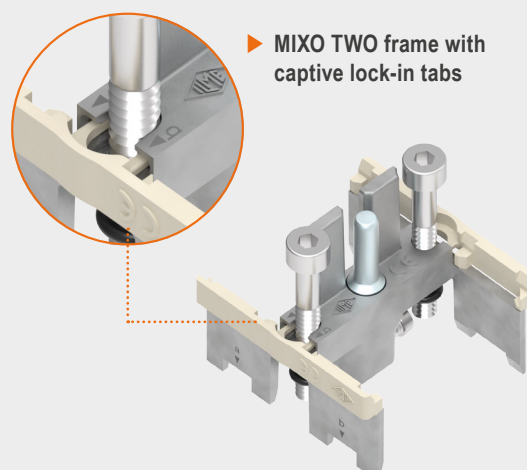
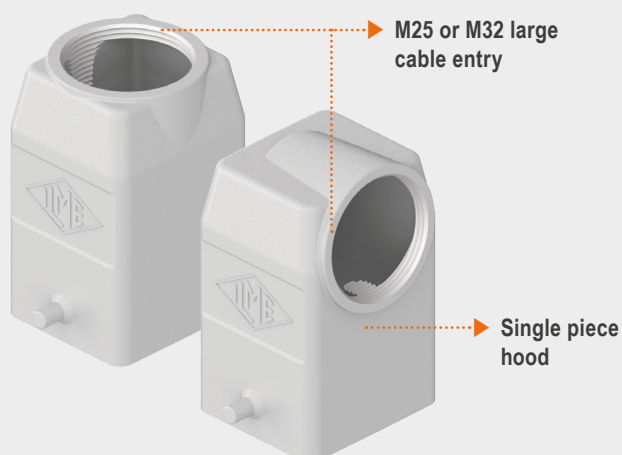

FOCUS ON

PE requirements for connector modules using MIXO TWO enclosures

The PE pin and socket contacts on the **modules holding frames of MIXO TWO enclosures** realize a FMLB (*first-make, last-break*) function with respect to all the line contacts of the housed module/s, although the housed connector modules are COC (*connectors without breaking capacity*) and only CBC (*connectors with breaking capacity*) would strictly require the FMLB function for the PE.

MIXO modules are not equipped by themselves with a PE terminal or a seat for a PE contact, as they are deemed to be assembled and mounted into the dedicated MIXO metallic frames, which are then provided on their short sides with 2 differently-sized PE terminals and the relevant pin-and-socket contacts.

Connectors are usually employed to feed electrical equipment. If rated in **voltage band II** (e.g., 230 V_{AC} or 500 V_{AC}), i.e., above the **ELV voltage band I** (ELV ≤ 50 V_{AC}/120 V_{DC}) and if the equipment is not designed as a class II one (double-insulated), **the electrical equipment requires the PE protective earthing connection**; hence, the feeding connector is in turn required to have a PE connection, serving both as equipotential bonding to earth of exposed metal parts of its enclosure, and as PE (protective earth), for carrying the equipment's fault current and keeping contact continuity until the tripping of the upstream-installed protective device.

In such case the connector must be equipped with a PE contact with a connecting capacity which is (see IEC 61984, subclause 6.5.4.1, Table 1, column 2):

line wire size (mm ²)	PE wire size (mm ²)
S ≤ 16	same as line
16 < S ≤ 35	16

MIXO connector modules, when used within the ELV (extra-low voltage) voltage band I do not require a protective earth contact for the served circuit and equipment; therefore, in such condition, even larger power MIXO modules such as the 70 A module **CX 02 7F /M** or the single-pole 100 A module **CX 01 GF /M** can be employed, both within **MIXO ONE** and **MIXO TWO** enclosures, as there is no need to combine the relevant circuit with a protective earth contact of suitable corresponding wire size. In such case, the PE contact and wiring provided by the MIXO ONE and MIXO TWO enclosures serves merely as equipotential bonding to earth for the exposed metal parts of the enclosure itself. To note that, being metallic, neither MIXO ONE nor MIXO TWO enclosures are deemed to be employed in connectors for class II equipment.

☞ NOTE – The PE terminal of the module holding frame provided with the new MIXO TWO enclosures does not accept any of the PE adapters available for MIXO frames.

☞ For use to feed equipment rated in **voltage band II** (e.g., 230 V_{AC} or 500 V_{AC}), MIXO modules suitable for use are those whose wire size does not exceed that of the PE terminal, i.e., ≤ 10 mm² (6 AWG).

MIXO 70 A module **CX 02 7F /M** and MIXO 100 A single module **CX 01 GF /M** can be used in **MIXO TWO** enclosures **with up to size 10 contacts**. For larger size contacts, they can be used only if the connector is deemed for ELV (voltage band I, where no PE is required for the served circuit).

The correct choice and implementation of the relevant cable assemblies are in the full responsibility of the designer of the system.

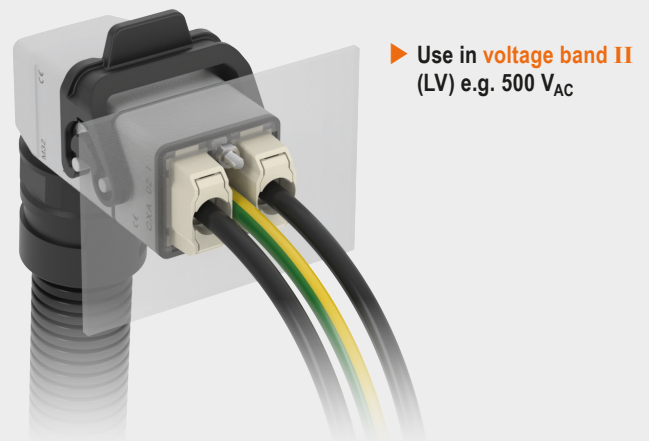
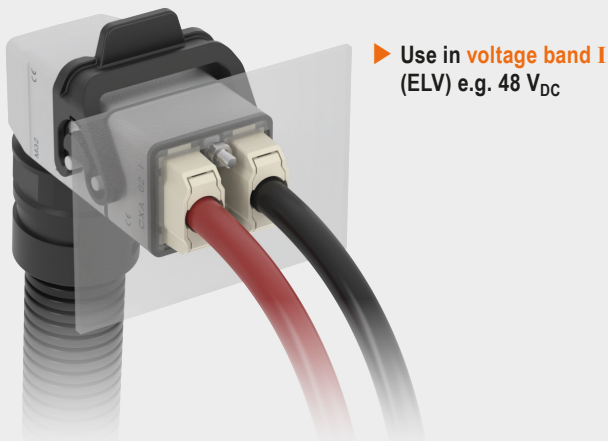

FOCUS ON

Mix of single-sized inserts suitable for use inside MIXO TWO enclosures

Inserts	Contact type	Signal type	Kind of connection	Rated current (A)	Rated voltage (V)	Rated impulse voltage (kV)
⚠ CX 01 GF/M *	main	electric	crimp	100	500	6
⚠ CX 02 7F/M **	main	electric	crimp	70	690	6
⚠ CX 02 4AF/M	main	electric	axial screw	40	690	6
⚠ CX 02 4BF/M	main	electric	axial screw	40	690	6
⚠ CX 02 4F/M	main	electric	crimp	40	690	6
CX 03 4F/M	main	electric	crimp	40	400 / 690	6
CX 03 4BF/BM	main	electric	crimp	40	500	6
⚠ CX 3/4 XDF/M	main / auxiliary	electric	crimp	40 / 10	690	6
⚠ CX 04 XF/M	main	electric	crimp	40	690	6
CX 05 SF/M	main	electric	spring	16	400	6
CX 05 SHF/M	main	electric	SQUICH®-spring	16	400	6
CX 06 CF/M	main	electric	crimp	16	500	6
CX 06P CF/M	main	electric	crimp	16	690	6
CX 06 CYF/M	main	electric	AXYR®-spring	16	500	6
CX 08 CYF/M	main	electric	AXYR®-spring	16	400	6
CX 12 DF/M	main / auxiliary	electric	crimp	10	250	4
+ CX 12 DYF/M	main / auxiliary	electric	AXYR®-spring	10	250	4
CX 17 DF/M	main / auxiliary	electric	crimp	10	160	2,5
CX 01 9VF/M	D-SUB	electric	crimp	5	50	0,8
CX 01 9VTF	D-SUB	electric	screw	5	50	0,8
CX 01 9VF2/M2	D-SUB + shield	electric	crimp	5	50	0,8
CX 08 I6F/M	main + shield	electric	crimp	5	50	0,8
CX 08 I6GF/I6GM	main + shield	electric	crimp	5	50	0,8
CX 25 IBF/M	main / auxiliary	electric	crimp	4	50	0,8
CX 36 IF/M	main / auxiliary	electric	crimp	4	32	0,8
CX 20S IF/M	main / auxiliary + shield	electric	crimp	4	32	0,8
CX 20S IGF/IGM	main / auxiliary + shield	electric	crimp	4	32	0,8
CX 04 RF/M	coaxial	electric	crimp	—	—	0,8
CX 01 J8AIF/BIF/PIF	RJ45 + shield	electric	IDC	1	50	0,8
CX 01 J8F/M/IM	RJ45	electric	crimp / IDC	—	—	0,8
CX 01 J8UM	RJ45	electric	IDC	—	—	0,8
CX 04 LF/M	POF / MOST	optic	crimp	—	—	—
CX 04 SCF/M	SC fibre optic	optic	crimp / glue	—	—	—
CX 03 MP	pneumatic metal Ø 3,0 - 4,0 - 6,0 mm	air	push-in / quick-fitting	—	—	—
CX 03 P	pneumatic plastic Ø 1,6 - 3,0 - 4,0 mm	air	push-in	—	—	—
CX 02 P	pneumatic plastic Ø 6,0 mm	air	push-in	—	—	—
CX FM	none (dummy module)	—	—	—	—	—

⚠ Reduced rated voltage and rated impulse voltage.

+ 2023 new product

* CX 01 GF/M limited to use up to 500 V 6 kV with CGFA /MA 10 contacts. Wiring with CG contacts of larger size is possible only if used in ELV ($\leq 50 V_{AC}/120 V_{DC}$, not requiring PE).

** CX 02 7F/M limited to use up to 690 V 6 kV with CX7FA /MA 6.0 or 10 contacts. Wiring with CX7 contacts of larger sizes is possible only if used in ELV ($\leq 50 V_{AC}/120 V_{DC}$, not requiring PE).

CXA – MXA MIXO TWO enclosures

MIXO inserts:

CX 01 G	1 module	264
CX 02 7	1 module	266
CX 02 4	1 module	267
CX 02 4A/4B	1 module	268
CX 03 4	1 module	269
CX 03 4B	1 module	270
CX 3/4 XD	1 module	271
CX 04 X	1 module	272
CX 05 S	1 module	-
CX 05 SH	1 module	274
CX 06/06P C	1 module	275, 276
CX 08 C	1 module	277
CX 12 D	1 module	281
CX 17 D	1 module	282
CX 25 IB	1 module	284
CX 25 I	1 module	-
CX 08 I6/I6G	1 module	286
CX 01 9V/9VT	1 module	296, 298
CX 04 L/R	1 module	299, 300
CX 04 SC	1 module	301
CX 01 J8/J8I	1 module	302
CX 02/03 P	1 module	312
CX 06 CY	1 module	21, 22
CX 12 DY	1 module	29, 30
CX 36 I	1 module	29, 30
CX 20S I	1 module	35
CX 20S IG	1 module	50

■ refer to CN.19 pages ■ refer to News 2022 pages
■ refer to News 2020 pages ■ refer to News 2023 pages
■ refer to News 2021 pages

page:

bulkhead mounting housings with single lever

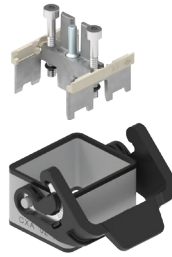

FROM JULY 2023

hoods with 2 pegs

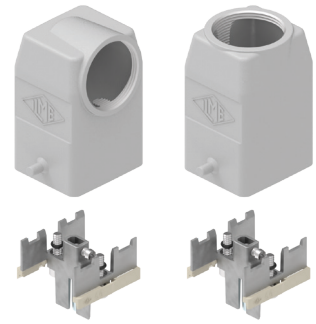

FROM JULY 2023

description	part No.	part No.	entry M
with lever	CXA 02 I		
with pegs, side entry		MXA 02 O25	25
with pegs, side entry		MXA 02 O32	32
with pegs, top entry		MXA 02 V25	25
with pegs, top entry		MXA 02 V32	32

panel cut-out for MIXO TWO - threaded panel

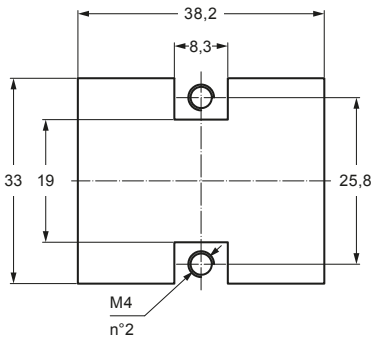

panel cut-out for MIXO TWO - through-holes panel (max. panel thickness: 6 mm)

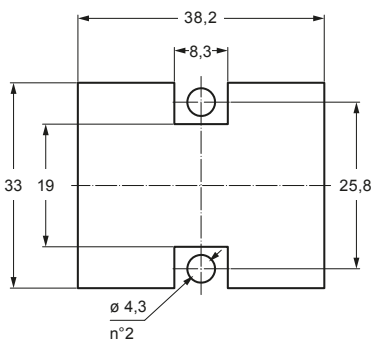

cURus
Type 4/4X/12 pending

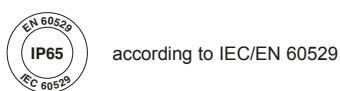

CXA 02 I

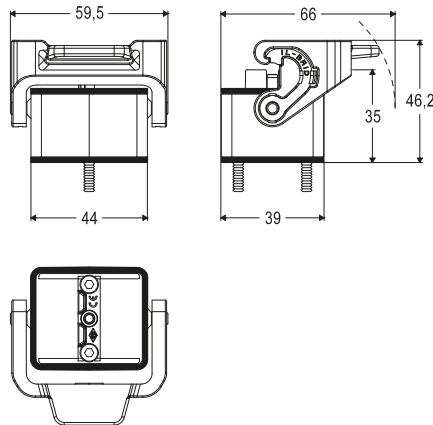

MXA 02 O

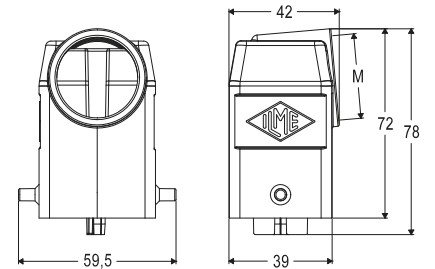

MXA 02 V

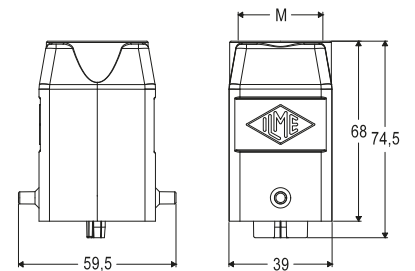

plastic covers



FROM JULY 2023

plastic covers with lever and gasket



FROM JULY 2023

description

part No.
(with eyelet)

part No.
(with loop)

with 2 pegs (for enclosures with 1 lever and gasket)
with 1 lever and gasket (for hoods with 2 pegs)

[CXP 02 C](#)

[CXP 02 CLG](#)

CXP 02 C

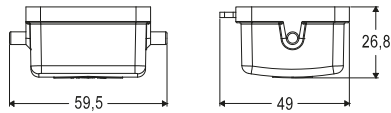

CXP 02 CLG

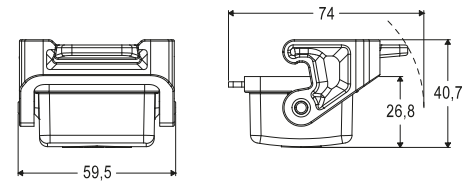

cURus
Type 4/4X/12 pending



according to IEC/EN 60529

For fixing on housings

eyelet

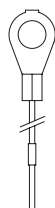

For fixing on hoods

loop

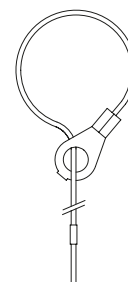

ASSEMBLY INSTRUCTIONS

MIXO TWO - HOOD INSERTS ASSEMBLY

1

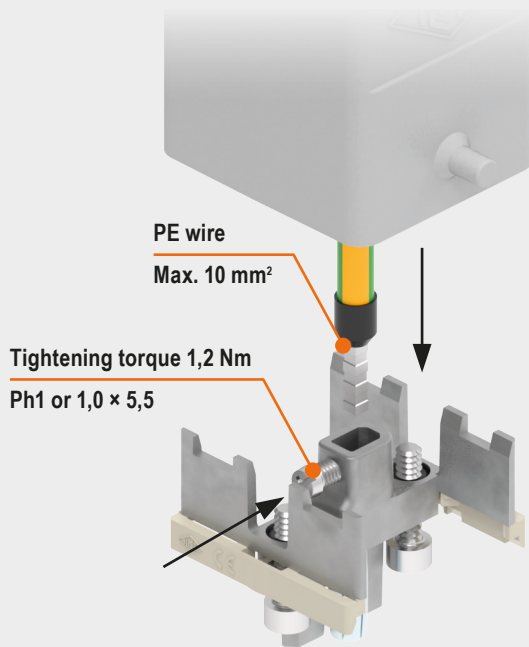

2

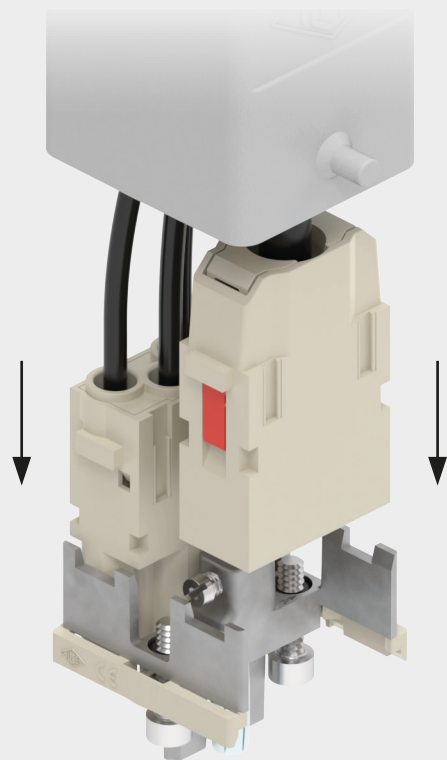

3

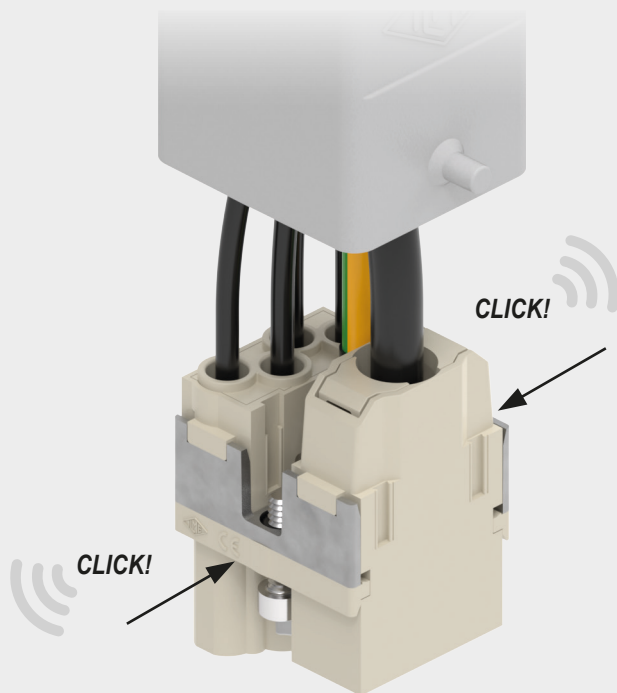

4

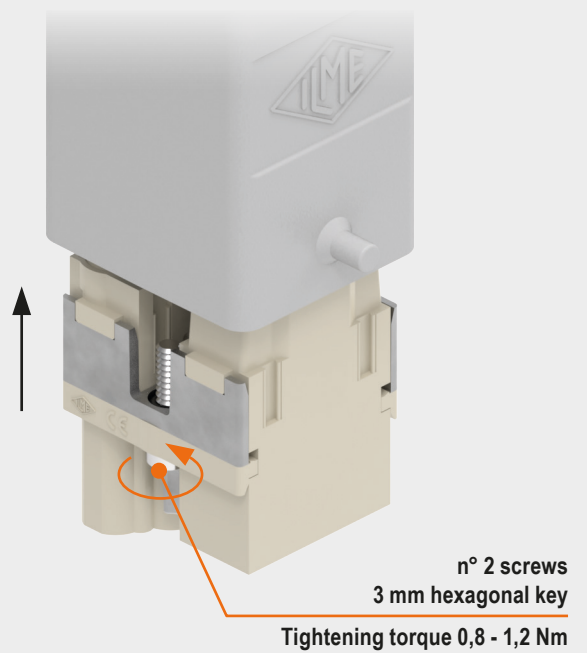

The MIXO modular inserts depicted are only for demonstration purposes

ASSEMBLY INSTRUCTIONS

MIXO TWO - HOUSING INSERTS ASSEMBLY

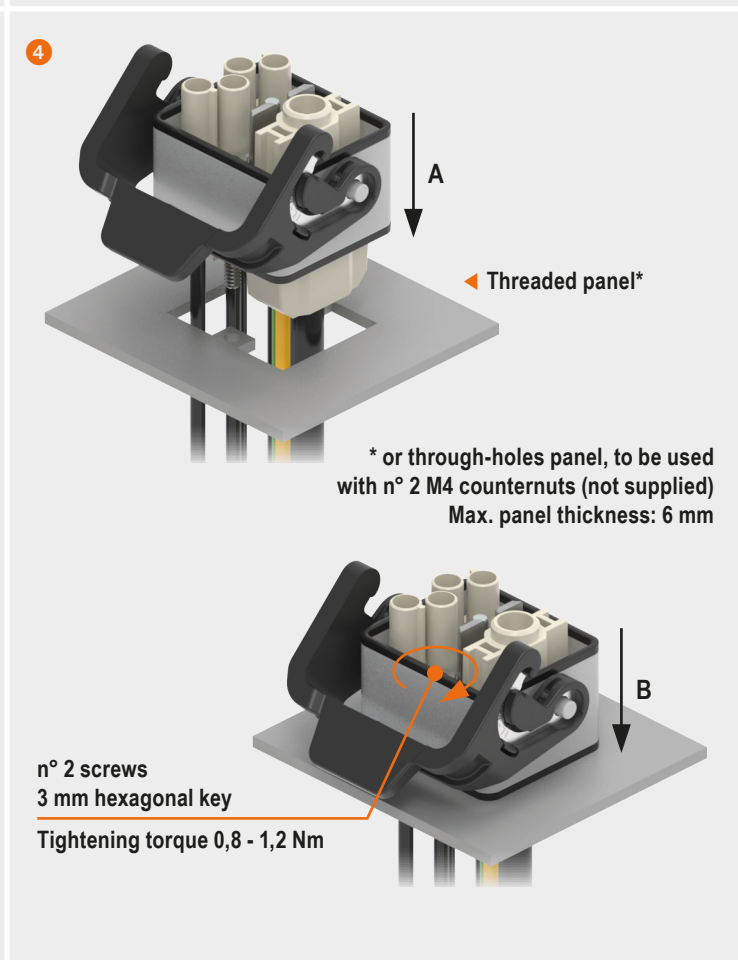
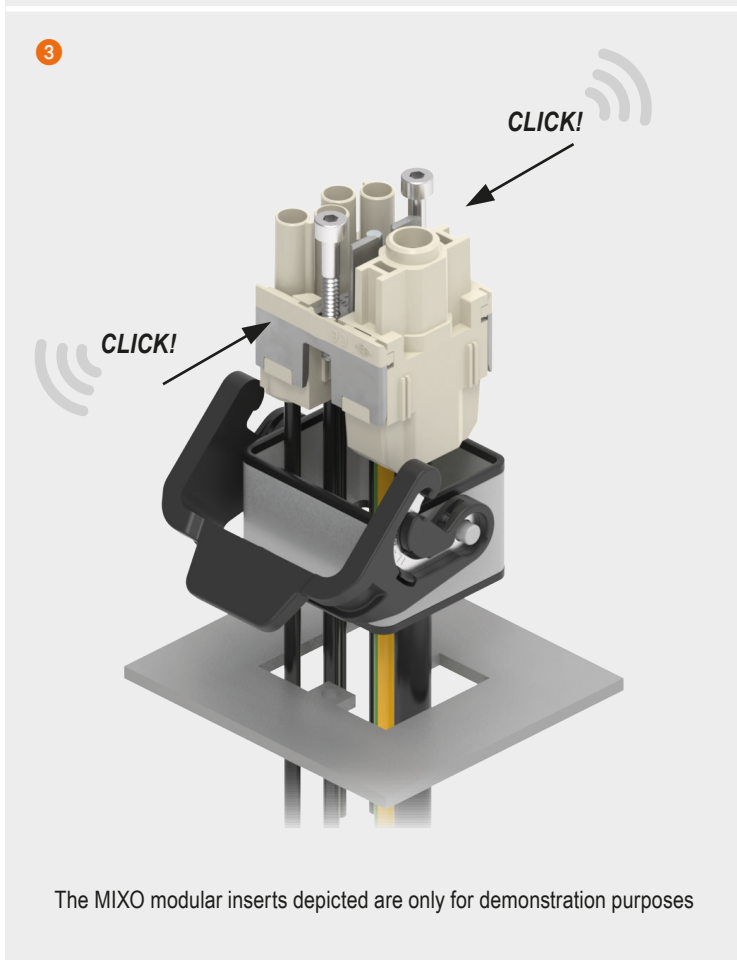
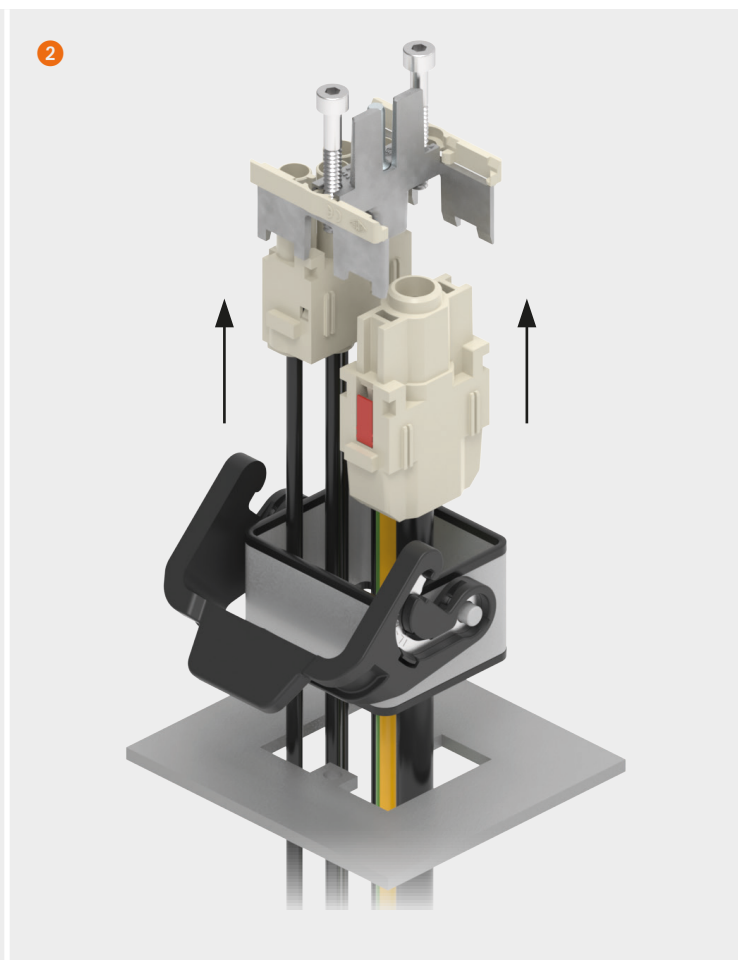
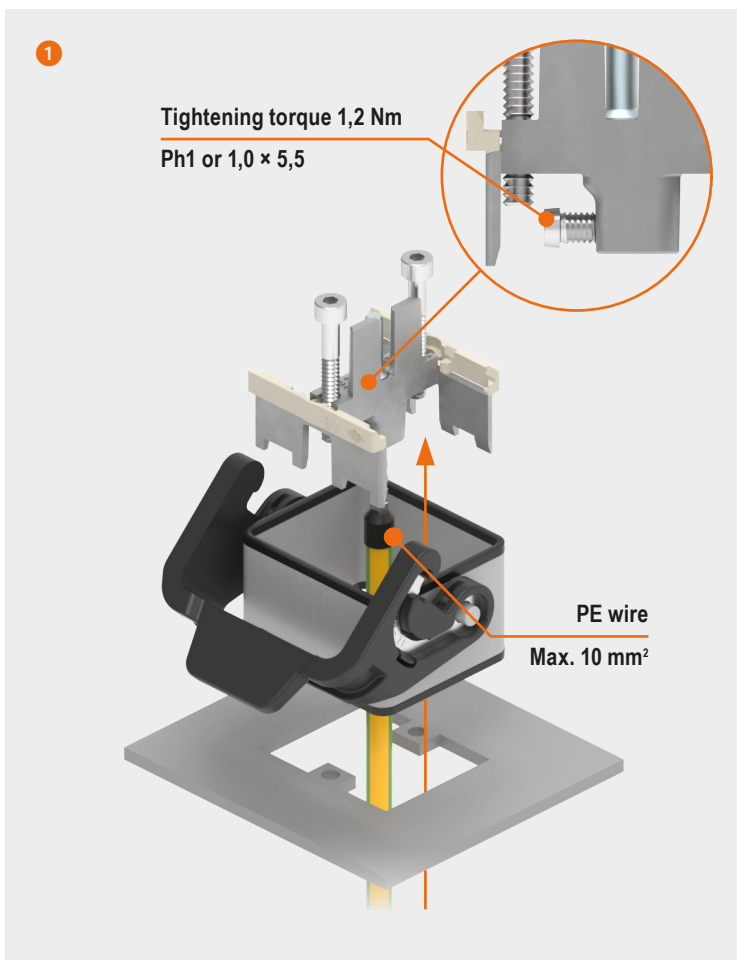

The MIXO modular inserts depicted are only for demonstration purposes

IL-BRID LOCKING LEVER

Standard enclosures with IL-BRID single locking lever sizes "57.27", "77.27" and "104.27"

CL..L – ML..L



**Proprietary design
with embedded stainless steel core
to protect industrial multipole
connections**



Find out more
www.ilme.com

TECHNICAL FEATURES

Among the enclosures' locking systems introduced by ILME in its product portfolio of connector enclosures, the **IL-BRID** mechanism, a locking lever in self-extinguishing thermoplastic material with a **stainless-steel core**, combines the technical characteristics of both these materials, for durable but **significantly low-wear design**.

The **IL-BRID locking lever** was initially introduced in the compact "**CZ**" and "**MZ**", sizes "49.16" and "66.16", enclosures series. More recently, with an adapted design it entered the ILME size "44.27", "57.27", "77.27" and "104.27" enclosures for standard applications (grey-coated) with single-lever on the smallest size "44.27" and double-lever on sizes "57.27", "77.27" and "104.27".

This range is now **further extended** to the single-lever versions for sizes "57.27", "77.27" and "104.27", with the "**CL**" and "**ML**" designations already in use, in the bulkhead or surface mounting housing or in the hood with lever versions.

Housings, either bulkhead mounting or surface mounting, are now available either with IL-BRID single lever (L in suffix of part No.) or with IL-BRID single lever **and with hinged, 3-position metal cover (LS** in suffix of part No.).

These new IL-BRID-equipped housings and hoods are **compatible** with the entire range of ILME enclosures with peg on short sides, offering an IP65 or IP66/IP69 degree of protection according to EN IEC 50529, depending on model and cable gland gasketing.

Surface mounting housing or hoods with levers of this **CL** – **ML** series, are **equipped with metric M cable entries**;

models with corresponding **Pg or NPT cable entries** are **available upon request**.

Main technical and functional characteristics:

- Q locking lever made of self-extinguishing thermoplastic material (UL approved) and stainless-steel core;
- Q improved closing mechanism with reduced wear on the pegs of the enclosure's counterpart;
- Q proprietary, ergonomic handle design for an easy opening and closing operation;
- Q enhanced stiffness of the longer handle by means of V-shaped ribs;
- Q IP65 or IP66/IP69 degree of protection according to EN IEC 60529 (depending on model);
- Q reduced occupation of space on the outer edges – compared to Class lever – thanks to a curved design;
- Q allow bulkhead mounting and surface mounting housings with hinged, 3-position metal covers (whereas double-lever do not).

✓ CERTIFICATIONS

- cURus (Type 12, 4, 4X), CQC, DNV, BV pending.
- **CE** and **UKCA** markings. EAC not applicable.
- **RoHS**: compliant.

▶ **V-shaped ribs**
to improve stiffness of handles



▶ **Soft closing**
1st touch



▶ **Strong hold**
2nd touch



CL..L - ML..L standard version with IL-BRID single lever

inserts:

insert	poles + ⊕	page:
CDD	42 poles + ⊕	78
CDS	18 poles + ⊕	-
CDSH	18 poles + ⊕	87
CNE	10 poles + ⊕	111
CSE	10 poles + ⊕	-
CSH	10 poles + ⊕	111
CSH S	10 poles + ⊕	123
CCE	10 poles + ⊕	131
CMSH	3 + 2 (aux) poles + ⊕	136
CMCE	3 + 2 (aux) poles + ⊕	137
CSS	10 poles + ⊕	149
CT, CTSE (16A)*	10 poles + ⊕	161
CQE	18 poles + ⊕	169
CX	8/24 poles + ⊕	194
MIXO	3 modules	262 - 317

* can be used only in bulkhead mounting housing

refer to CN.19 pages

page:

bulkhead mounting housings with single lever



FROM SEPTEMBER 2023

surface mounting housings with single lever



FROM SEPTEMBER 2023

description	part No.	entry M
with lever	CLI 10 L	
with lever and cover	CLI 10 LS	
with lever	MLP 10 L20	20
with lever	MLP 10 L220	20 × 2
with lever, high construction	MLAP 10 L32	32
with lever, high construction	MLAP 10 L232	32 × 2
with lever, high construction	MLAP 10 L40	40
with lever, high construction	MLAP 10 L240	40 × 2
with lever and cover	MLP 10 LS20	20
with lever and cover	MLP 10 LS220	20 × 2
with lever and cover, high construction	MLAP 10 LS32	32
with lever and cover, high construction	MLAP 10LS232	32 × 2
with lever and cover, high construction	MLAP 10 LS40	40
with lever and cover, high construction	MLAP 10LS240	40 × 2

panel cut-out for bulkhead mounting housings

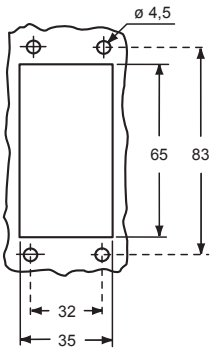

IMPORTANT NOTE: The enclosures ensure IP66/IP69 degree of protection (or IP65 for hinged cover versions) when mated and locked with the closing levers.

cURus
Type 4/4X/12 pending

- insulating cable gland or fittings without gasket
- cable gland with O-Ring gasket

CLI 10 L ▲

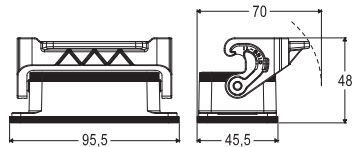

CLI 10 LS ●

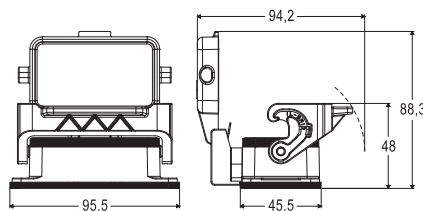

MLP 10 L

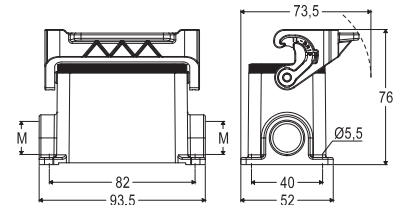

MLAP 10 LS ●

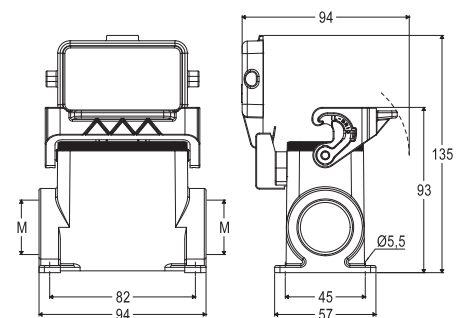

ML..L – MLA..L standard version with IL-BRID single lever

inserts:

CDD	42 poles + ⊕	78
CDS	18 poles + ⊕	-
CDSH	18 poles + ⊕	87
CNE	10 poles + ⊕	111
CSE	10 poles + ⊕	-
CSH	10 poles + ⊕	111
CSH S	10 poles + ⊕	123
CCE	10 poles + ⊕	131
CMSH	3 + 2 (aux) poles + ⊕	136
CMCE	3 + 2 (aux) poles + ⊕	137
CSS	10 poles + ⊕	149
CQE	18 poles + ⊕	169
CX	8/24 poles + ⊕	194
MIXO	3 modules	262 - 317

page:

hoods with single lever top entry



hoods with single lever side entry



refer to CN.19 pages

FROM SEPTEMBER 2023

FROM SEPTEMBER 2023

description	part No.	entry M	part No.	entry M
with lever, top entry	MLV 10 LG25	25		
with lever, top entry, high construction	MLAV 10 LG25	25		
with lever, top entry, high construction	MLAV 10 LG32	32		
with lever, top entry, high construction	MLAV 10 LG40	40		
with lever, side entry, high construction, without adapter ¹⁾			MLFO 10 LG40	40
with lever, top entry, high construction, without adapter ¹⁾	MLFV 10 LG25	25		
with lever, top entry, high construction, without adapter ¹⁾	MLFV 10 LG32	32		
with lever, top entry, high construction, without adapter ¹⁾	MLFV 10 LG40	40		

¹⁾ enclosure without adapter, threaded on the body, to be used only with a complete cable gland.

MLV 10 LG

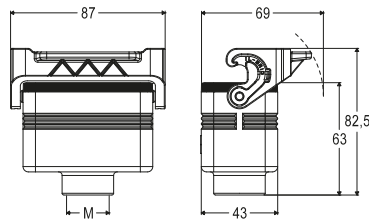

MLFO 10 LG

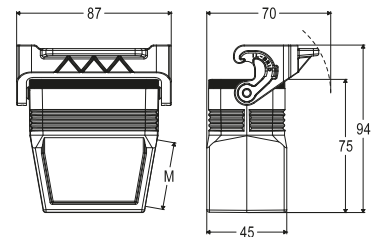

MLAV 10 LG

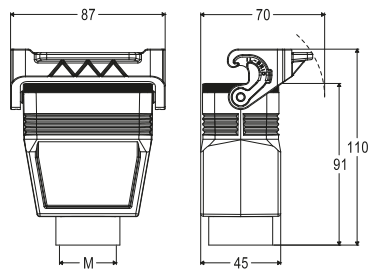

MLFV 10 LG

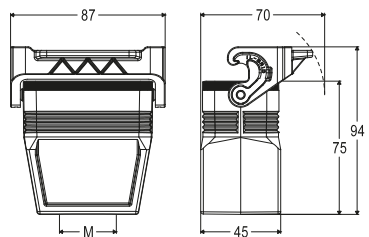

cURus
Type 4/4X/12 pending

insulating cable gland or fittings without gasket

cable gland with O-Ring gasket

CL..L – ML..L standard version with IL-BRID single lever

inserts:

insert	poles + ⊕	page
CD	40 poles + ⊕	70
CDD	72 poles + ⊕	79
CDS	27 poles + ⊕	-
CDSH	27 poles + ⊕	88
CNE	16 poles + ⊕	112
CSE	16 poles + ⊕	-
CSH	16 poles + ⊕	112
CSH S	16 poles + ⊕	124
CCE	16 poles + ⊕	132
CMSH, CMCE	6 + 2 (aux) poles + ⊕	138 - 139
CSS	16 poles + ⊕	150
CT, CTS (10A)*	40 poles + ⊕	156
CT, CTSE (16A)*	16 poles + ⊕	162
CQE	32 poles + ⊕	170
CQEE	40 poles + ⊕	176
CP	6 poles + ⊕	178
CX	6/12, 6/36 and 12/2 poles + ⊕	197 - 199
CX	4/0 and 4/2 poles + ⊕	200 - 201
MIXO	4 modules	262 - 317

* can be used only in bulkhead mounting housings

refer to CN.19 pages

page:

bulkhead mounting housings with single lever



FROM SEPTEMBER 2023

surface mounting housings with single lever



FROM SEPTEMBER 2023

description	part No.	entry M
with lever	CLI 16 L	
with lever and cover	CLI 16 LS	
with lever	MLP 16 L25	25
with lever	MLP 16 L225	25 × 2
with lever, high construction	MLAP 16 L32	32
with lever, high construction	MLAP 16 L232	32 × 2
with lever, high construction	MLAP 16 L40	40
with lever, high construction	MLAP 16 L240	40 × 2
with lever and cover	MLP 16 LS25	25
with lever and cover	MLP 16 LS225	25 × 2
with lever and cover, high construction	MLAP 16 LS32	32
with lever and cover, high construction	MLAP 16LS232	32 × 2
with lever and cover, high construction	MLAP 16 LS40	40
with lever and cover, high construction	MLAP 16LS240	40 × 2

panel cut-out for bulkhead mounting housings

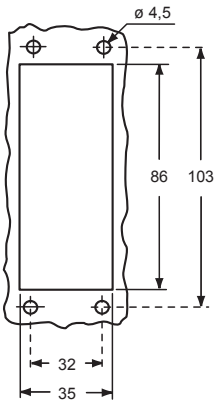

IMPORTANT NOTE: The enclosures ensure IP66/IP69 degree of protection (or IP65 for hinged cover versions) when mated and locked with the closing levers.

cURus
Type 4/4X/12 pending

- insulating cable gland or fittings without gasket
- cable gland with O-Ring gasket

CLI 16 L ▲

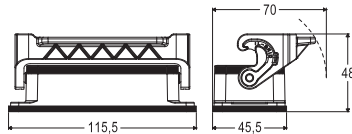

CLI 16 LS ●

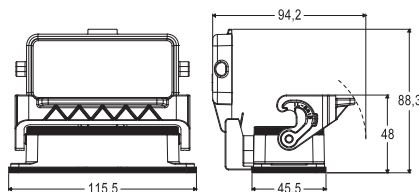

MLP 16 L

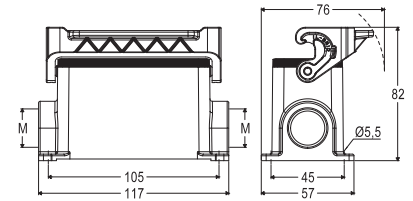

MLAP 16 LS ●

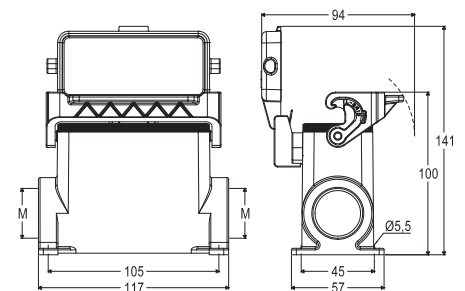

ML..L – MLA..L standard version with IL-BRID single lever

inserts:

		page:
CD	40 poles + ⊕	70
CDD	72 poles + ⊕	79
CDS	27 poles + ⊕	-
CDSH	27 poles + ⊕	88
CNE	16 poles + ⊕	112
CSE	16 poles + ⊕	-
CSH	16 poles + ⊕	112
CSH S	16 poles + ⊕	124
CCE	16 poles + ⊕	132
CMSH, CMCE	6 + 2 (aux) poles + ⊕	138 - 139
CSS	16 poles + ⊕	150
CQE	32 poles + ⊕	170
CQEE	40 poles + ⊕	176
CP	6 poles + ⊕	178
CX	6/12, 6/36 and 12/2 poles + ⊕	197 - 199
CX	4/0 and 4/2 poles + ⊕	200 - 201
MIXO	4 modules	262 - 317

refer to CN.19 pages

hoods with single lever top entry



FROM SEPTEMBER 2023

hoods with single lever side entry



FROM SEPTEMBER 2023

description	part No.	entry M	part No.	entry M
with lever, top entry	MLV 16 LG32	32		
with lever, top entry, high construction	MLAV 16 LG25	25		
with lever, top entry, high construction	MLAV 16 LG32	32		
with lever, top entry, high construction	MLAV 16 LG40	40		
with lever, side entry, high construction, without adapter ¹⁾			MLFO 16 LG40	40
with lever, top entry, high construction, without adapter ¹⁾	MLFV 16 LG25	25		
with lever, top entry, high construction, without adapter ¹⁾	MLFV 16 LG32	32		
with lever, top entry, high construction, without adapter ¹⁾	MLFV 16 LG40	40		

¹⁾ enclosure without adapter, threaded on the body, to be used only with a complete cable gland.

MLV 16 LG

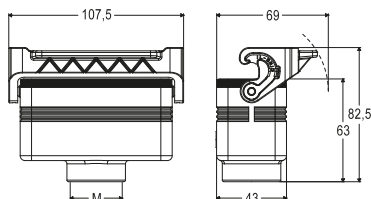

MLAV 16 LG

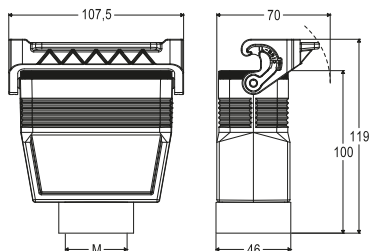

MLFV 16 LG

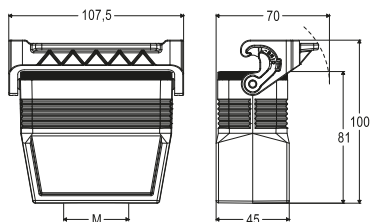

MLFO 16 LG

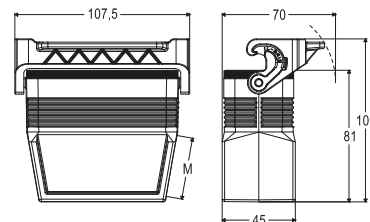

cURus
Type 4/4X/12 pending

insulating cable gland or fittings without gasket

cable gland with O-Ring gasket

CL..L – ML..L standard version with IL-BRID single lever

inserts:		page:
CD	64 poles + ⊕	72
CDD	108 poles + ⊕	81
CDS	42 poles + ⊕	-
CDSH	42 poles + ⊕	89
CNE	24 poles + ⊕	113
CSE	24 poles + ⊕	-
CSH	24 poles + ⊕	113
CSH S	24 poles + ⊕	125
CCE	24 poles + ⊕	133
CMSH	10 + 2 (aux) poles + ⊕	140
CMCE	10 + 2 (aux) poles + ⊕	141
CSS	24 poles + ⊕	151
CT, CTS (10A)*	64 poles + ⊕	157
CT, CTSE (16A)*	24 poles + ⊕	163
CQE	46 poles + ⊕	171
CQEE	64 poles + ⊕	177
CX	4/8 and 6/6 poles + ⊕	204, 206
MIXO	6 modules	262 - 317

* can be used only in bulkhead mounting housings

refer to CN.19 pages

bulkhead mounting housings with single lever



FROM SEPTEMBER 2023

surface mounting housings with single lever



FROM SEPTEMBER 2023

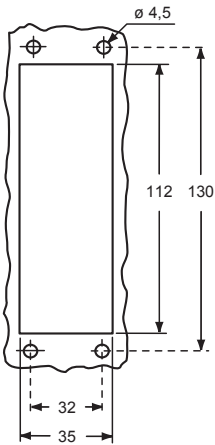

description	part No.	entry
with lever	CLI 24 L	
with lever and cover	CLI 24 LS	
with lever	MLP 24 L25	25
with lever	MLP 24 L225	25 × 2
with lever, high construction	MLAP 24 L32	32
with lever, high construction	MLAP 24 L232	32 × 2
with lever, high construction	MLAP 24 L40	40
with lever, high construction	MLAP 24 L240	40 × 2
with lever and cover	MLP 24 LS25	25
with lever and cover	MLP 24 LS225	25 × 2
with lever and cover, high construction	MLAP 24 LS32	32
with lever and cover, high construction	MLAP 24LS232	32 × 2
with lever and cover, high construction	MLAP 24 LS40	40
with lever and cover, high construction	MLAP 24LS240	40 × 2

panel cut-out for bulkhead mounting housings



IMPORTANT NOTE: The enclosures ensure IP66/IP69 degree of protection (or IP65 for hinged cover versions) when mated and locked with the closing levers.

cURus
Type 4/4X/12 pending

-  insulating cable gland or fittings without gasket
-  cable gland with O-Ring gasket

CLI 24 L ▲

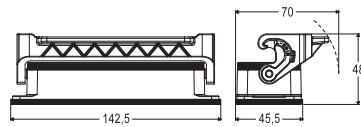

CLI 24 LS ●

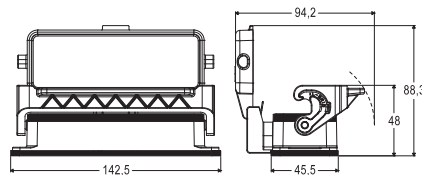

MLP 24 L

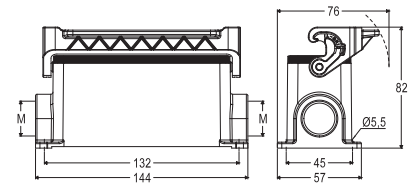

MLAP 24 LS ●

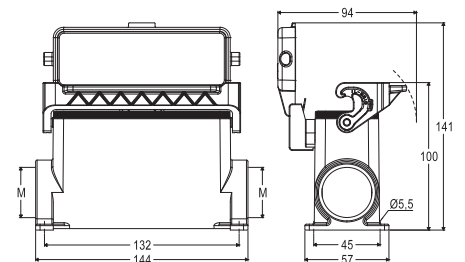

ML..L – MLA..L standard version with IL-BRID single lever

inserts:

CD	64 poles + ⊕	72
CDD	108 poles + ⊕	81
CDS	42 poles + ⊕	-
CDSH	42 poles + ⊕	89
CNE	24 poles + ⊕	113
CSE	24 poles + ⊕	-
CSH	24 poles + ⊕	113
CSH S	24 poles + ⊕	125
CCE	24 poles + ⊕	133
CMSH	10 + 2 (aux) poles + ⊕	140
CMCE	10 + 2 (aux) poles + ⊕	141
CSS	24 poles + ⊕	151
CQE	46 poles + ⊕	171
CQEE	64 poles + ⊕	177
CX	4/8 and 6/6 poles + ⊕	204, 206
MIXO	6 modules	262 - 317

page:

hoods with single lever top entry



hoods with single lever side entry



refer to CN.19 pages

FROM SEPTEMBER 2023

FROM SEPTEMBER 2023

description	part No.	entry M	part No.	entry M
with lever, top entry	MLV 24 LG32	32		
with lever, top entry, high construction	MLAV 24 LG25	25		
with lever, top entry, high construction	MLAV 24 LG32	32		
with lever, top entry, high construction	MLAV 24 LG40	40		
with lever, side entry, high construction, without adapter ¹⁾			MLFO 24 LG40	40
with lever, top entry, high construction, without adapter ¹⁾	MLFV 24 LG25	25		
with lever, top entry, high construction, without adapter ¹⁾	MLFV 24 LG32	32		
with lever, top entry, high construction, without adapter ¹⁾	MLFV 24 LG40	40		

¹⁾ enclosure without adapter, threaded on the body, to be used only with a complete cable gland.

MLV 24 LG

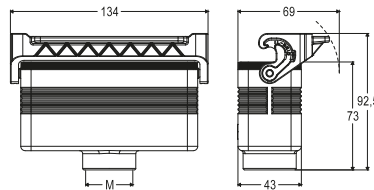

MLFO 24 LG

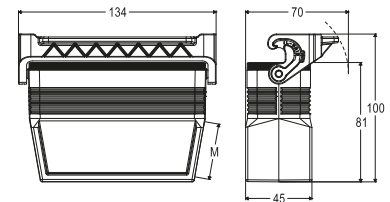

MLAV 24 LG

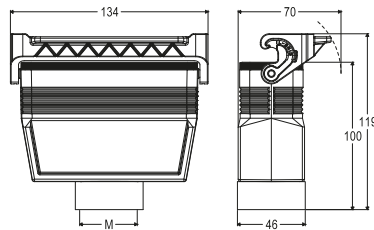

MLFV 24 LG

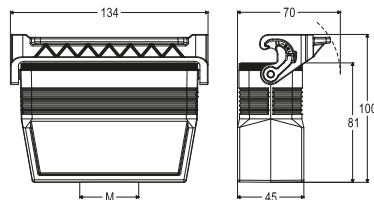

cURus
Type 4/4X/12 pending



insulating cable gland or fittings without gasket



cable gland with O-Ring gasket

IP68 COVERS FOR SCREW LOCKING

For IP68 CG-MG hoods

CGC..G



The new **CGC..G** (for screw locking) **IP68 metal covers**, for the **series CG/MG IP66/IP68/IP69 hoods** of all sizes (“44.27” through “104.27”) enable the continue protection of the connector installed in the corresponding hood to the same degree, once locked.

This becomes particularly useful when the heavy-duty cable assembly remains unmated for long time, thus potentially exposed to environmental pollution, weather agents (wind, sand, rain, snow, sun) and to mechanical shocks.

For the fixing to hoods, around the outgoing cable, these covers are equipped with a robust stainless-steel cord, loop-terminated.

Made by die cast aluminium alloy, corrosion resistant, coated by epoxy thermosetting powder, black colour.

Versions with suffix G, for screw-locking hoods, are equipped with corresponding stainless-steel nuts.

✓ CERTIFICATIONS

- cURus (Type 12, 4, 4X), CQC, DNV, BV pending.
- **CE** and **UK CA** markings. EAC not applicable.
- **RoHS**: compliant.

CGC..G IP68 covers

IP68 hoods:

- CG/MG, size "44.27"
- CG/MG, size "57.27"
- CG/MG, size "77.27"
- CG/MG, size "104.27"

page:

- 633
- 637
- 641
- 645

covers

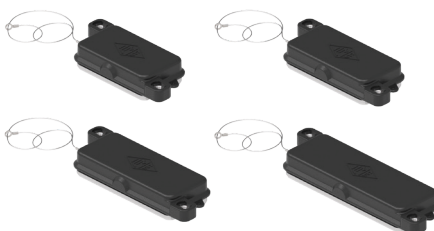

FROM APRIL 2023

refer to CN.19 pages

description	part No.
-------------	----------

for screw locking, size "44.27"
 for screw locking, size "57.27"
 for screw locking, size "77.27"
 for screw locking, size "104.27"

- [CGC 06 G](#)
- [CGC 10 G](#)
- [CGC 16 G](#)
- [CGC 24 G](#)

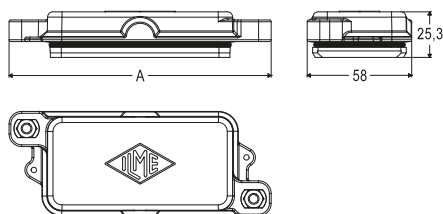
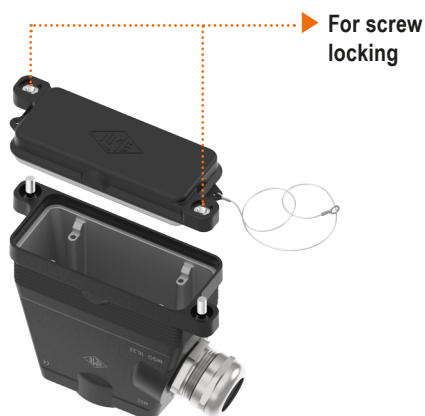

part No.	polarity	A
CGC 06 G	06	132,5
CGC 10 G	10	145,5
CGC 16 G	16	165,5
CGC 24 G	24	192,5

cURus
 Type 4/4X/12 pending



according to IEC/EN 60529

For fixing on hoods

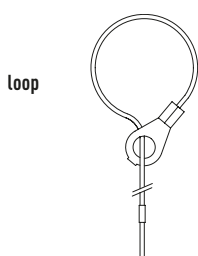

Find out more
www.ilme.com

Visit **ilme.com** website to discover all the main features:



Technical datasheets
to get all the information about our products.



Application pages
to focus on installation locations, field requirements and technical details.



Download Area
to find all the useful files in a click.



Get into our **Configurator** to easily find the right solution that fits your needs



search

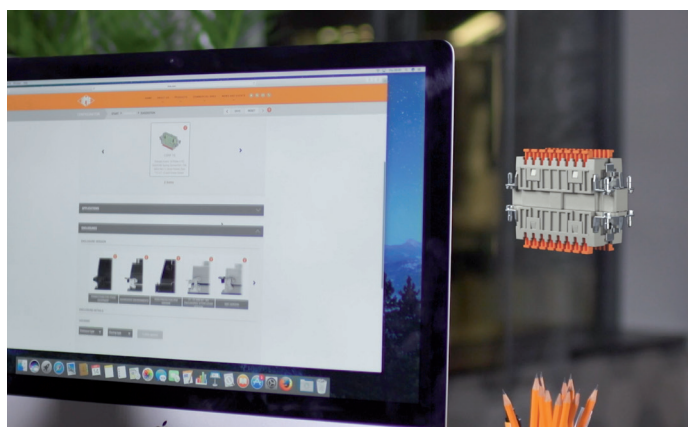

Over 50 million connector combinations.

choose

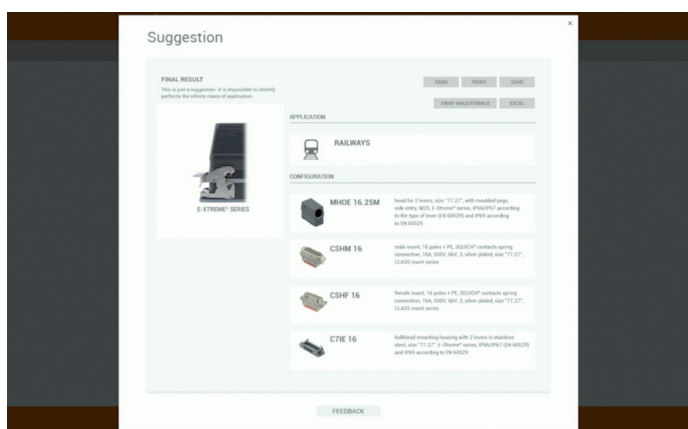

Easy selection of individual parts for key applications and recommendations for custom environmental conditions.

download

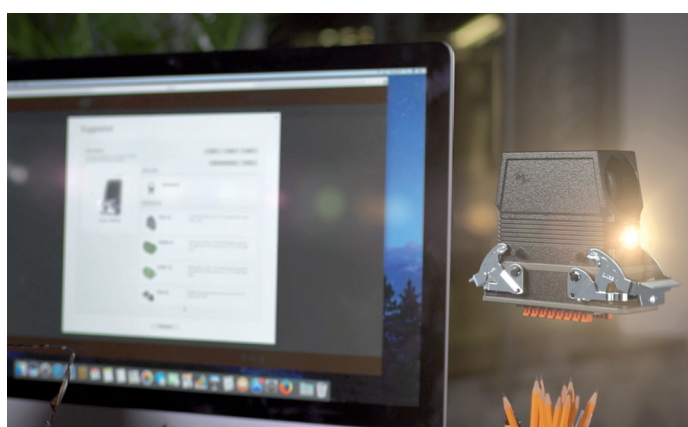

Smart suggestion to get the most suitable configuration.

C

C13D 16 C.....	54, 55
C13D 25 C.....	54, 55
C13D 35 C.....	54, 55
C13D 50 C.....	54, 55
C13D 70 C.....	54, 55
C13D 95 C.....	54, 55
C13D 120 C.....	54, 55
C13PZ C.....	54
C13PZ EL AU.....	55
C13PZ EL EU.....	55
C13PZ EL UK.....	55
C13PZ EL US.....	55
C30FA 16.....	43, 45
C30FA 25.....	43, 45
C30FA 35.....	43, 45
C30FA 50.....	43, 45
C30FA 70.....	43, 45
C30FA 95.....	43, 45
C30FA 120.....	43, 45
C30MA 16.....	45
C30MA 16 P.....	43
C30MA 25.....	45
C30MA 25 P.....	43
C30MA 35.....	45
C30MA 35 P.....	43
C30MA 50.....	45
C30MA 50 P.....	43
C30MA 70.....	45
C30MA 70 P.....	43
C30MA 95.....	45
C30MA 95 P.....	43
C30MA 120.....	45
C30MA 120 P.....	43
CCES.....	67
CCPR RN.....	67
CDFA 0.3.....	63
CDFA 0.5.....	63
CDFA 0.7.....	63
CDFA 1.0.....	63
CDFA 1.5.....	63
CDFA 2.5.....	63
CDFD 0.3.....	63
CDFD 0.5.....	63
CDFD 0.7.....	63
CDFD 1.0.....	63
CDFD 1.5.....	63
CDFD 2.5.....	63
CDMA 0.3.....	63
CDMA 0.5.....	63
CDMA 0.7.....	63
CDMA 1.0.....	63
CDMA 1.5.....	63
CDMA 2.5.....	63
CDMD 0.3.....	63
CDMD 0.5.....	63
CDMD 0.7.....	63
CDMD 1.0.....	63
CDMD 1.5.....	63
CDMD 2.5.....	63
CDYF 07.....	18
CDYF 08.....	19
CDYM 07.....	18
CDYM 08.....	19
CGC 06 G.....	89
CGC 10 G.....	89
CGC 16 G.....	89
CGC 24 G.....	89
CKR 65.....	71
CKR 65 D.....	71
CLI 10 L.....	82
CLI 10 LS.....	82
CLI 16 L.....	84
CLI 16 LS.....	84
CLI 24 L.....	86
CLI 24 LS.....	86
COMPES B.....	58
CQEYF 10.....	24
CQEYF 18.....	25
CQEYF 32.....	26, 28
CQEYF 32 N.....	28
CQEYF 46.....	27, 29
CQEYF 46 N.....	29
CQEYM 10.....	24
CQEYM 18.....	25
CQEYM 32.....	26, 28
CQEYM 32 N.....	28
CQEYM 46.....	27, 29
CQEYM 46 N.....	29
CQF 04/2E.....	62
CQM 04/2E.....	62
CR Q08E.....	24*
CX 01 30AF.....	50
CX 01 30AM.....	50
CX 01 30F.....	42
CX 01 30M.....	42
CX 01 30PEAF.....	52
CX 01 30PEAM.....	52
CX 01 30PEF.....	44
CX 01 30PEM.....	44
CX 01B 30F.....	42
CX 01B 30M.....	42
CX 01B 30PEF.....	44
CX 01B 30PEM.....	44
CX 02 MPBF.....	58
CX 02 MPBM.....	58
CX 8.0 MPF.....	59
CX 8.0 MPM.....	59
CX 8.0 MPQF.....	59
CX 8.0 MPQM.....	59
CX 8.0 MPQV.....	59
CX 8.0 MPV.....	59
CX 10 MPF.....	59
CX 10 MPM.....	59
CX 10 MPQF.....	59
CX 10 MPQM.....	59
CX 10 MPQV.....	59
CX 10 MPV.....	59
CX 12 DYF.....	21, 39
CX 12 DYM.....	21, 39
CXA 02 I.....	76
CXFA 1.5.....	63
CXFA 2.5.....	63
CXFA 4.0.....	63
CXFA 6.0.....	63
CXMA 1.5.....	63
CXMA 2.5.....	63
CXMA 4.0.....	63
CXMA 6.0.....	63
CXP 02 C.....	77
CXP 02 CLG.....	77
M	
MKAG VA25.....	70
MKAS VA25.....	71
MKA VA25.....	70
MKAW VA25.....	71
MLAP 10 L32.....	82
MLAP 10 L40.....	82
MLAP 10 L232.....	82
MLAP 10 L240.....	82
MLAP 10 LS32.....	82
MLAP 10 LS40.....	82
MLAP 10LS232.....	82

* These items are also shown in various sections throughout the catalogue

MLAP 10LS240.....	82
MLAP 16 L32.....	84
MLAP 16 L40.....	84
MLAP 16 L232.....	84
MLAP 16 L240.....	84
MLAP 16 LS32.....	84
MLAP 16 LS40.....	84
MLAP 16LS232.....	84
MLAP 16LS240.....	84
MLAP 24 L32.....	86
MLAP 24 L40.....	86
MLAP 24 L232.....	86
MLAP 24 L240.....	86
MLAP 24 LS32.....	86
MLAP 24 LS40.....	86
MLAP 24LS232.....	86
MLAP 24LS240.....	86
MLAV 10 LG25.....	83
MLAV 10 LG32.....	83
MLAV 10 LG40.....	83
MLAV 16 LG25.....	85
MLAV 16 LG32.....	85
MLAV 16 LG40.....	85
MLAV 24 LG25.....	87
MLAV 24 LG32.....	87
MLAV 24 LG40.....	87
MLFO 10 LG40.....	83
MLFO 16 LG40.....	85
MLFO 24 LG40.....	87
MLFV 10 LG25.....	83
MLFV 10 LG32.....	83
MLFV 10 LG40.....	83
MLFV 16 LG25.....	85
MLFV 16 LG32.....	85
MLFV 16 LG40.....	85
MLFV 24 LG25.....	87
MLFV 24 LG32.....	87
MLFV 24 LG40.....	87
MLP 10 L20.....	82
MLP 10 L220.....	82
MLP 10 LS20.....	82
MLP 10 LS220.....	82
MLP 16 L25.....	84
MLP 16 L225.....	84
MLP 16 LS25.....	84
MLP 16 LS225.....	84
MLP 24 L25.....	86
MLP 24 L225.....	86
MLP 24 LS25.....	86

MLP 24 LS225.....	86
MLV 10 LG25.....	83
MLV 16 LG32.....	85
MLV 24 LG32.....	87
MXA 02 O25.....	76
MXA 02 O32.....	76
MXA 02 V25.....	76
MXA 02 V32.....	76

S

SDFA 1.0.....	66
SDFA 1.0R.....	66
SDFA 2.5.....	66
SDFA 2.5R.....	66
SDMA 1.0.....	66
SDMA 1.0R.....	66
SDMA 2.5.....	66
SDMA 2.5R.....	66
SDPZ TP.....	67

* These items are also shown in various sections throughout the catalogue

Worldwide Sales Organization

Headquarters

ILME S.p.A.

Via M.A. Colonna, 9
20149 Milano, Italia
T +39 0234560522
info@ilme.com

France

ILME FRANCE S.A.R.L.

431 rue Roland Garros
Parc d'Activités de l'Aéroport
42160 Andrézieux-Bouthéon
T +33 04 7736 2336
ilme-france@ilme.fr

Sweden

and Nordic Countries

ILME NORDIC AB

Transportvägen 18
246 42 Löddeköpinge
T +46 4618 2800
info@ilme.se

Czech Republic

Representative Office

ILME S.p.A.

Business Center Rokytka
Sokolovská 270/201
Vysocany, Praha 9, 190 00
info@ilme.cz

Japan

ILME JAPAN CO. LTD.

K.I.B.C. Bldg 5-2
Minatojima Minamimachi 5-Chome
Chuo-Ku, Kobe 650-0047
T +81 78 302 2005
info@ilmejapan.co.jp

Germany

ILME GmbH

Max-Planck-Straße 12
51674 Wiehl
T +49 (0)2261 7955 0
technik@ilme.de

United Kingdom

ILME UK LIMITED

50 Evans Road, Venture Point
Speke, Liverpool L24 9PB
T +44 0151 336 9321
sales@ilmeuk.co.uk

China

ILME CHINA CO. LTD.

Room 101, Building 3
188 Xinjunhuan Road, Minhang
Shanghai 201114
T +86 21 6248 9961
info@ilmechina.com

South Korea

ILME KOREA CO.

714, DaeRyung Technotown 20th
5 Gasan Digital 1-Ro, GeumCheon-Gu
Seoul 08594
T +82-2-2225-8432
sales@ilme.kr

www.ilme.com



ILME S.p.A.
Via M.A. Colonna 9
20149 Milano, Italy
www.ilme.com

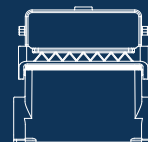
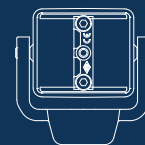
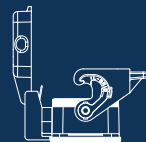
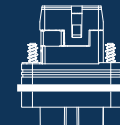
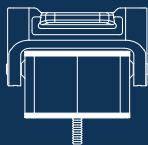
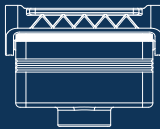
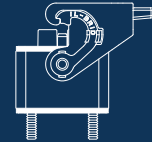
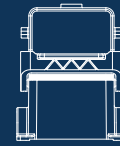
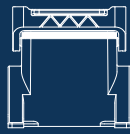
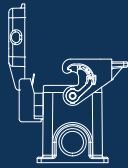
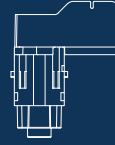

XDGPDT23 323



8 015174 1298148



catalogues