

# Comb Busbar / Jumpers for Miniature Circuit Breakers and Fuse Holders

UL 489 & UL 1077

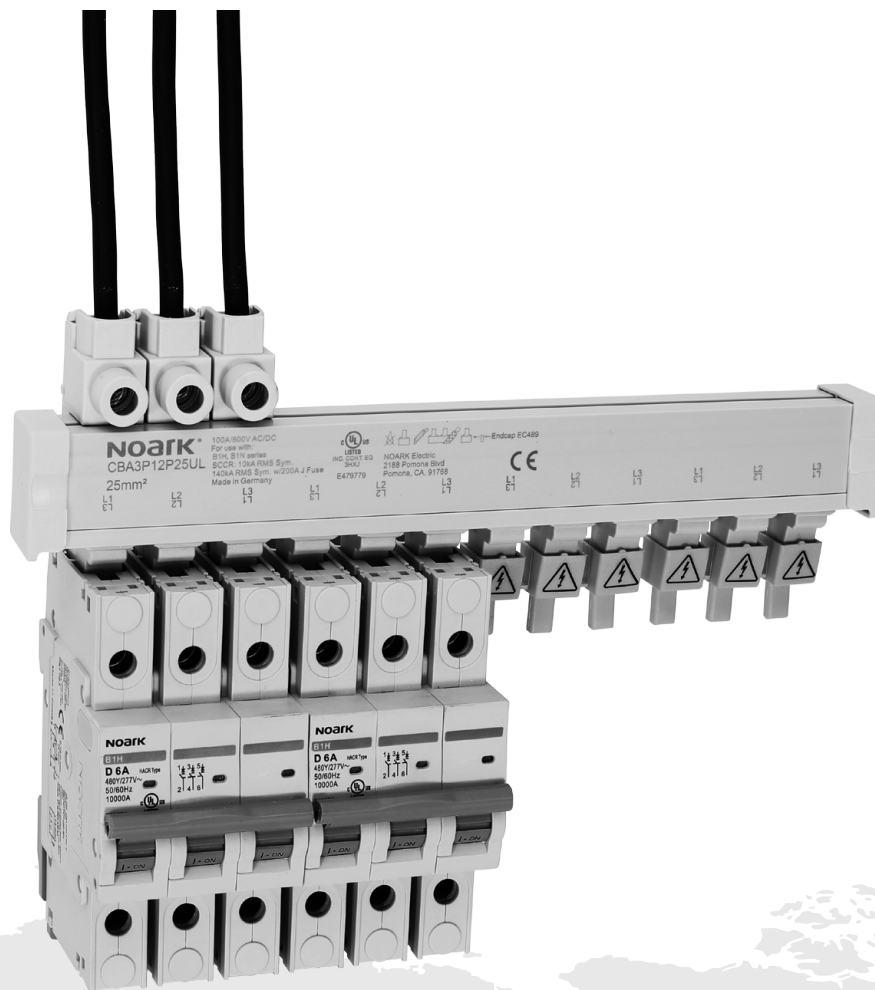

# Comb Bus Bars

## NOARK UL 489/1077

### Features

#### UL 489 Miniature Circuit Breakers Comb Bus Bar:

- Available for 1, 2 and 3 poles
- Available in 80 A and 100 A ratings
- Voltage ratings:
  - 1 pole: 1,000 Vac/dc
  - 2 and 3 poles: 600 Vac/dc
- Center Feed rating up to 200 A (two 115 A terminals required per pole)
- Feeder Terminal options allow for Top or Bottom Feed as standard
- Cuttable design allows for maximum flexibility and less waste
- Finger safe design with available Protective Caps for unused terminals

#### UL 1077 Supplementary Protectors Comb Bus Bar:

- Available for 1, 2 and 3 poles
- Available in 80 A and 100 A ratings
- Voltage ratings:
  - 1 pole: 600 Vac, 1,000 Vdc
  - 2 and 3 poles: 600 Vac/dc
- Center Feed rating up to 200 A (two incoming terminals required per pole)
- Feeder Terminal options allow for Top or Bottom Feed
- Cuttable design allows for maximum flexibility and less waste
- Finger safe design with available Protective Caps for unused terminals

### Certifications



- UL 489/508 Listed
- CE Compliant
- RoHS Compliant



# Comb Bus Bars

## UL 489/1077 Selection Guide

### Selection Guide

| CB          | A        | 1P          | 06P                            | 18                            | UL                     |
|-------------|----------|-------------|--------------------------------|-------------------------------|------------------------|
| Description | UL Rated | Pole        | Pin Type                       | Cross Section mm <sup>2</sup> | Device Category        |
| Bus Bar     | A: 489   | 1P: 1 Pole  | 06P: 6 Pins                    | 18: 18 (80 A)                 | UL: For UL 489 MCB     |
|             | B: 1077  | 2P: 2 Poles | 12P: 12 Pins                   | 25: 25 (100 A)                | Blank: For UL 1077 MCB |
|             |          | 3P: 3 Poles | 18P: 18 Pins                   |                               |                        |
|             |          |             | 56P: 56 Pins (for 2-pole only) |                               |                        |
|             |          |             | 57P: 57 Pins                   |                               |                        |

# Comb Bus Bars

## UL 489/1077 Specifications and Dimensions

|                    |   | UL 489      |             | UL 1077 |             |
|--------------------|---|-------------|-------------|---------|-------------|
|                    |   | 1 Pole      | 2 & 3 Poles | 1 Pole  | 2 & 3 Poles |
| Voltage Ratings    | Maximum AC Voltage (Vac)                              | 1,000       | 600         | 600     |             |
|                    | Maximum DC Voltage (Vdc)                              |             |             | 1,000   | 600         |
| Current Ratings    | Maximum Current 18 mm <sup>2</sup> Cross Sections (A) | End Feed    | 80          |         |             |
|                    |   | Center Feed | 160         |         |             |
|                    | Maximum Current 25 mm <sup>2</sup> Cross Sections (A) | End Feed    | 100         |         |             |
|                    |   | Center Feed | 200         |         |             |
| Protection Class   |   | IP 20       |             |         |             |
| J Fuse Rating (kA) |   | 14          |             | 10      |             |

## Dimensions

### CBA UL 489

Unit: in. [mm]

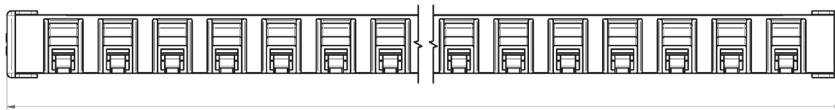

6 pins: 5.01<sup>+0.08</sup> [127.2<sup>-1</sup>]  
 12 pins: 9.26<sup>+0.08</sup> [235.2<sup>-1</sup>]  
 18 pins: 13.51<sup>+0.08</sup> [343.2<sup>-1</sup>]  
 56 pins: 40.32<sup>+0.08</sup> [1024.2<sup>-1</sup>]  
 57 pins: 41.03<sup>+0.08</sup> [1042.2<sup>-1</sup>]

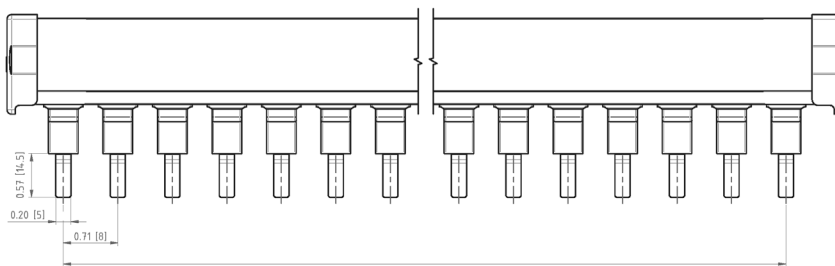

6 pins: 3.54 [90]  
 12 pins: 7.8 [198]  
 18 pins: 12.05 [306]  
 56 pins: 38.98 [990]  
 57 pins: 39.69 [1008]

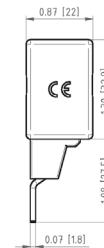

# Comb Bus Bars

## UL 489/1077 Accessories: Dimensions

**CBB**  
**UL 1077**  
Unit: in. [mm]

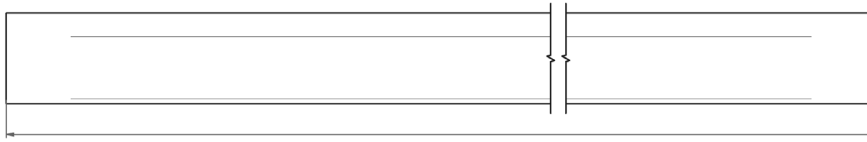

6 pins: 4.17<sup>+0.08</sup> [106<sup>-1</sup>]  
12 pins: 8.43<sup>+0.08</sup> [214<sup>-2</sup>]  
18 pins: 12.68<sup>+0.08</sup> [322<sup>-2</sup>]  
57 pins: 40.31<sup>+0.08</sup> [1024<sup>-1</sup>]

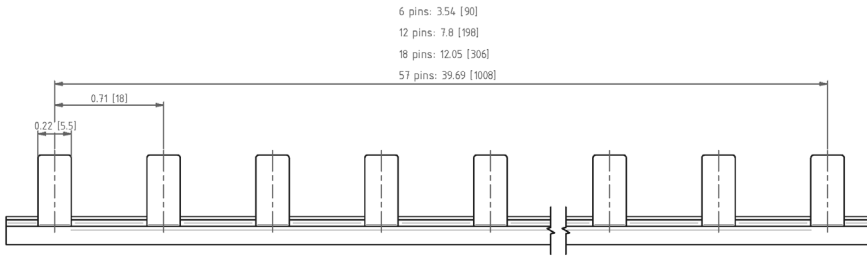

6 pins: 3.54 [90]  
12 pins: 7.8 [198]  
18 pins: 12.05 [306]  
57 pins: 39.69 [1008]

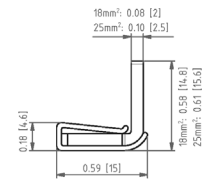

6 pins: 4.21<sup>+0.08</sup> [107<sup>-1</sup>]  
12 pins: 8.46<sup>+0.08</sup> [215<sup>-1</sup>]  
18 pins: 12.72<sup>+0.08</sup> [323<sup>-1</sup>]  
56 pins: 39.65<sup>+0.08</sup> [1007<sup>-1</sup>]  
57 pins: 40.35<sup>+0.08</sup> [1025<sup>-1</sup>]

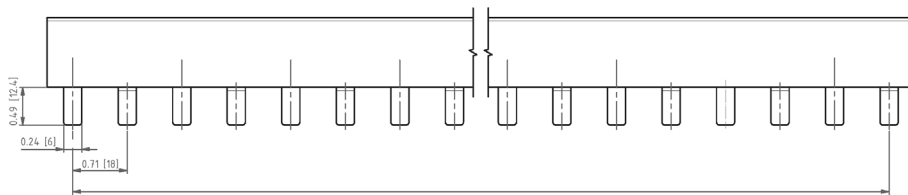

6 pins: 3.54 [90]  
12 pins: 7.8 [198]  
18 pins: 12.05 [306]  
56 pins: 38.98 [990]  
57 pins: 39.69 [1008]

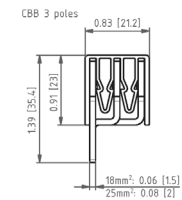
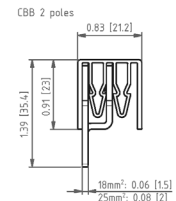

# Comb Bus Bars

## UL 489/1077 Accessories: Selection Guide

### Feeder Terminal UL 1077

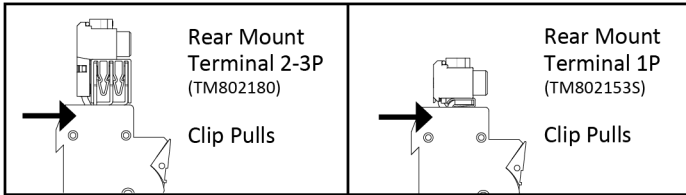

Terminal installed **behind** bus bar allows for reduced depth

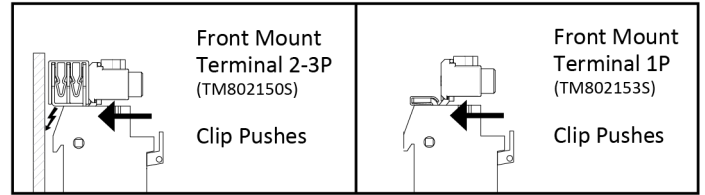

Terminal installed **in front of** bus bar allows for reduced height

## Selection Guide

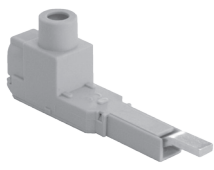

Top Feed  
FD35UL

| FD                | 50                                      |                |
|-------------------|---|----------------|
| Description       | Dimensions                              | UL             |
| FD: Feed Terminal | 35: 35 mm <sup>2</sup><br>(Top Feed)    | UL 489 / 489A  |
|                   | 50: 50 mm <sup>2</sup><br>(Bottom Feed) | Blank: UL 1077 |



Bottom Feed  
(FD50)



TC8021  
(Top Mount)

| TM                     | 8021          | 50S                               | EC          | 489           | 1           |
|------------------------|---------------|-----------------------------------|-------------|---------------|-------------|
| Description            | UL            | Poles                             | Description | UL            | Pole        |
| TM: Top Mount Terminal | 8021: UL 1077 | 50S: 1 Pole<br>(Rear Mount)       | EC: End Cap | UL 489 / 489A | 1: 1 Pole   |
|                        |               | 53S: 1/2/3 Poles<br>(Front Mount) |             | UL 1077       | 3: 2-3 Pole |
|                        |               | 80: 2/3 Poles<br>(Rear Mount)     |             |               |             |



EC489/1077  
(End Cap)

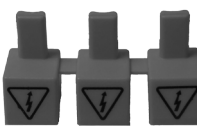

PC489  
(Protective Cap UL 489)

| PC                 | 489           |
|--------------------|---------------|
| Description        | UL            |
| PC: Protective Cap | UL 489 / 489A |
|                    | UL 1077       |



PC1077  
(Protective Cap UL 1077)

# Comb Bus Bars

## UL 489/1077 Comb Bus Bar Installation Guide

### CBA Accessories

UL 489

Unit: in. [mm]

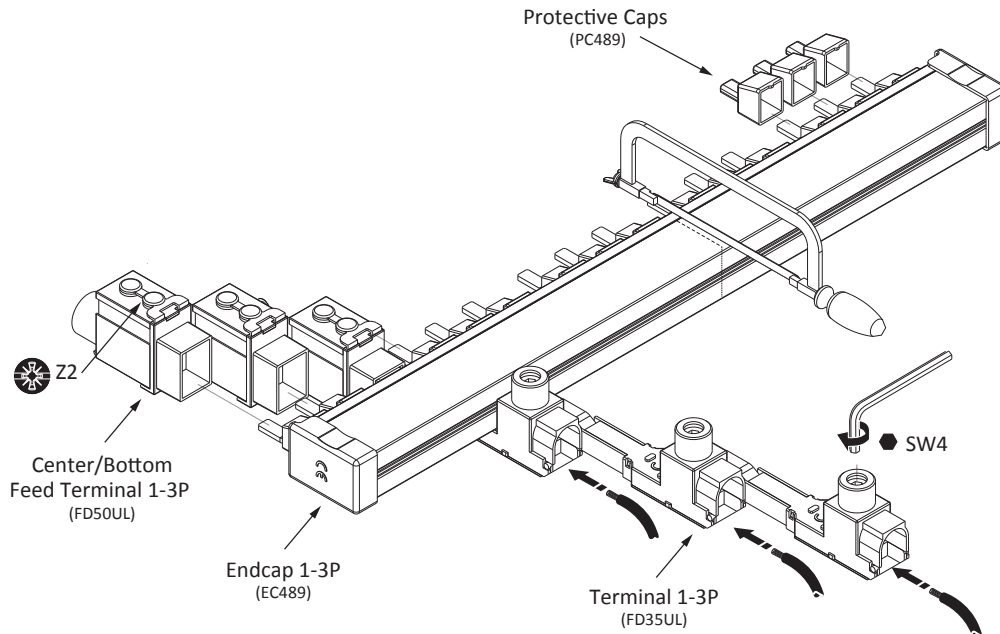

### CBB Accessories

UL 1077

Unit: in. [mm]

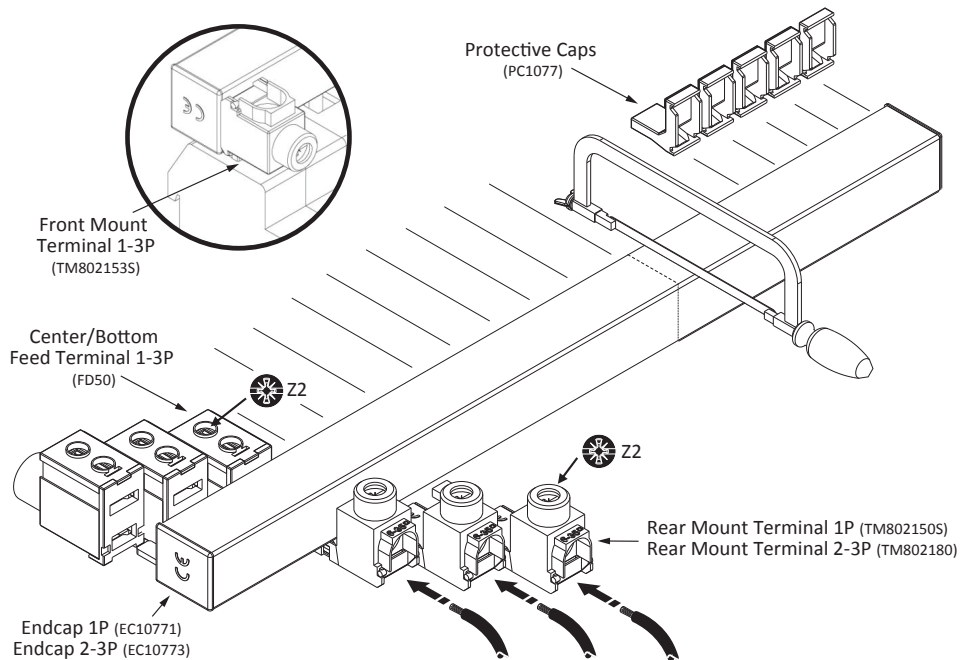

# Comb Bus Bars

## UL 489/1077 Ordering Guide

|                | Product      | Part Number | Description          | Poles                | Pins    | Cross Section      |                    |
|----------------|--------------|-------------|----------------------|----------------------|---------|--------------------|--------------------|
| <b>UL 489</b>  | CBA1P06P18UL | 1001252     | Comb Bus Bar         | 1                    | 6 pins  | 18 mm <sup>2</sup> |                    |
|                | CBA1P12P18UL | 1001253     | Comb Bus Bar         | 1                    | 12 pins | 18 mm <sup>2</sup> |                    |
|                | CBA1P18P18UL | 1001254     | Comb Bus Bar         | 1                    | 18 pins | 18 mm <sup>2</sup> |                    |
|                | CBA1P57P18UL | 1001255     | Comb Bus Bar         | 1                    | 57 pins | 18 mm <sup>2</sup> |                    |
|                | CBA1P06P25UL | 1001256     | Comb Bus Bar         | 1                    | 6 pins  | 25 mm <sup>2</sup> |                    |
|                | CBA1P12P25UL | 1001257     | Comb Bus Bar         | 1                    | 12 pins | 25 mm <sup>2</sup> |                    |
|                | CBA1P18P25UL | 1001258     | Comb Bus Bar         | 1                    | 18 pins | 25 mm <sup>2</sup> |                    |
|                | CBA1P57P25UL | 1001259     | Comb Bus Bar         | 1                    | 57 pins | 25 mm <sup>2</sup> |                    |
|                | CBA2P06P18UL | 1001260     | Comb Bus Bar         | 2                    | 6 pins  | 18 mm <sup>2</sup> |                    |
|                | CBA2P12P18UL | 1001261     | Comb Bus Bar         | 2                    | 12 pins | 18 mm <sup>2</sup> |                    |
|                | CBA2P18P18UL | 1001262     | Comb Bus Bar         | 2                    | 18 pins | 18 mm <sup>2</sup> |                    |
|                | CBA2P56P18UL | 1001263     | Comb Bus Bar         | 2                    | 56 pins | 18 mm <sup>2</sup> |                    |
|                | CBA2P06P25UL | 1001264     | Comb Bus Bar         | 2                    | 6 pins  | 25 mm <sup>2</sup> |                    |
|                | CBA2P12P25UL | 1001265     | Comb Bus Bar         | 2                    | 12 pins | 25 mm <sup>2</sup> |                    |
|                | CBA2P18P25UL | 1001266     | Comb Bus Bar         | 2                    | 18 pins | 25 mm <sup>2</sup> |                    |
|                | CBA2P56P25UL | 1001267     | Comb Bus Bar         | 2                    | 56 pins | 25 mm <sup>2</sup> |                    |
|                | CBA3P06P18UL | 1001268     | Comb Bus Bar         | 3                    | 6 pins  | 18 mm <sup>2</sup> |                    |
|                | CBA3P12P18UL | 1001269     | Comb Bus Bar         | 3                    | 12 pins | 18 mm <sup>2</sup> |                    |
|                | CBA3P18P18UL | 1001270     | Comb Bus Bar         | 3                    | 18 pins | 18 mm <sup>2</sup> |                    |
|                | CBA3P57P18UL | 1001271     | Comb Bus Bar         | 3                    | 57 pins | 18 mm <sup>2</sup> |                    |
|                | CBA3P06P25UL | 1001272     | Comb Bus Bar         | 3                    | 6 pins  | 25 mm <sup>2</sup> |                    |
|                | CBA3P12P25UL | 1001273     | Comb Bus Bar         | 3                    | 12 pins | 25 mm <sup>2</sup> |                    |
|                | CBA3P18P25UL | 1001274     | Comb Bus Bar         | 3                    | 18 pins | 25 mm <sup>2</sup> |                    |
|                | CBA3P57P25UL | 1001275     | Comb Bus Bar         | 3                    | 57 pins | 25 mm <sup>2</sup> |                    |
|                | FD35UL       | 1001276     | Top Feed Terminal    | -                    | -       | 35 mm <sup>2</sup> |                    |
|                | FD50UL       | 1002078     | Bottom Feed Terminal | -                    | -       | 50 mm <sup>2</sup> |                    |
|                | EC489        | 1002077     | End Cap              | 1-3                  | -       | -                  |                    |
|                | PC489        | 1002079     | Protective Cap       | -                    | -       | -                  |                    |
| <b>UL 1077</b> | CBB1P06P18   | 1002043     | Comb Bus Bar         | 1                    | 6 pins  | 18 mm <sup>2</sup> |                    |
|                | CBB1P12P18   | 1002044     | Comb Bus Bar         | 1                    | 12 pins | 18 mm <sup>2</sup> |                    |
|                | CBB1P18P18   | 1002045     | Comb Bus Bar         | 1                    | 18 pins | 18 mm <sup>2</sup> |                    |
|                | CBB1P57P18   | 1002046     | Comb Bus Bar         | 1                    | 57 pins | 18 mm <sup>2</sup> |                    |
|                | CBB1P06P25   | 1002047     | Comb Bus Bar         | 1                    | 6 pins  | 25 mm <sup>2</sup> |                    |
|                | CBB1P12P25   | 1002048     | Comb Bus Bar         | 1                    | 12 pins | 25 mm <sup>2</sup> |                    |
|                | CBB1P18P25   | 1002049     | Comb Bus Bar         | 1                    | 18 pins | 25 mm <sup>2</sup> |                    |
|                | CBB1P57P25   | 1002050     | Comb Bus Bar         | 1                    | 57 pins | 25 mm <sup>2</sup> |                    |
|                | CBB2P06P18   | 1002051     | Comb Bus Bar         | 2                    | 6 pins  | 18 mm <sup>2</sup> |                    |
|                | CBB2P12P18   | 1002052     | Comb Bus Bar         | 2                    | 12 pins | 18 mm <sup>2</sup> |                    |
|                | CBB2P18P18   | 1002053     | Comb Bus Bar         | 2                    | 18 pins | 18 mm <sup>2</sup> |                    |
|                | CBB2P56P18   | 1002054     | Comb Bus Bar         | 2                    | 56 pins | 18 mm <sup>2</sup> |                    |
|                | CBB2P06P25   | 1002055     | Comb Bus Bar         | 2                    | 6 pins  | 25 mm <sup>2</sup> |                    |
|                | CBB2P12P25   | 1002056     | Comb Bus Bar         | 2                    | 12 pins | 25 mm <sup>2</sup> |                    |
|                | CBB2P18P25   | 1002057     | Comb Bus Bar         | 2                    | 18 pins | 25 mm <sup>2</sup> |                    |
|                | CBB2P56P25   | 1002058     | Comb Bus Bar         | 2                    | 56 pins | 25 mm <sup>2</sup> |                    |
|                | CBB3P06P18   | 1002059     | Comb Bus Bar         | 3                    | 6 pins  | 18 mm <sup>2</sup> |                    |
|                | CBB3P12P18   | 1002060     | Comb Bus Bar         | 3                    | 12 pins | 18 mm <sup>2</sup> |                    |
|                | CBB3P18P18   | 1002061     | Comb Bus Bar         | 3                    | 18 pins | 18 mm <sup>2</sup> |                    |
|                | CBB3P57P18   | 1002062     | Comb Bus Bar         | 3                    | 57 pins | 18 mm <sup>2</sup> |                    |
|                | CBB3P06P25   | 1002063     | Comb Bus Bar         | 3                    | 6 pins  | 25 mm <sup>2</sup> |                    |
|                | CBB3P12P25   | 1002064     | Comb Bus Bar         | 3                    | 12 pins | 25 mm <sup>2</sup> |                    |
|                | CBB3P18P25   | 1002065     | Comb Bus Bar         | 3                    | 18 pins | 25 mm <sup>2</sup> |                    |
|                | CBB3P57P25   | 1002066     | Comb Bus Bar         | 3                    | 57 pins | 25 mm <sup>2</sup> |                    |
|                |              | FD50        | 1002067              | Bottom Feed Terminal | -       | -                  | 50 mm <sup>2</sup> |
|                |              | PC1077      | 1002068              | Protective Cap       | -       | -                  | -                  |
|                |              | TM802150S   | 1002071              | Top Feed Terminal    | 1       | -                  | 35 mm <sup>2</sup> |
|                |              | TM802153S   | 1002072              | Top Feed Terminal    | 1/2/3   | -                  | 35 mm <sup>2</sup> |
|                |              | TM802180    | 1002073              | Top Feed Terminal    | 2/3     | -                  | 35 mm <sup>2</sup> |
|                |              | EC10771     | 1002069              | End Cap              | 1       | -                  | -                  |
|                | EC10773      | 1002070     | End Cap              | 2/3                  | -       | -                  |                    |