

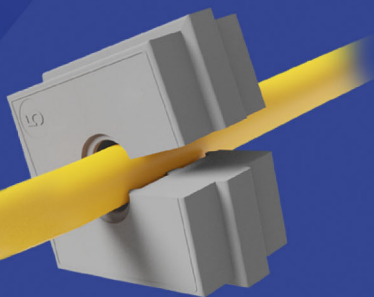

# ELECTRICAL COMPONENTS

## Cable Entry Systems

- Cable passing frames
- Split gland frames
- Split grommets
- Cable passing plates

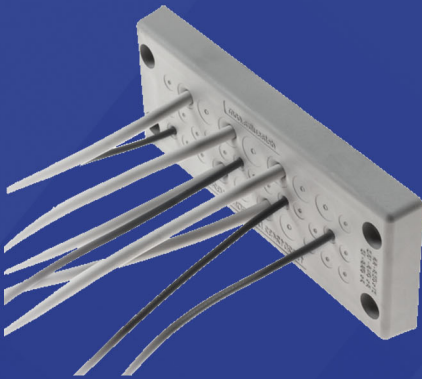

# Split Cable Glands

Split cable glands permit the passage of pre-terminated cables and wires while providing sealing and strain relief, in the transition from the exterior environment to a panel, enclosure, or machinery.

Split gland offered by ITC are composed of a thermoplastic frame which can be separated in 2 parts, and of grommets (inserts) made of elastomer resin, which can accommodate the cable or wire before being securely inserted in the frame.

All split cable frames are supplied with the corresponding locknut.

ITC offers the following models of split cable gland frames:

- **OSF:**
  - **Assembly:** Snap
  - **Sizes:** M16, M20, M25, M32
  - **Grommet Types:** SPC
  - **Ingress Protection:** IP54, NEMA12, IK10
  - **Frame Material:** Polycarbonate
  - **Operating Temperature:** -40 to 130°C
- **DESCCLICK:**
  - **Assembly:** Snap
  - **Sizes:** M20, M25, M32, M50
  - **Grommet Types:** SPP, SPG
  - **Ingress Protection:** IP54, NEMA12, IK10
  - **Frame Material:** Polycarbonate
  - **Operating Temperature:** -40 to 130°C
- **DESPRED**
  - **Assembly:** Screw
  - **Sizes:** M25, M32, M63
  - **Grommet Types:** SPP, SPG
  - **Ingress Protection:** IP66, NEMA4X, IK10
  - **Frame Material:** Polypropylene + fiberglass
  - **Operating Temperature:** -40 to 155°C



OSF

Split cable glands can use the following grommets (inserts):

- small size grommets with one hole (blind to 16mm diameter), 2 holes (2x 2 to 8mm), 4 holes (4x 2 to 6mm), 1 or 2 ASI slots
- large size grommets (blind to 34mm diameter). Grommets are supplied separately.

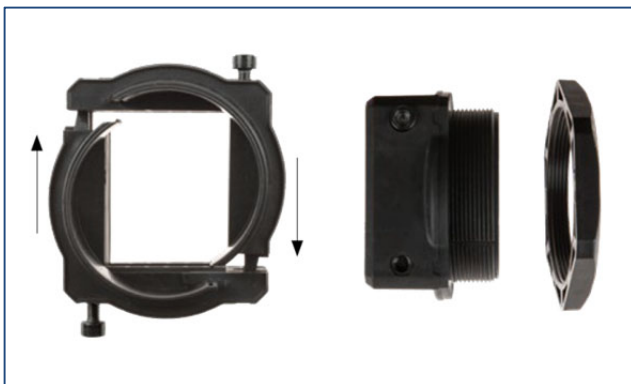

DESPRED

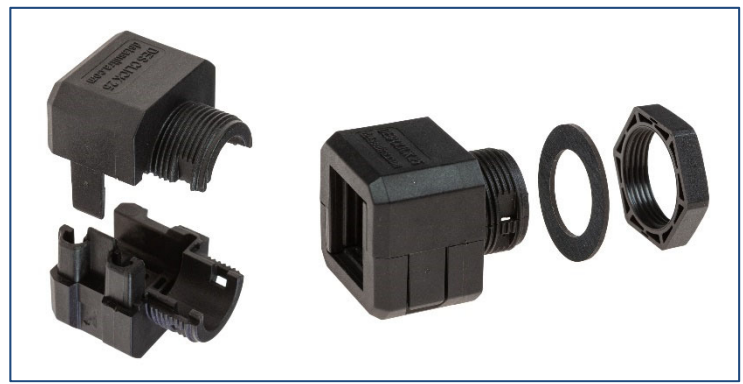





















DESCCLICK

## Split Cable Glands - Straight Frames - OSF, DESCLICK, DESPRED

OSF and Desclick are snap in model assemblies; Despred are screw assemblies.

### Split Cable Glands - Straight (Order by Part No.)

Thread	Part No.	Model	Approvals	Cutout (mm)	Grommet types	Colour	Pack
M16	154.016	OSF 16G		16.5	Small SPC	Grey	10
M20	154.020	OSF 20G		20.5	Small SPC	Grey	10
M25	154.025	OSF 25G		25.5	Small SPC	Grey	10
M32	154.032	OSF 32G		32.5	Small SPC	Grey	10
M16	154.116	OSF 16B		16.5	Small SPC	Black	10
M20	154.120	OSF 20B		20.5	Small SPC	Black	10
M25	154.125	OSF 25B		25.5	Small SPC	Black	10
M32	154.132	OSF 32B		32.5	Small SPC	Black	10
M40	154.140	OSF 40B		40.5	Small SPC	Black	10
M20	154.220	Desclick 20G		20.5	Small SPP	Grey	10
M25	154.225	Desclick 25G		22.5	Small SPP	Grey	10
M32	154.232	Desclick 32G		32.5	Small SPP	Grey	10
M50	154.251	Desclick 50G		50.5	Small SPP/large SPG	Grey	10
M20	154.320	Desclick 20B		20.5	Small SPP	Black	10
M25	154.325	Desclick 25B		22.5	Small SPP	Black	10
M32	154.332	Desclick 32B		32.5	Small SPP	Black	10
M50	154.351	Desclick 50B		50.5	Small SPP/large SPG	Black	10
M25	154.525	Despred 25		22.5	Small SPP	Black	10
M32	154.532	Despred 32		32.5	Small SPP	Black	10
M63	154.563	Despred 63		63.5	Small SPP/large SPG	Black	10

information subject to change without notice

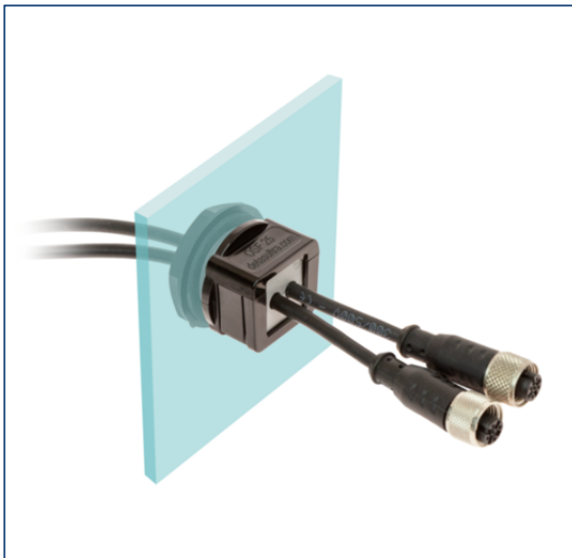

154.125 OSF 40G



154.251 Desclick 50G

## 90-Degrees Split Cable Gland Frames - OSF90, DESPRED 50-90

90-degrees 'Elbow' models of split glands, designed for use where space or access is limited.

### Features and Specifications:









#### Model DES OSF90

- **Sizes:** M16, M20, M25, M32
- **Ingress Protection:** IP54, NEMA12, IK10
- **Material:** Polycarbonate
- **Operating Temperature:** -40 to 130°C

#### Model DESPRED 50-90

- **Size:** M50
- **Ingress Protection:** IP54, IK10
- **Material:** Polyamide66 + fiberglass
- **Operating Temperature:** -40 to 155°C

### 90 degrees Split Cable Glands (order by Part No.)

Thread	Part No.	Model	Approvals	Cutout mm	Grommet types	Colour	Pack
M16	154.616G	OSF90 16G		16.5	Small SPC	Grey	10
M20	154.620G	OSF90 20G		20.5	Small SPC	Grey	10
M25	154.625G	OSF90 25G		25.5	Small SPC	Grey	10
M32	154.632G	OSF90 32G		32.5	Small SPC	Grey	10
M16	154.616B	OSF90 16B		16.5	Small SPC	Black	10
M20	154.620B	OSF90 20B		20.5	Small SPC	Black	10
M25	154.625B	OSF90 25B		25.5	Small SPC	Black	10
M32	154.632B	OSF90 32B		32.5	Small SPC	Black	10
M50	154.651B	Despred 50-90B		50.5	Small SPP/large SPG	Black	10

Information subject to change without notice

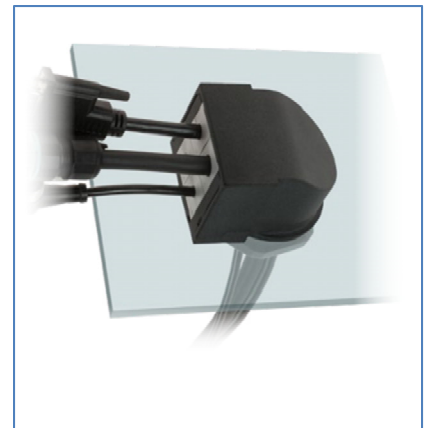
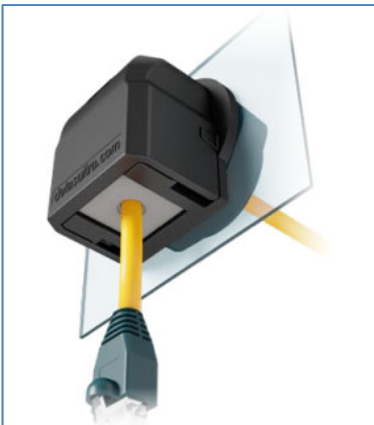

























## Grommets - Small - SPC

SPC grommets for use with OSF split cable glands.

### Features and Specifications:

- **Colour:** Grey, black available on request
- **Ingress Protection:** IP54
- **Material:** Thermoplastic Elastomer (TPE), UL94-V0
- **Operating Temperature:** -40 to 110°C

### SPC (SMALL) grommets for DES OSF split glands (Order by Part No.)

Cable size mm	Approvals	Part No. (Grey)	Pack Qty
Blind		DE-SPC 0G	10
2 - 3		DE-SPC 2G	10
3 - 4		DE-SPC 3G	10
4 - 5		DE-SPC 4G	10
5 - 6		DE-SPC 5G	10
6 - 7		DE-SPC 6G	10
7 - 8		DE-SPC 7G	10
8 - 9		DE-SPC 8G	10
9 - 10		DE-SPC 9G	10
10 - 11		DE-SPC 10G	10
11 - 12		DE-SPC 11G	10
12 - 13		DE-SPC 12G	10
13 - 14		DE-SPC 13G	10
14 - 15		DE-SPC 14G	10
2x2		DE-SPC 2x2G	10
2x3		DE-SPC 2x3G	10
2x4		DE-SPC 2x4G	10
2x5		DE-SPC 2x5G	10
2x6		DE-SPC 2x6G	10
2x7		DE-SPC 2x7G	10
4x2		DE-SPC 4x2G	10
4x3		DE-SPC 4x3G	10
4x4		DE-SPC 4x4G	10
4x5		DE-SPC 4x5G	10
4x6		DE-SPC 4x6G	10

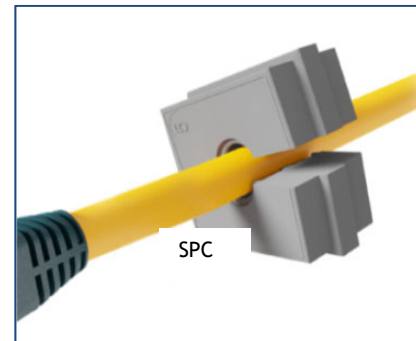
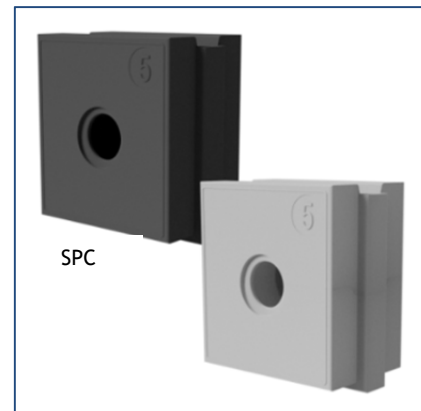

Information subject to change without notice

ATEX versions available upon request

Black grommets - special order, use the suffix B on part number instead of G

### SPC Grommets with Extended Range for Cables without Connectors (Order by Part No.)

Cable Size Max (mm)	Approvals	Part No. (Grey)	Part No. (Black)	Pack Qty
	 pending	DE-SPC K0G	DE-SPC K0B	10
8		DE-SPC K1G	DE-SPC K1B	10
11		DE-SPC K2G	DE-SPC K2B	10
13		DE-SPC K3G	DE-SPC K3B	10
14		DE-SPC K4G	DE-SPC K4B	10

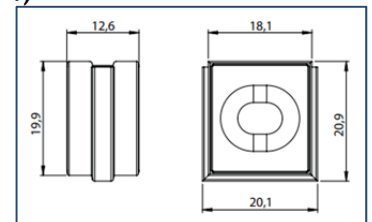

Information subject to change without notice

ATEX versions available upon request

































## Grommets - Small - SPP

SPP grommets for use with DESPRED and DESCLICK split cable entry systems.

### Features and Specifications:

- **Colour:** Grey, black available on request
- **Ingress Protection:** IP66
- **Material:** Thermoplastic Elastomer (TPE), UL94-V0
- **Operating Temperature:** -40 to 110°C

SPP (SMALL) grommets for DESPRED, DES CLICK, DES FRAME cable entry systems (Order by Part No.)

Cable Range mm	Approvals	Part No. (Grey)	Part No. (Black)	Pack Qty
Blind	 us	DE-SPP 0G	DE-SPP 0B	10
Blind / Pierceable 4x6	 us	DE-SPP M4G	DE-SPP M4B	10
Blind / Pierceable 2x4 + 2x8	 us	DE-SPP M4BG	DE-SPP M4BB	10
2 - 3	 us	DE-SPP 2G	DE-SPP 2B	10
3 - 4	 us	DE-SPP 3G	DE-SPP 3B	10
4 - 5	 us	DE-SPP 4G	DE-SPP 4B	10
5 - 6	 us	DE-SPP 5G	DE-SPP 5B	10
6 - 7	 us	DE-SPP 6G	DE-SPP 6B	10
7 - 8	 us	DE-SPP 7G	DE-SPP 7B	10
8 - 9	 us	DE-SPP 8G	DE-SPP 8B	10
9 - 10	 us	DE-SPP 9G	DE-SPP 9B	10
10 - 11	 us	DE-SPP 10G	DE-SPP 10B	10
11 - 12	 us	DE-SPP 11G	DE-SPP 11B	10
12 - 13	 us	DE-SPP 12G	DE-SPP 12B	10
13 - 14	 us	DE-SPP 13G	DE-SPP 13B	10
14 - 15	 us	DE-SPP 14G	DE-SPP 14B	10
15 - 16	 us	DE-SPP 15G	DE-SPP 15B	10
16 - 17	 us	DE-SPP 16G	DE-SPP 16B	10
2x2	 us	DE-SPP 2x2G	DE-SPP 2x2B	10
2x3	 us	DE-SPP 2x3G	DE-SPP 2x3B	10
2x4	 us	DE-SPP 2x4G	DE-SPP 2x4B	10
2x5	 us	DE-SPP 2x5G	DE-SPP 2x5B	10
2x6	 us	DE-SPP 2x6G	DE-SPP 2x6B	10
2x7	 us	DE-SPP 2x7G	DE-SPP 2x7B	10
2x8	 us	DE-SPP 2x8G	DE-SPP 2x8B	10
4x2	 us	DE-SPP 4x2G	DE-SPP 4x2B	10
4x3	 us	DE-SPP 4x3G	DE-SPP 4x3B	10
4x4	 us	DE-SPP 4x4G	DE-SPP 4x4B	10
4x5	 us	DE-SPP 4x5G	DE-SPP 4x5B	10
4x6	 us	DE-SPP 4x6G	DE-SPP 4x6B	10
1xASI	 us	DE-SPP ASI G	DE-SPP ASI B	10
2xASI	 us	DE-SPP ASI2 G	DE-SPP ASI2 B	10

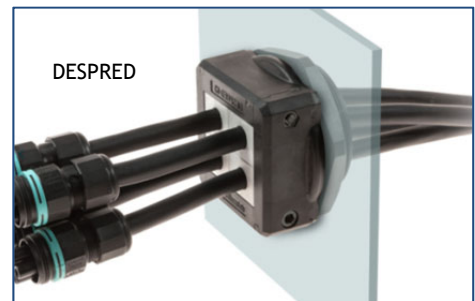

Information subject to change without notice; ATEX versions available upon request  
 Black grommets - special order, use the suffix B on part number instead of G





















## Grommets - Large - SPG

SPG grommets for use with DESPRED 63 , DESCLICK 50 split cable glands and DES FRAMES, available in grey (standard) and black (special order only).

### Features and Specifications:

- **Colour:** Grey, black available on request
- **Ingress Protection:** IP66
- **Material:** Thermoplastic Elastomer (TPE), UL94-V0
- **Operating Temperature:** -40 to 110°C

### SPG (LARGE) grommets for DESPRED 63, DESCLICK 50 split glands & DES FRAMES (Order by Part No.)





Cable size (mm)	Approvals	Part No. (Grey)	Part No. (Black)	Pack Qty
Blind		DE-SPG 0G	DE-SPG 0B	10
Blind / Pierceable ^		DE-SPG K0G	DE-SPG K0B	10
17		DE-SPG 17G	DE-SPG 17B	10
18		DE-SPG 18G	DE-SPG 18B	10
19		DE-SPG 19G	DE-SPG 19B	10
20		DE-SPG 20G	DE-SPG 20B	10
21		DE-SPG 21G	DE-SPG 21B	10
22		DE-SPG 22G	DE-SPG 22B	10
23		DE-SPG 23G	DE-SPG 23B	10
24		DE-SPG 24G	DE-SPG 24B	10
25		DE-SPG 25G	DE-SPG 25B	10
26		DE-SPG 26G	DE-SPG 26B	10
27		DE-SPG 27G	DE-SPG 27B	10
28		DE-SPG 28G	DE-SPG 28B	10
29		DE-SPG 29G	DE-SPG 29B	10
30		DE-SPG 30G	DE-SPG 30B	10
31		DE-SPG 31G	DE-SPG 31B	10
32		DE-SPG 32G	DE-SPG 32B	10
33		DE-SPG 33G	DE-SPG 33B	10
34		DE-SPG 34G	DE-SPG 34B	10

Information subject to change without notice  
ATEX versions available upon request

^ Blind grommet SPG K0G can be pierced through its membrane; 1 hole up to 32mm diameter.



### SPG M Large Grommets - Double Membrane - for cables without connectors (Order by Part No.)

# of Cables Size Max (mm)	Approvals	Part No. (Grey)	Part No. (Black)	Pack Qty
4 13.5mm 2 5mm 1 9.5mm		DE-SPG M7G	DE-SPG M7B	10
9 8.8mm		DE-SPG M9G	DE-SPG M9B	10
12 6.5mm 2 12mm		DE-SPG M14G	DE-SPG M14B	10
15 7mm		DE-SPG M15G	DE-SPG M15B	10

Information subject to change without notice  
ATEX versions available upon request



# DES Cable Passing Frames

The DetasUltra system includes various cable passing DES Frames so that you can combine multiple grommets into one frame.

## Features and specifications:

- **Colour:** Black
- **Assembly:** Allen screw (4mm Allen wrench)
- **Frame Material:** Polypropylene + fiberglass
- **Screws:** Stainless Steel
- **Operating Temperature:** -40 to 155°C
- **Protection:** IP66 (DES 24MX - IP54), NEMA12, IK10
- **Approvals:** cURus (DES24MX - cURus pending)

## Cable Passing Frames (Order by Part No.)

Part No.	Model	Approvals	Multipole connector size equivalent	Use With	Accommodates	Protection
154.724	DES 24		24	SPG SPP SPP 2x SPP 4x DES Flap DES Cover	From 10 SPP to 2 SPG + 2 SPP	IP66 NEMA12 IK10
154.724-90	DES 24 90		24		From 10 SPP to 2 SPG + 2 SPP	
154.716	DES 16		16		From 8 SPP to 2 SPG	
154.710	DES 10		10		From 6 SPP to 1 SPG + 2 SPP	
154.708	DES Q		—	4 SPP or 1 SPG		
154.702	DES L2		—	2 SPP		
154.703	DES L3		—	3 SPP		
154.704	DES L4		—	4 SPP		
154.705	DES L5		—	5 SPP		
154.752 154.753 154.754	DES 24MX2 DES 24MX3 DES 24MX4		—	24 x 2 24 x 3 24 x 4	SPG SPP SPP 2x SPP 4x	

*Information subject to change without notice  
For dimensions and cut-outs, See pages 9 to 11*

Cable passing frames include the assembly screws, and mounting screws can be ordered separately. Contact ITC for details.

### DES Flap

The DES FLAP solution is a quick installation solution for the DES 24, 16, 10 and Q frames. Quick modifications are possible. This solution also allows for a significant space reduction.

### DES Cover

Thanks to the DES COVER series the unused panels holes can be covered and protected from liquids and dust.





**DES 24**

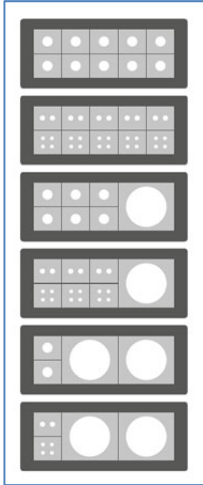

Sample configurations

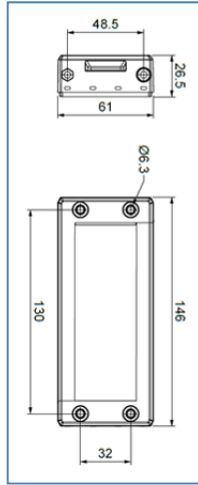

Dimensions

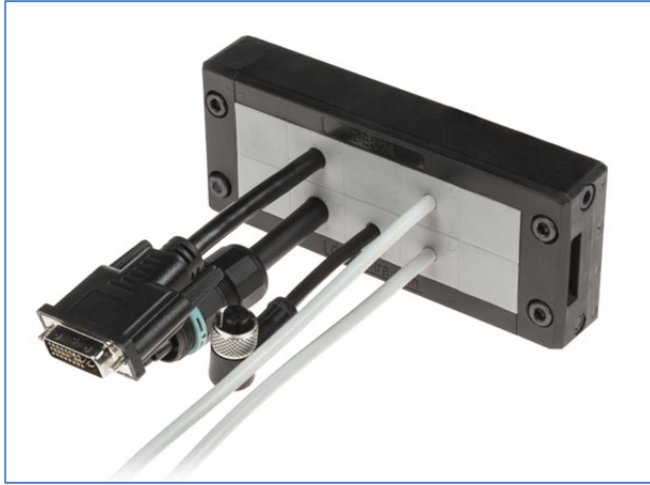

**DES 16**

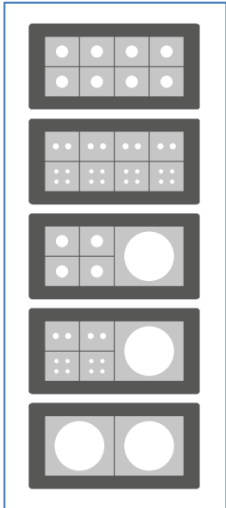

Sample configurations

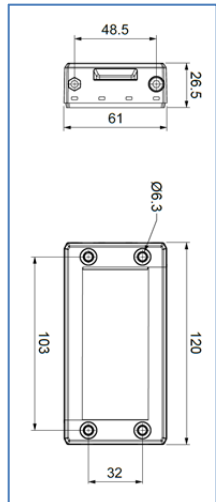

Dimensions



**DES 10**

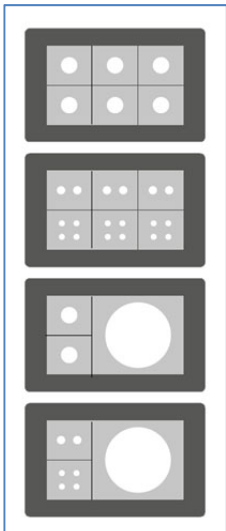

Sample configurations

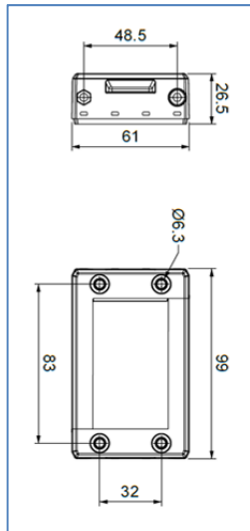

Dimensions



**DES Q**

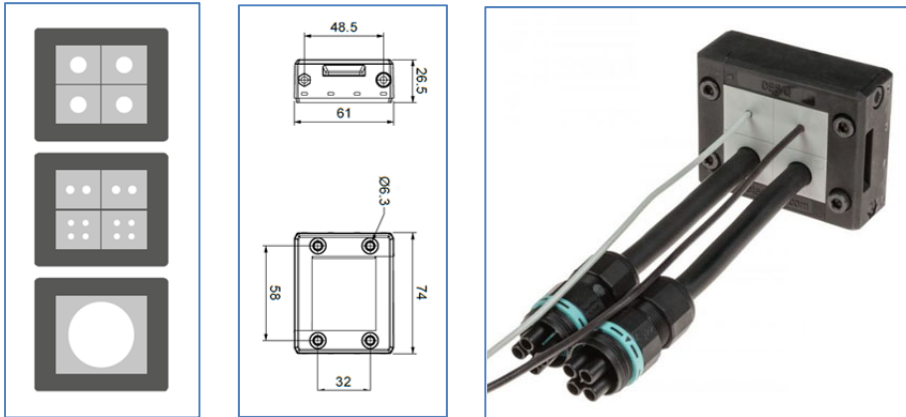

Sample configurations      Dimensions

**DES L2**

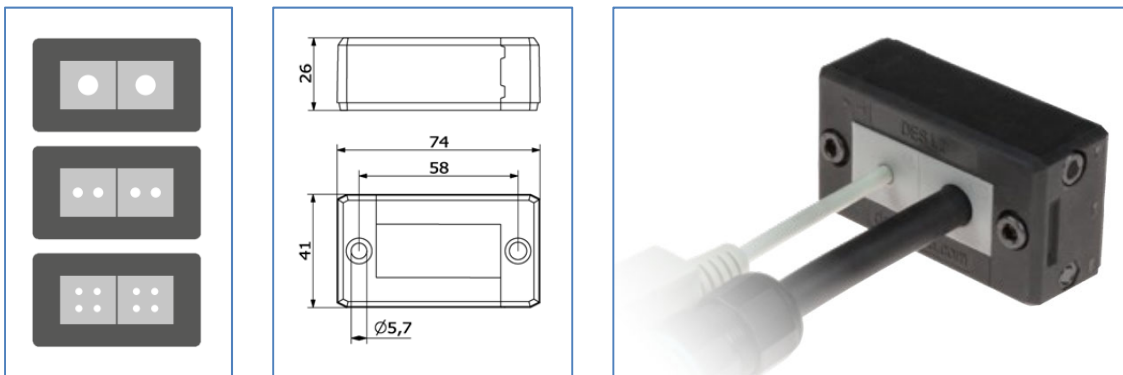

Sample configurations

Dimensions

**DES L3**

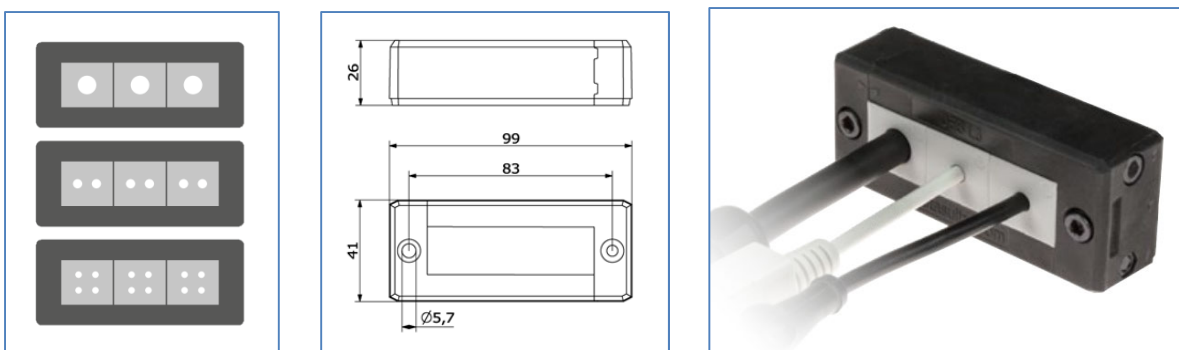

Sample configurations

Dimensions

**DES L4**

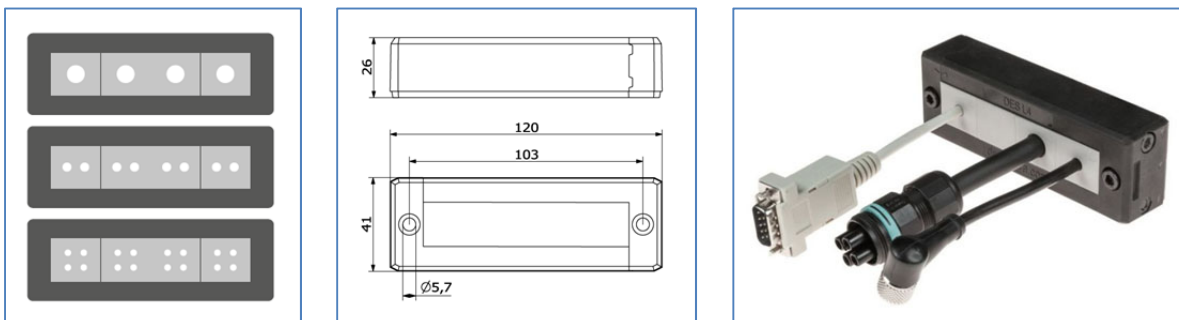

Sample configurations

Dimensions

**DES L5**

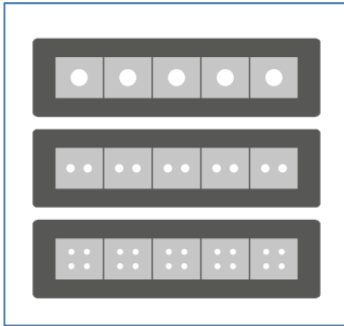

Sample configurations

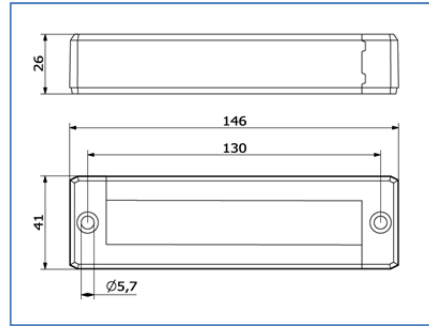

Dimensions

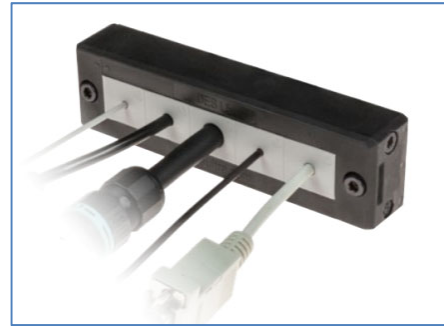

**DES 24MX**

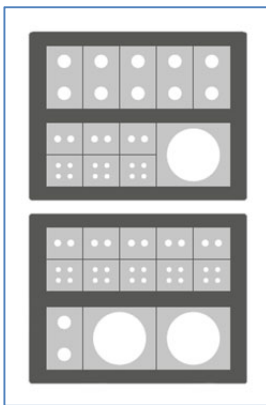

Sample DES 24MX2 configurations

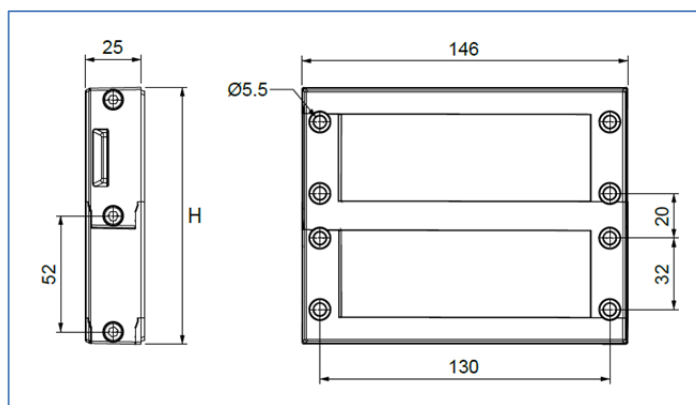

Dimensions

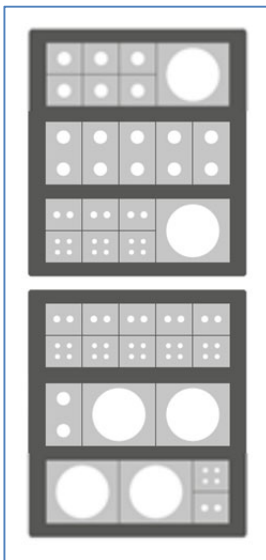

Sample DES 24MX3 configurations



**Punching Tools** - ITC carries a full line of punching tools required for use with the cable entry systems in this catalog. Please contact ITC for detailed information.



# ELECTRICAL COMPONENTS

416.663.7223  
[www.itcproducts.com](http://www.itcproducts.com)  
 50 Mural St Unit 8  
 Richmond Hill, ON L4B 1E4



DIN Rail



DIN Rail Accessories



Non-Metallic Enclosures



Hinged Enclosures



Thermal Management



PANEL Lighting



Multipole Connectors



Compact IP68 Connectors

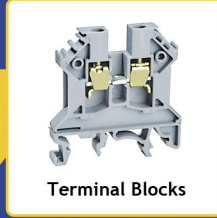

Terminal Blocks



Terminal Strips



22.5mm Pushbuttons



LED Indicators



Control Stations



Limit Switches



Micro Limit Switches



Safety Switches



Foot Switches

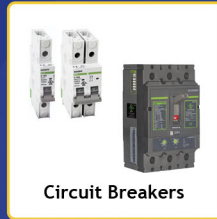

Circuit Breakers



IEC Contactors

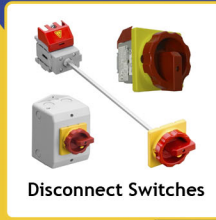

Disconnect Switches



Midget and CC Fuse Holders



Tower Lights



Power Continuity



Ferrules



Colour Coded Lugs



Crimp Terminals

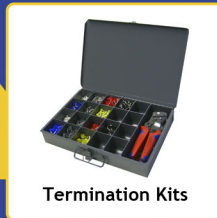

Termination Kits



Cable Glands



Thread Adapters



Cable Entry Systems



Wire Management



DIN Rail Cutters



Assembly Tables



Cutting & Stripping



Crimping Tools



Hole Cutting & Punching Tools

## SOME OF OUR MANUFACTURING PARTNERS

