

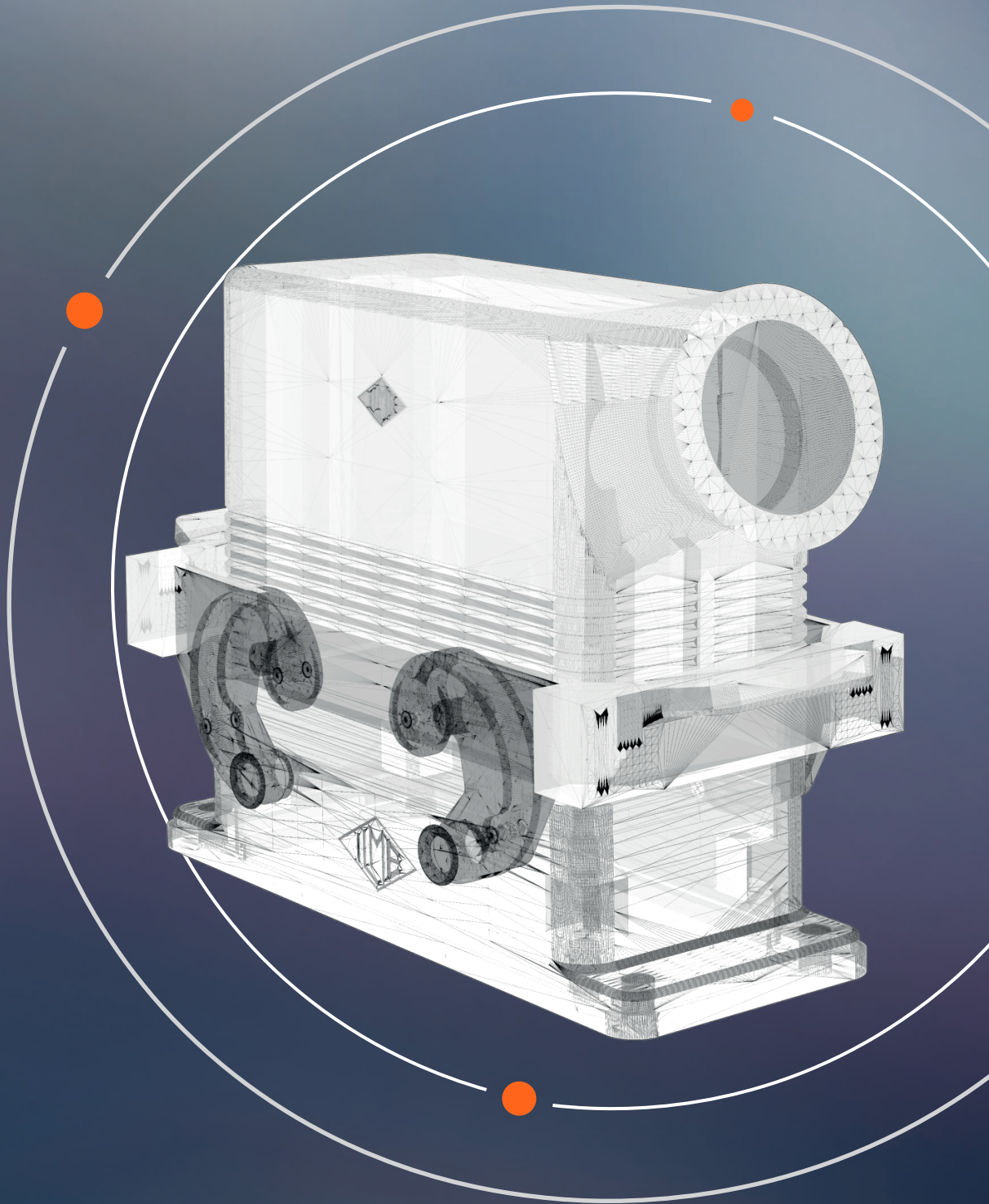

Multipole connectors for industrial purposes

# GENERAL CATALOGUE







Multipole connectors for industrial purposes

# **G E N E R A L**

---

# **C A T A L O G U E**

## **CN. 19**





## THE TRADITION OF INNOVATION SINCE 1945

ILME designs and manufactures complete solutions for industrial connections.

Headquartered in Milan and with subsidiaries in the key countries driving the progress of automation, ILME is an industry leader in the main world markets.

People are vital to success and growth at ILME, sharing a passion for innovation, utmost responsibility and participation.

The Company is committed to developing technology in the areas that most impact the future of the industries it serves: high quality and safe cabling, research on the most suitable materials, rapid turnaround and readily available services while striving for energy saving and environmental safeguard.

## COMMITMENT TO INDUSTRY

Technological innovation is the main pillar of ILME competitiveness.

In the electrical connection sector of industrial automation, characterized by the need for top performance and reliability, ILME is an acknowledged leader with its own patents and a global benchmark supplier of major companies worldwide.

ILME offers a fully integrated range of high-quality products and services for every type of connection to suit any application requirements.



AUTOMATION



RAILWAY



ENERGY



NAVAL



FOOD  
& BEVERAGE



AGRONOMY



OUTDOOR



TRANSPORT



LIGHT  
& SOUND



PLASTIC



CHEMICAL



AIRPORT



# Practical advices for consulting the catalogue

## Page layout and index

The ILME General Catalogue is divided into **five** sections to make it easier its consultation. All the products included have been grouped together by product lines.

The **sections** are marked with different colours to facilitate their immediate identification.

**Please refer to the example page at right.**

**1 Five sections** marked by different colours:

 **INTRODUCTION**

 **INSERTS**

 **ENCLOSURES**

 **ACCESSORIES AND TOOLS**

 **APPENDIX**

**2 Sub-sections** showing the specific product page.

**3 Chapters and technical detail page**

**4 Combinations and pictures**

List of the possible combinations between inserts and enclosures.

**5 Product descriptions and part numbers**

**6 Technical descriptions, 2D drawings**

**7 Load curves** (for more information please refer to page 28)

The **figurative index**, that opens each section, clearly shows the series of products relevant to each product line.

## Icons

Published in the “Combinations and pictures” area to to highlight specific points.



Important technical information



Key feature



Certifications and ratings



Availability of the products

## Notes

Dimensions shown are not binding and may be changed without notice.

All pictures shown are for illustration purpose only. Actual products may vary due to product enhancement.

# Example page

## Inserts

### CDD 72 poles + ⊕ 10A - 250V

enclosures: size "77.27"	page:
C-TYPE IP65/IP66	250 - 256
C7 IP67, two levers	276
V-TYPE IP65/IP66, single lever	282/292 - 295
BIG hoods	312 - 315
T-TYPE IP65 insulating	330 - 331
T-TYPE / W IP66 insulating	340 - 341
HYGIENIC T-TYPE / H IP66/IP69	354 - 355
HYGIENIC T-TYPE / C IP66/IP69, -50 °C	362 - 363
W-TYPE for aggressive environments	375
EMC	394
Central lever	408 - 409
IP68	428 - 431
LS-TYPE	454 - 455
E-Xtreme® corrosion proof	??? - ???
panel supports:	page:
COB	462 - 463

#### inserts, crimp connections

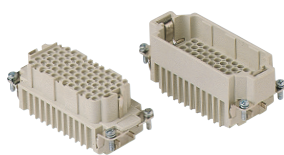

#### 10A crimp contacts silver and gold plated



PCBs interface, see article CIF 2.4 on page 447

description	part No.	part No.	part No.
without contacts (to be ordered separately)			
female inserts for female contacts	CDDF 72		
male inserts for male contacts	CDDM 72		
10A female contacts			
0,14-0,37 mm <sup>2</sup> AWG 26-22	identification No. 1	CDFA 0.3	CDFD 0.3
0,5 mm <sup>2</sup> AWG 20	identification No. 2	CDFA 0.5	CDFD 0.5
0,75 mm <sup>2</sup> AWG 18	identification No. ②	CDFA 0.7	CDFD 0.7
1 mm <sup>2</sup> AWG 18	identification No. 3	CDFA 1.0	CDFD 1.0
1,5 mm <sup>2</sup> AWG 16	identification No. 4	CDFA 1.5	CDFD 1.5
2,5 mm <sup>2</sup> AWG 14	identification No. 5	CDFA 2.5	CDFD 2.5
10A male contacts			
0,14-0,37 mm <sup>2</sup> AWG 26-22	identification No. 1	CDMA 0.3	CDMD 0.3
0,5 mm <sup>2</sup> AWG 20	identification No. 2	CDMA 0.5	CDMD 0.5
0,75 mm <sup>2</sup> AWG 18	identification No. ②	CDMA 0.7	CDMD 0.7
1 mm <sup>2</sup> AWG 18	identification No. 3	CDMA 1.0	CDMD 1.0
1,5 mm <sup>2</sup> AWG 16	identification No. 4	CDMA 1.5	CDMD 1.5
2,5 mm <sup>2</sup> AWG 14	identification No. 5	CDMA 2.5	CDMD 2.5

- characteristics according to EN 61984:

#### 10A 250V 4kV 2

- certified
- rated voltage according to UL/CSA: 600V
- insulation resistance: ≥ 10 GΩ
- ambient temperature limit: -40 °C ... +125 °C
- made of self-extinguishing thermoplastic resin UL 94V-0
- mechanical life: ≥ 500 cycles
- contact resistance: ≤ 3 mΩ
- for applications requiring higher voltages, please see the special voltage application section on page 66
- it is recommended to crimp the contacts with crimping tools homologated by ILME (please see the crimping tool section 10A contacts, CDF and CDM series on pages 531-539 and 544-549)
- for maximum current load refer to the following connector inserts derating diagrams; for more information see page 558

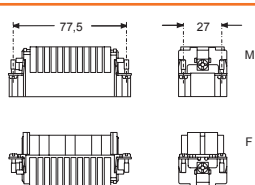

contacts side (front view)

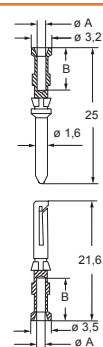
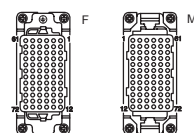

#### CDF and CDM contacts

conductor section mm <sup>2</sup>	conductor slot ø A (mm)	conductors stripping length B (mm)
0,14-0,37	0,9	8
0,5	1,1	8
0,75	1,3	8
1,0	1,45	8
1,5	1,8	8
2,5	2,2	6

CDD 72 poles connector inserts  
Maximum current load derating diagram

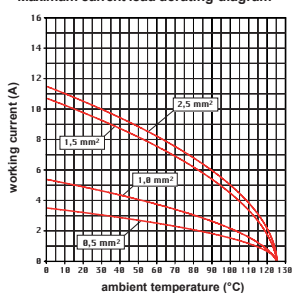

CR CP coding pin  
with loss of one contact  
(page 689)



‡ for basic or high thickness gold plating, please refer to page 480

dimensions shown in mm are not binding and may be changed without notice





## INTRODUCTION

IMPORTANT NOTES.....	8	• LOAD CURVES .....	28
CE MARKING .....	9	• TYPE OF ENCLOSURES .....	30
GENERAL FEATURES OF MULTIPOLE CONNECTORS ...	10	• APPLICATIONS SECTORS.....	33
• STANDARD INSERTS .....	12	• LOCKING SYSTEMS.....	34
• MIXO MODULAR UNITS .....	13	• TYPE OF COVERS .....	35
• INSERTS FEATURES.....	14	• TYPE OF HOODS / HOUSINGS.....	36
• MIXO INSERTS FEATURES .....	18	• ENCLOSURES FEATURES .....	42
• RECOMMENDED TIGHTENING TORQUE.....	20	• THE DEGREE OF PROTECTION.....	46
• RANGE OF CONDUCTOR CROSS-SECTIONAL AREA AND STRIPPING LENGHT .....	21	• CHANGEOVER FROM PG THREADS TO METRIC.....	47
• CONDUCTOR CONNECTION TECHNOLOGY .....	22	• COMBINATIONS BETWEEN ENCLOSURES AND INSERTS .....	48
• CRIMP CONTACTS OVERVIEW .....	27	• ACCESSORIES AND TOOLS FOR INSERTS AND ENCLOSURES .....	50

## INSERTS

52

• SCREW / SPRING / CRIMP CONNECTIONS UP TO 10A .....	58
• SQUICH® CONNECTION WITHOUT TOOLS 6A, 10A, 16A .....	63
• SCREW / SPRING / CRIMP CONNECTIONS UP TO 16A .....	98
• SCREW CONNECTIONS, CP - CP...RY SERIES UP TO 35A .....	178
• CRIMP CONNECTIONS, CQ SERIES 6,5A, 10A, 16A, 40A .....	182
• SCREW / CRIMP CONNECTIONS, CX SERIES 10A, 16A, 40A, 80A, 100A .....	194
• CRIMP CONNECTIONS, HNM SERIES 10A, 16A, 40A.....	208
• MIXO 4A, 10A, 16A, 40A, 70A, 100A, 200A.....	232
- DATA SERIES .....	256
- CRIMP CONNECTIONS, MIXO HNM SERIES 10A, 16A, 40A.....	290
• DATA CONNECTORS .....	304

## ENCLOSURES

334

• STANDARD APPLICATIONS: CK-CKA-MKA, CQ, IL-BRID, CZ7 RIGID LEVER, C-TYPE, T-TYPE, COB.....	339
• SPECIAL ENCLOSURES: MIXO ONE, BIG, EMC, 180 °C, HNM, CENTRAL LEVER .....	369
• WATERTIGHT:	
- IP67 (V-TYPE).....	436
- IP65/IP66 (V-TYPE) .....	444
- IP68 (CGK/MGK, CG/MG) .....	628
• AGGRESSIVE ENVIRONMENTS: T-TYPE/W, W-TYPE, E-Xtreme® .....	489
• FOR SPECIFIC APPLICATIONS:	
- HYGIENIC .....	501
- LS-TYPE .....	618

## ACCESSORIES AND TOOLS

660

• ACCESSORIES .....	664
• CRIMPING TOOLS .....	704

## APPENDIX

742

• INDEX PART NUMBERS.....	744
• DIMENSIONING OF CLEARANCES AND CREEPAGE DISTANCES.....	756
• EU ENVIRONMENTAL LEGISLATION.....	762
• FIRE PROTECTION STANDARDS FOR RAILWAY APPLICATIONS .....	763
• STANDARS AND CERTIFICATIONS .....	765
• SPECIFICATIONS .....	765



# IMPORTANT NOTES

Strictly tied to our general conditions of sales

- 1 ILME designs and manufactures complete solutions for Heavy Duty electrical power connections.  
The connector (although offered to the user as a variety of elements, usually inserts and enclosures, to allow the selection of the ideal combination) has been **designed as a complete connector** and tested to be compliant with the essential safety requirements of the EU Low Voltage Directive 2006/95/EC (2014/35/EU from April 20, 2016) and in particular the EN 61984 standard. The design of this “whole” system guarantees that every allowed combination of inserts, enclosures and accessories cannot result as improper.

---

- 2 The products in this catalogue alone cannot guarantee the best functionality upon installation, as this depends also on their correct **“putting into service”** which must be performed in compliance with the applicable system safety standards and according to the “rule of the art”. Therefore the effectiveness of the installation of the connector depends on the choices of the end user who must also take into account the following safety requirements.

---

- 3 Connectors must **not be connected or disconnected when live or under load**.

---

- 4 After wiring the inserts it is necessary **to verify the continuity of the protective earth connections**.

---

- 5 The **correct coupling of the inserts** is guaranteed only if they are installed (with the four fixing screws supplied\*) inside the corresponding enclosures or onto compatible accessories in this catalogue. ILME S.p.A. is not responsible for any different application.

---

- 6 Wiring of **screw-type terminal connections** must be carried out applying the correct tightening torque in order to avoid false contacts or damage to the conductor, the screw or the terminal.

---

- 7 **Crimping tools** and **crimp contacts** used should preferably be supplied by the same manufacturer to avoid difficulties with the insertion and retention or damaging of the contacts themselves.

---

- 8 Correct wiring of **spring-clamp connection inserts** is guaranteed only when the correct screwdriver indicated in the specific catalogue, or possibly on the insert, is used\*\*.

---

- 9 Avoid forcing the contacts during **connection and disconnection**. Connectors must be coupled and uncoupled in the axial direction with respect to the contacts, without bending and pulling the attached conductor bundles or cables.

---

- 10 Installation of two **inserts side by side**, in enclosures with two bays, must respect the polarity drawing marked on the insert (or the contact side view, as shown in this catalogue) to avoid inverted coupling.

---

- 11 Installation of two or more identical **connectors side by side** is recommended only with the use of **coding pins** in order to avoid mismatched couplings.

---

- 12 In order to keep the declared **degree of protection** (IP code according to EN 60529, or Enclosure Type Rating according to ANSI/UL 50E), enclosures must be completed with cable glands and/or other accessories with at least an equal degree of protection.

---

- 13 Moreover, the declared **degree of protection** (IP code according to EN 60529, or Enclosure Type Rating according to ANSI/UL 50E) is guaranteed when the enclosures, complete with inserts, are coupled and locked with their locking levers (or devices).

---

- 14 Connector inserts and their enclosures are generally compatible with similar/equivalent products from other manufacturers, according to the last samples tested. Full compatibility cannot be guaranteed in the event of technical changes made by other manufacturers. In particular, maximum performance of IP68 enclosures (CG Series) cannot be guaranteed when coupled with other manufacturers' products.

---

- 15 **Spare parts** are supplied in minimum quantities only with the purpose to replace damaged parts. To avoid invalidation of warranty, products should be modified or repaired only by ILME: the integrity of their functionality - e.g. their degree of protection - can no longer be guaranteed if products are modified/repared by end-users. In any case, the liability for correct choice, assembly and use is totally at charge of the installer and the end-user.

---

- 16 ILME S.p.A. takes no responsibility in verifying whether the components herein contained comply with any specific regulations of fields of application.

---

- 17 ILME cannot be held responsible for individual components in **uses other than those described in this catalogue**.  
ILME cannot be held responsible for **incorrect connector selection** in relation to the environmental conditions of the application (e.g.: influence of ambient temperature, moisture, environmental pollution, etc.).

\* Except one fixing screw for size “21.21” inserts, two fixing screws for size “32.13” inserts.

\*\* Except for **Squich**® inserts (with spring-clamp terminals with actuator button) that do not require any tool to operate the terminal.

# CE MARKING

As from 1<sup>st</sup> January 1997, in order to make available electrical products on the European market, the manufacturer must ensure that these bear the relevant **CE marking**, in line with the Low Voltage Directive 73/23/EEC\* (implemented in Italy as L. D. 18-10-1977 no. 791) and its modification 93/68/EEC\* (implemented in Italy as L.D. 25-11-1996 no. 626/96, published in the supplement to the Gazzetta Ufficiale of 14-12-1996).

The CE marking must be visible on the product or, if this is not possible, on the packaging, the instructions for use or on the warranty certificate. It acts as a declaration by the manufacturer that the product complies with all relevant EU directives regarding its field of application.

## **ILME products bear the CE marking on the actual product or its packaging.**

Almost all ILME products fall within the scope of the Low Voltage Directive. An EU declaration of conformity is required in order to be able to apply the CE marking. This declaration, to which the market is not directly entitled, must be made available to the controlling authorities (in Italy, the Ministry of Economic Development) at all times. In it, the manufacturer declares the technical safety standard(s) followed in the design and manufacture of the product. These standards must be, in decreasing order of preference:

- a European standard (EN prefix)
- a European harmonisation document (HD prefix)
- an international IEC standard
- a national standard
- in the absence of reference standards, the manufacturer's internal specifications guaranteeing compliance with the basic safety requirements of the directive.

Conformity with harmonised technical standards (i.e. ratified by CENELEC) also constitutes presumption of conformity with the basic safety requirements of the directives.

The CE marking of ILME products results from the declaration of conformity of the product to harmonised standards or international IEC standards.

Through the CE marking, ILME declares full compliance, not merely with the directive's basic safety requirements, but also with those international or national standards on which voluntary safety certification markings are based (e.g. IMQ and VDE). In this way, ILME intends to give the CE marking the value of self-certification in terms of safety, given the loss in legal value of voluntary certifications issued by third parties, ratified by directive 93/68/EEC\*.

Notwithstanding the above, practically all ILME products still bear voluntary conformity markings.

The above mentioned EU declaration of conformity becomes null and void when the assembly of products includes one or more components not manufactured by ILME and without CE marking.

**▲ The information contained in this catalogue is not binding and may be changed without notice.**

\* **Note:** The next legal reference for the Low Voltage Directive was 2006/95/EC, as consolidation of the original Directive 73/23/EEC + Directive 93/68/EEC. On 29<sup>th</sup> March 2014, the Official Journal of the European Union published the new Low Voltage directive 2014/35/EU dd. 26<sup>th</sup> February 2014, a recast version of directive 2006/95/EC, which is in force since 20<sup>th</sup> April 2016.



UNI EN ISO 9001: 2015  
Design, manufacture and distribution  
of industrial electrical equipment (IAF 19)  
Certificate No. 50 100 11133

# GENERAL FEATURES OF MULTIPOLE CONNECTORS

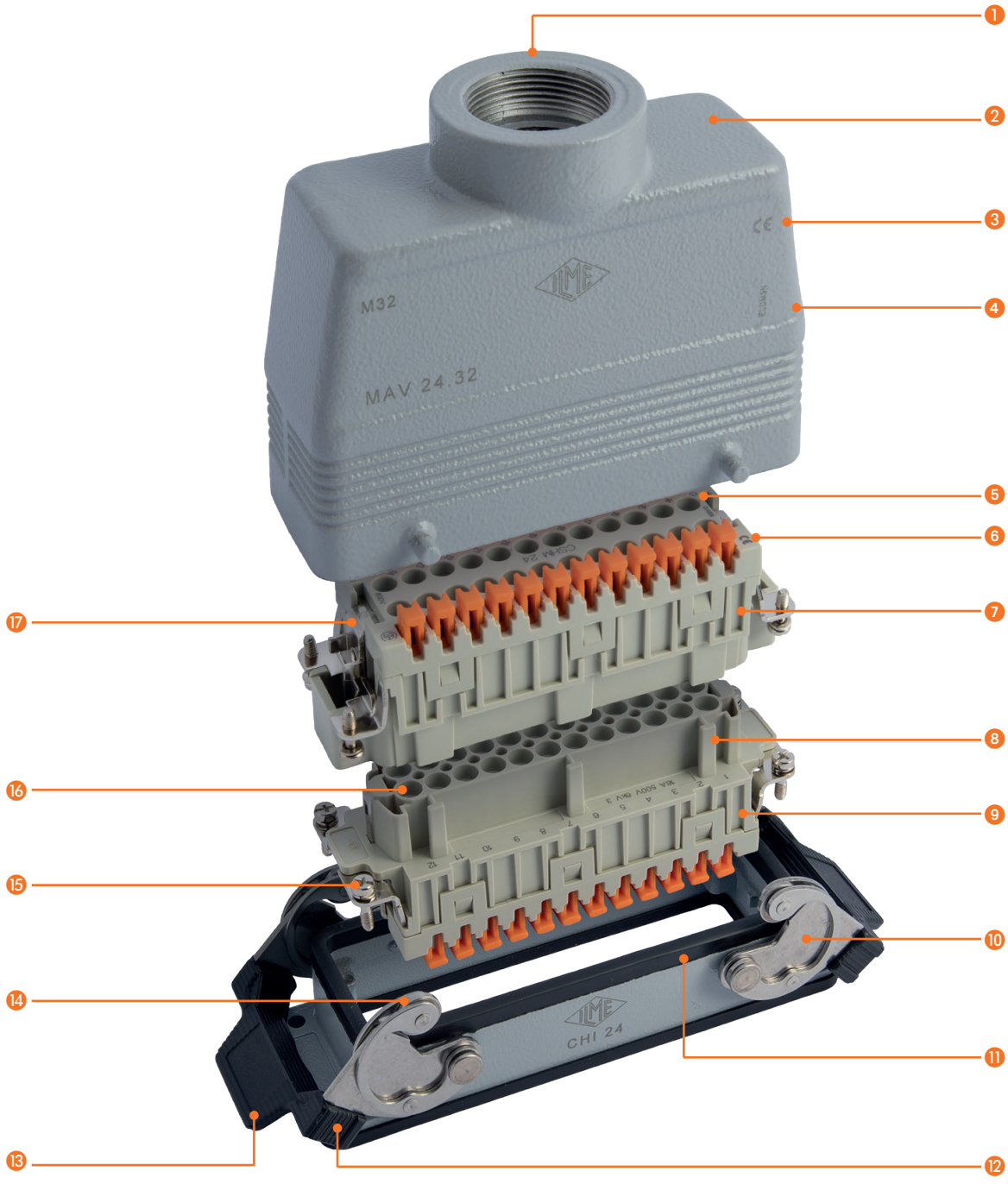

- 1 **Threaded cable entry** in various Pg diameters (types with pre-code "C") or metric cable entry (types with pre-code "M") in accordance with EN 60423, for cable entry devices in accordance with EN 62444 (NPT threading on request), may be located vertically, horizontally or frontally.
- 2 Rugged die-cast **aluminium alloy** or **zinc alloy** (most of CKA, MKA) or **self-extinguishing thermoplastic** enclosures (types CK, MK, CQ 08 and T-TYPE), cUL<sub>us</sub> approved.  
Surface-mounting, bulkhead, and hood versions available, with or without hinged cover, or with free protection covers. Enclosure types CH-CA (w/ Pg cable entries) and MH-MA (w/ metric cable entries) have an internal tab that prevents the insertion of higher voltage inserts series CME (all) and CMCE (only 16+2 poles), while CM (Pg) enclosures series and MM (metric) dedicated to those 830 V inserts have no tab and contain supplementary insulating strips inside.
- 3 **CE marking** attesting conformity to the requirements of the Low Voltage directive (2014/35/EU).
- 4 Metallic enclosures with a coated **finish** of thermosetting epoxy-polyester (epoxy for W-Type, IP68 CG/MG and E-Xtreme®) with high resistance to mechanical stress and external agents. Enclosures for use at temperatures up to 180 °C are treated with special coatings.  
Where improved electromagnetic shielding is necessary, EMC enclosures treated by highly conductive and corrosion resistant RoHS 2 conform surface treatment.
- 5 **Contact position** identified with numbers or codes on both sides of each insert and printed with a laser system or by mould.
- 6 **CE marking** attesting conformity to the requirements of the Low Voltage directive (2014/35/EU).
- 7 **Inserts** are made of UL certified self-extinguishing fibreglass reinforced thermoplastics, and feature an operating temperature range between -40 °C and +125 °C. The inserts CME (all) and CMCE (only 16+2 poles) for 830V have a key that prevents the insertion of inserts for use other than that prescribed (types CM - Pg and MM - metric). For some series, inserts in PPS (polyphenylene sulphide) may be requested for special uses with temperatures of up to 180 °C.
- 8 Insert **polarised profiles** with asymmetrical guides to avoid incorrect matings. Inserts have a mechanical life equal to or higher than 500 mating cycles.
- 9 Inserts and enclosures are manufactured in compliance with European standard **EN 61984** (DIN VDE 0627), certified and identified with **UL** (cUL<sub>us</sub> or UL) and **CSA** marks.
- 10 Stainless steel **locking levers and springs** guarantee a perfect closure and a tight sealing.
- 11 Special **sealing gaskets** in vinyl nitrile elastomer, polyurethane or fluoroelastomer (on R-Type enclosures for use with maximum temperatures of 180 °C, on W-Type enclosures for aggressive environments and on E-Xtreme® enclosures for ultimate resistance to corrosion and erosion), anti-aging, oil-resistant, fuel-resistant, together with the cable entry devices (not supplied) provide a degree of protection (IP code per EN IEC 60529 and Enclosure Type Rating per ANSI/UL 50E) for coupled connectors. Special conductive sealing gaskets for S-Type EMC enclosures.
- 12 **Locking device** available in two versions, simple (with one locking lever), or double (with two locking levers). In metallic enclosures, ILME offers different types of locking levers: vertical (V-Type) or classic (C-Type) rotational closure.
- 13 Various **handle** solutions are available: in self-extinguishing thermoplastic material; in die-cast aluminium, or by stainless steel (either integral or built-in with the lever).
- 14 **Pins and locking levers** (C-Type as shown in picture) supplied with anti-friction rolls that facilitate closure and limit wear and tear.
- 15 Captive **insert fastening screws**, with anti-slackening spring washer or under-head knurling.
- 16 **Silver or gold plated brass contacts** connected to the wires by means of captive screws supplied already slackened (screw-type connectors), with spring-clamp terminal (spring connectors), spring-clamp terminals already open with actuator button (Squich®, as shown in picture), by means of crimping (contacts available separately), or with a built-in 45° terminal block (in turn with screw-type or spring-clamp terminals).
- 17 Protective **earth terminal** with a wide contact surface.



Find more information on our products at [www.ilme.com](http://www.ilme.com)

## STANDARD INSERTS

Inserts are made of UL 94V-0 self-extinguishing thermoplastic resin, normally for use with a maximum ambient temperature of 125 °C; special versions made of >PPS< for use with a maximum ambient temperature of 180 °C. Screw, crimp or spring connections are available. Contacts are in silver or gold plated brass. Inserts are numbered on both sides by laser marking or moulded.

The large number of inserts versions is selected on the basis of rated voltage (50V - 5000V), rated current (5A - 200A max), number of poles and different load combinations required (power and signal poles within the same insert). Inserts are approved in accordance with the applicable safety standards by several third party agencies like UL, CSA, DNV-GL, Bureau Veritas, CQC and EAC. For certifications refer to the summary statement in this catalogue.

### SCREW

CNE

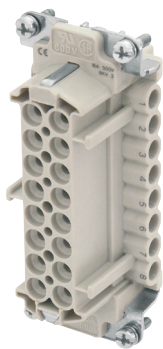

### CRIMP

CD - CDD

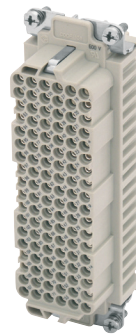



---

### SQUICH® - SPRING

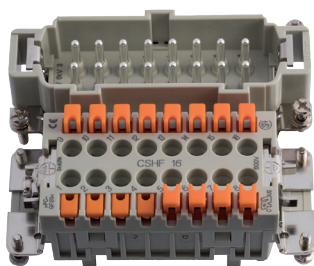
CSH

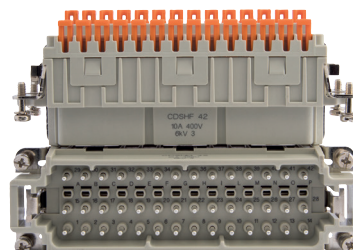

CDSH





## MIXO MODULAR UNITS

The MIXO series is a system composed of modular connector inserts and ancillary parts, able to create a wide diversity of tailored connector solutions, and to satisfy the most specific application needs using the traditional rectangular heavy-duty connector enclosures.

Inside a single enclosure it is possible to house various connections of different nature, for example lines for electrical signals (analogue or high-speed digital), electric power lines, quick coupling contacts for conducting compressed air with pressures of up to 8 bar, fibre optic contacts, Ethernet, USB and coaxial networks.

Insert compartments are composed by placing multiple MIXO modules side by side by locking them each other through specific dovetail shaped keys and keyways, to form a single compact block, much easier to handle and fix to the frame than individual "floating" modules; this block is then inserted in a suitably sized MIXO metal frame with predetermined locking slots. Once the single block of modules has been inserted in the frame and locked with the two special locking keys accompanying each MIXO frame, the connector composed in this manner can be inserted and fixed into the chosen enclosure.

### CRIMP, SPRING, SCREW

MIXO 4A - 5A  
10A - 16A - 40A

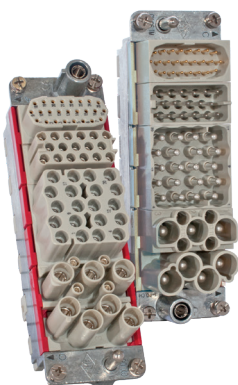

### CRIMP

MIXO 70A  
100A - 200A

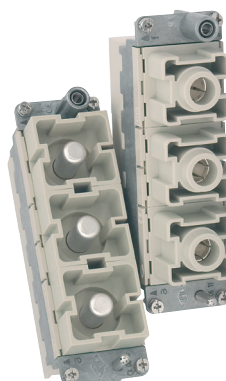

### CRIMP

MIXO BUS



MIXO POF/MOST®



MIXO COAX, HV, RJ45  
D-SUB, USB, PNEUMATIC

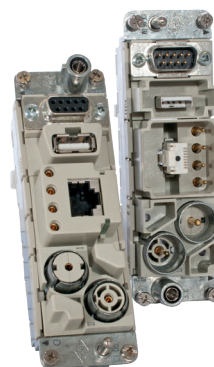

# INSERTS FEATURES

Inserts	No. of poles <sup>1)</sup>	Aux. contacts	Rated current <sup>2)</sup>	EN 61984 (2009-06) pollution degree 3			EN 61984 (2009-06) pollution degree 2			UL/CSA certification
				Rated voltage	Rated impulse voltage	Pollution degree	Rated voltage	Rated impulse voltage	Pollution degree	
Series	Main contacts + PE									
CK	3, 4	---	10A	230/400V	4kV	3	400/690V	4kV	2	600V
CKS ▲	3, 4	---	10A	400V	4kV	3	690V	4kV	2	600V
CKSH	3, 4	---	10A	400V	4kV	3				600V
CD	8 (without PE)	---	10A	50V	0,8kV	3				50V
CD *)	7, 15, 25, (50), 40, (80), 64, (128)	---	10A	250V **)	4kV	3	230/400V **)	4kV	2	600V
RD (HNM)	40, 64	---	10A	250V	4kV	3	230/400V	4kV	2	600V
CT	40, 64	---	10A	250V	4kV	3	230/400V	4kV	2	600V
CTS	40, 64	---	10A	250V	4kV	3	230/400V	4kV	2	600V
CDD	24, 38, (76), 42, 72, (144), 108, (216)	---	10A				250V	4kV	2	600V
RDD (HNM)	24, 42, 72, 108	---	10A				250V	4kV	2	600V
CDS ▲	9, 18, 27, (54), 42, (84)	---	16A	400V	6kV	3	400/690V	6kV	2	600V
CDSH	9, 18, 27, (54), 42, (84)	---	16A	400V	6kV	3	400/690V	6kV	2	600V
CDSH NC	6 (AutoShort NC 6A)	---	6A	250V	4kV	3	500V	4kV	2	600V
CDA	10, 16, (32)	---	16A	250V	4kV	3	230/400V	4kV	2	600V
CDC	10, 16, (32)	---	16A	250V	4kV	3	230/400V	4kV	2	600V
CSAH	10, 16, (32)	---	16A	250V	4kV	3	400V	4kV	2	600V
CQE	10, 18, (20), 32, 46, (64), (92)	---	16A	500V **)	6kV	3	830V **)	8kV	2	600V
CQEE	40, 64	---	16A	500V	6kV	3				600V
RQEE (HNM)	40, 64	---	16A	500V	6kV	3				600V
CCE	6, 10, (12), 16, 24, (32), (48)	---	16A	500V	6kV	3	400/690V	6kV	2	600V
RCE (HNM)	6, 10, 16, 24	---	16A	500V	6kV	3	400/690V	6kV	2	600V
CNE	6, (12), 10, 16, (32), 24, (48)	---	16A	500V	6kV	3	400/690V	6kV	2	600V
CSE ▲	6, (12), 10, 16, (32), 24, (48)	---	16A	500V	6kV	3	400/690V	6kV	2	600V
CSH	6, (12), 10, 16, (32), 24, (48)	---	16A	500V	6kV	3	400/690V	6kV	2	600V
CSH ... S	6, (12), 10, 16, (32), 24, (48)	---	16A	500V	6kV	3	400/690V	6kV	2	600V
CSS	6, (12), 10, 16, (32), 24, (48)	---	16A	500V	6kV	3	400/690V	6kV	2	600V
CT	6, (12), 10, 16, 24	---	16A				400V	4kV	2	600V
CTSE	6, (12), 10, 16, 24	---	16A	500V	6kV	3	400/690	6kV	2	600V
CME ▲ ●	3, 6, 10, (12), (20), (32)		16A	830V	8kV	3	1000V	8kV	2	600V
							720/1250V	8kV	2	
	16			400/690V	6kV	3				
CMSE ▲	3, 6, (12), 10, (20)		16A	830V	8kV	3	1000V	8kV	2	600V
							720/1250V	8kV	2	
CMSE ▲		2, (4)		500V	6kV	3				
CMSE ▲	3, 6, (12), 10, (20)		16A	830V	8kV	3	1000V	8kV	2	600V
							720/1250V	8kV	2	
CMSE ▲		2, (4)		500V	6kV	3				
CMCE	3, 6, (12), 10, (20)		16A	830V	8kV	3	1000V	8kV	2	600V
							720/1250V	8kV	2	
	16 ▲, (32) ▲			400/690V	6kV	3				
CMCE		2, (4)		500V	6kV	3				

▲ Available upon request

● CME series requires the CM-MM enclosures with additional insulation (available upon request) or T-TYPE insulated enclosures

Inserts	Certifications <sup>3)</sup>	Contact resistance	Insulation resistance	Ambient temperature limit (°C) <sup>4)</sup>		Degree of protection without enclosures	Conductor connection technology					From page	
							Axial screw	Screw	Spring	Squich®	45° terminal block		Crimp
CK	UL, CSA, CQC, DNV-GL, BV, EAC	≤ 2 mΩ	≥ 10 GΩ	-40	+100	IP20							58
CKS ▲	UL, CSA, CQC, DNV-GL, BV, EAC	≤ 3 mΩ	≥ 10 GΩ	-40	+125	IP20			•				-
CKSH	(UL), (CSA), (CQC), DNV-GL, BV, EAC	≤ 3 mΩ	≥ 10 GΩ	-40	+125	IP20				•			63
CD	UL, CSA, CQC, DNV-GL, BV, EAC	≤ 3 mΩ	≥ 10 GΩ	-40	+125	IP20						•	67
CD *)	UL, CSA, CQC, DNV-GL, BV, EAC	≤ 3 mΩ	≥ 10 GΩ	-40	+125	IP20						•	66
RD (HNM)	(UL), (CSA), (CQC), DNV-GL, BV, EAC	≤ 3 mΩ	≥ 10 GΩ	-40	+125	IP20						•	208
CT	UL, CSA, CQC, DNV-GL, BV, EAC	≤ 4 mΩ	≥ 10 GΩ	-40	+125	IP20		•				•	156
CTS	UL, CSA, CQC, DNV-GL, BV, EAC	≤ 4 mΩ	≥ 10 GΩ	-40	+125	IP20			•		•		156
CDD	UL, CSA, CQC, DNV-GL, BV, EAC	≤ 3 mΩ	≥ 10 GΩ	-40	+125	IP20						•	76
RDD (HNM)	(UL), (CSA), (CQC), DNV-GL, BV, EAC	≤ 3 mΩ	≥ 10 GΩ	-40	+125	IP20						•	210
CDS ▲	UL, CSA, CQC, DNV-GL, BV, EAC	≤ 3 mΩ	≥ 10 GΩ	-40	+125	IP20			•				-
CDSH	UL, (CSA), (CQC), DNV-GL, BV, EAC	≤ 3 mΩ	≥ 10 GΩ	-40	+125	IP20				•			86
CDSH NC	UL, (CSA), (CQC), DNV-GL, BV, EAC	≤ 3 mΩ	≥ 10 GΩ	-40	+125	IP20				•			95
CDA	UL, CSA, CQC, DNV-GL, BV, EAC	≤ 1 mΩ	≥ 10 GΩ	-40	+125	IP20		•					98
CDC	UL, CSA, CQC, DNV-GL, BV, EAC	≤ 1 mΩ	≥ 10 GΩ	-40	+125	IP20						•	104
CSAH	UL, CSA, (CQC), DNV-GL, BV, EAC	≤ 1 mΩ	≥ 10 GΩ	-40	+125	IP20				•			99
CQE	UL, CSA, CQC, DNV-GL, BV, EAC	≤ 1 mΩ	≥ 10 GΩ	-40	+125	IP20						•	168
CQEE	UL, CSA, CQC, DNV-GL, BV, EAC	≤ 1 mΩ	≥ 10 GΩ	-40	+125	IP20						•	176
RQEE (HNM)	(UL), (CSA), (CQC), DNV-GL, BV, EAC	≤ 1 mΩ	≥ 10 GΩ	-40	+125	IP20						•	218
CCE	UL, CSA, CQC, DNV-GL, BV, EAC	≤ 1 mΩ	≥ 10 GΩ	-40	+125	IP20						•	130
RCE (HNM)	(UL), (CSA), (CQC), DNV-GL, BV, EAC	≤ 1 mΩ	≥ 10 GΩ	-40	+125	IP20						•	214
CNE	UL, CSA, CQC, DNV-GL, BV, EAC	≤ 1 mΩ	≥ 10 GΩ	-40	+125	IP20		•					110
CSE ▲	UL, CSA, CQC, DNV-GL, BV, EAC	≤ 3 mΩ	≥ 10 GΩ	-40	+125	IP20			•				-
CSH	UL, CSA, CQC, DNV-GL, BV, EAC	≤ 3 mΩ	≥ 10 GΩ	-40	+125	IP20				•			110
CSH ... S	(UL), (CSA), (CQC), (DNV-GL), (BV), (EAC)	≤ 3 mΩ	≥ 10 GΩ	-40	+125	IP20				•			122
CSS	UL, CSA, CQC, DNV-GL, BV, EAC	≤ 3 mΩ	≥ 10 GΩ	-40	+125	IP20			•				148
CT	UL, CSA, CQC, DNV-GL, BV, EAC	≤ 4 mΩ	≥ 10 GΩ	-40	+125	IP20		•			•		160
CTSE	UL, CSA, CQC, DNV-GL, BV, EAC	≤ 4 mΩ	≥ 10 GΩ	-40	+125	IP20			•		•		160
CME ▲ ●	UL, CSA, CQC, DNV-GL, BV, EAC	≤ 1 mΩ	≥ 10 GΩ	-40	+125	IP20		•					-
CMSE ▲	UL, CSA, CQC, DNV-GL, BV, EAC	≤ 3 mΩ	≥ 10 GΩ	-40	+125	IP20			•				-
CMSH	UL, (CSA), (CQC), DNV-GL, BV, EAC	≤ 3 mΩ	≥ 10 GΩ	-40	+125	IP20				•			136
CMCE	UL, CSA, CQC, DNV-GL, BV, EAC	≤ 1 mΩ	≥ 10 GΩ	-40	+125	IP20						•	137

1) Polarities shown in brackets may be achieved by using two inserts.

2) Please check the insert load curves to establish the actual maximum operating current according to the ambient temperature.

3) The certifications shown in brackets are being applied for.

4) It may be used with ambient temperatures up to 180 °C by using the insert special version made of PPS (polyphenylene sulfide).

\*) CD 07: IP67 with thermoplastic enclosures (cannot be used with metal enclosures).

\*\*) Contacts partially fitted inside an insert allow inserts to be used for applications requiring rated voltages higher than those shown. See CD, CDD, CQE inserts relevant tables.



## INSERTS FEATURES

Inserts	No. of poles <sup>1)</sup>	Aux. contacts	Rated current <sup>2)</sup>	EN 61984 (2009-06) pollution degree 3			EN 61984 (2009-06) pollution degree 2			UL/CSA certification
				Rated voltage	Rated impulse voltage	Pollution degree	Rated voltage	Rated impulse voltage	Pollution degree	Rated voltage AC or DC
CP	6, (12)	---	35A	400/690V	6kV	3				600V
CQ 21	21 (without PE)	---	6,5A	50V <sub>AC</sub> /120V <sub>DC</sub>	0,8kV	3				50V <sub>AC</sub> /120V <sub>DC</sub>
CQ 07	7	---	10A	400V	6kV	3	400/690V	6kV	2	600V
CQ 12	12	---	10A	400V	6kV	3	400/690V	6kV	2	600V
CQ 05	5	---	16A	230/400V	4kV	3	320/500V	4kV	2	600V
CQ4 02	2	---	40A	400V	6kV	3				600V
CQ4 02 H	2	---	40A	830V	6kV	3				600V
CQ4 03	3	---	40A	400V	6kV	3				600V
CQ 17	17	---	10A	160V	2,5kV	3	250V	4kV	2	250V
CQ 08	8	---	16A	500V	6kV	3	400/690V	6kV	2	600V
CQ 04/2	4+PE		40A	400/690V	6kV	3				600V
		2	10A	250V	4kV	3				
CX 8/24	8		16A	230/400V	4kV	3	400V	4kV	2	600V
		24	10A	160V	2,5kV	3	250V	4kV	2	
CX 6/12	6+PE		40A	690V	8kV	3				600V
		12	10A	230/400V	6kV	3				
CX 6/36	6		40A	690V	8kV	3				600V
		36	10A	160V	2,5kV	3	250V	4kV	2	
CX 12/2	12		40A	690V	8kV	3				600V
		2	10A	250V	4kV	3				
RX 12/2 (HNM)	12		40A	690V	8kV	3				600V
		2	10A	250V	4kV	3				
CX 6/6	6+PE		100A	690V	8kV	3				600V
		6	16A	400V	6kV	3				
CX 4/0	4	0	80A	690V	8kV	3	830V			600V
CX 4/2	4		80A	690V	8kV	3	830V			600V
		2	16A	400V	6kV	3	400/690V	6kV	2	
CX 4/8	4		80A	400V	6kV	3	400/690V	6kV	2	600V
		8	16A	230/400V	4kV	3	400V	4kV	2	
CXL 2/4	2									600V
		4	10A	25V	0,8kV	3				
CLK 04	4 (seats/poles)	---	---	Contacts for glass fibre 50 / 125 µm or 62,5 / 125 µm or for 1 mm Ø POF						
CX 1/2 BD	1 CX 01 B /BC, CX 04 B, CX 08 B (*)		16/10/4A	50V	0,8kV	3				50V
		2	10A	50V	0,8kV	3				50V

<sup>1)</sup> Polarities shown in brackets may be achieved by using two inserts.

<sup>2)</sup> Please check the insert load curves to establish the actual maximum operating current according to the ambient temperature.

<sup>3)</sup> The certifications shown in brackets are being applied for.

<sup>4)</sup> It may be used with ambient temperatures up to 180 °C by using the insert special version made of PPS (polyphenylene sulfide).

(\*) Multi-axial shielded connectors CX 04 B (4P, 10A) or CX 08 B (8P, 5A) or coaxial connectors CX 01 B (10A) or CX 01 BC (16A).

Inserts	Certifications <sup>3)</sup>	Contact resistance	Insulation resistance	Ambient temperature limit (°C) <sup>4)</sup>		Degree of protection without enclosures	Conductor connection technology					From page	
							Axial screw	Screw	Spring	Squich®	45° terminal block		Crimp
CP	UL, CSA, CQC, DNV-GL, BV, EAC	≤ 0,5 mΩ	≥10 GΩ	-40	+125	IP20		•					178
CQ 21	(UL), (CSA), DNV-GL, BV	≤ 4 mΩ	≥10 GΩ	-40	+125	IP20						•	190
CQ 07	(UL), (CSA), (CQC), DNV-GL, BV, EAC	≤ 3 mΩ	≥10 GΩ	-40	+125	IP20						•	187
CQ 12	UL, CSA, CQC, DNV-GL, BV, EAC	≤ 3 mΩ	≥10 GΩ	-40	+125	IP20						•	189
CQ 05	UL, CSA, CQC, DNV-GL, BV, EAC	≤ 1 mΩ	≥10 GΩ	-40	+125	IP20						•	186
CQ4 02	(UL), (CSA), (CQC), (DNV-GL), (BV), (EAC)	≤ 0,3 mΩ	≥10 GΩ	-40	+125	IP20						•	182
CQ4 02 H	(UL), (CSA), (CQC), (DNV-GL), (BV), (EAC)	≤ 0,3 mΩ	≥10 GΩ	-40	+125	IP20						•	183
CQ4 03	UL, (CSA), (CQC), DNV-GL, BV, EAC	≤ 0,3 mΩ	≥10 GΩ	-40	+125	IP20						•	184
CQ 17	(UL), (CSA), (CQC), DNV-GL, BV, EAC	≤ 3 mΩ	≥10 GΩ	-40	+125	IP20						•	193
CQ 08	UL, CSA, CQC, DNV-GL, BV, EAC	≤ 1 mΩ	≥10 GΩ	-40	+125	IP20						•	192
CQ 04/2	UL, CSA, CQC, DNV-GL, BV, EAC	≤ 0,3 mΩ	≥10 GΩ	-40	+125	IP20						•	191
		≤ 3 mΩ										•	
CX 8/24	UL, CSA, CQC, DNV-GL, BV, EAC	≤ 1 mΩ	≥10 GΩ	-40	+125	IP20						•	194
		≤ 3 mΩ										•	
CX 6/12	UL, (CSA), (CQC), DNV-GL, BV, EAC	≤ 0,3 mΩ	≥10 GΩ	-40	+125	IP20						•	197
		≤ 1 mΩ											
CX 6/36	UL, CSA, CQC, DNV-GL, BV, EAC	≤ 0,3 mΩ	≥10 GΩ	-40	+125	IP20						•	198
		≤ 3 mΩ											
CX 12/2	UL, CSA, CQC, DNV-GL, BV, EAC	≤ 0,3 mΩ	≥10 GΩ	-40	+125	IP20						•	199
		≤ 3 mΩ											
RX 12/2 (HNM)	(UL), (CSA), (CQC), (DNV-GL), (BV), (EAC)	≤ 0,3 mΩ	≥10 GΩ	-40	+125	IP20						•	221
		≤ 3 mΩ											
CX 6/6	UL, CSA, CQC, DNV-GL, BV, EAC	≤ 0,3 mΩ	≥10 GΩ	-40	+125	IP20						•	206
		≤ 1 mΩ											
CX 4/0	UL, CSA, CQC, DNV-GL, BV, EAC	≤ 0,3 mΩ	≥10 GΩ	-40	+125	IP20		•					200, 202
CX 4/2	UL, CSA, CQC, DNV-GL, BV, EAC	≤ 0,3 mΩ	≥10 GΩ	-40	+125	IP20		•					201, 203
		≤ 1 mΩ											
CX 4/8	UL, CSA, CQC, DNV-GL, BV, EAC	≤ 0,3 mΩ	≥10 GΩ	-40	+125	IP20		•					204
		≤ 1 mΩ											
CXL 2/4	UL, CSA, DNV-GL, BV	≤ 3 mΩ	≥10 GΩ	-40	+70	IP20			•				332, 333
CLK 04	UL, (CSA), DNV-GL, BV	---	≥10 GΩ	-40	+70	IP20						•	321
CX 1/2 BD	UL, CSA, (CQC), DNV-GL, BV	≤ 1 mΩ (CC)	≥10 GΩ	-40	+70	IP20						•	325
		≤ 3 mΩ (CD)											
		≤ 4 mΩ (CI)											
		≤ 3 mΩ	≥10 GΩ										

## MIXO INSERTS FEATURES

Inserts	No. of poles <sup>1)</sup>	Aux. contacts	Rated current <sup>2)</sup>	EN 61984 (2009-06) pollution degree 3			EN 61984 (2009-06) pollution degree 2			UL/CSA certification	
				Rated voltage	Rated impulse voltage	Pollution degree	Rated voltage	Rated impulse voltage	Pollution degree		Rated voltage AC or DC
CX 01 Y	1 (without PE)	---	200A	1000V	8kV	3	920/1600V	8kV	2	600V	
CX 01 YPE	PE	---	200A	---	---	3				600V	
CX 02 G	2 (without PE)	---	100A	1000V	8kV	3	920/1600V	8kV	2	600V	
CX 01 G	1 (without PE)	---	100A	1000V	8kV	3	920/1600V	8kV	2	600V	
CX 02 7	2 (without PE)	---	70A	1000V	8kV	3	1600V	12kV	2	600V	
CX 02 4A	2 (2,5 - 8 mm <sup>2</sup> ) (without PE)	---	40A	1000V	8kV	3				600V	
CX 02 4B	2 (6 - 10 mm <sup>2</sup> ) (without PE)	---	40A	1000V	8kV	3				600V	
CX 02 4	2 (without PE)	---	40A	1000V	8kV	3				600V	
CX 03 4	3 (without PE)	---	40A	400/690V (*)	6kV	3				600V	
CX 03 4B	3 (without PE)	---	40A	500V (*)	6kV	3				600V	
CX 3/4 XD	3 (without PE)	4	40A	830V	8kV	3				600V	
			10A								
CX 04 X	4 (without PE)	---	40A	830V	8kV	3	1000V	8kV	2	600V	
CX 05 S	5 (without PE)	---	16A	400V	6kV	3	500V	6kV	2	600V	
CX 05 SH	5 (without PE)	---	16A	400V	6kV	3	500V	6kV	2	600V	
CX 06 C	6 (without PE)	---	16A	500V	6kV	3	400/690V	6kV	2	600V	
CX 06P C	6 protected (without PE)	---	16A	830V	8kV	3				600V	
CX 08 C	8 (without PE)	---	16A	400V	6kV	3	400/690V	6kV	2	600V	
CX 20 C	20 (without PE)	---	16A	500V	6kV	3	830V	8kV	2	600V	
CX 12 D	12 (without PE)	---	10A	160V	2,5kV	3	250V	4kV	2	600V	
CX 17 D	17 (without PE)	---	10A	160V	2,5kV	3	250V	4kV	2	250V	
CX 42 D	42 (without PE)	---	10A	150V	2,5kV	3					
CX 02 H	2 (without PE)	---	16A	2900/5000V	15kV	3					
CX 02 CH	2 (without PE)	---	16A	2500V	15kV	3					
CX 25 I	25 (without PE)	---	4A	50V	0,8kV	3	160V	2,5kV	2	600V	
CX 25 IB	25 (without PE)	---	4A	50V	0,8kV	3	160V	2,5kV	2	600V	
CX 03 P	3	---	---	pneumatic contacts for compress air up to 8 barr							
CX 02 P	2	---	---								
CX 02 B	2 (**) (without PE)	---	---	50V	0,8kV	3				50V	
CX 01 B	1 (+ shield) (75 W coax)	---	10A	50V	0,8kV	3				50V	
CX 01 BC	1 (+ shield) (50 W coax)	---	16A	50V	0,8kV	3				50V	
CX 04 B	4 (+ shield)	---	10A	50V	0,8kV	3				50V	
CX 08 B	8 (+ shield)	---	5A	50V	0,8kV	3				50V	
CX 01 J	1 RJ-45 insert Cat. 5	4	---	---	---	---				50V	
			10A	250V	4kV	3				600V	
CX 02 J	2 RJ-45 inserts Cat. 5	8	---	---	---	---				50V	
			10A	250V	4kV	3				600V	
CX 01 J8	1 RJ45 insert Cat. 6	---	---	50V	0,8kV	3				50V	
CX 01 U	1 USB insert	---	1A	50V	0,8kV	3				(50V)	
CX 01 9V	9 (+ shield)	---	5A	50V	0,8kV	3				(50V)	
CX 01 9VTF	2 (+ shield) for RS-485 bus T-connections	---	5A	50V	0,8kV	3				(50V)	
CX 04 L	4	---	---	contacts for POF or MOST <sup>®</sup> fibre optic or crimp coaxial DIN 41626-2							
CX 04 R	4	---	---	crimp coaxial contacts DIN 41626-2							
CX 04 SC	4 (seats/poles)	---	---	contacts for Ø 1 mm plastic POF or MOST <sup>®</sup> fibre optic, coaxial contacts DIN 41626							

<sup>1)</sup> Polarities shown in brackets may be achieved by using two inserts.

<sup>2)</sup> Please check the insert load curves to establish the actual maximum operating current according to the ambient temperature.

<sup>3)</sup> The certifications shown in brackets are being applied for.

<sup>4)</sup> It may be used with ambient temperatures up to 180 °C by using the insert special version made of PPS (polyphenylene sulfide).

Inserts	Certifications <sup>3)</sup>	Contact resistance	Insulation resistance	Ambient temperature limit (°C) <sup>4)</sup>		Degree of protection without enclosures	Conductor connection technology					From page	
							Axial screw	Screw	Spring	Squich®	45° terminal block		Crimp
CX 01 Y	UL, CSA, CQC, DNV-GL, BV, EAC	≤ 0,2 mΩ	≥10 GΩ	-40	+125	IP20						•	232
CX 01 YPE	UL, CSA, CQC, DNV-GL, BV, EAC	≤ 0,2 mΩ	≥10 GΩ	-40	+125	IP20						•	233
CX 02 G	UL, CSA, CQC, DNV-GL, EAC	≤ 0,3 mΩ	≥10 GΩ	-40	+125	IP20						•	235
CX 01 G	(UL), (CSA), (CQC), DNV-GL, BV, EAC	≤ 0,3 mΩ	≥10 GΩ	-40	+125	IP20						•	234
CX 02 7	UL, CSA, CQC, DNV-GL, BV, EAC	≤ 0,5 mΩ	≥10 GΩ	-40	+125	IP20							236
CX 02 4A	UL, CSA, CQC, DNV-GL, BV, EAC	≤ 0,5 mΩ	≥10 GΩ	-40	+125	IP20	•						238
CX 02 4B	UL, CSA, CQC, DNV-GL, BV, EAC	≤ 0,5 mΩ	≥10 GΩ	-40	+125	IP20	•						238
CX 02 4	UL, CSA, CQC, DNV-GL, BV, EAC	≤ 0,3 mΩ	≥10 GΩ	-40	+125	IP20						•	237, 291
CX 03 4	UL, CSA, CQC, DNV-GL, BV, EAC	≤ 0,3 mΩ	≥10 GΩ	-40	+125	IP20						•	239, 292
CX 03 4B	UL, CSA, CQC, DNV-GL, BV, EAC	≤ 0,3 mΩ	≥10 GΩ	-40	+125	IP20						•	240, 293
CX 3/4 XD	UL, CSA, CQC, DNV-GL, BV, EAC	≤ 0,3 mΩ	≥10 GΩ	-40	+125	IP20						•	241, 294
		≤ 3 mΩ											
CX 04 X	UL, CSA, CQC, DNV-GL, BV, EAC	≤ 3 mΩ	≥10 GΩ	-40	+125	IP20			•				242, 295
CX 05 S	UL, CSA, CQC, DNV-GL, BV, EAC	≤ 3 mΩ	≥10 GΩ	-40	+125	IP20			•				243
CX 05 SH	(UL), (CSA), (CQC), (DNV-GL), (BV), (EAC)	≤ 3 mΩ	≥10 GΩ	-40	+125	IP20				•			244
CX 06 C	UL, CSA, CQC, DNV-GL, BV, EAC	≤ 1 mΩ	≥10 GΩ	-40	+125	IP20						•	245, 297
CX 06P C	(UL), (CSA), (CQC), DNV-GL, BV, EAC	≤ 1 mΩ	≥10 GΩ	-40	+125	IP20						•	246, 296
CX 08 C	UL, CSA, CQC, DNV-GL, BV, EAC	≤ 1 mΩ	≥10 GΩ	-40	+125	IP20						•	247, 298
CX 20 C	UL, CSA, CQC, DNV-GL, BV, EAC	≤ 1 mΩ	≥10 GΩ	-40	+125	IP20						•	248, 299
CX 12 D	UL, CSA, CQC, DNV-GL, BV, EAC	≤ 3 mΩ	≥10 GΩ	-40	+125	IP20						•	251, 300
CX 17 D	UL, CSA, CQC, DNV-GL, BV, EAC	≤ 3 mΩ	≥10 GΩ	-40	+125	IP20						•	252, 301
CX 42 D	(UL), (CSA), (CQC), (DNV-GL), (BV), (EAC)	≤ 3 mΩ	≥10 GΩ	-40	+125	IP20						•	253, 302
CX 02 H	(UL), (CSA), (CQC), (DNV-GL), (BV), (EAC)	≤ 1 mΩ	≥10 GΩ	-40	+125	IP20						•	250
CX 02 CH	(UL), (CSA), (CQC), (DNV-GL), (BV), (EAC)	≤ 1 mΩ	≥10 GΩ	-40	+125	IP20						•	249
CX 25 I	UL, (CSA), DNV-GL, BV	≤ 4 mΩ	≥10 GΩ	-40	+125	IP20						•	255
CX 25 IB	(UL), (CSA), DNV-GL, BV	≤ 4 mΩ	≥10 GΩ	-40	+125	IP20						•	254
CX 03 P	UL, CSA, DNV-GL, BV	---	≥10 GΩ	-40	+125	IP20	push-in					282	
CX 02 P	UL, CSA, DNV-GL, BV	---	≥10 GΩ	-40	+125	IP20	push-in					282	
CX 02 B	UL, CSA, CQC, DNV-GL, BV	---	≥10 GΩ	-40	+125	IP20	push-in					258	
CX 01 B	UL, CSA, CQC, DNV-GL, BV	≤ 3 mΩ	≥10 GΩ	-40	+85	IP20						•	261
CX 01 BC	UL, CSA, CQC, DNV-GL, BV	≤ 1 mΩ	≥10 GΩ	-40	+85	IP20						•	259
CX 04 B	UL, CSA, CQC, DNV-GL, BV	≤ 3 mΩ	≥10 GΩ	-40	+85	IP20						•	261
CX 08 B	UL, CSA, (CQC), DNV-GL, BV	≤ 4 mΩ	≥10 GΩ	-40	+85	IP20						•	263
CX 01 J	UL, CSA, CQC, DNV-GL, BV, EAC	≤ 3 mΩ	≥10 GΩ	-40	+120	IP20						•	274
		≤ 3 mΩ	≥10 GΩ	-40	+120	IP20						•	
CX 02 J	UL, CSA, CQC, DNV-GL, BV, EAC	≤ 3 mΩ	≥10 GΩ	-40	+120	IP20						•	276
		≤ 3 mΩ	≥10 GΩ	-40	+120	IP20						•	
CX 01 J8	UL, (CSA), DNV-GL, BV, EAC	≤ 3 mΩ	≥10 GΩ	-40	+70	IP20						•	272
CX 01 U	UL, (CSA), DNV-GL, BV, EAC	≤ 3 mΩ	≥10 GΩ	-28	+80	IP20						•	264
CX 01 9V		---	≥10 GΩ	-40	+70	IP20						•	266
CX 01 9VTF		---	≥10 GΩ	-40	+70	IP20	•						268
CX 04 L	UL, (CSA), (CQC), DNV-GL, BV, EAC	≤ 30 mΩ	≥1 GΩ	-25	+80	IP20							269
CX 04 R	(UL), (CSA), DNV-GL, BV	≤ 15 mΩ	≥5 GΩ	-40	+125	IP20						•	270
CX 04 SC	(UL), (CSA), DNV-GL, BV	---	≥10 GΩ	-40	+85	IP20						•	271

(\*) With cable Ø up to 5 mm (CX 03 4), with cable Ø up to 7,5 mm (CX 03 4B).

(\*\*) Multi-axial shielded connectors CX 04 B (4P, 10A) or CX 08 B (8P, 5A) or coaxial connectors CX 01 B (10A) or CX 01 BC (16A).

## RECOMMENDED TIGHTENING TORQUE

- insert terminal screws, including PE terminal and fixing screws
- axial screw insert, MIXO series CX 02 4A / CX 02 4B
- enclosures assembly screws

### Insert terminal screws, including PE terminal and fixing screws

Increasing the tightening torque of terminal screws does not considerably improve the contact resistance. The screw torques are selected according to standard EN 60999-1, to provide excellent mechanical, thermal and electric behaviour. The conductor or terminal may be damaged if the recommended values are significantly exceeded.

Screw size	Connector type	Recommended tightening		Recommended size of screwdriver
		(Nm)	(lb.in)	
<b>LINE TERMINALS</b>				
M2,5	CT 40, 64	0,4	3,5	0,5 x 3
M2,6	CT 06...24	0,4	3,5	0,5 x 3
M3	CDA	0,5	4,4	Ph0 or 0,6 x 3,5
M3	CNE, CME	0,5	4,4	Ph0 or 0,8 x 4
M3	CX 4/2, CX 4/8 (16A)	0,5	4,4	0,6 x 3,5
M3	CX 4/8 Q (16A)	0,5	4,4	Ph0
M4	CP	1,2	10,6	Ph1 or 0,8 x 4
M6	CX 4/... (80A)	2,5	22,1	1,0 x 5,5
<b>PE TERMINAL</b>				
M3	CQ 05, CQ 07, CQ 12	0,5	4,4	0,5x3
M4	all series except CDA, CDC, CSAH, MIXO, CP	1,2	10,6	Ph2 or 1,0 x 5,5
M3,5	series CD 15, CD 25, CDA, CDC, CSAH	0,8	7,1	Ph1 or 1,0 x 5,5
M3	small PE terminal, MIXO frames series	0,5	4,4	Ph1 or 1,0 x 5,5
M4	large PE terminal, MIXO frames series	1,2	10,6	Ph1 or 1,0 x 5,5
M4	PE terminal, MIXO ONE enclosures	1,2	10,6	Ph1 or 1,0 x 5,5
<b>FASTENING SCREWS</b>				
M3	CK, CKS, CKSH, CD 07, CD 08, CQ 05, CQ 07, CQ 12, CQ 21, CQ4 02 /02 H, CQ4 03, CX 1/2 BD	0,5	4,4	0,5 x 3
M3	screw for fastening inserts to enclosures of all series except T-Type, CQ-MQ 08 and MIXO ONE	0,8	7,1	Ph1 or 0,8 x 4
Ø 2,9	screws for fastening "32.13" inserts CQ 04/2, CQ 08, CQ 17 to CQ-MQ 08 enclosures	0,7	6,2	Ph1
M3	screw for fastening inserts to T-Type enclosures	0,5	4,4	Ph1 or 0,8 x 4
Ø2,9	series MIXO ONE enclosures, assembly of top and bottom parts	0,8	7,1	Ph1
M4	CYR 16.3, CYR 24.4 cable pass-through hoods, assembly of two halves	1,2	10,6	Ph2 or 1,0 x 6
M4	CYG 16 in-line joint, assembly of two halves and mounting of two bulkhead mounting housings size "77.27"	1,2	10,6	Ph2 or 1,0 x 6
M5	series BIG enclosures, assembly of top and bottom parts	0,8 – 1,0	7,1 – 8,8	Ph2

### Axial screw insert, MIXO series CX 02 4A / CX 02 4B

The connections of the conductors to the female and male inserts are made via axial screw. Fully insert the stripped wire in the back of the contact (axial screw terminals are supplied fully opened); while holding the wire down, insert a 2 mm hexagonal key in the front of the contact and tighten to recommended torque. After assembling the complete connector periodically check that the contact is screwed tight by re-applying the proper tightening torque.

- Usable conductor cross-sections (EN 60228 Class 5):
  - from 2,5 to 8 mm<sup>2</sup> (14 AWG to 10 AWG) (CX 02 4AF/M)
  - from 6 to 10 mm<sup>2</sup> (10 AWG to 8 AWG) (CX 02 4BF/M)
  - (extra-flexible EN 60228 class 6: 2.5... 6 mm<sup>2</sup> (14 AWG to 10 AWG))
- Use only stranded flexible copper conductors
- Do not twist the strands!
- Tightening torque with 2 mm hexagonal Allen key:
  - 1,5 Nm (13,3 lb.in) max for conductors with section 2,5 ... 4 mm<sup>2</sup> (14 AWG to 12 AWG)
  - 2 Nm (17,7 lb.in) max for conductors with section 6 ... 10 mm<sup>2</sup> (10 AWG to 8 AWG)
- Stripping length: 8<sup>+1</sup> mm

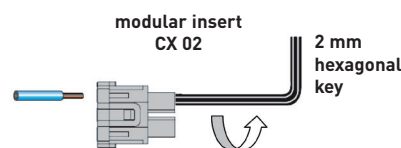

## Enclosures assembly screws

In the table below, the recommended minimum and maximum tightening torque to apply to the fixing screws of ILME bulkhead mounting housings are shown, assuming the use of steel screws (bolts) with 8.8 resistance class and a good fixing panel surface according to the requirements mentioned therein.

Series	Number of screws	Screw size	Recommended torque		Flange sealing element
			(Nm)	(lb.in)	
CK/MK, CKA/MKA, CQ	2	M3	0,8 – 1,0	7,1 – 8,9	Gasket
MIXO ONE	4	M3	TBA	TBA	Gasket
CZI 15 /25	4	M3	0,8 – 1,0	7,1 – 8,9	Gasket
CHI 50	4	M4	1,2 – 1,8	10,6 – 15,9	Gasket
CHI 06 /10 /16 /24	4	M4	0,8 – 1,2	7,1 – 8,9	Gasket
CHI 32	4	M4	1,2 – 1,8	10,6 – 15,9	Gasket
CHI 48	4	M6	3,0 – 3,6	26,6 – 31,9	Gasket
CGK/MGK (IP68)	2	M4	0,8 – 1,2	7,1 – 8,9	O-ring
CGI/ MGI 06/ 10/ 16/ 24 (IP68)	2	M6	3,0 – 3,6	26,6 – 31,9	O-ring
T-Type, T-Type H, T-Type C, T-Type W	4	M4	0,8 – 1,2	7,1 – 8,9	Gasket

To guarantee the declared IP degree of protection of the housings reported in this catalogue, according to EN IEC 60529 or to the relevant Type rating per ANSI/UL 50 and 50E (for those products bearing approval to those ratings), the surface of the mounting panel must meet the following requirements (definitions are provided in ISO 4287 standard):

- Waviness  $Wt \leq 0,2$  mm over a distance of 200 mm (measured on the panel without load)
- Roughness  $Ra \leq 16$   $\mu$ m

NOTE: The values of tightening torque indicated in the above table are just recommended values, that must be related – by the designer of the final application – to the resistance class of the screws (not included in the delivery), with the assumption that the mounting panel is sufficiently rigid (stiff). If the deflection of the panel, under the effect of tightening the screws, is greater than 0,7 mm over a distance of 100 mm, it is necessary to use the counter-flanges mentioned in our catalogue or the special flange gaskets available upon request (please contact our Sales Department). For the CGI/MGI IP68 enclosures the specific counter-flanges mentioned in our catalogue are always recommended.

## RANGE OF CONDUCTOR CROSS-SECTIONAL AREA AND STRIPPING LENGTH

Connector inserts connection technique	Range of conductor cross-sectional area		Stripping length (mm)
	(mm <sup>2</sup> )	AWG	
<b>Screw</b>			
CK	0,75 – 2,5	18 – 14	6
CX 4/2, CX 4/8 (poles 16A) <sup>1)</sup>	0,75 – 4	18 – 12	7
	0,75 – 2,5	18 – 14	7
CNE <sup>1)</sup>	0,5 – 4	20 – 12	7
CNE..X	0,25 – 2,5	24 – 14	7
CDA <sup>1)</sup>	0,5 – 4	20 – 12	7
CDA..X	0,25 – 2,5	24 – 14	7
CT 06...24	0,75 – 2,5	18 – 14	12
CT 40 and 64	0,75 – 2,5	18 – 14	12
CME <sup>1)</sup>	0,5 – 4	20 – 12	7
CME..X	0,5 – 2,5	20 – 14	7
CP <sup>1)</sup>	0,75 – 6	18 – 10	10,5
CX 4/.. (80A poles)	4 – 16	12 – 5	14
<b>Crimp</b>			
MIXO (5A), CQ 21	0,08 – 0,52	28 – 20	4
CDD, CD, MIXO (10A), CQ 12, CQ 07	0,14 – 2,5 *	26 – 14	8 (* 6 for 2,5 mm <sup>2</sup> )
CCE, CDC, CMCE, CQ, CQE, CQEE, MIXO (16A)	0,14 – 4	26 – 12	7,5
CX, MIXO (40A), CQ4 03	1,5 – 2,5	16 – 14	9
	4 – 6	12 – 10	9,6
MIXO (70A)	10 – 25	7 – 4	15
MIXO (100A), CX 6/6	10 – 35	7 - 2	15
MIXO (200A)	16 – 70	6 - 2/0	15
<b>Spring</b>			
CSE, CSH, CTSE 06..24, CMSH, MIXO (CX 05 S), CSS	0,14 – 2,5	26 – 14	9 - 11
CTS 40/64	0,14 – 2,5 unprepared	26 – 14 unprepared	9 - 11
	0,14 – 1 prepared	26 – 18 prepared	
CKS, CKSH, CDS, CDSH, CSAH	0,14 – 2,5 unprepared	26 – 14 unprepared	9 - 11
	0,14 – 1,5 prepared	26 – 16 prepared	

<sup>1)</sup> For CNE, CDA, CP, CME, "CX 4/8 – pole 16A" series connectors with screw terminal and conductor protection plate, the use of ferrules is not necessary (= unprepared conductor). The use of ferrules (= prepared conductor) causes a reduction in maximum useful cross-section to the lower size (e.g. 4 mm<sup>2</sup> unprepared - 2,5 mm<sup>2</sup> prepared).

# CONDUCTOR CONNECTION TECHNOLOGY

## SCREW

 For all inserts with screw terminals it is important that the right torsional torque is applied to the screws in order to prevent wrong contacts or damage to the conductor, the screw or the terminal.

 The **10A and 16A crimp contacts** are available either silver or gold-plated.

The **gold-plated crimp contacts** are recommended for applications with very low rated currents and rated voltages. Thanks to the conduction characteristics of gold, the deterioration of signals is prevented and an excellent residence to the superficial oxidation of the contacts is obtained. In particular, gold-plated contacts are recommended with signals with  $\leq 5$  mA current and  $\leq 5$  V voltage.

With screw terminal connections with or without wire protection

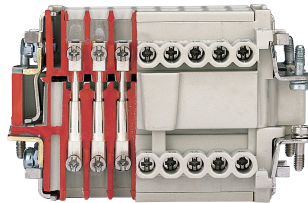

**CK - CDA - CNE - CME - CP - CX**

The connections of the conductors to the female and male inserts are made via screws (in accordance with standard EN 60999-1).

Two different types of clamping are possible:

- with pressure plate for unprepared conductors;
- without wire protection that requires the conductors to be prepared with bush terminals.

**Clamping types**

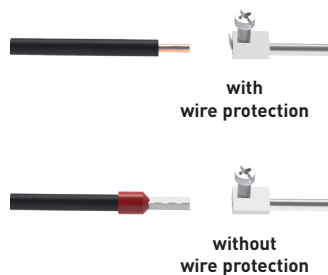

**CX..A / CX..B**

The connections of the conductors to the female and male inserts is made via screws in accordance with standard.

Fully insert the wire in the back of the contact; insert a 2 mm hexagonal key in the front of the contact and tighten by holding down the cable (page 20).

Screw connected in built-in terminal block

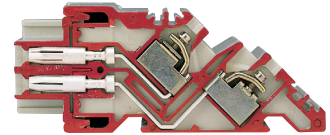

**CT**

In this layout the wires are connected to the socket and plug insert contacts by means of a screw for all CT inserts (in compliance with EN 60999-1).

The inserts contain:

- a terminal block at 45° for fixed installation on electrical panels or on built-in DIN EN 60715 rail, for easier wire cabling and identification operations
- screw connection with pressure plate which does not require the wires to be prepared (CT inserts).

**CT connection technology**

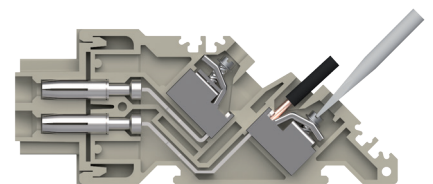



## INCORPORATED TERMINAL BLOCK

### Connection technology

**step 1**  
When the screwdriver is inserted in the square housing provided, the wire housing in the spring is opened

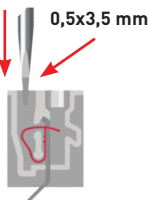

**step 2**  
The wire is pushed all the way in the round housing provided

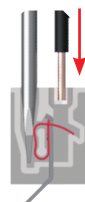

**step 3**  
When the screwdriver is removed, the spring is held down on the inserted wire



**step 4**  
The connection is complete; pull on the wire to make sure that the spring firmly holds down the wire



### Built-in terminal block

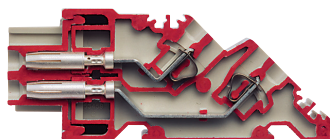

### CTSE - CTS

With terminal block at 45° built-in for fixed installation on electrical panels or on built-in DIN EN 60715 rail, for easier wire cabling and identification operations.

Spring terminal connection which does not require wire preparation (CTSE inserts).

### CTSE connection technology

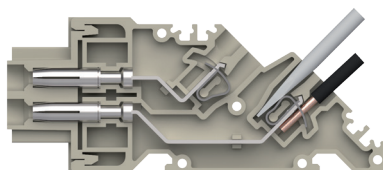

### Dual spring terminal

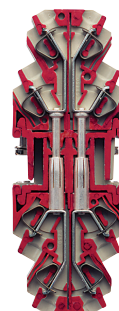

### CSS

Equipped with two terminals per contact.

This type of connection allows a circuit to be branched off.

### CSS connection technology

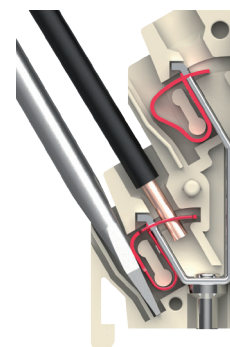

0,5 x 3,5 mm blade



## SQUICH® - SPRING

### Connection without tools

**Q** The wires are connected to the insert contacts by a spring terminal with patented actuator button.

#### Key advantages:

- ☑ No special wire preparation, other than stripping
- ☑ No need for wiring tools
- ☑ Excellent fastening solution and great resistance to strong vibrations
- ☑ Suitable for solid and flexible wires, both ferruled and unferruled, with a cross sectional area range of 0,14 mm<sup>2</sup> to 2,5 mm<sup>2</sup>
- ☑ Reduced wiring time, up to 50%
- ☑ Correct wiring can be checked by inserting a test probe into the perforated shape of the actuator buttons

#### SQUICH® - spring

### Connection technology

#### WIRING

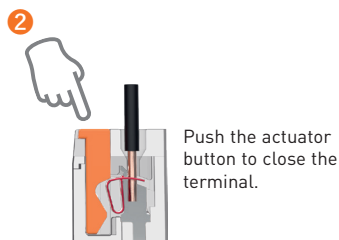
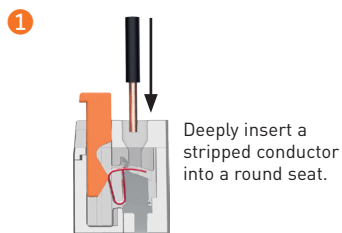

#### RE-OPENING

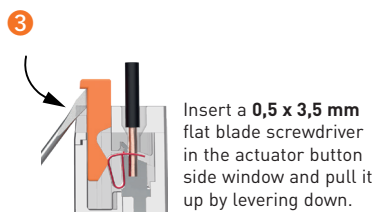

### Spring connected contacts with actuator button

#### SQUICH®

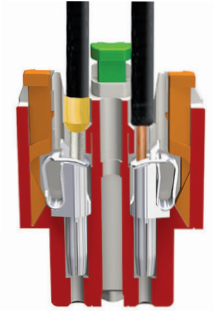

#### CKSH

All the advantages of SQUICH® connection technology in size "21.21". Vertical and straight termination and dedicated coding pins.

### Spring connected contacts with actuator button

#### SQUICH®



#### CSH

Parent insert of the connection technology. Quick, simple and safe wiring for a practically error-free installation.

#### CMSH

Specific version for voltages up to 830 V. The CMSH inserts can be used with all types of enclosures.



### Spring connected contacts with actuator button

SQUICH®

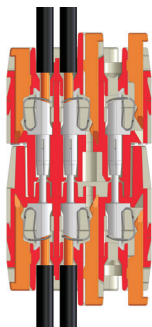

#### CDSH

High density without tools. The CDSH insert is the answer to the continuous demand for greater number of poles and smaller dimensions. It offers a maximum number of 84 poles in the same space of standard series. Inserts can be coded by CR CDS pin to avoid incorrect coupling.

### Spring clamp contacts with actuator button, with NC shorting contacts

SQUICH®

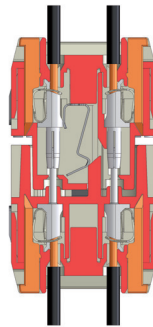

#### CDSH NC

The AutoShort connector, suitable for interfacing measuring current transformers. 3 pair of contacts with AutoShort NC (normally closed) element to protect the measuring current transformer's secondary windings. It can be used either with metal or thermoplastics enclosures, size "44.27".

### Spring connected contacts with actuator button

SQUICH®



#### CSAH

This version implements the SQUICH® concept in a miniaturized version with a high contact density. Slim design for 400V needs. Inserts can be mated with CDA/CDC series.

## CRIMP

### Removable crimp contacts (with retention device)



#### MIXO 70A - 100A - 200A

This layout enables the wires to be connected to the insert removable contacts by crimping them with a crimp tool and its locating turret. Connection is ensured and is **extremely resistant** even to the most insidious strains, such as vibrations.

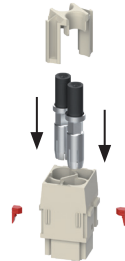

#### MIXO 70A/100A max contacts

Conductor section		Identification
(mm <sup>2</sup> )	AWG	hole Ø (mm)
8 - 10	8 - 7	4,3
16	6 - 5	5,5
25	4 - 3	7,0
35	2	7,9 / 8,2

#### MIXO 200A max contacts

Conductor section		Identification
(mm <sup>2</sup> )	AWG	
16	6	
25	4	
35	2	
50	1	
70	2/0	

☑ Contacts supplied in silver lated version only

### Removable crimp contacts (with retention device on contacts)

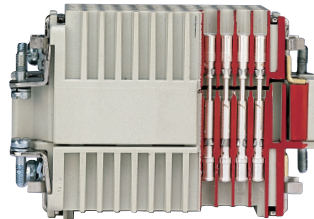

#### MIXO CD - CDD - CX

This layout enables the wires to be connected to the insert removable contacts by crimping them with a crimp tool and its locating turret.

The crimped connections are then inserted (with a fitting tool for sizes 1 and 2, without any tools for sizes ②, 3, 4 and 5) in the above mentioned sizes and are kept firmly in place by means of the flexible device fitted on the contacts. The wire housing entry on the contact is tapered to facilitate wire insertion and to avoid any damages occurring after the crimping operation. To remove connections, a special **extractor tool** must be used.

#### 4A/5A/6,5A max contacts

Conductor section		Identification
(mm <sup>2</sup> )	AWG	hole Ø (mm)
0,08 - 0,21	28 - 24	0,64 mm
0,13 - 0,33	26 - 22	0,90 mm
0,33 - 0,52	22 - 20	1,12 mm
0,52 - 0,75	20 - 18	1,12 mm

#### 10A max contacts

Conductor section		Number Identification
(mm <sup>2</sup> )	AWG	
0.14 - 0.37	26 - 22	
0.5	20	
0.75	18	
1	18	
1.5	16	
2.5	14	

☑ Contacts supplied in both silver/gold plated versions

### Removable crimp contacts (with retention device inside insert)



#### MIXO CQ - CQE - CCE - CDC - CMCE - CX

The connections of the conductors to the removable contacts of the male and female inserts are made via crimping with a crimping tool and locator. The crimped connections are then introduced in the inserts of the above mentioned series and are **firmly held in place** by means of a retainer device fitted on the insert which holds down the contact. The contact can be removed by simply using a flat head 3 mm screwdriver through the openings provided in the inserts (CMCE 16+2, CX 8/24 series) or by means of special extractor tools, to unlock the retainer device and release the contact (CQ, CCE, CMCE, CQE, CX, CDC, MIXO series). The wire housing entry on the contact is tapered to facilitate wire insertion and to avoid any damages occurring after the crimping operation.

#### 16A max contacts

Conductor section		Throat Identification
(mm <sup>2</sup> )	AWG	
0.14 - 0.37	26 - 22	
0.5	20	
0.75	18	
1	18	
1.5	16	
2.5	14	
3	12	
4	12	

☑ Contacts supplied in both silver /gold plated versions. Male contacts can also be supplied in the advanced" version and iron/constantan contacts for thermocouples J type.

#### 40A max contacts

Conductor section		Identification
(mm <sup>2</sup> )	AWG	hole Ø (mm)
1,5	16	1,75
2,5	14	2,25
4	12	2,85
6	10	3,5

☑ MIXO above contacts are supplied in the silver plated version only

## CRIMP CONTACTS OVERVIEW

The 4/6,5A, 10A and 16A crimp contacts are available either **silver or gold-plated**. The gold-plated crimp contacts are recommended for applications with very low rated currents and rated voltages.

Thanks to the conduction characteristics of gold, the deterioration of signals is prevented and an excellent resistance to the surface oxidation of the contacts is achieved. In particular, gold-plated contacts are recommended with signals with less than  $\pm 5$  mA current and  $\pm 5$  V voltage.

Standard ILME **gold treatment** is carried out in accordance with MIL-G-45204C Class 00, Type II, Grade C and ASTM B428-01 Class 0.5, Type II, Grade C.

The new basic or high thickness gold-plated contacts are in compliance with EN 61984: 2009, IEC 60512 and EN 60352-2:1994 (such as the standard version)

### CRIMP SILVER PLATED

**4-6,5A**



**10A**



**16A**

Normal and for advanced opening



**10-40-70-100-200A**



### CRIMP GOLD PLATED

**10-16A**  
Standard



**10-16-40A**  
HNM (High Number of Matings)



**10-16A**  
High thickness



**CI 4-6,5A**  
For very high density inserts



### CRIMP IRON/CONSTANTAN THERMOCOUPLE

**Constantan (Cu Ni) and Iron (Fe)**  
According to IEC 60584-1 type J



### CRIMP POF/MOST

**For POF/MOST Optic Fibers**  
POF 1,0 mm  
and MOST 1/1,5 mm



### COAXIAL TO CRIMP

50 $\Omega$  - 75 $\Omega$   
according to DIN 41626-2



## LOAD CURVES

The permitted current carrying capacity for connectors is variable: it becomes lower with the increase of the number of poles and of the ambient temperature in which the connector is installed and it depends upon the thermal properties of the material used for the contacts and the insulating parts including those of the type of conductor used. The current carrying capacity is obtained from the load curves which are constructed according to standard IEC 60512-5-2 for currents circulating simultaneously in all poles.

The limit current curves express current values that determine the achievement of the upper limit temperature of the materials. The choice of the permanent load applicable on the contacts **must be made within the field of operation possible delimited by the above mentioned curves.**

Since use of connectors at the limit values of their characteristics is not recommended, the **base curve** is de-rated. The reduction of the load currents to 80% defines the correction curve where both the maximum permissible contact resistances and the inaccuracy of the temperature measurements are sufficiently taken into consideration.

The correction curve represents the final **limit current curve (load curve)** as defined by standard IEC 60512-5-2. It therefore bears in consideration the differences between the various connector inserts, as well as errors in the temperature measurements.

All the load curves presented in this catalogue include the correction. See figure below.

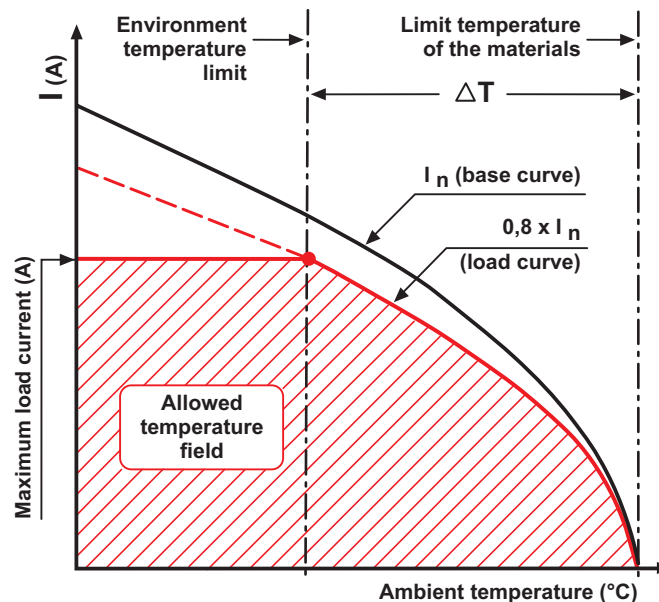

### Legend

#### Maximum load current (A)

Value for which the connector reaches the upper limit temperature of the material at the corresponding ambient temperature intersected on the load curve.

#### Limit temperature of the materials

Value determined by the characteristics of the material used. The sum of the environmental temperature and the increase of the  $\Delta T$  (temperature rise) caused by the current flow must not exceed the limit temperature of the materials.

#### Environment temperature limit

The environmental conditions must not exceed this value. It may be known and determines the maximum load current, or it may be directly obtained from the load curve.

#### Base curve

Set of current and temperature values obtained from laboratory tests and influenced by the connector's characteristics (number of poles, construction shape, thermal conductivity of the materials, etc.) and the cross-section of the conductor used.

#### Load curve (limit current curve)

Obtained from the base curve via the safety coefficient.

#### $\Delta T$ (temperature rise)

Temperature rise produced by a permanent current circulating through all the poles of a connector coupling; difference between the upper limit temperature of the material and the ambient temperature obtained on the limit current curve.



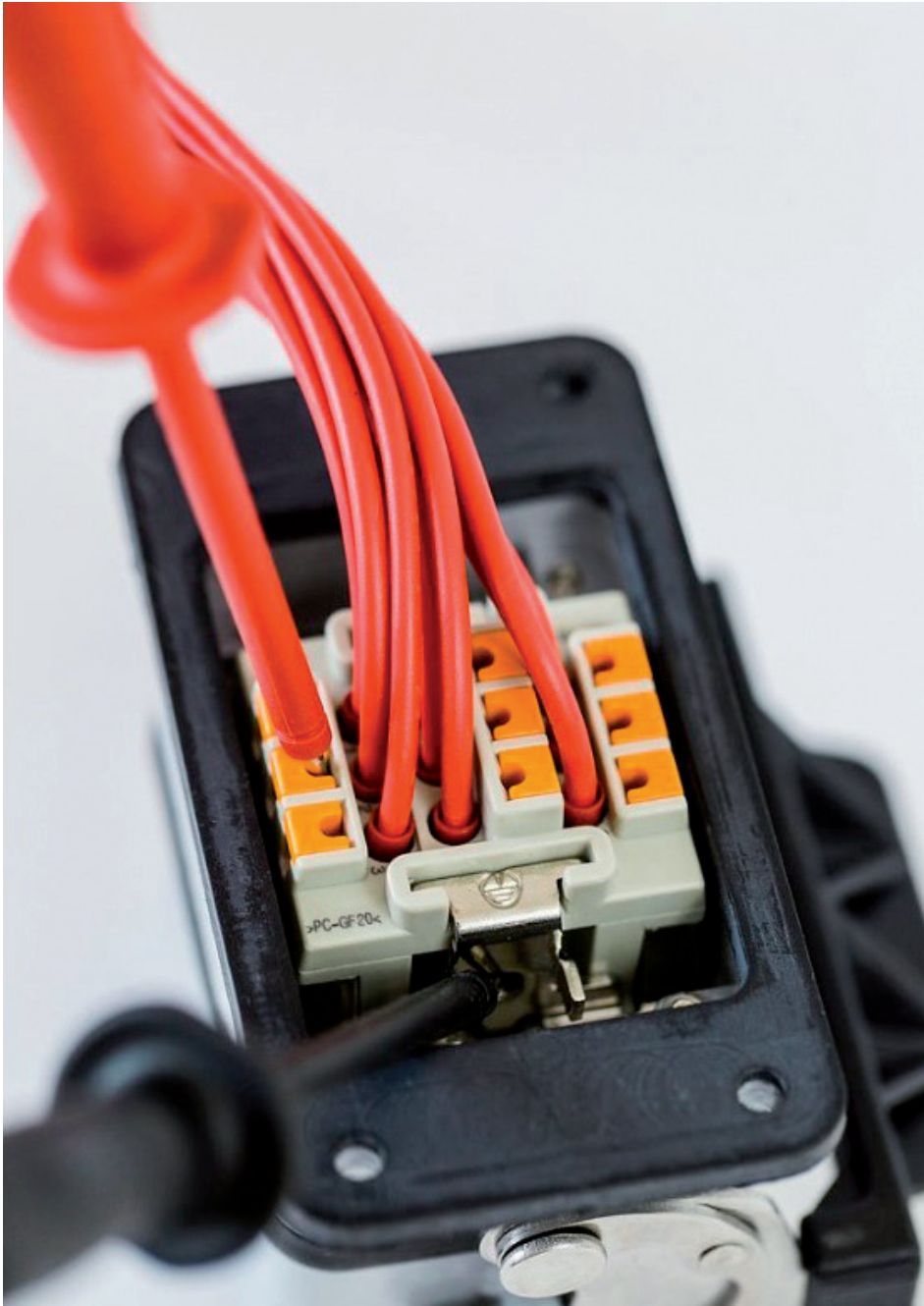

## TYPE OF ENCLOSURES

A large number of enclosure versions are available with different combinations of component materials, each one suitable for a specific environmental installation conditions: standard, high temperature, aggressive and electromagnetic compatibility. The principal parts are made in die cast aluminium alloy with a coating of epoxy-polyester powder or in self-extinguishing thermoplastic insulating. They are resistant to impacts and strong mechanical stress.

The coupling stability and protection against accidental opening are assured by single or double closing devices comprising levers, springs and pegs in stainless steel or entirely in plastic. Sealing is assured by special gaskets that protect the connectors inside the enclosures against dust and aggressive agents. In general, the coupled enclosures with the appropriate user-selected connections guarantee IP44, IP65, IP66 and IP69 (IEC/EN 60529) protection rating and some series can reach IP67 and IP68 protection degree.

### STANDARD USE



#### C-TYPE

The classic choice



#### IL-BRID

Soft closing, strong hold



#### T-TYPE

The high-end plastic solution



#### CK-CKA-MKA

The most compact



#### CQ

Insulating

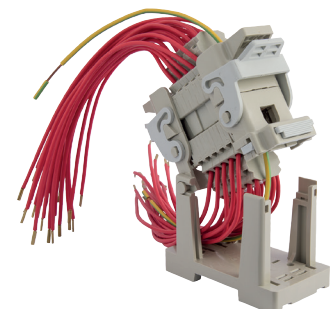

#### COB

Functionality counts

## WATERTIGHT IP67



**V-TYPE IP67**  
Extra tough

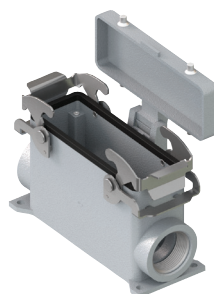

**C7 IP66/IP67**  
Vertical closing



**CZ7 IP66/IP67**  
Rigid coupling

## WATERTIGHT IP68



**IP68 - CGK**  
High protection



**IP68**  
The diving master

## AGGRESSIVE ENVIRONMENTS



**T-TYPE / W**  
For aggressive environments

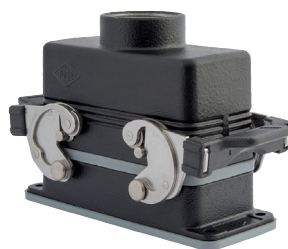

**W-TYPE**  
A cornerstone against corrosion



**E-Xtreme®**  
Protection and beyond

## SPECIFIC USE



### HYGIENIC

Safe for food



### LS-TYPE

For Light and Sound



### BIG - HOODS

The space you have always needed

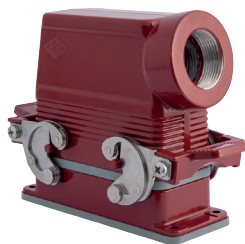

### 180 °C

The heat shield



### EMC

No interferences



### CENTRAL LEVER

Easy access for robotics



### 830V

High voltage version



### HNM

High number of matings

## APPLICATION SECTORS

ILME products apply in many different sectors, they are engineered and tested to provide specific solutions for different environments.

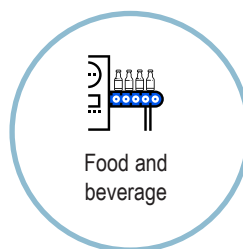
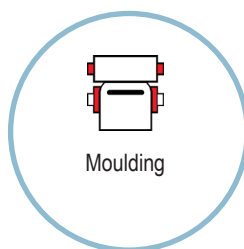
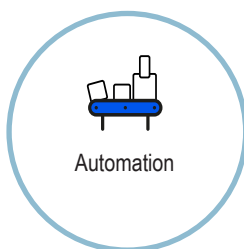
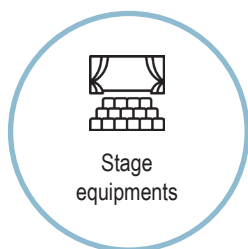
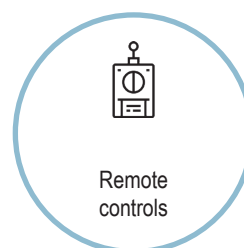
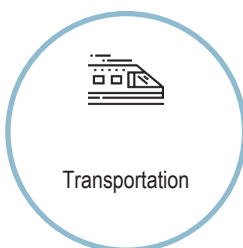
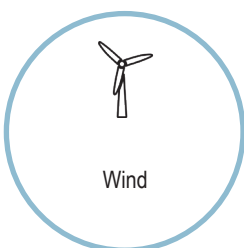
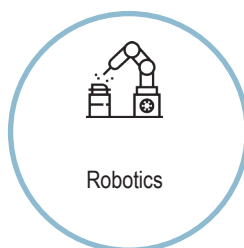
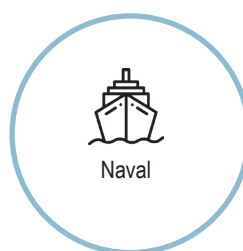
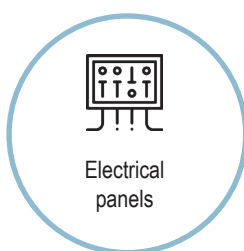



# LOCKING SYSTEMS

## C-TYPE

Classic and flexible

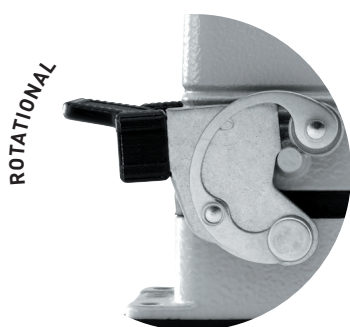

### USED FOR ENCLOSURES:

- C-TYPE (IP65 or IP66)
- W-TYPE (IP65 or IP66)  
for aggressive environments
- 180 °C (IP65) for high temperatures with a completely metallic lever
- EMC (IP65 or IP66) for electromagnetic compatibility
- INSULATED 830V (IP65 or IP66) for CME 830V inserts

## C7

Vertical closing  
up to IP67

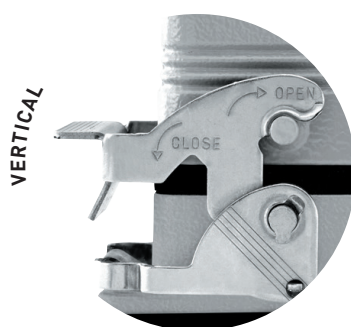

### USED FOR ENCLOSURES:

- C7 (IP66/IP67) stainless steel levers
- CV (IP65 or IP66) stainless steel levers

## T-TYPE

Thermoplastic lever

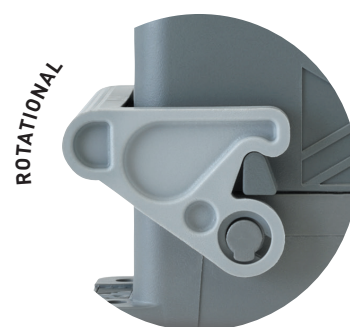

### USED FOR ENCLOSURES:

- T-TYPE (IP65)
- T-TYPE/W (IP66)
- HYGIENIC: T-TYPE/H, T-TYPE/C (IP66/IP69)
- LS-TYPE (IP65)

## IL-BRID

The coordinated effect  
of two works



### USED FOR ENCLOSURES:

- IL-BRID (IP66)

## CZ7

Rigid locking lever  
in stainless steel

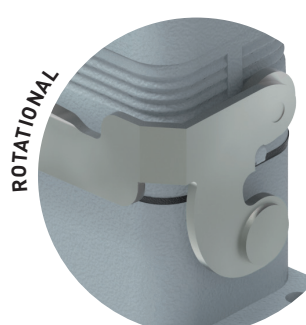

### USED FOR ENCLOSURES:

- IL-BRID (IP67)

## TYPE OF COVERS

### 2-POSITION OPEN/CLOSED, HINGED

#### WHITE THERMOPLASTIC

LP / CP

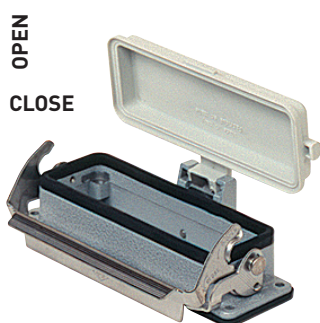

**USED FOR ENCLOSURES:**

- C-TYPE ( housings with levers)
- CV ( housings with lever)

#### METAL VERSION

LS / CS

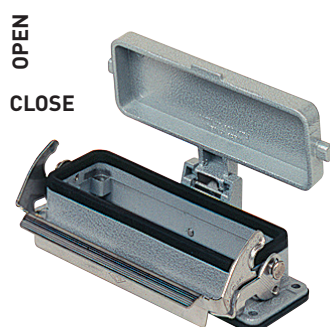

**USED FOR ENCLOSURES:**

- C-TYPE ( housings with levers)
- CV ( housings with lever)

#### METAL VERSION

LS / CS

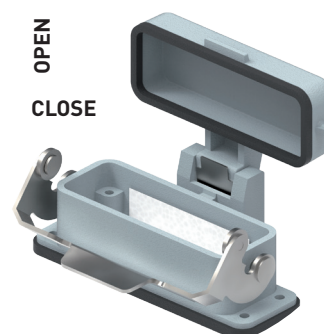

**USED FOR ENCLOSURES:**

- C7 housings with levers

### SIMPLEX SELF-CLOSING, HINGED

#### BLACK THERMOPLASTIC

LSP



**USED FOR ENCLOSURES:**

- CV ( housings with lever)

#### BLACK THERMOPLASTIC

LSP



**USED FOR ENCLOSURES:**

- CZ ( housings with lever)

#### METAL VERSION

LS



**USED FOR ENCLOSURES:**

- CKA ( housings with lever)

## TYPE OF HOODS / HOUSINGS

### C-TYPE



This series has been developed for application in electrical and electronic machinery, control units, electrical panels, control equipment, in industrial environments and in general, wherever a reliable and easily disconnectable connection is required for power and signal circuits.

#### ✎ Functional characteristics

- Wear of pins greatly reduced by the presence of rolls, that provide a smooth closure;
- resilience of double spring mechanism for automatic compensation of any coupling tolerance;
- the inserts of the CMCE series (except the 16+2 poles) and of the CMSH series may use standard enclosures also for uses of up to 830V.

- ✓ UL certified for USA and Canada for Type 4, 4X (outdoor use) and 12 (indoor use) degrees of protection (enclosure type rating), marked on the packaging.  
IP65 or IP66/IP69 degrees of protection according to model.

#### ✎ Characteristics of materials for CH, CA and MH, MA, MF series

- Made of die cast aluminium alloy;
- with epoxy-polyester thermosetting powder coating;
- gaskets in anti-aging, oil-resistant, grease-resistant and fuel-resistant vinyl nitrile elastomer;
- locking device with levers, springs, rolls and pins in stainless steel;
- lever handles in self-extinguishing thermoplastic material reinforced with glass fibres, UL approved (for CH, CA and MH, MA enclosures);
- ambient temperature range: -40 °C / +125 °C.

### V-TYPE IP67



This original design locking lever, due to the vertical closing movement, offers an IP66/IP67/IP69 degree of protection according to EN 60529 when fitted with a complete and coupled connector using ILME standard aluminium hoods (without adaptor) with die cast pegs.

#### ✎ Functional characteristics

- The friction on the pin is virtually zero as the locking lever exerts its pressure vertically, thus significantly reducing wear in case of frequent use;
- this locking lever can be used for applications with vibrations because it has no springs, hence resulting more rigid;
- this locking lever occupies a very small space during the closing phase;
- it is recommended in cases in which the weight of the cable tends to open elastic locking levers, like with vertically installed connectors and downwards cable exit;
- the absence of plastic parts provides better resistance in case of shocks and exposure to chemical contamination or risk of fire.

- ✓ UL certified for USA and Canada for Type 4, 4X (outdoor use) and 12 (indoor use) degrees of protection (enclosure type ratings), marked on the packaging.  
IP66/IP67/IP69 degree of protection.

#### ✎ Characteristics of materials for C7, C7A and M7, M7A series

- Made of die cast aluminium alloy;
- with epoxy-polyester thermosetting powder coating;
- gaskets in anti-aging, oil-resistant, grease-resistant and fuel-resistant vinyl nitrile elastomer;
- locking device fully in stainless steel;
- ambient temperature range: -40 °C / +125 °C

### T-TYPE AND T-TYPE/W



Alongside the wide range of traditional metallic enclosures for multipole connectors, ILME was a pioneer in offering a new series of enclosures in self-extinguishing thermoplastic material in the most common sizes of "44.27", "57.27", "77.27" and "104.27".

#### ✎ Functional characteristics

- Pre-fastened gaskets for easier installation;
- external dimensions of the bulkhead housing are similar to those of the corresponding metal enclosures and hole fixing centres are unchanged;
- ample space inside enclosures for cables, with mounted connectors, similar to the corresponding metal high construction versions;
- possibility of making completely insulated constructions (equivalent to Class II);
- absence of powder paint for environments in which these are not recommended;
- manufactured from insulating material, do not require special reinforced insulation as the metal versions do, for use with series CME 830V higher voltage connector inserts (screw-type terminals).

- ✓ UL Type 12 degree of protection (enclosure type rating) according to ANSI/UL 50E.  
IP65/IP69 (T-Type standard and Hygienic).  
IP66/IP69 (T-Type /W) degree of protection.

#### ✎ Characteristics of materials for T-TYPE and T-TYPE/W series

- Enclosures in thermoplastic material, dark grey RAL 7012 colour, with high thicknesses providing structural solidity and durability;
- **T-TYPE series: built-in polyurethane gaskets;**
- **T-TYPE/W series: built-in FKM fluoroelastomer sealing gaskets;**
- locking levers in thermoplastic material colour grey RAL 7001;
- M25, M32 and M40 threaded cable entries;
- each enclosure carries its own part number, thread/size, conformity markings and UL type rating;
- ambient temperature range: -40 °C / +90 °C.

✎ T-TYPE/W series have been developed for industrial applications with particularly aggressive external agents (e.g. salt atmospheres or environments).

Q As the characterizing element of the T-TYPE/W series is the different sealing gasket material, hoods and covers without sealing gaskets for these series are the same of T-TYPE Standard.

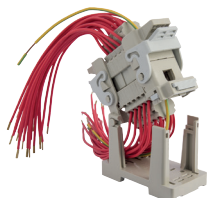
**COB**

The COB system makes it possible to use multipole connectors within electrical panels without the traditional metallic enclosure, as environmental protection is assured by the electrical panel itself or other container.

Q Connectors must not be operated live.

**Functional characteristics**

- The system may be assembled on panels with window snap fastening device; on DIN EN 60715 rails, both lengthways and crossways to the support; on fixed panels using screws;
- reduction in cost and space with respect to metallic enclosures and traditional terminal boards;
- possibility of rewiring at the connector bench with connected devices;
- easy wiring inspection and tests with coupled connectors, thanks to rear access to the inserts via the turnover device;
- fast mounting in panels thanks to the snap fastening device on the DIN EN 60715 rails;
- sturdy support structure, specific to the size of each insert and does not require any preparation;
- broad passage for housing of conductor cables;
- mobile parts prearranged for the clamping of bundles of conductors of multipolar cables to prevent contact with the connector contacts

✓ IP20 degree of protection.

**Characteristics of materials for COB system supports**

- Self-extinguishing thermoplastic insulating materials, UL certified (COB supports, locking levers, hoods), compatible with the -40 °C / +125 °C operating temperature range of connector inserts;

**IL-BRID**

Through its original design, the IL-BRID locking lever combines the smoothness of the thermoplastic material with the sturdiness of the stainless steel spring; it has also a linear design which favours a quick wash without retaining external elements.

**Functional characteristics**

- **Soft closing:** in the first phase, the thermoplastic locking lever component comes into play: sliding the new locking lever on the pin reduces friction and wear. It is suitable in all applications with frequent opening and closing.
- **Strong hold:** after the first closing phase involving the plastic component, the stainless steel hook intervenes to guarantee higher resistance to mechanical stress.

✓ IP66/IP69 degree of protection.

**Characteristics of materials for CZ and MZ series**

- Made of die cast aluminium alloy;
- with epoxy-polyester powder coating;
- gaskets in anti-aging, oil-resistant, grease-resistant and fuel-resistant vinyl nitrile elastomer;
- locking device with levers and springs in stainless steel;
- lever handles in self-extinguishing thermoplastic material reinforced with glass fibres, UL approved (for CZ and MZ enclosures)

**C7/CZ7 IP67**

Enclosures with rigid stainless steel lever to assure an IP66/IP67/IP69 dust and watertight seal.

**Functional characteristics**

- **C7 series: V-TYPE stainless steel locking lever, vertical closing**
- sizes 44.27, 57.27, 77.27, 104.27
- with and without hinged cover (except size 57.27)
- bulkhead or surface mounting
- recommended in case of vibrations or heavy weight of cables

- **CZ7 series: stainless steel locking lever, rigid**

- sizes 49.16, 66.16
- with and without hinged cover
- bulkhead or surface mounting
- recommended in case of vibrations or heavy weight of cables.

✓ IP66/IP69, IP66/IP67/IP69 degrees of protection according to model.

**Characteristics of materials for C7, CZ7 series**

- Made of die cast aluminium alloy;
- with epoxy-polyester thermosetting powder coating;
- gaskets in anti-aging, oil-resistant, grease-resistant and fuel-resistant vinyl nitrile elastomer;
- locking device integrally in stainless steel;
- ambient temperature range: -40 °C / +125 °C.

**IP68**



For applications in the railway sector and whenever the following characteristics are demanded: high pressure, impact and corrosion resistance, with degree of protection IP68. They also guarantee a good shielding for electromagnetic compatibility.

**Functional characteristics**

- The IP66/IP68/IP69 degree of protection is ensured if the enclosures are correctly installed and the cable entry devices have equal or higher rating.
- ✓ UL certified for USA and Canada for Type 4, 4X (outdoor use) and Type 12 (indoor use) ratings, marked on the packaging.  
IP69 degree of protection for tightness to pressurized water jets.

**Characteristics of materials for CG and MG series**

- Made of die cast aluminium alloy;
- with thermosetting epoxy powder coating;
- locking device with either screws or bayonets (types with suffix B).

**180 °C**

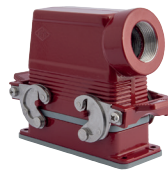

Series specifically developed for industrial applications where the ambient temperatures are particularly harsh (from -40 °C to +180 °C).

**Functional characteristics**

- For use with inserts in self-extinguishing thermoplastic material suitable for high temperatures (>PPS< polyphenylene sulphide);
- this version is distinguished by the red colour of the enclosures.
- ✓ UL certified for USA and Canada for Type 4, 4X (outdoor use) and Type 12 (indoor use) ratings, marked on the packaging.  
IP65/IP69 degree of protection.

**Characteristics of materials for CK..R, CZ..R, CH..R, CA..R and MK..R, MZ..R, MH..R, MA..R series**

- Made of die cast aluminium alloy;
- chromate treated die cast;
- coated with special thermosetting powder with high resistant to high temperatures;
- gaskets in anti-aging FKM fluoroelastomer;
- locking device with levers, springs and pins in stainless steel;
- single-block locking levers in stainless steel (for CZ..R, CH..R 48 and MZ..R, MH..R 48 versions);
- lever handles in die-cast aluminium with same special coating of enclosures (for CH..R 10, 16, 24 and MH..R 10, 16, 24 versions);
- supplementary insulation inside enclosures.

**E-Xtreme®**



ILME patented titanium plasma protection. Corrosion proof enclosures, resistant up to 3.000 hours in salt spray tests.

**Functional characteristics**

- Metal hoods and housings intended for extremely demanding environments, with special protective treatment under painting.  
Their special patented protective coating assures a high level of protection against the corrosion and erosion even in case of long-term exposure to salt mist;
- corrosion-proof aluminium with a special coating under the thermosetting powder coating colour RAL 7016 dark grey;
- FKM gasket (-40 °C...+180 °C) or silicone gasket (-60 °C...+180 °C);
- V-TYPE lever or C-TYPE lever, hoods with moulded pegs or riveted stainless steel bolts;
- durable protection against damage caused by stone chip, icing, salt mist, UV radiations and harsh gases
- ✓ IP65, IP66/IP69, IP66/IP67/IP69, IP66/IP68/IP69 (CG-MG) degrees of protection according to EN IEC 60529 (in mated and locked condition), according to model.

**Characteristics of materials for E-Xtreme® series**

- Material: aluminium die-cast
- Painting: thermosetting epoxy powder coating
- Colour: RAL 7016 (dark grey)
- Locking lever, springs and pegs: stainless steel
- Lever handle: C-Type polyamide; V-Type stainless steel
- Gasket: FKM
- Silicone-based compounds: free (except version for -60 °C... +180 °C)
- EN ISO 9227: 3.000 hours (V-Type lever and hood with moulded pegs); 2.000 hours (C-Type lever and hood with riveted stainless steel bolts)



**BIG**

The large dimensions of these innovative enclosures series have been chosen to offer customers an adequate space to store conductors.

**Functional characteristics**

- The width of the new enclosures is greater than that of previous versions: 66 mm compared to the 43 mm for standard enclosures.
- The height of BIG enclosures has also been increased to 100 mm for sizes "44.27" and "57.27" (standard versions for high models: 70 and 72 mm), and to 110 mm for sizes "77.27" and "104.27" (standard versions for high models: 76 mm).
- The cable compartment is now fully accessible during assembly (the connector insert is fully inserted in the lower half of the enclosure), offering three times the space compared to standard enclosures. This means it is possible to bend cables and pipes with greater bending radii.

Due to this important feature, the BIG enclosures are particularly suitable for MIXO modular inserts, being versatile and customizable, for multiple cable entries. Each insert, differentiated according to electric power or signal, pneumatic, optical fibre or Ethernet network current, may thus have the specific branching. One single large connector can replace what previously required two connectors.

✓ IP66/IP69 degree of protection.

**Characteristics of materials for CB and MB series**

- Made of die cast aluminium alloy;
- with epoxy-polyester thermosetting powder coating;
- die cast integral pegs.

**EMC**

This series has been developed for industrial applications that require electromagnetic compatibility (EMC, Electromagnetic Compatibility) in accordance with the European standards that regulate the emission and immunity of the equipment.

**Functional characteristics**

- For use with inserts in self-extinguishing thermoplastic material (PPS polyphenylene sulphide).
- ✓ UL certified for USA and Canada for NEMA 4, NEMA 4X and NEMA 12 degrees of protection (enclosure type ratings) printed on the packaging. IP65/IP69 or IP66/IP69 degree of protection according to model.

**Characteristics of materials for CK..S and MK..S series**

- Chromate coating treatment, RoHS 2 conform of die casts with high surface conductivity;
- special gaskets in highly conductive material;
- single-block locking lever in stainless steel.

**for CZ..S, CH..S, CA..S and MZ..S, MH..S, MA..S series**

- Made of die cast aluminium alloy;
- chromate conversion coating treatment of die cast, RoHS 2 conform, with high surface conductivity;
- special gaskets in highly conductive material;
- locking device with levers, springs and pins in stainless steel;
- lever handles in self-extinguishing thermoplastic material reinforced with glass fibres, UL approved.

**W-TYPE**

This series has been developed for industrial applications with particularly aggressive external agents (e.g. salt atmospheres or environments).

**Functional characteristics**

- The enclosures do not have any internal tabs (with polarization function) thus they allow also the insertion of the CME inserts;
- enclosures have supplementary insulating strips inside for use with CME 830 V inserts;
- the inserts of CME series connectors (screw-type) have a lateral key coding that prevents installation in metal housings without such additional insulation.
- this version is distinguished by the black colour of the enclosures
- ✓ UL certified for USA and Canada for NEMA 4, NEMA 4X and NEMA 12 degrees of protection (enclosure type ratings) printed on the packaging. IP65/IP69 or IP66/IP69 degree of protection according to model.

**Characteristics of materials for CK..W and MK..W series**

- Chromate treated die cast;
- with epoxy thermosetting powder coating;
- gaskets in anti-aging FKM fluoroelastomer;
- single-block locking device in stainless steel

**CZ..W, CH..W, CA..W series and MZ..W, MH..W, MA..W series**

- Made of die cast aluminium alloy;
- Chromate conversion coating, RoHS 2 conform treatment of die casts;
- with epoxy thermosetting powder coating;
- gaskets in anti-aging FKM fluoroelastomer;
- locking device with levers, springs and pins in stainless steel;
- pegs with stainless steel coating;
- single-block lever handles in stainless steel (for CZ..W and MZ..W enclosures);
- lever handles in self-extinguishing thermoplastic material reinforced with glass fibres, UL approved (CH..W, CA..W and MH..W, MA..W versions);
- supplementary insulation inside enclosures

**HYGIENIC**



The Hygienic multipole connector enclosures version (series T-TYPE/H and T-TYPE/C) has been designed for installation on food industry machines and systems.

**Functional characteristics**

- The following improvements to the T-TYPE series have been made in order to satisfy the requirements laid down by chapter 2.1 of Machinery Directive 2006/42/EC for the machines on which they are installed:
- material cleanliness and resistance to the cleaning and sanitising agents normally used in the food industry;
- materials in terms of the requirements for accidental contact with food products.

**Q** As the characterizing elements of the Hygienic Series are the different sealing gasket material and the different locking lever, hoods and covers without sealing gaskets and locking levers are the same of series T-TYPE Standard.

**Characteristics of materials for T-TYPE/H series**

- Enclosures in thermoplastic material, dark grey RAL 7012 colour, with high thicknesses providing structural solidity and durability.
- Sealing gaskets made by HNBR rubber formulated in accordance with FDA Guideline 21 CFR §177.2600.
- Locking levers in thermoplastic material, blue RAL 5015 colour.
- M25, M32 and M40 threaded cable entries.
- IP65/IP69 degree of protection according to EN 60529.
- Each enclosure carries its own part number, thread/size and conformity markings.
- Ambient temperature range: -40 °C / +70 °C.

**T-TYPE/C series**

- The Hygienic T-TYPE/C Series enclosures have been specifically designed for food and beverage ambient temperature as low as -50 °C (range: -50 °C / +70 °C);
- enclosures in thermoplastic material, dark grey RAL 7012 colour, with high thicknesses providing structural solidity and durability;
- T-TYPE/C differs from T-TYPE/H for the sealing gaskets made by in accordance with FDA Guideline 21 CFR §177.2600;
- ILME T-TYPE/C series enclosure materials have been selected according to EU n. 10/2011 regulation requirements and each component has been tested according to EU regulation n. 10/2011 and EC regulation n. 1935/2004.

**LS-TYPE**



Series specifically developed for industrial applications where the ambient temperatures are particularly harsh (from -40 °C to +180 °C).

**Functional characteristics**

- For use with inserts in self-extinguishing thermoplastic material (PPS polyphenylene sulphide).
- ✓ UL certified for USA and Canada for NEMA 4, NEMA 4X and NEMA 12 degrees of protection (enclosure type ratings) printed on the packaging. IP65/IP69 degree of protection.

**Characteristics of materials for CK..R, CZ..R, CH..R, CA..R and MK..R, MZ..R, MH..R, MA..R series**

- Made of die cast aluminium alloy;
- chromate conversion coating, RoHS 2 conform treatment of die cast;
- coated with special thermosetting powder coating with high resistant to high temperatures;
- gaskets in anti-aging FKM fluoroelastomer;
- locking device with levers, springs and pins in stainless steel;
- single-block locking levers in stainless steel (for CZ..R, CH..R 48 and MZ..R, MH..R 48 versions);
- lever handles in aluminium with special die-cast coating (for CH..R 10, 16, 24 and MH..R 10, 16, 24 versions);
- supplementary insulation inside enclosures.

**HNM**



Connector enclosures designed to endure high number of matings, to be used in combination with HNM connector inserts and relevant HNM removable crimp contacts, extending the guaranteed number of matings up to 10 000.

**Functional characteristics**

- HNM Housing (bulkhead or surface mounting) equipped with ILME proprietary design V-Type locking lever, further improved with special treatment to reduce the wear due to friction at minimum.
- HNM Hoods equipped with riveted rolling pegs and special anti-friction lubrication treatment.
- Ensuring long life span in those applications where frequent connections and disconnections are expected exceeding the standard 500 mating cycles.

**Characteristics of materials for RV, RH, RF, RAC HNM series**

- Made of die cast aluminium alloy;
- coated with thermosetting powder coating, epoxy-polyester;
- gaskets in anti-aging, oil resistant, grease resistant and fuel resistant vinyl nitrite elastomer;
- V-Type single locking lever, stainless steel;
- ambient temperature range -40 °C / +125 °C

## CENTRAL LEVER



Series specifically designed for industrial applications with limited installation space.

### Functional characteristics

- These enclosures can be installed, placed side-by-side and handled in a single operation. Furthermore, the lever's shape reduces the effort required to uncouple the inner fittings.

✔ IP65 degree of protection.

### Characteristics of materials

for CH..YC, CA..YC and MA..YC, CA..YX and MF..YX series

- Made of die cast aluminium alloy;
- with epoxy-polyester thermosetting powder coating;
- gaskets in anti-aging, oil-resistant, grease-resistant and fuel-resistant NBR vinyl nitrile elastomer;
- locking device with single stainless steel lever;
- stainless steel locking pegs with rollers, to reduce wear.

## MIXO ONE

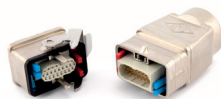

MIXO ONE is the aluminium housings system designed by ILME to accept the wide range of MIXO series single-sized modules.

### Functional characteristics

- These robust connector enclosures (3 hood variants and 1 bulkhead mounting housing) transform each single MIXO module into a completely independent connector;
- the enclosures allow mounting of single MIXO module only in one guided way, to avoid incorrect match with the mating connector;
- the enclosures incorporate a pre-leading (first-make, last-break) PE connection terminal and contact, for the safest connector operation;
- the pins protruding from the bulkhead mounting housing act also as key guide, in cooperation with the corresponding keyway sockets in the hoods, to avoid incorrect 180° reversed mating with corresponding connector;
- the rigid locking lever is releasably mounted on moulded pegs that include a stopping teeth;
- the hoods are split in two parts (front, rear), to allow MIXO module mounting and simplify the enclosure's PE connection. Supplied with four self-threading screws and self-retaining sealing gasket;
- the bulkhead mounting housing is supplied with the module locking frame and self-retaining flange gasket;
- four optional coding pins available;
- protection covers for hoods and housings available.

✔ cURus Type 4/4X/12 pending  
IP65 degree of protection

### Characteristics of materials

for CXA 01..., MXA 01... series

- Die cast aluminium alloy, nickel plated;
- gaskets in anti-aging, oil resistant, grease resistant and fuel resistant NBR vinyl nitrile elastomer;
- locking device with stainless steel single lever;
- module locking frame in stainless steel;
- self-threading assembly screws in stainless steel;
- optional coding pins CR CX... in self-extinguishing thermoplastic insulating material (UL 94V-0).

### For CXP 01... covers

- Shock-proof self-extinguishing thermoplastic material (UL 94 V-0) suitable for outdoor exposure, either with pegs (for enclosures with locking lever and sealing gasket) or with locking lever and sealing gasket (for enclosures with pegs) both with eyelet-terminated string (for fastening to housings) or with loop-terminated cord (for fastening to hoods, around the incoming cable);
- locking device – if any – made by the same material of the cover.

## CK-CKA-MKA

### CQ



Thermoplastic and metallic enclosures size "21.21" for standard or aggressive environments and insulated version size "32.13"

### Functional characteristics

- For use with all size "21.21" connector inserts;
- Connector inserts for use at SELV are prevented to be installed in metallic enclosures CKA-MKA, CGK-MGK (as they would not provide protective earth connection for the enclosure) thanks to a special key and keyway system in all "21.21" metallic enclosure. Insulating "21.21" enclosures accept all "21.21" inserts.
- CGK-MGK IP68 enclosures (actually IP66/IP68/IP69) available both with 2-screw locking or by 2-bayonet locking (types with suffix B).

✔ UL certified for USA and Canada for Type 4, 4X and 12 degrees of protection (enclosure type ratings, equivalent to NEMA rating), printed on the packaging.

**IP44** degree of protection, IP66/IP67/IP69 by using the special fixing screw + gasket kit CKR 65(D) separately available, and suitable cable outlet device.

**IP66/IP68/IP69** degree of protection for CGK-MGK enclosures equipped with **CKR 65(D)** kit.

### Characteristics of materials

for CK, MK and CQ series

- In self-extinguishing grey RAL 7035 or black thermoplastic material for insulating (CQ series only available black) or metallic enclosures;
- metal enclosures in die cast zinc or aluminium alloy, according to model;
- metal enclosures with epoxy-polyester thermosetting powder coating;
- gaskets in anti-aging, oil-resistant, grease-resistant and fuel-resistant NBR vinyl nitrile elastomer;
- metallic enclosures with single-block locking lever in stainless or galvanised steel;
- insulating enclosures with single-block locking lever in self-extinguishing thermoplastic material.

# ENCLOSURES FEATURES

Series	Version	Material	Size	Size ID	Cable entry		Locking device
CK / MK	Standard	Insulating	21.21	03	M20 - 25	Pg 11	single
CKA / MKA	Standard W (Ambienti aggressivi) S (EMC) E (E-Xtreme®)	Metallic	21.21	03	M20 - 25	Pg 11	single
CKAX / MKAX							
CKG / MKG	Standard	Insulating	21.21	03	M20 - 25	Pg 11	single
CKAG / MKAG		Metallic			M20		
IP68 (CGK / MGK)	IP68	Metallic	21.21	03	M20 - 25	Pg 13,5	screw / bayonet
CQ / MQ	Standard	Insulating	32.13	08	M25x2	Pg 16 - 21	single
	S (EMC)	Insulating metallized					
MIXO ONE (CXA, MXA)	EMC as standard	Metallic	—	—	M25 - 32	—	single
IL-BRID (CZ / MZ)	Standard	Metallic	49.16	15	M20 - 25	Pg 13,5 - 21	single
CZ7 / MZ7	Standard C-TYPE W (Aggressive environments) S (EMC) R (High temperatures) E (E-Xtreme®)		66.16	25		Pg 16 - 21	
C-TYPE (CH / CA / MH / MA)	Standard C-TYPE W (Aggressive environments) S (EMC) R (High temperatures) 830V (Insulated) E (E-Xtreme®)	Metallic	66.40	50	M25 - 29	Pg 21 - 29	dual
			44.27	06	M20 - 40	Pg 13,5 - 29	single
			55.27	10		Pg 16 - 29	dual
			77.27	16	M25 - 50	Pg 21 - 36	
			104.27	24			
			77.62	32	M32 - 50	Pg 29 - 42	single / dual
			104.62	48			single

**CM/MM enclosures for 830V screw type connector inserts CM series available only upon request (as well as the CM series inserts)**

(\*) 49.16 (15) and 66.15 (25) with adapter CR xx/16.

1) Enclosures ensure IP degree of protection when coupled and locked with the locking lever. The cover (CS, CP) only provides mechanical protection without ensuring the IP degree of protection.

2) Versions with plastic cover are not approved.

Series	IP (EN 60529) <sup>1)</sup>	UL 50 Type (NEMA 250 type)	Notes	Ambient temperature limit (°C)
CK / MK	IP44	12		-40 / +125
	IP66/IP67/IP69	12, 4, 4X	with CKR 65 (D)	
CKA / MKA	IP44/ IP66/IP67/IP69	12		-40 / +125
CKAX / MKAX	IP66/IP67/IP69	12, 4, 4X	with CKR 65 (D)	
CKG / MKG	IP66/IP67/IP69	12, 4, 4X	for CXL, CJK and CX 1/2 BD inserts	-40 / +125
CKAG / MKAG				
IP68 (CGK / MGK)	IP66/IP68/IP69	12, 4, 4X		-40 / +125
CQ / MQ	IP66/IP67/IP69	12, 4, 4X	with conductive gasket CR 08 EMC	-40 / +125
MIXO ONE (CXA, MXA)	IP65	12, 4, 4X	for single size MIXO modules	-40 / +125
IL-BRID (CZ / MZ)	IP66/IP69	12, 4, 4X	SIMPLEX with self-closing cover	-40 / +125 [R = -40 / +180]
CZ7 / MZ7	IP66/IP67/IP69			
C-TYPE (CH / CA / MH / MA)	IP44 IP66/IP69 [IP65]	12 12, 4, 4X <sup>2)</sup> [12, 4, 4X <sup>2)</sup> ]		-40 / +125 [R = -40 / +180]

Series	Version	Material	Size	Size ID	Cable entry		Locking device
<b>T-TYPE</b> (TCH / TH / TMA / TA)	Standard (RAL 7012 grey) W (Aggressive environments) HYGIENIC (H or C)	Insulating	44.27	06	M25 - 32	—	single
			57.27	10			dual
			77.27	16	M32 - 40		
			104.27	24			
<b>V-TYPE IP67</b> (C7I, C7P / M7P, ...)	IP67 stainless steel levers E (E-Xtreme®)	Metallic	44.27	06	M20 - 40	Pg 16 - 29	single
			57.27	10	M25 - 40	Pg 21 - 29	dual
			77.27	16			
			104.27	24			
<b>V-TYPE</b> (CVIL, CVP / MVP L, ...)	IP65/IP66 stainless steel levers	Metallic	44.27	06	M20 - 40	Pg 16 - 29	single
			57.27	10	M25 - 40	Pg 21 - 29	
			77.27	16			
			104.27	24			
<b>BIG</b> (CB / MB)	Standard W (Aggressive environments) E (E-Xtreme®)	Metallic	44.27	06	M20 - 50	—	single
			57.27	10			dual
			77.27	16			
			104.27	24			
<b>IP68</b> (CG / MG)	Standard (inherently EMC) E (E-Xtreme®)	Metallic	44.27	06	M25 - 32	Pg 16 - 29	Screw or bayonet
			57.27	10	M32 - 50	Pg 21 - 29	
			77.27	16			
			104.27	24			
<b>Central lever</b> (...YX / ...YC)	Standard	Metallic	44.27	06	M25 - 32	Pg 16 - 29	single central lever
			57.27	10			
			77.27	16	M32 - 40	Pg 21 - 29	
			104.27	24			
<b>COB</b>	Standard	Insulating	44.27	06	—	—	dual
			57.27	10			
			77.27	16 (*)			
			104.27	24			
<b>LS-TYPE</b> (CHIN, CHPN / MHPN, ...)	Light and sound applications (Black colour)	Metallic Thermoplastic lever	44.27	06	M20 - 40	Pg 16 - 29	single
			57.27	10			dual
			77.27	16	M25 - 40	Pg 21 - 29	
			104.27	24			

**CM/MM enclosures for 830V screw type connector inserts CM series available only upon request  
(as well as the CM series inserts)**





- <sup>1)</sup> Enclosures ensure IP degree of protection when coupled and locked with the locking lever. The cover (CS, CP) only provides mechanical protection without ensuring the IP degree of protection.
- <sup>2)</sup> Versions with plastic cover are not approved.

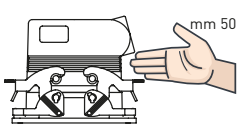

Series	IP (EN 60529) <sup>1)</sup>	UL 50 Type (NEMA 250 type)	Notes	Ambient temperature limit (°C)
T-TYPE (TCH / TH / TMA / TA)	IP65/IP69 IP66/IP69 IP65/IP69	12 (Standard version only)		-40 / +90 STD -40 / +90 W -40 / +70 (T-TYPE/H) -50 / +70 (T-TYPE/C)
V-TYPE IP67 (C7I, C7P / M7P, ...)	IP67/IP76/IP69	12, 4, 4X <sup>2)</sup>		-40 / +125
V-TYPE (CVIL, CVP / MVP L, ...)	IP65 IP66/IP69	12, 4, 4X <sup>2)</sup>	SIMPLEX with self-closing cover	-40 / +125
BIG (CB / MB)	IP66/IP69	12, 4, 4X		-40 / +125
IP68 (CG / MG)	IP66/IP68/IP69	12, 4, 4X		-40 / +125
Central lever (...YX / ...YC)	IP65	12, 4, 4X		-40 / +125
COB	IP20			-40 / +125
LS-TYPE (CHIN, CHPN / MHPN, ...)	IP65	12, 4, 4X <sup>2)</sup>		-40 / +125

# THE DEGREE OF PROTECTION

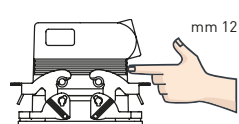
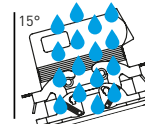
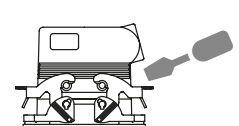
The connector's housing, sealing and locking mechanism protect the connection from external influences such as mechanical shocks, foreign bodies, humidity, dust, water or other fluids such as cleansing and cooling agents, oils, etc. The degree of protection the housing offers is explained in the IEC 60 529, DIN EN 60 529, standards that categorize enclosures according to foreign body and water protection. The following table shows the **IP (Ingress Protection) Ratings Guide**.

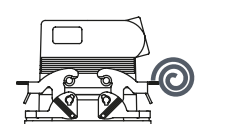
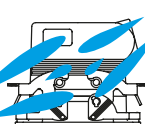
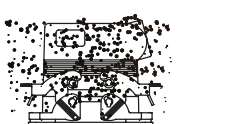
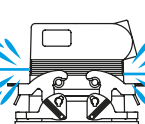
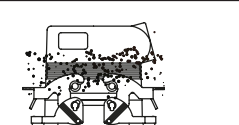
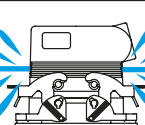
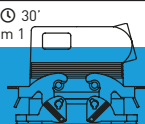
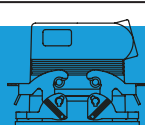
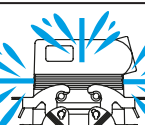
FIRST Index figure	Degree of protection SOLIDS		SECOND Index figure	Degree of protection WATER	
0		No protection	0		No protection
1		Protected against access to hazardous parts with the back of a hand and protected against solid foreign objects of Ø 50 mm and greater	1		Protected against vertically falling water drops
2		Protected against access to hazardous parts with a finger - protected against solid foreign objects of Ø 12,5 mm and greater	2		Protected against vertically falling water drops when enclosure tilted up to 15° (on either side of the vertical)
3		Protected against access to hazardous parts with a tool - protected against solid foreign objects of Ø 2,5 mm and greater	3		Protected against spraying water (at an angle up to 60° on either side of the vertical)
4		Protected against access to hazardous parts with a wire - protected against solid foreign objects of Ø 1,0 mm and greater	4		Protected against splashing water from any direction
5		Protected against access to hazardous parts with a wire dust-protected (no harmful dust deposit)	5		Protected against water jets from any direction
6		Protected against access to hazardous parts with a wire dust-tight (total protection against dust)	6		Protected against powerful water jets from any direction (similar to sea waves)
			7		Protected against the effects of temporary immersion in water at a maximum depth of 1 meter for 30 min
			8		Protected against the effects of continuous immersion in water at depth and/or duration upon agreement, more severe than for numeral 7
			9*		Protected against high pressure and temperature water jets from any direction

RATING EXAMPLE

**IP 6 5**

Description according to IEC 60529  
 \* ... IP69K is not part of IEC 60529

## CHANGEOVER FROM PG THREADS TO METRIC

After 31<sup>st</sup> December 1999, the German safety standard DIN VDE 0619 (1987-09) and the standards it refers to - DIN 46319 for dimensions with metric threads and DIN 46320 (T1-T4), DIN 46255 and DIN 46259 for dimensions with Pg threads (Pg= Panzerrohr-Gewinde: literally "threads for armoured pipes") - were withdrawn and European standard EN 50262 "Metric cable grippers for electrical installations" has been in force since 1st January 2000.

This standard defines the new sizes with metric threads for cable grippers according to EN 60423 and establishes the safety prescriptions.

Conversely, it does not specify the dimensions, such as the size of the tightening wrench, the diagonal dimension, or the dimensions of the tightness seals, as was the case in the withdrawn DIN for Pg cable grippers.

The standard came definitively into force on 1<sup>st</sup> April 2001, when the contrasting national standards were withdrawn.

It is valid in all member countries of CENELEC (European Electrical Standardisation Committee) and its publication has led to a broadening of the supply of enclosures for multi-pole connectors for industrial use, to include new enclosure versions with cable entry suitable for metric cable grippers.

Cable gripper producers have introduced the new metric series to add to the Pg size series, to gradually replace the latter type. The transition period indicated in the new standard should have ended on 1<sup>st</sup> March 2001, after which date the use of entry devices for Pg cables and, as a result, enclosures with Pg thread, should have ended in new installations. Nevertheless, both the cable entry devices and the relevant enclosures with Pg thread, may continue to be used as spare parts. For the CE marking of these items, observance of the safety conditions specified by the Low Voltage Directive is sufficient.

- ✍ **To distinguish hoods and surface-mounting housings with metric entries from the relevant Pg versions (marked with a C pre-code), the ILME metric types are marked with an M pre-code. The transposition table below indicates the correspondence rule adopted in most cases by ILME for creating the new metric versions.**

### Pg → metric transposition table

Pg	Metric
Pg 11	M 20
Pg 13.5	M 20
Pg 16	M 20
Pg 21	M 25
Pg 29	M 32
Pg 36	M 40
Pg 42	M 50

### Cable diameter for use with ILME cable glands

Ø in mm	Metric thread				
	20	25	32	40	50
<b>AS M..P</b>	6-12,5	10-18	14-24	15-24	23-30
<b>AS M..E</b>	8-12,5	13,5 - 18	17-24	—	—
<b>AG M..T</b>	6 - 8 -10	11 - 14 - 17	19 - 21 -24	26 - 29 - 32	35-38-41
<b>AG M..I</b>	5-12,5	9-18	14-25	18-32	24-38,5
<b>AG M..R</b>	6 - 8 -10	11 - 14 - 17	19 - 21 - 24	—	—

For more information, please refer to the technical catalogue on [www.ilme.com](http://www.ilme.com)

# COMBINATIONS BETWEEN ENCLOSURES AND INSERTS

## Identification of enclosures

Connector inserts and their enclosures are numerous and therefore the search for the correct pairing of one with another may be complex.

To facilitate this operation (in addition to the normal part number) the definition of “**size**” has been introduced in this catalogue.

As indicated in the illustration on the left and in the table below, the size value refers to the “**x - y**” **fixing screw centre distance** which constitute a unique and shared element, since they are common to both the inserts and the enclosures.

The following table shows all the sizes of the enclosures and the dimensions of the housings where the inserts will be fastened.

Enclosures size	Insert housing with x - y fixing screw centre distance
21.21	(21 x 21 mm) **
32.13	32 x 13 mm
49.16	49,5 x 16 mm
66.16	66 x 16 mm
66.40	66 x 16 mm (2 inserts)
44.27	44 x 27 mm
57.27	57 x 27 mm
77.27	77,5 x 27 mm
104.27	104 x 27 mm
77.62	77,5 x 27 mm (2 inserts)
104.62	104 x 27 mm (2 inserts)

\*\* Dimensions relating to the insert cross-section size, not being able to identify a fixing screw centre distance, since all “21.21” sized inserts are provided with a single fixing screw.

 All pages that illustrate combinable articles (inserts and enclosures) carry references as per the examples illustrated on the opposite page.

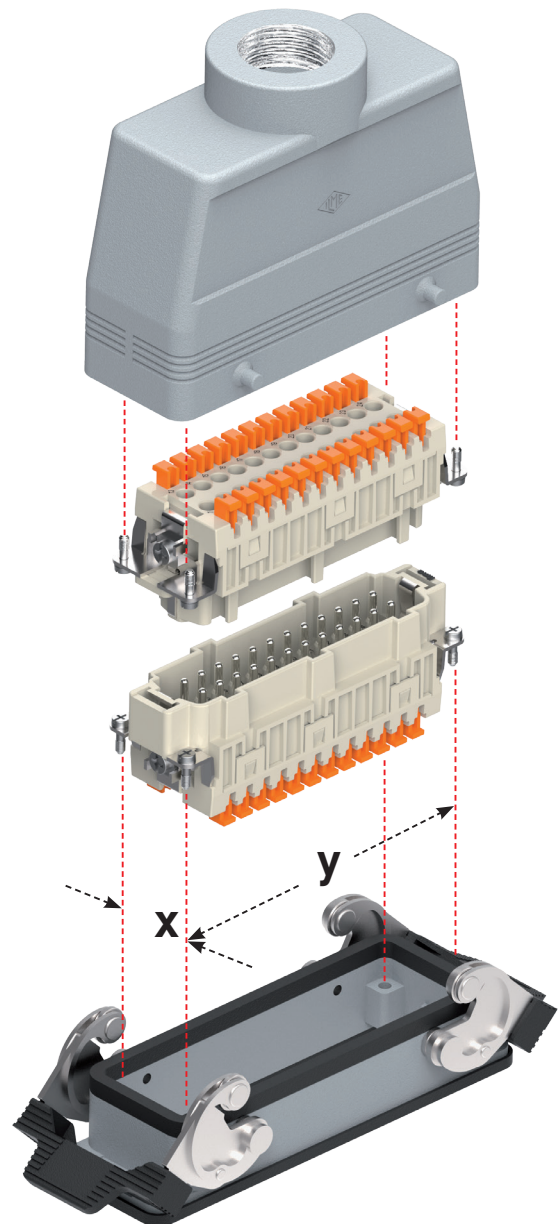

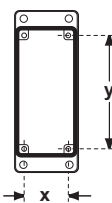
Enclosures size  x • y  	Rated current																			
	6A	10A	10A	10A	10A	10A	16A	16A	16A	16A	16A	16A	16A	35A	40A 16A 10A 6,5A	16A 10A	100A 40A 10A	80A 16A	200A 100A 70A 40A 16A 10A 5A 4A	
	Inserts Series																			
	CDSH NC	CK - CKS ▲ CKSH	CD - RD (HNM)	CT - CTS	CDD - RDD (HNM)	CDS ▲ CDSH	CDA - CDC - CSAH	CCE - RCE (HNM)	CNE	CSE ▲ CSS - CSH	CT - CTS - CTSE	CME ▲	CMSE ▲ CMSH - CMCE	CP	CQ - COE - CQEE RQEE (HNM)	CX	CX	CX	CX	MIXO
Inserts polarity + ⊕																				
21.21		3 4	7 8 ⌘												2 3 5 7 12 21					
32.13															7 8 4/2					
49.16			15			10													1*	
66.16			25		38	16														
66.40			50		76	32														
44.27	6				24 (HNM)	9		6 (HNM)	6	6	6 ■				10				2*	
55.27					42 (HNM)	18		10 (HNM)	10	10	10 ■	3 <sup>+2</sup>	3 <sup>+2</sup>		18	8/24			3*	
77.27			40 (HNM)	40 ■	72 (HNM)	27		16 (HNM)	16	16	16 ■	6 <sup>+2</sup>	6 <sup>+2</sup>	6	32 40 (HNM)		6/12 6/36 12/2	4/0 4/2	4*	
104.27			64 (HNM)	64 ■	108 (HNM)	42		24 (HNM)	24	24	24 ■	10 <sup>+2</sup> 16 <sup>+2</sup> •	10 <sup>+2</sup>		46 64 (HNM)		6/6	4/8	6*	
77.62			80		144	54		32	32	32	32 ■	12 <sup>+4</sup>	12 <sup>+4</sup>	12	64				8*	
104.62			128		216	84		48	48	48	48 ■	20 <sup>+4</sup> 32 <sup>+4</sup> •	20 <sup>+4</sup> 32 <sup>+4</sup>		92				12*	

**Legend**

- ⌘ Polarity without earth ⊕ contact.
- Can only be mounted in bulkhead housings (6/10/16/24 polarity, also usable with BIG series hoods).
- Polarity not available in CMSH version.
- \* Number of modular inserts that may be inserted in the enclosures.

Polarity values in **LIGHT GREY background** are obtained using double inserts.

Polarity values in **LIGHT BLUE background** must be mounted exclusively in insulated enclosures (CM - CMA and MM - MMA versions) or T-TYPE series.

Polarity values indicated as exponentials in the CME, CMSH - CMCE inserts identify the pilot contacts for advanced opening.

▲ Available upon request

# ACCESSORIES AND TOOLS FOR INSERTS AND ENCLOSURES

## SUPPORTS AND ADAPTORS

Provide the solution to the most various installation needs. The extensive range of articles comprises: panel supports for inserts, special enclosures (housing with double outlet, wide housings, housings without outlets, to be punched out, housings for round cables, hoods), insert combination blocks, accessories for CT inserts, interface for printed circuits, kits for control equipment, plates for mounting D-Sub inserts onto enclosures, reducing plates and closure plates, protection lid for transportation, coding pins.



## TOOLS

To guarantee the efficiency and safety of the connections a complete series of specific tools are available for contact crimping that assure the maximum quality required by the standards. Manual or pneumatic or electric (battery operated) semi-automatic tools for light production or automatic electro-pneumatic tools for large-scale production are available, together with a complete series of complimentary tools for mounting and dismounting of the crimped contacts.





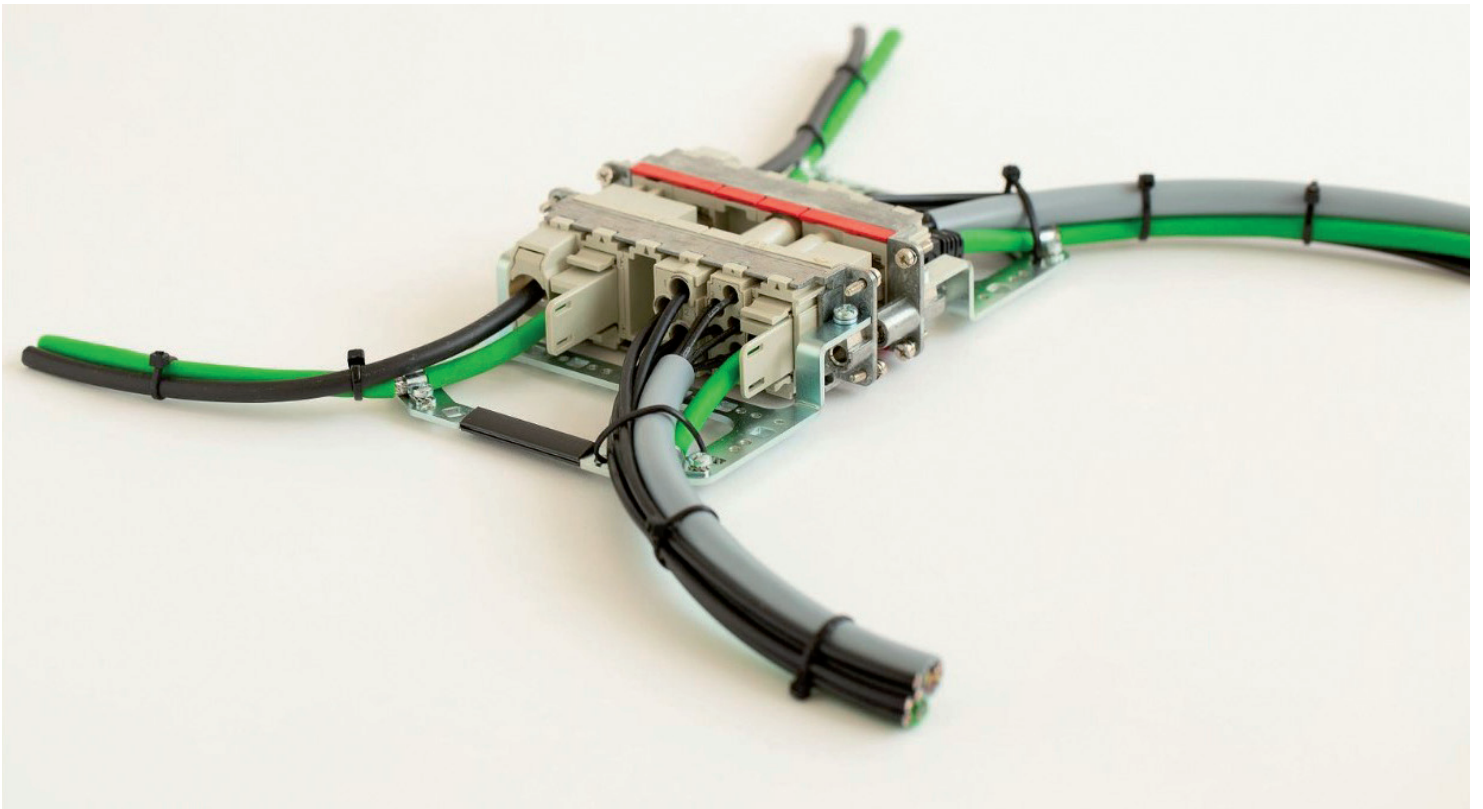

# INSERTS



## CK - CKD - CK...RY - CKSH-SQUICH®

- Screw terminal  
10A - 230/400V
- Without tools (SQUICH®)  
10A - 400V

From page..... 58

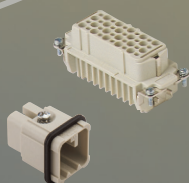

## CD

- Crimp  
10A - 250V
- Crimp (CD 8 poles)  
10A - 50V ac/120V dc

From page..... 66

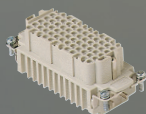

## CDD

- Crimp  
10A - 250V

From page..... 76

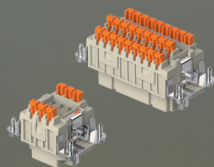

## CDSH-SQUICH® - CDSH NC-SQUICH®

- Without tools  
10A - 400V  
6A - 250V

From page..... 86

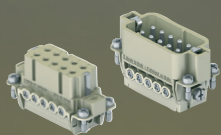

## CDA

- Screw terminal  
16A - 250V

From page..... 98

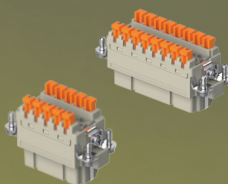

## CSAH-SQUICH®

- Without tools  
16A - 250V

From page..... 99

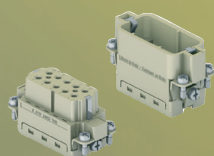
**CDC**

- Crimp  
16A - 250V

From page..... 104

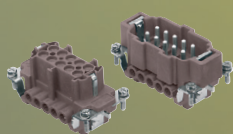
**CNE - CNE...RY**

- Screw terminal  
16A - 500V

From page..... 110

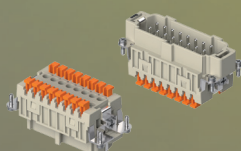
**CSH-SQUICH®**

- Without tools  
16A - 500V

From page..... 110, 116

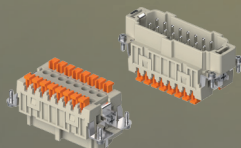
**CSH S-SQUICH®**

- Without tools  
16A - 500V

From page..... 122

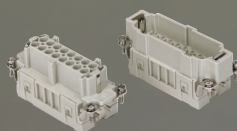
**CCE**

- Crimp  
16A - 500V

From page..... 130

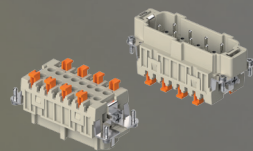
**CMSH-SQUICH® - CMCE**

- Screw terminal  
16A - 830V
- Without tools (SQUICH®)  
16A - 830V

From page..... 136

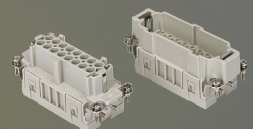

- Crimp  
16A - 830V

From page..... 137



**CSS**

- Dual spring  
16A - 500V

From page..... 148

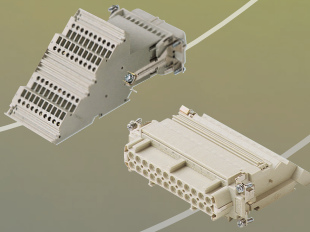

**CT - CTS - CTSE**

- Screw terminal  
10A - 250V  
16A - 400V

From page..... 156, 160

- Spring  
10A - 250V  
16A - 500V

From page..... 156, 160

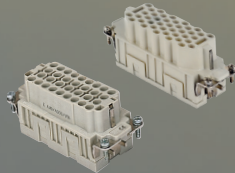

**CQE - CQEE**

- Crimp  
16A - 500V

From page..... 168, 176

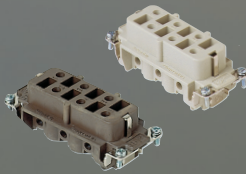

**CP - CP...RY**

- Screw terminal  
35A - 400/690V

From page..... 178



**CQ**

- Crimp  
6,5A/10A/16A/40A

From page..... 182

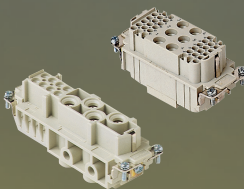

**CX COMBINED INSERTS**

- Crimp  
10A/16A/40A/100A

From page..... 194

- Screw terminal  
16A/80A

From page..... 200



**HNM**

- RD - RDD  
Crimp  
10A - 250V

From page..... 208

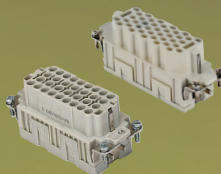

- RCE - RQEE  
Crimp  
16A - 500V

From page..... 214



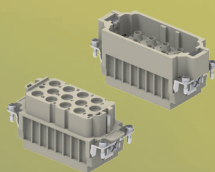

- RX  
Crimp  
12 poles (40A-690V) + 2 poles (10A-250V + PE)  
From page..... 221

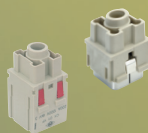

- MIXO**  
•Crimp  
4A/5A/10A/16A/40A/70A/100A/200A  
From page..... 232



- Screw terminal  
40A  
From page..... 238



- Spring  
16A  
From page..... 243

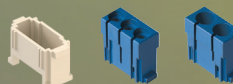

- Dummy module - Pneumatic contacts  
From page..... 282



- Frames  
From page..... 286

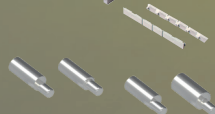

- PE terminal adapters for MIXO frames  
From page..... 289



- MIXO DATA**  
•Gigabit - BUS - USB - D-SUB  
•POF/MOST - Coaxial - Optic - RJ45  
From page..... 256

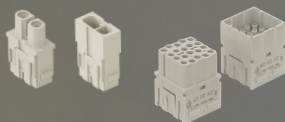

- MIXO HNM**  
•Crimp  
10A/16A/40A  
•HNM frames  
From page..... 291

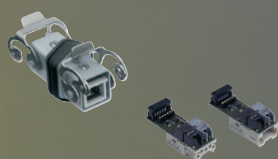
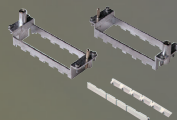

- DATA CONNECTORS**  
From page..... 305

**DESINA**

- From page..... 326





# CK series with optional coding pins: avoid incorrect connections

The renewed CK series of inserts addresses the need for connector coding with the addition of coding pins CR K03, CR K04R and CR K04G.

Each connector is made to make coupling of inserts from different series impossible, by suitable key and key way. Inserts are also polarized against inadvertent 180° mating. When a number of identical connectors with different functions are mounted close together, the coupling of a free part onto a non-corresponding fixed part must be prevented in order to avoid possible damage and breakdown.

The coding pins added to the renewed CK series **allow the user to safely configure the male and female inserts** to prevent the incorrect connection of identical connectors.

With various combinations of coding pins available, it is possible to safely install up to 4 connectors of the same type but with different functions side-by-side.

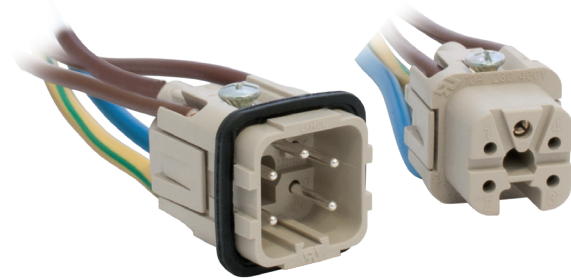

### SUM UP

- ☑ Connection up to 2,5 mm<sup>2</sup>
- ☑ New RAL 7032 colour
- ☑ Bult-in silver or gold plated contacts

### CR K03 version, for connectors 3P + ⊕

Inserting the pin in the 4 possible positions by rotating through 90° allows 4 different insert codings to be obtained.

### CR K04 version, for connectors 4P + ⊕

**2 pin versions available: yellow - red**  
Each pin has 2 possible specular insertion positions. Alternate use of the pins allows 4 coding combinations to be achieved.

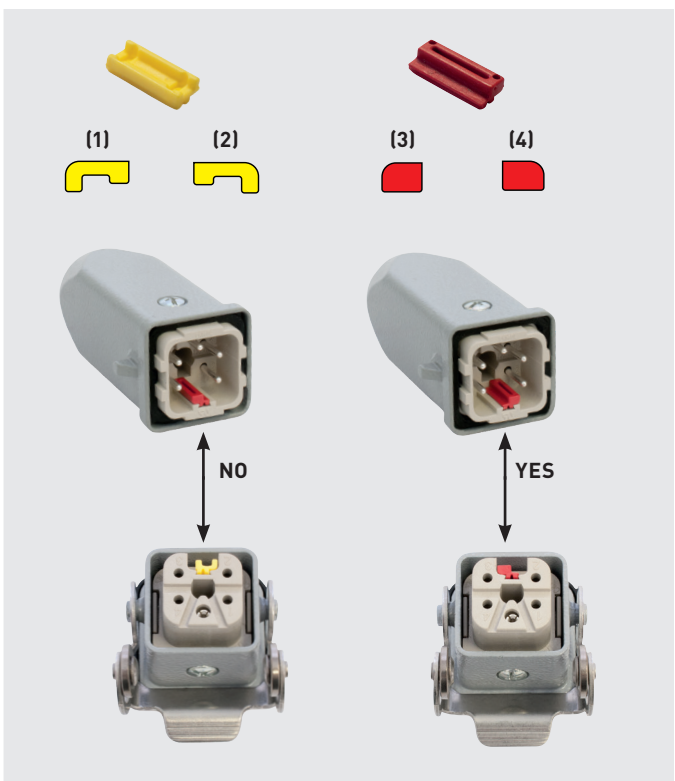
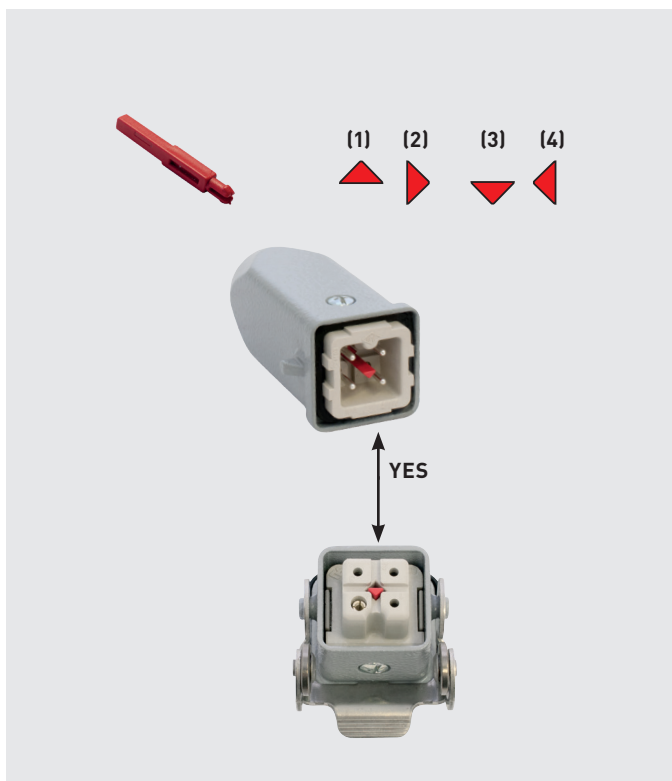

# CK 3 and 4 poles + ⊕ 10A - 230/400V

enclosures:  
size "21.21"

page:

Insulating type	339 - 348
Metallic type	349 - 363
W-TYPE for aggressive environments	512 - 518
E-Xtreme® corrosion proof	538 - 539
EMC	564 - 572
IP68	628 - 631

- can be mated with CKSH inserts

## inserts, 3 poles + ⊕ screw terminal connections



### Q SILVER PLATED CONTACTS

## inserts, 4 poles + ⊕ screw terminal connections



### Q SILVER PLATED CONTACTS

description	part No.	part No.	part No.	part No.
distinctive colour	white	black	white	black
female inserts with female contacts <sup>1)</sup>	<b>CKF 03</b>	<b>CKF 03 N</b>	<b>CKF 04</b>	<b>CKF 04 N</b>
male inserts with male contacts	<b>CKM 03</b>	<b>CKM 03 N</b>	<b>CKM 04</b>	<b>CKM 04 N</b>
distinctive colour				
female inserts with female contacts <sup>1)</sup>				
male inserts with male contacts				

1) the female inserts can be mounted into the straight bulkhead housings CK I from the rear

- characteristics according to EN 61984:

**10A 230/400V 4kV 3**  
**10A 400/690V 4kV 2**

- certified
- rated voltage according to UL/CSA: 600V
- insulation resistance:  $\geq 10$  G $\Omega$
- ambient temperature limit: -40 °C ... +100 °C
- made of self-extinguishing thermoplastic resin UL 94V-1
- mechanical life:  $\geq 500$  cycles
- contact resistance:  $\leq 1$  m $\Omega$
- for max. current load see the connector inserts derating diagrams below; for more information see page 28

#### CK 03 poles connector inserts Maximum current load derating diagram

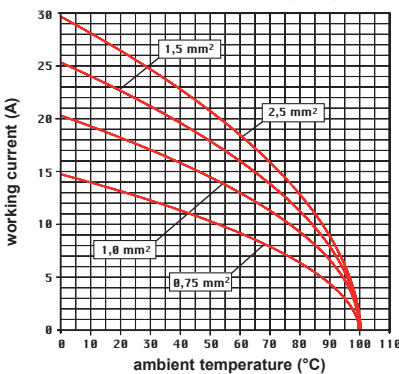

#### CK 04 poles connector inserts Maximum current load derating diagram

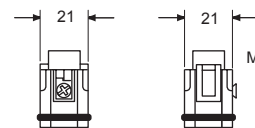
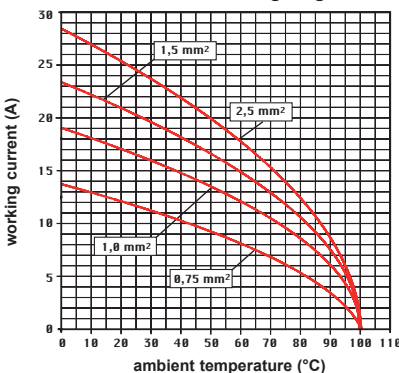

contacts side (front view)

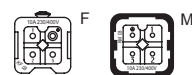

- inserts for wires with the following cross-sectional areas:  
0,75 - 2,5 mm<sup>2</sup> - AWG 18 - 14
- conductor stripping length: 6 mm
- terminal screw torque: 0,5 Nm (4.4 lb.in), for more information see page 20 and 21

CR K03  
coding pins  
(page 688)

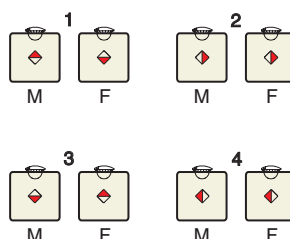

M = male insert  
F = female insert

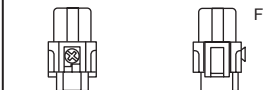
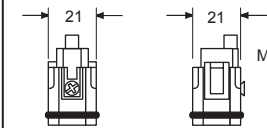

contacts side (front view)

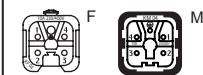

- inserts for wires with the following cross-sectional areas:  
0,75 - 2,5 mm<sup>2</sup> - AWG 18 - 14
- conductor stripping length: 6 mm
- terminal screw torque: 0,5 Nm (4.4 lb.in), for more information see page 20 and 21

CR K04R  
and CR K04G coding  
pins (page 692)

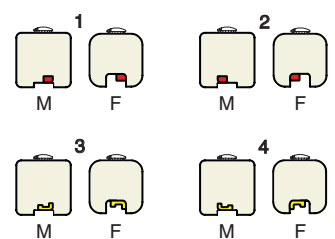

M = male insert  
F = female insert

CK

# CKD 3 and 4 poles + ⊕ 10A - 230/400V

enclosures: size "21.21"	page:
Insulating type	339 - 348
Metallic type	349 - 363
W-TYPE for aggressive environments	512 - 518
E-Xtreme® corrosion proof	538 - 539
EMC	564 - 572
IP68	628 - 631

## inserts, 3 poles + ⊕ screw terminal connections



### Q GOLD PLATED CONTACTS

## inserts, 4 poles + ⊕ screw terminal connections



### Q GOLD PLATED CONTACTS

description	part No.	part No.
female inserts with female contacts <sup>1)</sup> male inserts with male contacts	<b>CKFD 03</b> <b>CKMD 03</b>	<b>CKFD 04</b> <b>CKMD 04</b>
female inserts with female contacts <sup>1)</sup> male inserts with male contacts		

1) the female inserts can be mounted into the straight bulkhead housings CK I from the rear

- characteristics according to EN 61984:  
**10A 230/400V 4kV 3**  
**10A 400/690V 4kV 2**
- certified
- rated voltage according to UL/CSA: 600V
- insulation resistance: ≥ 10 GΩ
- ambient temperature limit: -40 °C ... +100 °C
- made of self-extinguishing thermoplastic resin UL 94V-1
- mechanical life: ≥ 500 cycles
- contact resistance: ≤ 1 mΩ
- for max. current load see the connector inserts derating diagrams below; for more information see page 28

**CKD 03 poles connector inserts**  
Maximum current load derating diagram

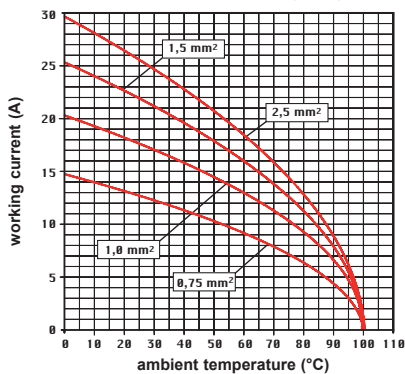

**CKD 04 poles connector inserts**  
Maximum current load derating diagram

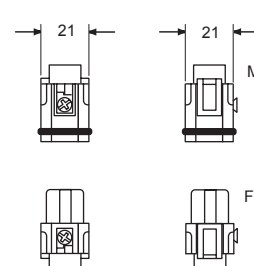
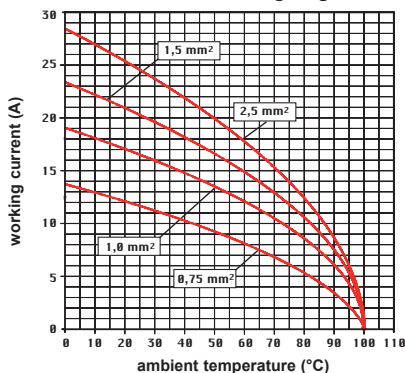

contacts side (front view)

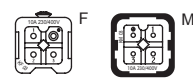

- inserts for wires with the following cross-sectional areas:  
0,75 - 2,5 mm<sup>2</sup> - AWG 18 - 14
- conductor stripping length: 6 mm
- terminal screw torque: 0,5 Nm (4.4 lb.in), for more information see page 20 and 21

**CR K03**  
coding pins  
(page 688)

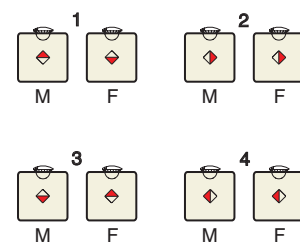

M = male insert  
F = female insert

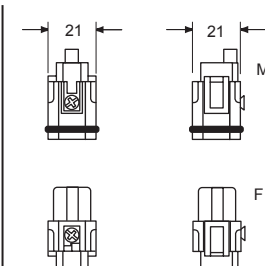

contacts side (front view)



- inserts for wires with the following cross-sectional areas:  
0,75 - 2,5 mm<sup>2</sup> - AWG 18 - 14
- conductor stripping length: 6 mm
- terminal screw torque: 0,5 Nm (4.4 lb.in), for more information see page 20 and 21

**CR K04R**  
and **CR K04G** coding pins  
(page 692)

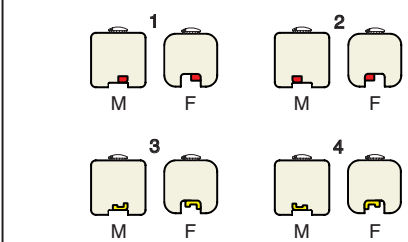

M = male insert  
F = female insert

# CK...RY 3 and 4 poles + ⊕ 10A - 230/400V

enclosures:  
size "21.21"

page:

For 180 °C

583 - 586

inserts, 3 poles + ⊕  
screw terminal connections

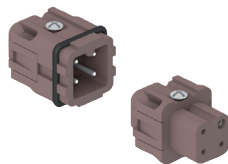

✍ 180 °C

Q SILVER PLATED CONTACTS

inserts, 4 poles + ⊕  
screw terminal connections

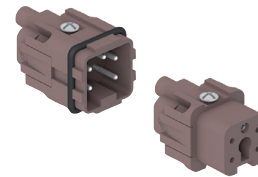

✍ 180 °C

Q SILVER PLATED CONTACTS

description

part No.

part No.

use at temperatures up to 180 °C  
female inserts with female contacts <sup>1)</sup>, brown  
male inserts with male contacts, brown

CKF 03 RY  
CKM 03 RY

use at temperatures up to 180 °C  
female inserts with female contacts <sup>1)</sup>, brown  
male inserts with male contacts, brown

CKF 04 RY  
CKM 04 RY

1) the female inserts can be mounted into the straight bulkhead housings CK I from the rear

- characteristics according to EN 61984:

**10A 230/400V 4kV 3**  
**10A 400/690V 4kV 2**

- certified

- rated voltage according to UL/CSA: 600V
- insulation resistance: ≥ 10 GΩ
- ambient temperature limit: -40 °C ... +180 °C
- made of self-extinguishing thermoplastic resin UL 94V-0
- mechanical life: ≥ 500 cycles
- contact resistance: ≤ 1 mΩ
- for max. current load see the connector inserts derating diagrams below; for more information see page 28

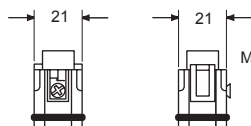

contacts side (front view)

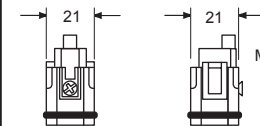
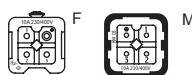

contacts side (front view)



CK...RY 03 poles connector inserts  
Maximum current load derating diagram

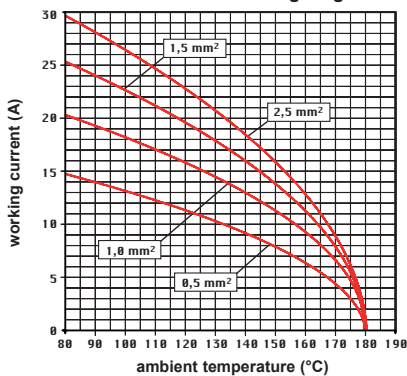

CK...RY 04 poles connector inserts  
Maximum current load derating diagram

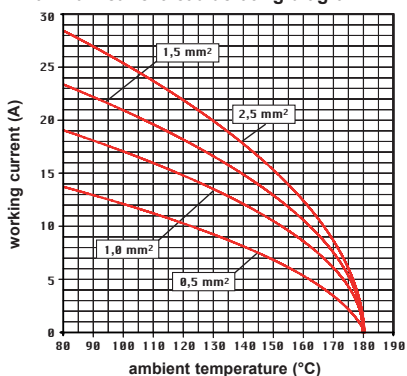

- inserts for wires with the following cross-sectional areas:  
0,75 - 2,5 mm<sup>2</sup> - AWG 18 - 14
- conductor stripping length: 6 mm
- terminal screw torque: 0,5 Nm (4.4 lb.in), for more information see page 20 and 21

- inserts for wires with the following cross-sectional areas:  
0,75 - 2,5 mm<sup>2</sup> - AWG 18 - 14
- conductor stripping length: 6 mm
- terminal screw torque: 0,5 Nm (4.4 lb.in), for more information see page 20 and 21

# CKSH-SQUICH® series

## Easy wiring in a compact space

These small but very capable connector inserts sized “21.21” are the evolution of former patented CKS series, still available upon request: thanks to a further step ahead in ILME proprietary solutions, they implement the fast, tool-less and skill-independent SQUICH® technology even in such a narrow space.

Reliable spring clamp contacts are now faster to wire thanks to the presence – also on the protective earth terminal – of the actuator pushbuttons, whose colour coding provides further visual help in identifying their function. Each pushbutton safely allows the insertion of a measuring probe even upon connector wired and under load, and is featured with a side slot for the possible spring terminal re-opening, by using a simple 0,5x3 mm flat blade screwdriver.

The conductor entries are on the top rear of the connector insert, as in former CKS inserts, providing **vertical straight terminations**, whereas screw-type CK inserts have lateral conductor entries and terminal screws on the top rear. CKSH connector inserts are available in the traditional two polarities: 3P+ ⊕ and 4P+ ⊕, for applications with rated voltage up to 400V AC or DC and continuous rated current per pole up to 10A.

These connector inserts inherit the proprietary optional coding system introduced in the recently renewed series CK and CKS, to prevent mismatching in case of multiple connectors installed close to each other. This coding system does not alter the mating face, so connectors not making use of it are fully backwards mating compatible with former products. They are fully interchangeable, with even improved performances, to the legacy much appreciated screw-type series CK (230/400V) and CKS (spring terminals), which they replace.



### SUM UP

- ☑ Easy wiring in compact size
- ☑ All the advantages of ILME SQUICH® connection in size 21.21
- ☑ Vertical and straight termination
- ☑ Full 400V voltage rating compared to 230/400V of series CK
- ☑ Built-in silver plated contacts

Requiring no wiring tool and no special wire preparation, they provide **excellent conductor fastening** with great resistance to strong vibrations.

Connecting capacity of terminals is from 0,14 mm<sup>2</sup> to 2,5 mm<sup>2</sup> (26 to 14 AWG) for unprepared conductors. Use of prepared conductors (terminated with crimped ferrule) is up to 1,5 mm<sup>2</sup> /16 AWG, suitable to rated current up to 10A per pole, due to the relatively limited number of poles.



no need of wiring tools



already open terminals



reduced wiring time



quick identification of wired terminals

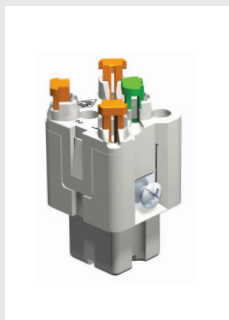

☑ Easy wiring in compact size



☑ With coding pins

☑ Rear top entry for easier wiring

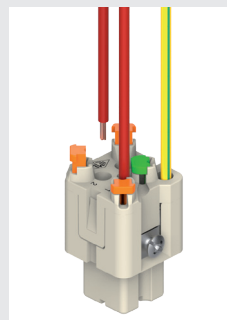

☑ For solid or flexible wires and for crimped ferrules

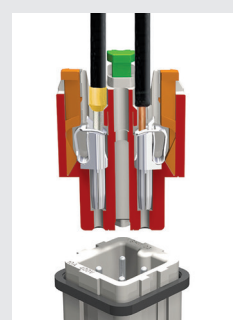

# CKSH-SQUICH® series

## TECHNICAL FEATURES

Insert series		CKSH-SQUICH®
No. of poles	Main contacts	3, 4
	auxiliary contacts	—
Rated current <sup>1)</sup>		10A
EN IEC 61984	rated voltage	400V
	rated impulse withstand voltage	4kV
	<b>pollution degree</b>	<b>3</b>
EN IEC 61984	rated voltage	690V
	rated impulse withstand voltage	4kV
	<b>pollution degree</b>	<b>2</b>
UL / CSA certification	rated voltage (a.c./d.c.)	600V
Contact resistance		≤ 3 mΩ
Insulation resistance		≥ 10 GΩ
Ambient temperature limit (°C)	min	-40
	max	70
Degree of protection	with enclosures (according to type)	<b>IP44</b> , IP66/ <b>IP67</b> /IP69, IP66/ <b>IP68</b> /IP69, IP66/ <b>IP68</b> /IP69 (according to type and model)
	without enclosures - termination side on male and female inserts - mating side on female inserts	<b>IP20</b> (IPXXB)
Conductor connections		spring type with actuator button
Conductor cross-sectional area	mm <sup>2</sup>	0,14 - 2,5 unprepared
		0,14 - 1,5 prepared with crimped ferrule
	AWG	26 - 14 unprepared
		26 - 16 prepared with crimped ferrule
Mechanical endurance (mating cycles)		≥ 500

1) Please check the inserts derating diagrams to establish the actual maximum operating current according to the ambient temperature, the conductor cross-sectional area, the polarity of the connector, and any external constraint may derive e.g. by the continuous operating temperature sustained by the chosen conductor sheathing or by end-product safety standards fixing max allowed temperature rise on terminals (e.g. 30 K, 45 K or 50 K)



# CKSH-SQUICH® 3 and 4 poles + ⊕ 10A - 400V SQUICH®

enclosures: size "21.21"	page:
Insulating type	339 - 348
Metallic type	349 - 363
W-TYPE for aggressive environments	512 - 518
E-Xtreme® corrosion proof	538 - 539
EMC	564 - 572
IP68	628 - 631

- can be mated with CK inserts

## inserts, 3 poles + ⊕ spring terminal connection without tools

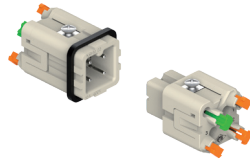

## inserts, 4 poles + ⊕ spring terminal connection without tools

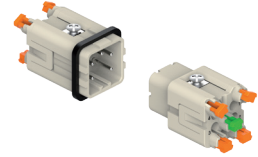

description	part No.	part No.
female inserts with female contacts	<b>CKSHF 03</b>	<b>CKSHF 04</b>
male inserts with male contacts	<b>CKSHM 03</b>	<b>CKSHM 04</b>
female inserts with female contacts		
male inserts with male contacts		

- characteristics according to EN 61984:  
**10A 400V 4kV 3**  
**10A 690V 4kV 2**
- certified
- insulation resistance:  $\geq 10 \text{ G}\Omega$
- ambient temperature limits:  $-40 \text{ }^\circ\text{C} \dots +125 \text{ }^\circ\text{C}$
- made of self-extinguishing thermoplastic resin UL 94V-0
- mechanical life:  $\geq 500$  cycles
- contact resistance:  $\leq 1 \text{ m}\Omega$
- for max. current load see the connector inserts derating diagrams below; for more information see page 28

**CKSH 03 poles connector inserts**  
Maximum current load derating diagram

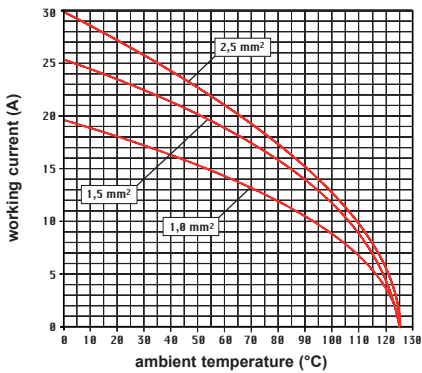

**CKSH 04 poles connector inserts**  
Maximum current load derating diagram

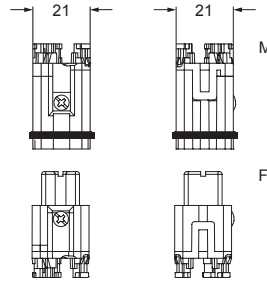
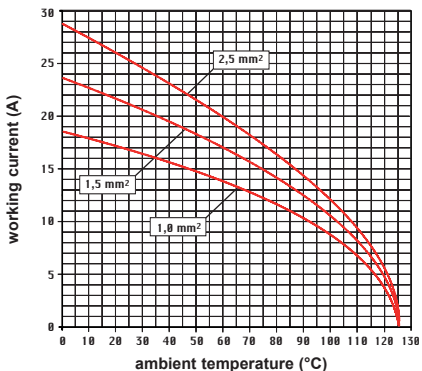

contacts side (front view)

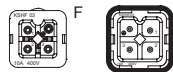

- inserts for wires with the following cross-sectional areas: 0,14 - 2,5 mm<sup>2</sup> - AWG 26 - 14 for prepared wires useable section: up to 1,5 mm<sup>2</sup> (AWG 16)
- conductor stripping length: 9...11 mm

**CR K03**  
coding pins  
(page 688)



### SQUICH®-spring connection technology WIRING

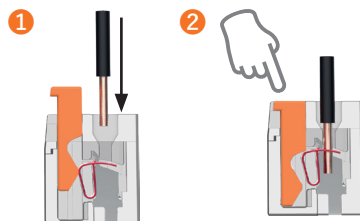

1 Deeply insert a stripped conductor into a round terminal.

2 Push the actuator button to close the terminal.

### RE-OPENING

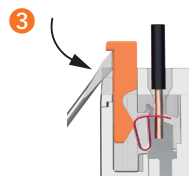

3 Insert a 0,5 x 3,5 mm flat blade screwdriver in the actuator button side window and pull it up by levering down.

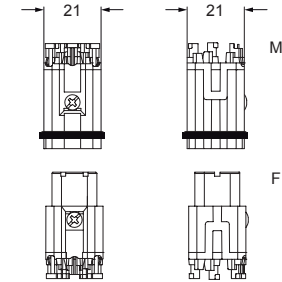

contacts side (front view)

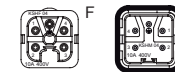

- inserts for wires with the following cross-sectional areas: 0,14 - 2,5 mm<sup>2</sup> - AWG 26 - 14 for prepared wires useable section: up to 1,5 mm<sup>2</sup> (AWG 16)
- conductor stripping length: 9...11 mm

**CR K04R**  
and **CR K04G** coding pins  
(page 681)



### Rear top entry of wires for a more easier wiring

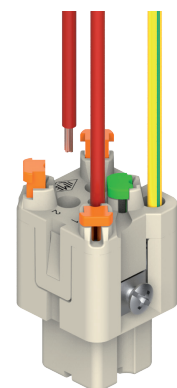

## CD - CDD series

### CD series

It is a multipole connector series for crimped connections made with removable crimp contacts **CD** series.

There are 5 different sizes available (6 polarities):

- "21.21" with two inserts, respectively **CD 07** (7 P + ⊕) and **CD 08** (8 P) for SELV applications;

**NOTE** – These two polarities are coded to avoid their incorrect cross-mating. **CD 07**, being equipped with a pass-through PE connection that does not serve as equipotential bonding of a metal enclosure, is suitably safely-coded to avoid mismatch with a metal enclosure of this size.

- "49.16" with **CD 15** (15 P + ⊕) provided by 3 rows of 5 contact seats each;
- "66.16" with **CD 25** (25 P + ⊕) provided by 2 outer rows of 9 contact seats each and 1 inner row with 7 contact seats;
- "77.27" with **CD 40** (40 P + ⊕) provided by 4 rows of 10 contact seats each;
- "104.27" with **CD 64** (64 P + ⊕) provided by 4 rows of 16 contact seats each.

It is also possible to mount **two inserts side-by-side in a connector enclosure** is also given:

- for inserts size "66.16" (**CD 25 + CD 25 Z**) to get a **50 P + ⊕** connector with connector enclosures size "66.40";
- for inserts size "77.27" (**CD 40 + CD 40**) to get an **80 P + ⊕** connector with connector enclosures size "77.62";
- for inserts size "104.27" (**CD 64 + CD 64**) to get a **128 P + ⊕** connector with connector enclosures size "104.62".

The last four sizes of the first list are described in **EN 175 301-801:2006** European standard, which derives from the old German standard **DIN 43 652**, whose first edition dates back to the Seventies of last century. This standard provides dimensional standardization for these four sizes of connector inserts as well as for **CD series crimp contacts**, solid, machined, used by these connectors, and of the main types (and sizes) of relevant **connector enclosures**, including interface dimensions between the connector inserts and the relevant connector hood or housing, overall dimensions of locking levers and pegs, etc. This standard provides ground for the dimensional standardization of the other connector sizes (e.g. "44.27", "57.27") for all series of connector inserts with the same size and for all connector enclosure series with these sizes.

As for any series of connector inserts for crimped connections, the polarity is to be intended as "up to", being always possible to fit a connector insert with a reduced number of crimped connections, suiting the specific application. In this regard, see e.g. next page for use of **CD** series connector inserts at special (higher) voltages.

These connectors cover applications for rated voltage up to **250V AC/DC in pollution degree 3** (industrial environment) when connectors are fully equipped with contacts, and for rated currents up to **10A** per pole (derating diagram show actual current carrying capacity as a function of number of poles, conductor size and ambient temperature).

The PE connection for size "21.21" **CD 07** is a pass-through (crimp) connection that does not provide equipotential bonding to earth to a possible metal connector enclosure, hence the safety coding implemented in inserts **CDM 07** and **CDF 07** to avoid mismatch with metal enclosures.

The PE connection for the other sizes is provided by a screw terminal on the side of pole #1, and by lateral mating contacts. The PE terminal of the inserts provide earthing to the metal enclosures.

### CDD series

It is the high density evolution of **CD** series. It provides choice of **5 different sizes** (5 polarities) of multipole connector inserts for crimped connections made with removable crimp contacts **CD** series:

- "44.27" with **CDD 24** (24 P + ⊕) provided by 6 rows of 4 contact seats each;
- "66.16" with **CDD 38** (38 P + ⊕) provided by 2 outer rows of 10 contact seats each and 2 inner rows with 9 contact seats each;
- "57.27" with **CDD 42** (42 P + ⊕) provided by 6 rows of 7 contact seats each;
- "77.27" with **CD 72** (40 P + ⊕) provided by 6 rows of 12 contact seats each;
- "104.27" with **CDD 108** (64 P + ⊕) provided by 6 rows of 18 contact seats each.

It is also possible to mount two inserts side-by-side in a connector enclosure is also provided:

- for inserts size "66.16" (**CDD 38 + CDD 38**) to get a **76 P + ⊕** connector with connector enclosures size "66.40";
- for inserts size "77.27" (**CD 72 + CDD 72**) to get a **144 P + ⊕** connector with connector enclosures size "77.62";
- for inserts size "104.27" (**CDD 108 + CDD 108**) to get a **216 P + ⊕** connector with connector enclosures size "104.62".

These connectors cover applications for rated voltage up to **250 VAC/DC in pollution degree 2** (suitable for industrial environment once used inside enclosures >IP54) when connectors are fully equipped with contacts, and for rated currents up to 10A per pole (derating diagram show actual current carrying capacity as a function of number of poles, conductor size and ambient temperature).

The PE connection for all sizes is provided by a screw terminal on the side of pole #1, and lateral mating contacts. The PE terminal of the inserts provide earthing to the metal enclosures.

Even when the coding function is not required, **it is highly recommended to use CRM and CRF coding pins** (see pages 685, 686 in this catalogue) **with CD and CDD connector inserts**, to reduce movements when mating and unmating the connectors, to avoid contact damage. To this aim, standard EN 175 301-801:2006 specifies a max allowed angular longitudinal fluctuation of ± 5%.

# Special voltages for CD series

If all the contacts are used, CD connector inserts may be used with voltage up to 250V (first column) pollution degree 3 in accordance with standard EN 61984.

If the number of contacts is reduced and the contacts assigned accordingly, these connectors may be used at higher voltages. This is possible because the decrease in the number of contacts

leads to an increase in clearances (insulating distances in air) and creepage distances (insulating distances along the surface).

When the contacts are arranged as shown below, the inserts may be used at rated voltage of 500V (second column) pollution degree 3 in accordance with standard EN 61984.

**For use up to 250V  
pollution degree 3**  
diagrams  
contacts side (front view)

**CD 07 - 7 + ⊕**



**CD 15 - 15 + ⊕**

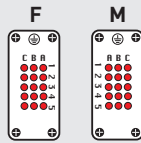

**CD 25 - 25 + ⊕**

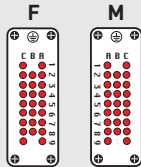

**CD 40 - 40 + ⊕**

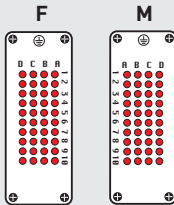

**CD 64 - 64 + ⊕**

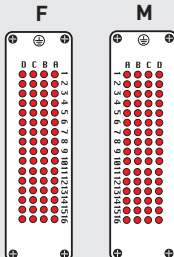

**Legend:**

- working contact
- without contact
- M = male insert
- F = female insert

**For use up to 500V  
pollution degree 3**  
diagrams  
contacts side (front view)

**CD 07 - 3 + ⊕**

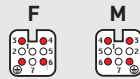

**CD 15 - 7 + ⊕**

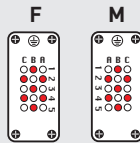

**CD 25 - 11 + ⊕**

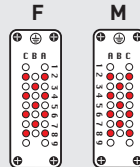

**CD 40 - 20 + ⊕**

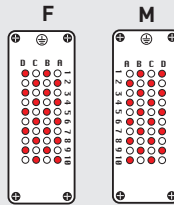

**CD 64 - 32 + ⊕**

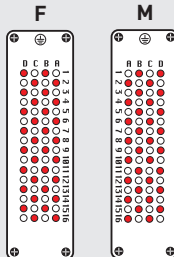

# CD 7 poles + ⊕ 10A - 250V

enclosures:  
size "21.21"

page:

Insulating type

339 - 348

## inserts, crimp connections

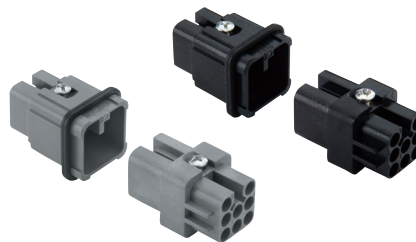

## 10A crimp contacts silver and gold plated



description	part No.	part No.	part No.	part No.
without contacts (to be ordered separately)	grey	black		
female inserts for female contacts, grey and black <sup>1)</sup>	<b>CDF 07</b>	<b>CDM 07 N</b>		
male inserts for male contacts, grey and black	<b>CDM 07</b>	<b>CDM 07 N</b>		
10A female contacts				
0,14-0,37 mm <sup>2</sup> AWG 26-22 identification No. 1			<b>CDFA 0.3</b>	<b>CDFD 0.3</b>
0,5 mm <sup>2</sup> AWG 20 identification No. 2			<b>CDFA 0.5</b>	<b>CDFD 0.5</b>
0,75 mm <sup>2</sup> AWG 18 identification No. ②			<b>CDFA 0.7</b>	<b>CDFD 0.7</b>
1 mm <sup>2</sup> AWG 18 identification No. 3			<b>CDFA 1.0</b>	<b>CDFD 1.0</b>
1,5 mm <sup>2</sup> AWG 16 identification No. 4			<b>CDFA 1.5</b>	<b>CDFD 1.5</b>
2,5 mm <sup>2</sup> AWG 14 identification No. 5			<b>CDFA 2.5</b>	<b>CDFD 2.5</b>
10A male contacts				
0,14-0,37 mm <sup>2</sup> AWG 26-22 identification No. 1			<b>CDMA 0.3</b>	<b>CDMD 0.3</b>
0,5 mm <sup>2</sup> AWG 20 identification No. 2			<b>CDMA 0.5</b>	<b>CDMD 0.5</b>
0,75 mm <sup>2</sup> AWG 18 identification No. ②			<b>CDMA 0.7</b>	<b>CDMD 0.7</b>
1 mm <sup>2</sup> AWG 18 identification No. 3			<b>CDMA 1.0</b>	<b>CDMD 1.0</b>
1,5 mm <sup>2</sup> AWG 16 identification No. 4			<b>CDMA 1.5</b>	<b>CDMD 1.5</b>
2,5 mm <sup>2</sup> AWG 14 identification No. 5			<b>CDMA 2.5</b>	<b>CDMD 2.5</b>

silver plated

gold plated+

1) the female inserts can be mounted into the straight bulkhead housings CK I from the rear

- characteristics according to EN 61984:

**10A 250V 4kV 3**  
**10A 230/400V 4kV 2**

- certified
- rated voltage according to UL/CSA: 600V
- insulation resistance: ≥ 10 GΩ
- ambient temperature limit: -40 °C ... +125 °C
- made of self-extinguishing thermoplastic resin UL 94V-0
- mechanical life: ≥ 500 cycles
- contact resistance: ≤ 3 mΩ
- for applications requiring higher voltages, please see the special voltage application section on page 65
- **it is recommended to crimp the contacts with crimping tools homologated by ILME** (please see the crimping tool section 10A contacts, CDF and CDM series on pages 705 - 741)
- for max. current load see the connector inserts derating diagram below; for more information see page 28

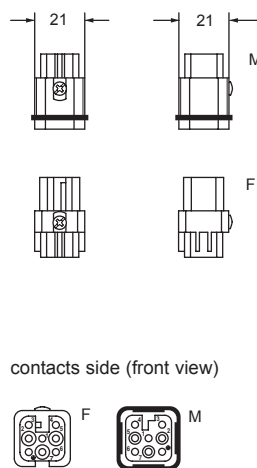

contacts side (front view)

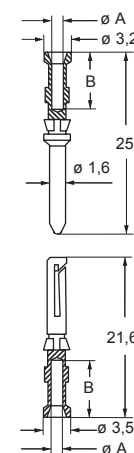

### CDF and CDM contacts

conductor section mm <sup>2</sup>	conductor slot ø A (mm)	conductors stripping length B (mm)
0,14-0,37	0,9	8
0,5	1,1	8
0,75	1,3	8
1,0	1,45	8
1,5	1,8	8
2,5	2,2	6

CD 07 poles connector inserts  
Maximum current load derating diagram

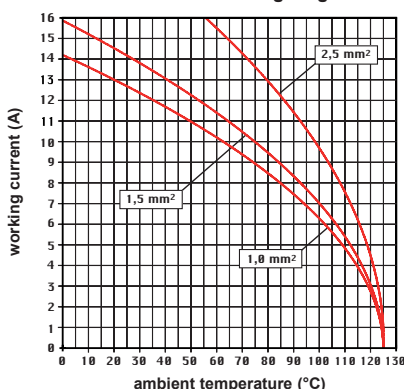

CR CP coding pin with loss of one contact (page 689)



+ for basic or high thickness gold plating, please refer to page 674

# CD 8 poles 10A - 50V ac / 120V dc

enclosures: size "21.21"	page:
Insulating type	339 - 348
Metallic type	349 - 363
W-TYPE for aggressive environments	512 - 518
E-Extreme® corrosion proof	538 - 539
EMC	564 - 572
IP68	628 - 631

## inserts, crimp connections

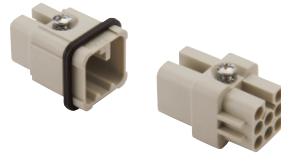

## 10A crimp contacts silver and gold plated



description	part No.	part No.	part No.
without contacts (to be ordered separately)			
female inserts for female contacts <sup>1)</sup>	<b>CDF 08</b>		
male inserts for male contacts	<b>CDM 08</b>		
<b>10A female contacts</b>			
0,14-0,37 mm <sup>2</sup> AWG 26-22 identification No. 1		<b>CDFA 0.3</b>	<b>CDFD 0.3</b>
0,5 mm <sup>2</sup> AWG 20 identification No. 2		<b>CDFA 0.5</b>	<b>CDFD 0.5</b>
0,75 mm <sup>2</sup> AWG 18 identification No. ②		<b>CDFA 0.7</b>	<b>CDFD 0.7</b>
1 mm <sup>2</sup> AWG 18 identification No. 3		<b>CDFA 1.0</b>	<b>CDFD 1.0</b>
1,5 mm <sup>2</sup> AWG 16 identification No. 4		<b>CDFA 1.5</b>	<b>CDFD 1.5</b>
2,5 mm <sup>2</sup> AWG 14 identification No. 5		<b>CDFA 2.5</b>	<b>CDFD 2.5</b>
<b>10A male contacts</b>			
0,14-0,37 mm <sup>2</sup> AWG 26-22 identification No. 1		<b>CDMA 0.3</b>	<b>CDMD 0.3</b>
0,5 mm <sup>2</sup> AWG 20 identification No. 2		<b>CDMA 0.5</b>	<b>CDMD 0.5</b>
0,75 mm <sup>2</sup> AWG 18 identification No. ②		<b>CDMA 0.7</b>	<b>CDMD 0.7</b>
1 mm <sup>2</sup> AWG 18 identification No. 3		<b>CDMA 1.0</b>	<b>CDMD 1.0</b>
1,5 mm <sup>2</sup> AWG 16 identification No. 4		<b>CDMA 1.5</b>	<b>CDMD 1.5</b>
2,5 mm <sup>2</sup> AWG 14 identification No. 5		<b>CDMA 2.5</b>	<b>CDMD 2.5</b>

1) the female inserts can be mounted into the straight bulkhead housings CK I from the rear

- characteristics according to EN 61984:  
**10A 50V ac / 120V dc 0,8kV 3**
- certified
- rated voltage according to UL/CSA: 50V ac / 120V dc
- insulation resistance: ≥ 10 GΩ
- ambient temperature limit: -40 °C ... +125 °C
- made of self-extinguishing thermoplastic resin UL 94V-0
- mechanical life: ≥ 500 cycles
- contact resistance: ≤ 3 mΩ
- for applications requiring higher voltages, please see the special voltage application section on page 65
- **it is recommended to crimp the contacts with crimping tools homologated by ILME** (please see the crimping tool section 10A contacts, CDF and CDM series on pages 705 - 741)
- for max. current load see the connector inserts derating diagram below; for more information see page 28

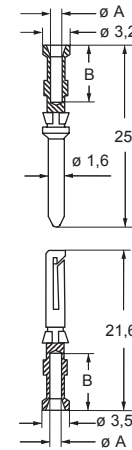
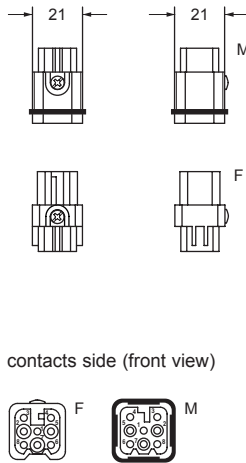

**CD 08 poles connector inserts**  
Maximum current load derating diagram

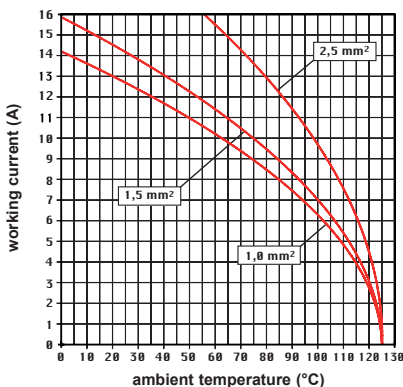

CR CP coding pin with loss of one contact (page 689)



### CDF and CDM contacts

conductor section mm <sup>2</sup>	conductor slot ø A (mm)	conductors stripping length B (mm)
0,14-0,37	0,9	8
0,5	1,1	8
0,75	1,3	8
1,0	1,45	8
1,5	1,8	8
2,5	2,2	6

<sup>+</sup> for basic or high thickness gold plating, please refer to page 674

# CD 15 poles + ⊕ 10A - 250V

enclosures: size "49.16"	page:
IL-BRID	374 - 377, 382
CZ7 IP67, single lever	384
W-TYPE for aggressive environments	519
E-Xtreme® corrosion proof	540
EMC	576

panel supports: COB + adaptor	page: 652 - 654
----------------------------------	--------------------

## inserts, crimp connections

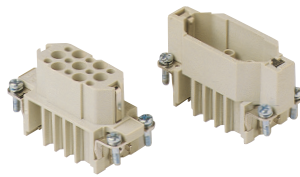

## 10A crimp contacts silver and gold plated



description	part No.	part No.	part No.
without contacts (to be ordered separately)			
female inserts for female contacts	<b>CD F 15</b>		
male inserts for male contacts	<b>CD M 15</b>		
<b>10A female contacts</b>			
0,14-0,37 mm <sup>2</sup> AWG 26-22 identification No. 1		<b>CDFA 0.3</b>	<b>CDFD 0.3</b>
0,5 mm <sup>2</sup> AWG 20 identification No. 2		<b>CDFA 0.5</b>	<b>CDFD 0.5</b>
0,75 mm <sup>2</sup> AWG 18 identification No. ②		<b>CDFA 0.7</b>	<b>CDFD 0.7</b>
1 mm <sup>2</sup> AWG 18 identification No. 3		<b>CDFA 1.0</b>	<b>CDFD 1.0</b>
1,5 mm <sup>2</sup> AWG 16 identification No. 4		<b>CDFA 1.5</b>	<b>CDFD 1.5</b>
2,5 mm <sup>2</sup> AWG 14 identification No. 5		<b>CDFA 2.5</b>	<b>CDFD 2.5</b>
<b>10A male contacts</b>			
0,14-0,37 mm <sup>2</sup> AWG 26-22 identification No. 1		<b>CDMA 0.3</b>	<b>CDMD 0.3</b>
0,5 mm <sup>2</sup> AWG 20 identification No. 2		<b>CDMA 0.5</b>	<b>CDMD 0.5</b>
0,75 mm <sup>2</sup> AWG 18 identification No. ②		<b>CDMA 0.7</b>	<b>CDMD 0.7</b>
1 mm <sup>2</sup> AWG 18 identification No. 3		<b>CDMA 1.0</b>	<b>CDMD 1.0</b>
1,5 mm <sup>2</sup> AWG 16 identification No. 4		<b>CDMA 1.5</b>	<b>CDMD 1.5</b>
2,5 mm <sup>2</sup> AWG 14 identification No. 5		<b>CDMA 2.5</b>	<b>CDMD 2.5</b>

- characteristics according to EN 61984:  
**10A 250V 4kV 3**  
**10A 230/400V 4kV 2**
- compliant with DIN EC 175-301-801 standard
- certified
- rated voltage according to UL/CSA: 600V
- insulation resistance: ≥ 10 GΩ
- ambient temperature limit: -40 °C ... +125 °C
- made of self-extinguishing thermoplastic resin UL 94V-0
- mechanical life: ≥ 500 cycles
- contact resistance: ≤ 3 mΩ
- for applications requiring higher voltages, please see the special voltage application section on page 65
- **it is recommended to crimp the contacts with crimping tools homologated by ILME** (please see the crimping tool section 10A contacts, CDF and CDM series on pages 705 - 741)
- for max. current load see the connector inserts derating diagram below; for more information see page 28

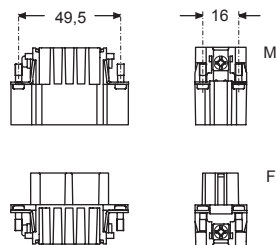

contacts side (front view)

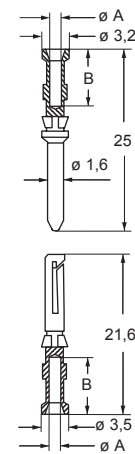
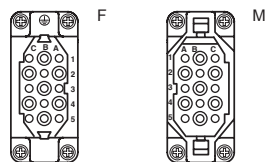

### CDF and CDM contacts

conductor section mm <sup>2</sup>	conductor slot ø A (mm)	conductors stripping length B (mm)
0,14-0,37	0,9	8
0,5	1,1	8
0,75	1,3	8
1,0	1,45	8
1,5	1,8	8
2,5	2,2	6

† for basic or high thickness gold plating, please refer to page 674

CD 15 poles connector inserts  
Maximum current load derating diagram

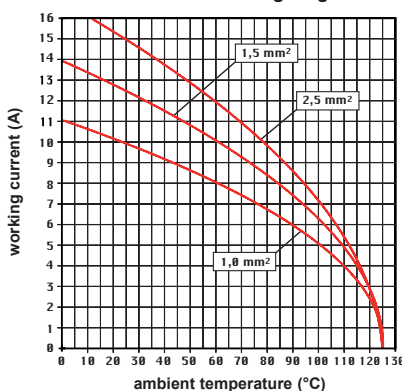

CR CP coding pin with loss of one contact (page 689)





# CD 25 poles + ⊕ 10A - 250V

enclosures: size "66.16"	page:
IL-BRID	378 - 382
CZ7 IP67, single lever	385
W-TYPE for aggressive environments	520
E-Xtreme® corrosion proof	541
EMC	577
panel supports: COB + adaptor	page: 652 - 654

## inserts, crimp connections

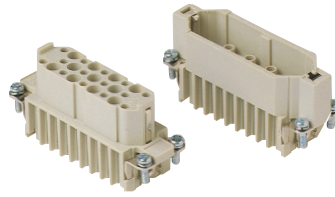

## 10A crimp contacts silver and gold plated



description	part No.	part No.	part No.
without contacts (to be ordered separately)			
female inserts for female contacts	<b>CDF 25</b>		
male inserts for male contacts	<b>CDM 25</b>		
10A female contacts			
0,14-0,37 mm <sup>2</sup> AWG 26-22 identification No. 1		<b>CDFA 0.3</b>	<b>CDFD 0.3</b>
0,5 mm <sup>2</sup> AWG 20 identification No. 2		<b>CDFA 0.5</b>	<b>CDFD 0.5</b>
0,75 mm <sup>2</sup> AWG 18 identification No. ②		<b>CDFA 0.7</b>	<b>CDFD 0.7</b>
1 mm <sup>2</sup> AWG 18 identification No. 3		<b>CDFA 1.0</b>	<b>CDFD 1.0</b>
1,5 mm <sup>2</sup> AWG 16 identification No. 4		<b>CDFA 1.5</b>	<b>CDFD 1.5</b>
2,5 mm <sup>2</sup> AWG 14 identification No. 5		<b>CDFA 2.5</b>	<b>CDFD 2.5</b>
10A male contacts			
0,14-0,37 mm <sup>2</sup> AWG 26-22 identification No. 1		<b>CDMA 0.3</b>	<b>CDMD 0.3</b>
0,5 mm <sup>2</sup> AWG 20 identification No. 2		<b>CDMA 0.5</b>	<b>CDMD 0.5</b>
0,75 mm <sup>2</sup> AWG 18 identification No. ②		<b>CDMA 0.7</b>	<b>CDMD 0.7</b>
1 mm <sup>2</sup> AWG 18 identification No. 3		<b>CDMA 1.0</b>	<b>CDMD 1.0</b>
1,5 mm <sup>2</sup> AWG 16 identification No. 4		<b>CDMA 1.5</b>	<b>CDMD 1.5</b>
2,5 mm <sup>2</sup> AWG 14 identification No. 5		<b>CDMA 2.5</b>	<b>CDMD 2.5</b>

- characteristics according to EN 61984:  
**10A 250V 4kV 3**  
**10A 230/400V 4kV 2**
- compliant with DIN EC 175-301-801 standard
- certified
- rated voltage according to UL/CSA: 600V
- insulation resistance: ≥ 10 GΩ
- ambient temperature limit: -40 °C ... +125 °C
- made of self-extinguishing thermoplastic resin UL 94V-0
- mechanical life: ≥ 500 cycles
- contact resistance: ≤ 3 mΩ
- for applications requiring higher voltages, please see the special voltage application section on page 65
- **it is recommended to crimp the contacts with crimping tools homologated by ILME** (please see the crimping tool section 10A contacts, CDF and CDM series on pages 705 - 741)
- for max. current load see the connector inserts derating diagram below; for more information see page 28

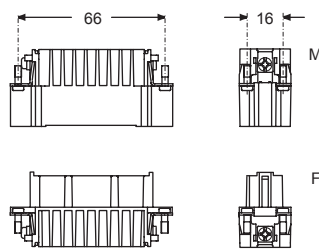

contacts side (front view)

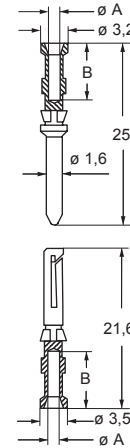
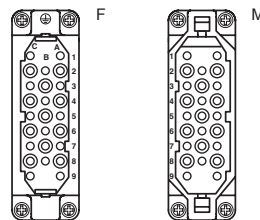

### CDF and CDM contacts

conductor section mm <sup>2</sup>	conductor slot ø A (mm)	conductors stripping length B (mm)
0,14-0,37	0,9	8
0,5	1,1	8
0,75	1,3	8
1,0	1,45	8
1,5	1,8	8
2,5	2,2	6

CD 25 poles connector inserts  
Maximum current load derating diagram

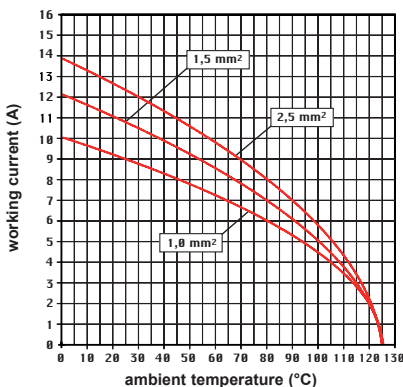

CR CP coding pin  
with loss of one contact  
(page 689)



+ for basic or high thickness gold plating, please refer to page 674

# CD 40 poles + ⊕ 10A - 250V

enclosures: size "77.27"	page:
C-TYPE IP65/IP66	402 - 411
C7 IP67, two levers	439 - 440
V-TYPE IP65/IP66, single lever	454 - 458
BIG hoods	470 - 471
T-TYPE IP65 insulating	484 - 485
T-TYPE / W IP66 insulating	491
HYGIENIC T-TYPE / H IP66/IP69	503
HYGIENIC T-TYPE / C IP66/IP69, -50 °C	508
W-TYPE for aggressive environments	523
E-Xtreme® corrosion proof	534 - 535, 544, 554 - 555
EMC	580
Central lever	609 - 611
LS-TYPE	622 - 623
IP68	640 - 643
panel supports: COB	page: 652 - 653

## inserts, crimp connections

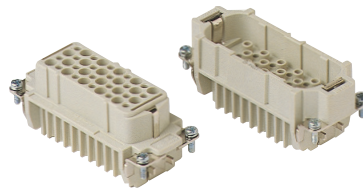

## 10A crimp contacts silver and gold plated



description	part No.	part No.	part No.
without contacts (to be ordered separately)			
female inserts for female contacts	<b>CDFA 40</b>		
male inserts for male contacts	<b>CDM 40</b>		
10A female contacts			
0,14-0,37 mm <sup>2</sup> AWG 26-22 identification No. 1		<b>CDFA 0.3</b>	<b>CDFD 0.3</b>
0,5 mm <sup>2</sup> AWG 20 identification No. 2		<b>CDFA 0.5</b>	<b>CDFD 0.5</b>
0,75 mm <sup>2</sup> AWG 18 identification No. ②		<b>CDFA 0.7</b>	<b>CDFD 0.7</b>
1 mm <sup>2</sup> AWG 18 identification No. 3		<b>CDFA 1.0</b>	<b>CDFD 1.0</b>
1,5 mm <sup>2</sup> AWG 16 identification No. 4		<b>CDFA 1.5</b>	<b>CDFD 1.5</b>
2,5 mm <sup>2</sup> AWG 14 identification No. 5		<b>CDFA 2.5</b>	<b>CDFD 2.5</b>
10A male contacts			
0,14-0,37 mm <sup>2</sup> AWG 26-22 identification No. 1		<b>CDMA 0.3</b>	<b>CDMD 0.3</b>
0,5 mm <sup>2</sup> AWG 20 identification No. 2		<b>CDMA 0.5</b>	<b>CDMD 0.5</b>
0,75 mm <sup>2</sup> AWG 18 identification No. ②		<b>CDMA 0.7</b>	<b>CDMD 0.7</b>
1 mm <sup>2</sup> AWG 18 identification No. 3		<b>CDMA 1.0</b>	<b>CDMD 1.0</b>
1,5 mm <sup>2</sup> AWG 16 identification No. 4		<b>CDMA 1.5</b>	<b>CDMD 1.5</b>
2,5 mm <sup>2</sup> AWG 14 identification No. 5		<b>CDMA 2.5</b>	<b>CDMD 2.5</b>

- characteristics according to EN 61984:  
**10A 250V 4kV 3**  
**10A 230/400V 4kV 2**
- compliant with DIN EC 175-301-801 standard
- certified
- rated voltage according to UL/CSA: 600V
- insulation resistance: ≥ 10 GΩ
- ambient temperature limit: -40 °C ... +125 °C
- made of self-extinguishing thermoplastic resin UL 94V-0
- mechanical life: ≥ 500 cycles
- contact resistance: ≤ 3 mΩ
- for applications requiring higher voltages, please see the special voltage application section on page 65
- **it is recommended to crimp the contacts with crimping tools homologated by ILME** (please see the crimping tool section 10A contacts, CDF and CDM series on pages 705 - 741)
- for max. current load see the connector inserts derating diagram below; for more information see page 28

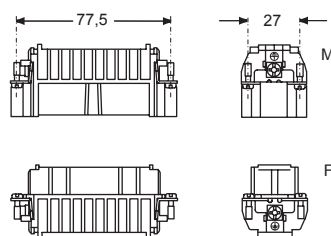

contacts side (front view)

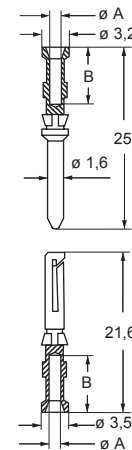
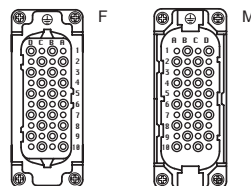

### CDF and CDM contacts

conductor section mm <sup>2</sup>	conductor slot Ø A (mm)	conductors stripping length B (mm)
0,14-0,37	0,9	8
0,5	1,1	8
0,75	1,3	8
1,0	1,45	8
1,5	1,8	8
2,5	2,2	6

CD 40 poles connector inserts  
Maximum current load derating diagram

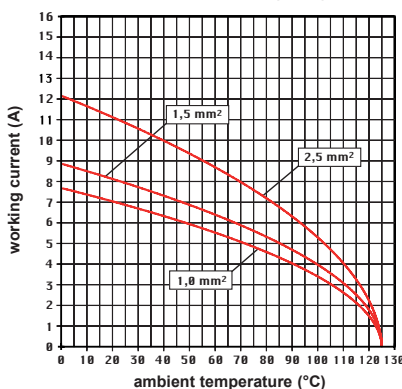

CR CP coding pin with loss of one contact (page 689)



† for basic or high thickness gold plating, please refer to page 674

# CD 50 poles + ⊕ 10A - 250V

enclosures:  
size "66.40"

page:

C-TYPE IP65/IP66  
W-TYPE for aggressive environments  
E-Xtreme® corrosion proof

431 - 434  
527  
548

## inserts, crimp connections

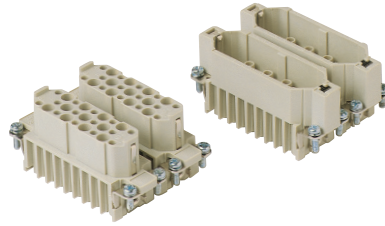

## 10A crimp contacts silver and gold plated



description	part No.	part No.	part No.	part No.
without contacts (to be ordered separately)				
female inserts, No. (A1÷C9) and (ZA1÷ZC9) *	<b>CDF 25</b>	<b>CDF 25 Z *</b>		
male inserts, No. (A1÷C9) and (ZA1÷ZC9) *	<b>CDM 25</b>	<b>CDM 25 Z *</b>		
<b>10A female contacts</b>				
0,14-0,37 mm <sup>2</sup> AWG 26-22 identification No. 1			<b>CDFA 0.3</b>	<b>CDFD 0.3</b>
0,5 mm <sup>2</sup> AWG 20 identification No. 2			<b>CDFA 0.5</b>	<b>CDFD 0.5</b>
0,75 mm <sup>2</sup> AWG 18 identification No. ②			<b>CDFA 0.7</b>	<b>CDFD 0.7</b>
1 mm <sup>2</sup> AWG 18 identification No. 3			<b>CDFA 1.0</b>	<b>CDFD 1.0</b>
1,5 mm <sup>2</sup> AWG 16 identification No. 4			<b>CDFA 1.5</b>	<b>CDFD 1.5</b>
2,5 mm <sup>2</sup> AWG 14 identification No. 5			<b>CDFA 2.5</b>	<b>CDFD 2.5</b>
<b>10A male contacts</b>				
0,14-0,37 mm <sup>2</sup> AWG 26-22 identification No. 1			<b>CDMA 0.3</b>	<b>CDMD 0.3</b>
0,5 mm <sup>2</sup> AWG 20 identification No. 2			<b>CDMA 0.5</b>	<b>CDMD 0.5</b>
0,75 mm <sup>2</sup> AWG 18 identification No. ②			<b>CDMA 0.7</b>	<b>CDMD 0.7</b>
1 mm <sup>2</sup> AWG 18 identification No. 3			<b>CDMA 1.0</b>	<b>CDMD 1.0</b>
1,5 mm <sup>2</sup> AWG 16 identification No. 4			<b>CDMA 1.5</b>	<b>CDMD 1.5</b>
2,5 mm <sup>2</sup> AWG 14 identification No. 5			<b>CDMA 2.5</b>	<b>CDMD 2.5</b>

\* coding compliant with EUROMAP recommendations

- characteristics according to EN 61984:  
**10A 250V 4kV 3**  
**10A 230/400V 4kV 2**
- compliant with DIN EC 175-301-801 standard
- certified
- rated voltage according to UL/CSA: 600V
- insulation resistance: ≥ 10 GΩ
- ambient temperature limit: -40 °C ... +125 °C
- made of self-extinguishing thermoplastic resin UL 94V-0
- mechanical life: ≥ 500 cycles
- contact resistance: ≤ 3 mΩ
- for applications requiring higher voltages, please see the special voltage application section on page 65
- **it is recommended to crimp the contacts with crimping tools homologated by ILME** (please see the crimping tool section 10A contacts, CDF and CDM series on pages 705 - 741)
- for max. current load see the connector inserts derating diagram below; for more information see page 28

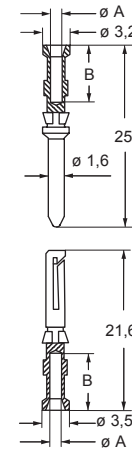
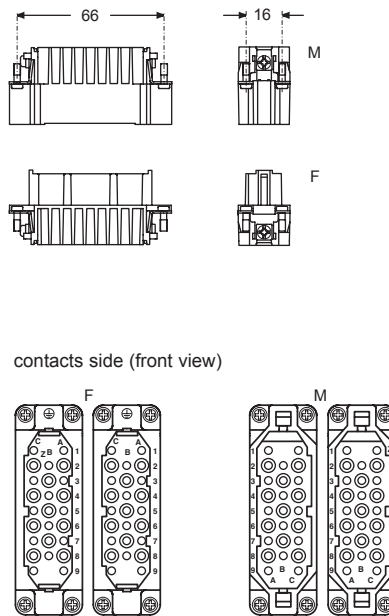

### CDF and CDM contacts

conductor section mm <sup>2</sup>	conductor slot ø A (mm)	conductors stripping length B (mm)
0,14-0,37	0,9	8
0,5	1,1	8
0,75	1,3	8
1,0	1,45	8
1,5	1,8	8
2,5	2,2	6

CD 50 poles connector inserts  
Maximum current load derating diagram

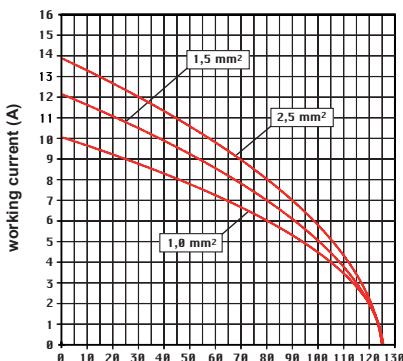

CR CP coding pin  
with loss of one contact  
(page 689)



+ for basic or high thickness gold plating, please refer to page 674

# CD 64 poles + ⊕ 10A - 250V

enclosures: size "104.27"	page:
C-TYPE IP65/IP66	412 - 423
C7 IP67, two levers	441 - 442
V-TYPE IP65/IP66, single lever	459 - 463
BIG hoods	472 - 473
T-TYPE IP65 insulating	486 - 487
T-TYPE / W IP66 insulating	492
HYGIENIC T-TYPE / H IP66/IP69	504
HYGIENIC T-TYPE / C IP66/IP69, -50 °C	509
W-TYPE for aggressive environments	524
E-Xtreme® corrosion proof	536 - 537, 545, 556 - 557
EMC	581
Central lever	612 - 614
LS-TYPE	624 - 625
IP68	644 - 647
panel supports: COB	page: 652 - 653

## inserts, crimp connections

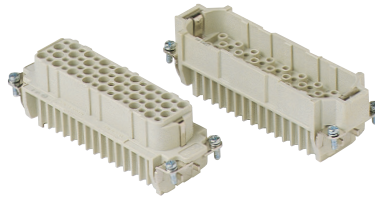

## 10A crimp contacts silver and gold plated



description	part No.	part No.	part No.
without contacts (to be ordered separately)			
female inserts for female contacts	<b>CDF 64</b>		
male inserts for male contacts	<b>CDM 64</b>		
10A female contacts			
0,14-0,37 mm <sup>2</sup> AWG 26-22 identification No. 1		<b>CDFA 0.3</b>	<b>CDFD 0.3</b>
0,5 mm <sup>2</sup> AWG 20 identification No. 2		<b>CDFA 0.5</b>	<b>CDFD 0.5</b>
0,75 mm <sup>2</sup> AWG 18 identification No. ②		<b>CDFA 0.7</b>	<b>CDFD 0.7</b>
1 mm <sup>2</sup> AWG 18 identification No. 3		<b>CDFA 1.0</b>	<b>CDFD 1.0</b>
1,5 mm <sup>2</sup> AWG 16 identification No. 4		<b>CDFA 1.5</b>	<b>CDFD 1.5</b>
2,5 mm <sup>2</sup> AWG 14 identification No. 5		<b>CDFA 2.5</b>	<b>CDFD 2.5</b>
10A male contacts			
0,14-0,37 mm <sup>2</sup> AWG 26-22 identification No. 1		<b>CDMA 0.3</b>	<b>CDMD 0.3</b>
0,5 mm <sup>2</sup> AWG 20 identification No. 2		<b>CDMA 0.5</b>	<b>CDMD 0.5</b>
0,75 mm <sup>2</sup> AWG 18 identification No. ②		<b>CDMA 0.7</b>	<b>CDMD 0.7</b>
1 mm <sup>2</sup> AWG 18 identification No. 3		<b>CDMA 1.0</b>	<b>CDMD 1.0</b>
1,5 mm <sup>2</sup> AWG 16 identification No. 4		<b>CDMA 1.5</b>	<b>CDMD 1.5</b>
2,5 mm <sup>2</sup> AWG 14 identification No. 5		<b>CDMA 2.5</b>	<b>CDMD 2.5</b>

- characteristics according to EN 61984:  
**10A 250V 4kV 3**  
**10A 230/400V 4kV 2**
- compliant with DIN EC 175-301-801 standard
- certified
- rated voltage according to UL/CSA: 600V
- insulation resistance: ≥ 10 GΩ
- ambient temperature limit: -40 °C ... +125 °C
- made of self-extinguishing thermoplastic resin UL 94V-0
- mechanical life: ≥ 500 cycles
- contact resistance: ≤ 3 mΩ
- for applications requiring higher voltages, please see the special voltage application section on page 65
- **it is recommended to crimp the contacts with crimping tools homologated by ILME** (please see the crimping tool section 10A contacts, CDF and CDM series on pages 705 - 741)
- for max. current load see the connector inserts derating diagram below; for more information see page 28

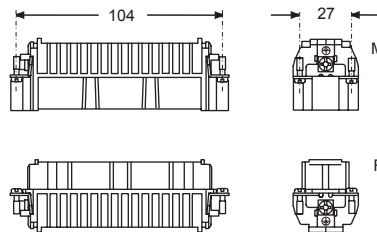

contacts side (front view)

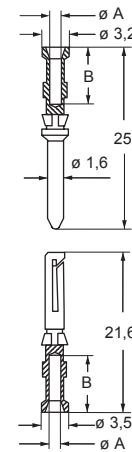
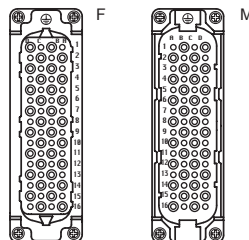

### CDF and CDM contacts

conductor section mm <sup>2</sup>	conductor slot Ø A (mm)	conductors stripping length B (mm)
0,14-0,37	0,9	8
0,5	1,1	8
0,75	1,3	8
1,0	1,45	8
1,5	1,8	8
2,5	2,2	6

† for basic or high thickness gold plating, please refer to page 674

CD 64 poles connector inserts  
Maximum current load derating diagram

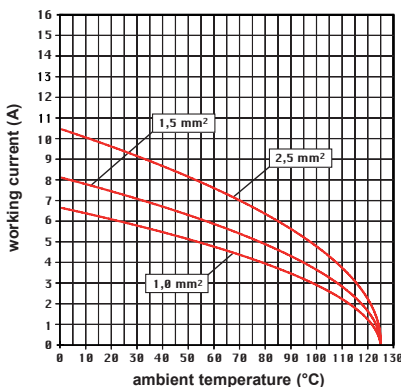

CR CP coding pin with loss of one contact (page 689)



# CD 80 poles + ⊕ 10A - 250V

enclosures:  
size "77.62"

page:

C-TYPE IP65/IP66  
W-TYPE for aggressive environments  
E-Xtreme® corrosion proof

424 - 429  
525  
546

## inserts, crimp connections

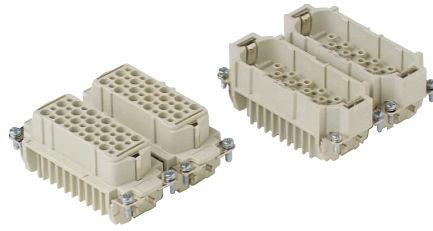

## 10A crimp contacts silver and gold plated



description	part No.	part No.	part No.	part No.
without contacts (to be ordered separately)				
female inserts	<b>CDF 40</b>	<b>CDF 40</b>		
male inserts	<b>CDM 40</b>	<b>CDM 40</b>		
10A female contacts				
0,14-0,37 mm <sup>2</sup> AWG 26-22 identification No. 1			<b>CDFA 0.3</b>	<b>CDFD 0.3</b>
0,5 mm <sup>2</sup> AWG 20 identification No. 2			<b>CDFA 0.5</b>	<b>CDFD 0.5</b>
0,75 mm <sup>2</sup> AWG 18 identification No. ②			<b>CDFA 0.7</b>	<b>CDFD 0.7</b>
1 mm <sup>2</sup> AWG 18 identification No. 3			<b>CDFA 1.0</b>	<b>CDFD 1.0</b>
1,5 mm <sup>2</sup> AWG 16 identification No. 4			<b>CDFA 1.5</b>	<b>CDFD 1.5</b>
2,5 mm <sup>2</sup> AWG 14 identification No. 5			<b>CDFA 2.5</b>	<b>CDFD 2.5</b>
10A male contacts				
0,14-0,37 mm <sup>2</sup> AWG 26-22 identification No. 1			<b>CDMA 0.3</b>	<b>CDMD 0.3</b>
0,5 mm <sup>2</sup> AWG 20 identification No. 2			<b>CDMA 0.5</b>	<b>CDMD 0.5</b>
0,75 mm <sup>2</sup> AWG 18 identification No. ②			<b>CDMA 0.7</b>	<b>CDMD 0.7</b>
1 mm <sup>2</sup> AWG 18 identification No. 3			<b>CDMA 1.0</b>	<b>CDMD 1.0</b>
1,5 mm <sup>2</sup> AWG 16 identification No. 4			<b>CDMA 1.5</b>	<b>CDMD 1.5</b>
2,5 mm <sup>2</sup> AWG 14 identification No. 5			<b>CDMA 2.5</b>	<b>CDMD 2.5</b>

- characteristics according to EN 61984:  
**10A 250V 4kV 3**  
**10A 230/400V 4kV 2**
- compliant with DIN EC 175-301-801 standard
- certified
- rated voltage according to UL/CSA: 600V
- insulation resistance: ≥ 10 GΩ
- ambient temperature limit: -40 °C ... +125 °C
- made of self-extinguishing thermoplastic resin UL 94V-0
- mechanical life: ≥ 500 cycles
- contact resistance: ≤ 3 mΩ
- for applications requiring higher voltages, please see the special voltage application section on page 65
- **it is recommended to crimp the contacts with crimping tools homologated by ILME** (please see the crimping tool section 10A contacts, CDF and CDM series on pages 705 - 741)
- for max. current load see the connector inserts derating diagram below; for more information see page 28

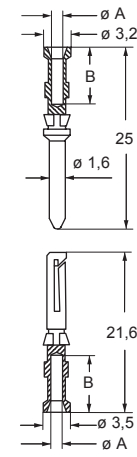
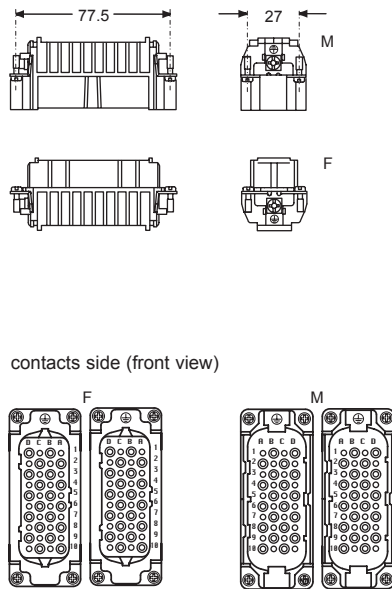

### CDF and CDM contacts

conductor section mm <sup>2</sup>	conductor slot ø A (mm)	conductors stripping length B (mm)
0,14-0,37	0,9	8
0,5	1,1	8
0,75	1,3	8
1,0	1,45	8
1,5	1,8	8
2,5	2,2	6

CD 80 poles connector inserts  
Maximum current load derating diagram

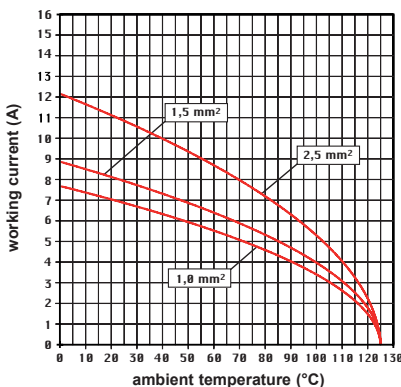

CR CP coding pin  
with loss of one contact  
(page 689)



⊕ for basic or high thickness gold plating, please refer to page 674



# CD 128 poles + ⊕ 10A - 250V

enclosures:  
size "104.62"

page:

C-TYPE IP65/IP66  
W-TYPE for aggressive environments  
E-Xtreme® corrosion proof

430  
526  
547

## inserts, crimp connections

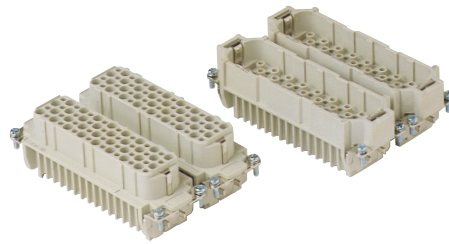

## 10A crimp contacts silver and gold plated



description	part No.	part No.	part No.	part No.
without contacts (to be ordered separately)				
female inserts	<b>CDF 64</b>	<b>CDF 64</b>		
male inserts	<b>CDM 64</b>	<b>CDM 64</b>		
10A female contacts				
0,14-0,37 mm <sup>2</sup> AWG 26-22 identification No. 1			<b>CDFA 0.3</b>	<b>CDFD 0.3</b>
0,5 mm <sup>2</sup> AWG 20 identification No. 2			<b>CDFA 0.5</b>	<b>CDFD 0.5</b>
0,75 mm <sup>2</sup> AWG 18 identification No. ②			<b>CDFA 0.7</b>	<b>CDFD 0.7</b>
1 mm <sup>2</sup> AWG 18 identification No. 3			<b>CDFA 1.0</b>	<b>CDFD 1.0</b>
1,5 mm <sup>2</sup> AWG 16 identification No. 4			<b>CDFA 1.5</b>	<b>CDFD 1.5</b>
2,5 mm <sup>2</sup> AWG 14 identification No. 5			<b>CDFA 2.5</b>	<b>CDFD 2.5</b>
10A male contacts				
0,14-0,37 mm <sup>2</sup> AWG 26-22 identification No. 1			<b>CDMA 0.3</b>	<b>CDMD 0.3</b>
0,5 mm <sup>2</sup> AWG 20 identification No. 2			<b>CDMA 0.5</b>	<b>CDMD 0.5</b>
0,75 mm <sup>2</sup> AWG 18 identification No. ②			<b>CDMA 0.7</b>	<b>CDMD 0.7</b>
1 mm <sup>2</sup> AWG 18 identification No. 3			<b>CDMA 1.0</b>	<b>CDMD 1.0</b>
1,5 mm <sup>2</sup> AWG 16 identification No. 4			<b>CDMA 1.5</b>	<b>CDMD 1.5</b>
2,5 mm <sup>2</sup> AWG 14 identification No. 5			<b>CDMA 2.5</b>	<b>CDMD 2.5</b>

silver plated

gold plated+

- characteristics according to EN 61984:  
**10A 250V 4kV 3**  
**10A 230/400V 4kV 2**
- compliant with DIN EC 175-301-801 standard
- certified
- rated voltage according to UL/CSA: 600V
- insulation resistance: ≥ 10 GΩ
- ambient temperature limit: -40 °C ... +125 °C
- made of self-extinguishing thermoplastic resin UL 94V-0
- mechanical life: ≥ 500 cycles
- contact resistance: ≤ 3 mΩ
- for applications requiring higher voltages, please see the special voltage application section on page 65
- **it is recommended to crimp the contacts with crimping tools homologated by ILME** (please see the crimping tool section 10A contacts, CDF and CDM series on pages 705 - 741)
- for max. current load see the connector inserts derating diagram below; for more information see page 28

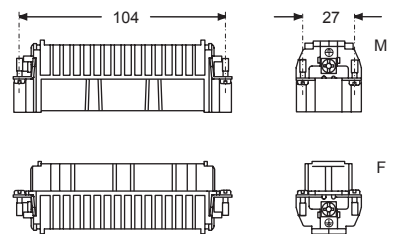

contacts side (front view)

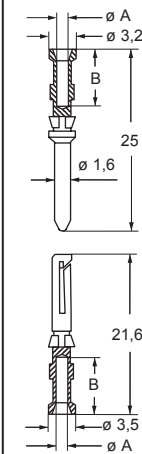
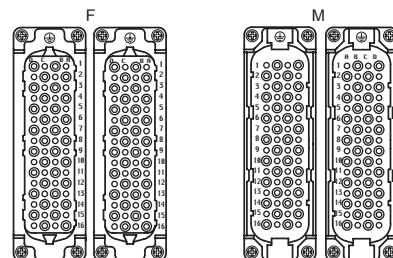

### CDF and CDM contacts

conductor section mm <sup>2</sup>	conductor slot Ø A (mm)	conductors stripping length B (mm)
0,14-0,37	0,9	8
0,5	1,1	8
0,75	1,3	8
1,0	1,45	8
1,5	1,8	8
2,5	2,2	6

† for basic or high thickness gold plating, please refer to page 674

CD 128 poles connector inserts  
Maximum current load derating diagram

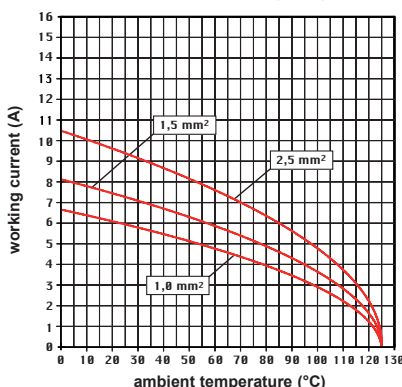

CR CP coding pin with loss of one contact (page 689)





# Special voltages for CDD series

When all the contacts are used, CDD series connector inserts may be used with voltage up to 250V (first column); pollution degree 2, in accordance with the standard EN 61984.

If the number of contacts is reduced and the contacts assigned accordingly, these connectors may be used with higher voltages. This is possible because the decrease in the number of contacts

leads to an increase in clearances (insulating distance in air) and creepage distances (insulating distances along the surface).

When the contacts are arranged as shown below, the inserts may be used at rated voltages of 400V (second column) and 500V (third column); pollution degree 2, in accordance with the standard EN 61984.

**for use up to 250V  
pollution degree 2**

diagrams  
contacts side (front view)

**CDD 24 - 24 + ⊕**

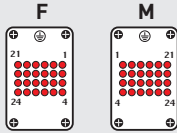

**CDD 42 - 42 + ⊕**

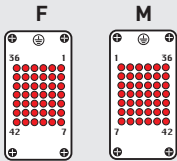

**CDD 72 - 72 + ⊕**

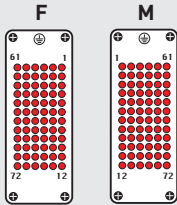

**CDD 108 - 108 + ⊕**

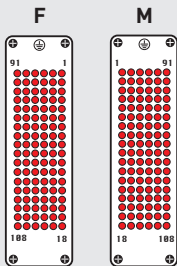

**for use up to 400V  
pollution degree 2**

diagrams  
contacts side (front view)

**CDD 24 - 12 + ⊕**

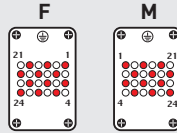

**CDD 42 - 21 + ⊕**

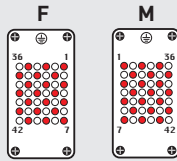

**CDD 72 - 34 + ⊕**

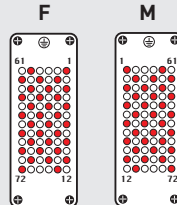

**CDD 108 - 52 + ⊕**

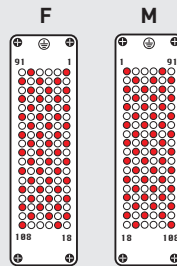

**for use up to 500V  
pollution degree 2**

diagrams  
contacts side (front view)

**CDD 24 - 5 + ⊕**

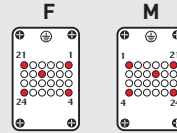

**CDD 42 - 11 + ⊕**

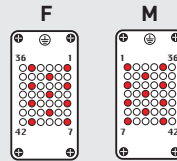

**CDD 72 - 17 + ⊕**

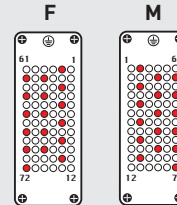

**CDD 108 - 26 + ⊕**

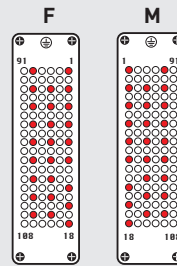

**Legend:**

- working contact
- without contact
- M = male insert
- F = female insert

# CDD 24 poles + ⊕ 10A - 250V

enclosures: size "44.27"	page:
C-TYPE IP65/IP66	387 - 392
C7 IP67, single lever	436 - 437
V-TYPE IP65/IP66, single lever	444 - 447
BIG hoods	466 - 467
T-TYPE IP65 insulating	480 - 481
T-TYPE / W IP66 insulating	489
HYGIENIC T-TYPE / H IP66/IP69	501
HYGIENIC T-TYPE / C IP66/IP69, -50 °C	506
W-TYPE for aggressive environments	521
E-Xtreme® corrosion proof	530 - 531, 542, 550 - 551
EMC	578
Central lever	603 - 605
LS-TYPE	618 - 619
IP68	632 - 635

panel supports:	page:
COB	652 - 653

PCBs interface, see article CIF 2.4 on page 670

## inserts, crimp connections

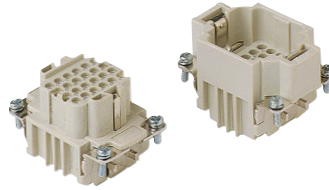

## 10A crimp contacts silver and gold plated



description	part No.	part No.	part No.
without contacts (to be ordered separately)			
female inserts for female contacts	<b>CDDF 24</b>		
male inserts for male contacts	<b>CDDM 24</b>		
10A female contacts			
0,14-0,37 mm <sup>2</sup> AWG 26-22 identification No. 1		<b>CDFA 0.3</b>	<b>CDFD 0.3</b>
0,5 mm <sup>2</sup> AWG 20 identification No. 2		<b>CDFA 0.5</b>	<b>CDFD 0.5</b>
0,75 mm <sup>2</sup> AWG 18 identification No. ②		<b>CDFA 0.7</b>	<b>CDFD 0.7</b>
1 mm <sup>2</sup> AWG 18 identification No. 3		<b>CDFA 1.0</b>	<b>CDFD 1.0</b>
1,5 mm <sup>2</sup> AWG 16 identification No. 4		<b>CDFA 1.5</b>	<b>CDFD 1.5</b>
2,5 mm <sup>2</sup> AWG 14 identification No. 5		<b>CDFA 2.5</b>	<b>CDFD 2.5</b>
10A male contacts			
0,14-0,37 mm <sup>2</sup> AWG 26-22 identification No. 1		<b>CDMA 0.3</b>	<b>CDMD 0.3</b>
0,5 mm <sup>2</sup> AWG 20 identification No. 2		<b>CDMA 0.5</b>	<b>CDMD 0.5</b>
0,75 mm <sup>2</sup> AWG 18 identification No. ②		<b>CDMA 0.7</b>	<b>CDMD 0.7</b>
1 mm <sup>2</sup> AWG 18 identification No. 3		<b>CDMA 1.0</b>	<b>CDMD 1.0</b>
1,5 mm <sup>2</sup> AWG 16 identification No. 4		<b>CDMA 1.5</b>	<b>CDMD 1.5</b>
2,5 mm <sup>2</sup> AWG 14 identification No. 5		<b>CDMA 2.5</b>	<b>CDMD 2.5</b>

- characteristics according to EN 61984:
- 10A 250V 4kV 2**
- certified
- rated voltage according to UL/CSA: 600V
- insulation resistance: ≥ 10 GΩ
- ambient temperature limit: -40 °C ... +125 °C
- made of self-extinguishing thermoplastic resin UL 94V-0
- mechanical life: ≥ 500 cycles
- contact resistance: ≤ 3 mΩ
- for applications requiring higher voltages, please see the special voltage application section on page 75
- **it is recommended to crimp the contacts with crimping tools homologated by ILME** (please see the crimping tool section 10A contacts, CDF and CDM series on pages 705 - 741)
- for max. current load see the connector inserts derating diagram below; for more information see page 28

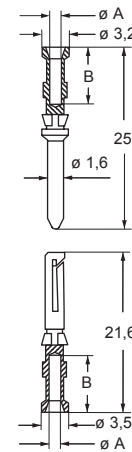
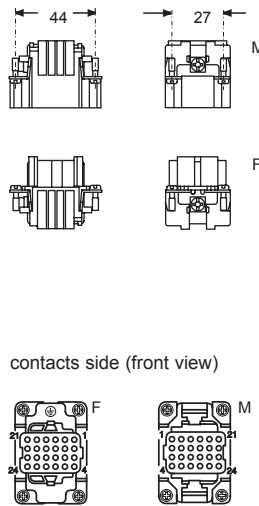

### CDF and CDM contacts

conductor section mm <sup>2</sup>	conductor slot ø A (mm)	conductors stripping length B (mm)
0,14-0,37	0,9	8
0,5	1,1	8
0,75	1,3	8
1,0	1,45	8
1,5	1,8	8
2,5	2,2	6

† for basic or high thickness gold plating, please refer to page 674

**CDD 24 poles connector inserts**  
Maximum current load derating diagram

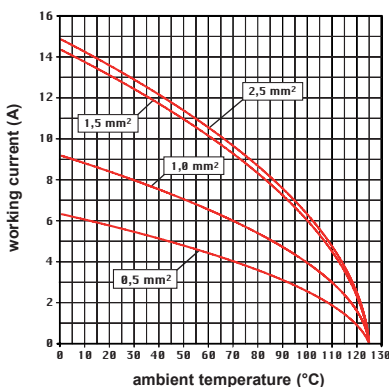

**CR CP coding pin with loss of one contact (page 689)**



# CDD 38 poles + ⊕ 10A - 250V

enclosures: size "66.16"	page:
IL-BRID	378 - 382
CZ7 IP67, single lever	385
W-TYPE for aggressive environments	520
E-Xtreme® corrosion proof	541
EMC	577
panel supports: COB	page: 652 - 653

## inserts, crimp connections

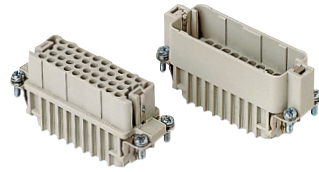

## 10A crimp contacts silver and gold plated



description	part No.	part No.	part No.
without contacts (to be ordered separately)			
female inserts for female contacts	<b>CDDF 38</b>		
male inserts for male contacts	<b>CDDM 38</b>		
10A female contacts			
0,14-0,37 mm <sup>2</sup> AWG 26-22 identification No. 1		<b>CDFA 0.3</b>	<b>CDFD 0.3</b>
0,5 mm <sup>2</sup> AWG 20 identification No. 2		<b>CDFA 0.5</b>	<b>CDFD 0.5</b>
0,75 mm <sup>2</sup> AWG 18 identification No. ②		<b>CDFA 0.7</b>	<b>CDFD 0.7</b>
1 mm <sup>2</sup> AWG 18 identification No. 3		<b>CDFA 1.0</b>	<b>CDFD 1.0</b>
1,5 mm <sup>2</sup> AWG 16 identification No. 4		<b>CDFA 1.5</b>	<b>CDFD 1.5</b>
2,5 mm <sup>2</sup> AWG 14 identification No. 5		<b>CDFA 2.5</b>	<b>CDFD 2.5</b>
10A male contacts			
0,14-0,37 mm <sup>2</sup> AWG 26-22 identification No. 1		<b>CDMA 0.3</b>	<b>CDMD 0.3</b>
0,5 mm <sup>2</sup> AWG 20 identification No. 2		<b>CDMA 0.5</b>	<b>CDMD 0.5</b>
0,75 mm <sup>2</sup> AWG 18 identification No. ②		<b>CDMA 0.7</b>	<b>CDMD 0.7</b>
1 mm <sup>2</sup> AWG 18 identification No. 3		<b>CDMA 1.0</b>	<b>CDMD 1.0</b>
1,5 mm <sup>2</sup> AWG 16 identification No. 4		<b>CDMA 1.5</b>	<b>CDMD 1.5</b>
2,5 mm <sup>2</sup> AWG 14 identification No. 5		<b>CDMA 2.5</b>	<b>CDMD 2.5</b>

- characteristics according to EN 61984:
- 10A 250V 4kV 2**
- certified
- rated voltage according to UL/CSA: 600V
- insulation resistance: ≥ 10 GΩ
- ambient temperature limit: -40 °C ... +125 °C
- made of self-extinguishing thermoplastic resin UL 94V-0
- mechanical life: ≥ 500 cycles
- contact resistance: ≤ 3 mΩ
- for applications requiring higher voltages, please see the special voltage application section on page 75
- **it is recommended to crimp the contacts with crimping tools homologated by ILME** (please see the crimping tool section 10A contacts, CDF and CDM series on pages 705 - 741)
- for max. current load see the connector inserts derating diagram below; for more information see page 28

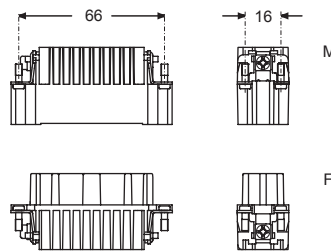

contacts side (front view)

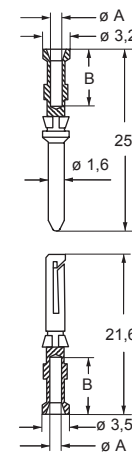
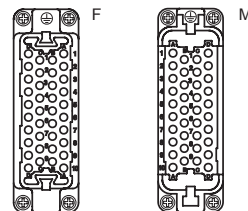

### CDF and CDM contacts

conductor section mm <sup>2</sup>	conductor slot $\phi A$ (mm)	conductors stripping length B (mm)
0,14-0,37	0,9	8
0,5	1,1	8
0,75	1,3	8
1,0	1,45	8
1,5	1,8	8
2,5	2,2	6

CDD 38 poles connector inserts  
Maximum current load derating diagram

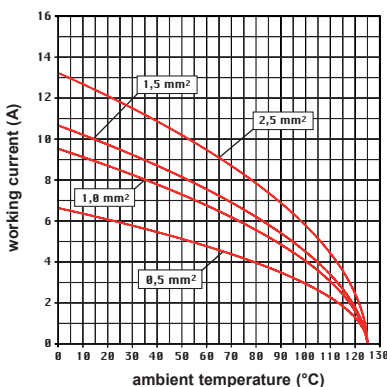

CR CP coding pin with loss of one contact (page 689)



+ for basic or high thickness gold plating, please refer to page 674

# CDD 42 poles + ⊕ 10A - 250V

enclosures: size "57.27"	page:
C-TYPE IP65/IP66	393 - 401
C7 IP67, two levers	438
V-TYPE IP65/IP66, single lever	448 - 453
BIG hoods	468 - 469
T-TYPE IP65 insulating	482 - 483
T-TYPE / W IP66 insulating	490
HYGIENIC T-TYPE / H IP66/IP69	502
HYGIENIC T-TYPE / C IP66/IP69, -50 °C	507
W-TYPE for aggressive environments	522
E-Xtreme® corrosion proof	532 - 533, 543, 552 - 553
EMC	579
Central lever	606 - 608
LS-TYPE	620 - 621
IP68	636 - 639

panel supports:	page:
COB	652 - 653

PCBs interface, see article CIF 2.4 on page 670

## inserts, crimp connections

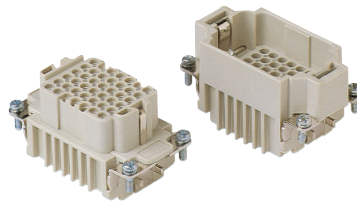

## 10A crimp contacts silver and gold plated



description	part No.	part No.	part No.
without contacts (to be ordered separately)			
female inserts for female contacts	<b>CDDF 42</b>		
male inserts for male contacts	<b>CDDM 42</b>		
10A female contacts			
0,14-0,37 mm <sup>2</sup> AWG 26-22 identification No. 1		<b>CDFA 0.3</b>	<b>CDFD 0.3</b>
0,5 mm <sup>2</sup> AWG 20 identification No. 2		<b>CDFA 0.5</b>	<b>CDFD 0.5</b>
0,75 mm <sup>2</sup> AWG 18 identification No. ②		<b>CDFA 0.7</b>	<b>CDFD 0.7</b>
1 mm <sup>2</sup> AWG 18 identification No. 3		<b>CDFA 1.0</b>	<b>CDFD 1.0</b>
1,5 mm <sup>2</sup> AWG 16 identification No. 4		<b>CDFA 1.5</b>	<b>CDFD 1.5</b>
2,5 mm <sup>2</sup> AWG 14 identification No. 5		<b>CDFA 2.5</b>	<b>CDFD 2.5</b>
10A male contacts			
0,14-0,37 mm <sup>2</sup> AWG 26-22 identification No. 1		<b>CDMA 0.3</b>	<b>CDMD 0.3</b>
0,5 mm <sup>2</sup> AWG 20 identification No. 2		<b>CDMA 0.5</b>	<b>CDMD 0.5</b>
0,75 mm <sup>2</sup> AWG 18 identification No. ②		<b>CDMA 0.7</b>	<b>CDMD 0.7</b>
1 mm <sup>2</sup> AWG 18 identification No. 3		<b>CDMA 1.0</b>	<b>CDMD 1.0</b>
1,5 mm <sup>2</sup> AWG 16 identification No. 4		<b>CDMA 1.5</b>	<b>CDMD 1.5</b>
2,5 mm <sup>2</sup> AWG 14 identification No. 5		<b>CDMA 2.5</b>	<b>CDMD 2.5</b>

- characteristics according to EN 61984:

### 10A 250V 4kV 2

- certified
- rated voltage according to UL/CSA: 600V
- insulation resistance: ≥ 10 GΩ
- ambient temperature limit: -40 °C ... +125 °C
- made of self-extinguishing thermoplastic resin UL 94V-0
- mechanical life: ≥ 500 cycles
- contact resistance: ≤ 3 mΩ
- for applications requiring higher voltages, please see the special voltage application section on page 75
- **it is recommended to crimp the contacts with crimping tools homologated by ILME** (please see the crimping tool section 10A contacts, CDF and CDM series on pages 705 - 741)
- for max. current load see the connector inserts derating diagram below; for more information see page 28

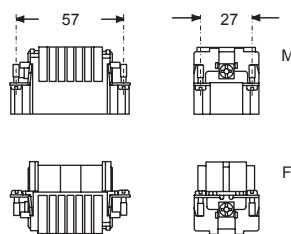

contacts side (front view)

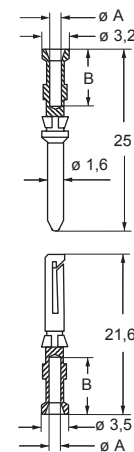
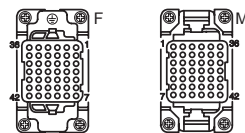

### CDF and CDM contacts

conductor section mm <sup>2</sup>	conductor slot Ø A (mm)	conductors stripping length B (mm)
0,14-0,37	0,9	8
0,5	1,1	8
0,75	1,3	8
1,0	1,45	8
1,5	1,8	8
2,5	2,2	6

CDD 42 poles connector inserts  
Maximum current load derating diagram

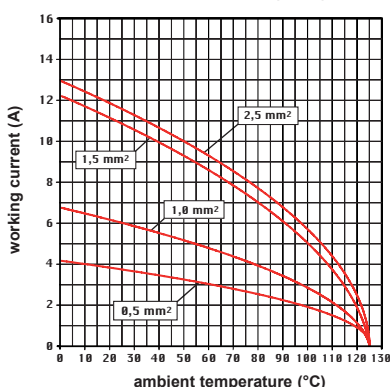

CR CP coding pin with loss of one contact (page 689)



† for basic or high thickness gold plating, please refer to page 674

# CDD 72 poles + ⊕ 10A - 250V

enclosures: size "77.27"	page:
C-TYPE IP65/IP66	402 - 411
C7 IP67, two levers	439 - 440
V-TYPE IP65/IP66, single lever	454 - 458
BIG hoods	470 - 471
T-TYPE IP65 insulating	484 - 485
T-TYPE / W IP66 insulating	491
HYGIENIC T-TYPE / H IP66/IP69	503
HYGIENIC T-TYPE / C IP66/IP69, -50 °C	508
W-TYPE for aggressive environments	523
E-Xtreme® corrosion proof	534 - 535, 544, 554 - 555
EMC	580
Central lever	609 - 611
LS-TYPE	622 - 623
IP68	640 - 643
panel supports: COB	page: 652 - 653

## inserts, crimp connections

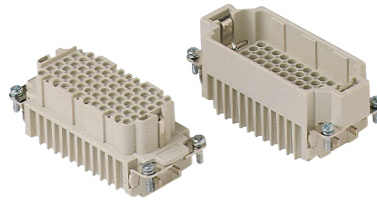

## 10A crimp contacts silver and gold plated



description	part No.	part No.	part No.
without contacts (to be ordered separately)			
female inserts for female contacts	<b>CDDF 72</b>		
male inserts for male contacts	<b>CDDM 72</b>		
10A female contacts			
0,14-0,37 mm <sup>2</sup> AWG 26-22 identification No. 1		<b>CDFA 0.3</b>	<b>CDFD 0.3</b>
0,5 mm <sup>2</sup> AWG 20 identification No. 2		<b>CDFA 0.5</b>	<b>CDFD 0.5</b>
0,75 mm <sup>2</sup> AWG 18 identification No. ②		<b>CDFA 0.7</b>	<b>CDFD 0.7</b>
1 mm <sup>2</sup> AWG 18 identification No. 3		<b>CDFA 1.0</b>	<b>CDFD 1.0</b>
1,5 mm <sup>2</sup> AWG 16 identification No. 4		<b>CDFA 1.5</b>	<b>CDFD 1.5</b>
2,5 mm <sup>2</sup> AWG 14 identification No. 5		<b>CDFA 2.5</b>	<b>CDFD 2.5</b>
10A male contacts			
0,14-0,37 mm <sup>2</sup> AWG 26-22 identification No. 1		<b>CDMA 0.3</b>	<b>CDMD 0.3</b>
0,5 mm <sup>2</sup> AWG 20 identification No. 2		<b>CDMA 0.5</b>	<b>CDMD 0.5</b>
0,75 mm <sup>2</sup> AWG 18 identification No. ②		<b>CDMA 0.7</b>	<b>CDMD 0.7</b>
1 mm <sup>2</sup> AWG 18 identification No. 3		<b>CDMA 1.0</b>	<b>CDMD 1.0</b>
1,5 mm <sup>2</sup> AWG 16 identification No. 4		<b>CDMA 1.5</b>	<b>CDMD 1.5</b>
2,5 mm <sup>2</sup> AWG 14 identification No. 5		<b>CDMA 2.5</b>	<b>CDMD 2.5</b>

- characteristics according to EN 61984:

### 10A 250V 4kV 2

- certified
- rated voltage according to UL/CSA: 600V
- insulation resistance: ≥ 10 GΩ
- ambient temperature limit: -40 °C ... +125 °C
- made of self-extinguishing thermoplastic resin UL 94V-0
- mechanical life: ≥ 500 cycles
- contact resistance: ≤ 3 mΩ
- for applications requiring higher voltages, please see the special voltage application section on page 75
- **it is recommended to crimp the contacts with crimping tools homologated by ILME** (please see the crimping tool section 10A contacts, CDF and CDM series on pages 705 - 741)
- for max. current load see the connector inserts derating diagram below; for more information see page 28

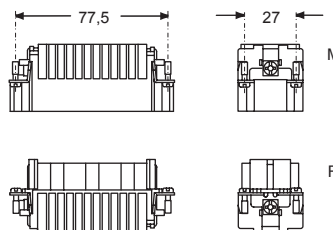

contacts side (front view)

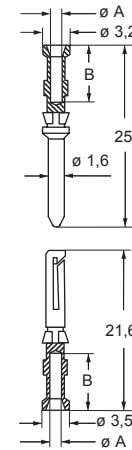
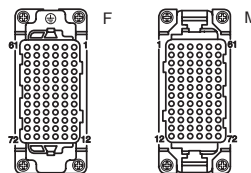

### CDF and CDM contacts

conductor section mm <sup>2</sup>	conductor slot ø A (mm)	conductors stripping length B (mm)
0,14-0,37	0,9	8
0,5	1,1	8
0,75	1,3	8
1,0	1,45	8
1,5	1,8	8
2,5	2,2	6

CDD 72 poles connector inserts  
Maximum current load derating diagram

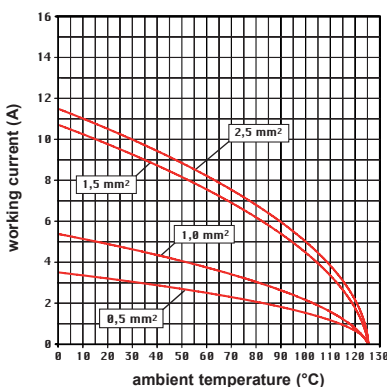

CR CP coding pin with loss of one contact (page 689)



+ for basic or high thickness gold plating, please refer to page 674

# CDD 76 poles + ⊕ 10A - 250V

enclosures:  
size "66.40"

page:

C-TYPE IP65/IP66  
W-TYPE for aggressive environments

431 - 434  
527

## inserts, crimp connections

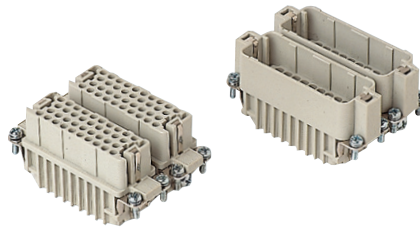

## 10A crimp contacts silver and gold plated



description	part No.	part No.	part No.	part No.
without contacts (to be ordered separately)				
female inserts	<b>CDDF 38</b>	<b>CDDF 38</b>		
male inserts	<b>CDDM 38</b>	<b>CDDM 38</b>		
10A female contacts				
0,14-0,37 mm <sup>2</sup> AWG 26-22 identification No. 1			<b>CDFA 0.3</b>	<b>CDFD 0.3</b>
0,5 mm <sup>2</sup> AWG 20 identification No. 2			<b>CDFA 0.5</b>	<b>CDFD 0.5</b>
0,75 mm <sup>2</sup> AWG 18 identification No. ②			<b>CDFA 0.7</b>	<b>CDFD 0.7</b>
1 mm <sup>2</sup> AWG 18 identification No. 3			<b>CDFA 1.0</b>	<b>CDFD 1.0</b>
1,5 mm <sup>2</sup> AWG 16 identification No. 4			<b>CDFA 1.5</b>	<b>CDFD 1.5</b>
2,5 mm <sup>2</sup> AWG 14 identification No. 5			<b>CDFA 2.5</b>	<b>CDFD 2.5</b>
10A male contacts				
0,14-0,37 mm <sup>2</sup> AWG 26-22 identification No. 1			<b>CDMA 0.3</b>	<b>CDMD 0.3</b>
0,5 mm <sup>2</sup> AWG 20 identification No. 2			<b>CDMA 0.5</b>	<b>CDMD 0.5</b>
0,75 mm <sup>2</sup> AWG 18 identification No. ②			<b>CDMA 0.7</b>	<b>CDMD 0.7</b>
1 mm <sup>2</sup> AWG 18 identification No. 3			<b>CDMA 1.0</b>	<b>CDMD 1.0</b>
1,5 mm <sup>2</sup> AWG 16 identification No. 4			<b>CDMA 1.5</b>	<b>CDMD 1.5</b>
2,5 mm <sup>2</sup> AWG 14 identification No. 5			<b>CDMA 2.5</b>	<b>CDMD 2.5</b>

silver plated

gold plated+

- characteristics according to EN 61984:

**10A 250V 4kV 2**

- certified
- rated voltage according to UL/CSA: 600V
- insulation resistance: ≥ 10 GΩ
- ambient temperature limit: -40 °C ... +125 °C
- made of self-extinguishing thermoplastic resin UL 94V-0
- mechanical life: ≥ 500 cycles
- contact resistance: ≤ 3 mΩ
- for applications requiring higher voltages, please see the special voltage application section on page 75
- **it is recommended to crimp the contacts with crimping tools homologated by ILME** (please see the crimping tool section 10A contacts, CDF and CDM series on pages 705 - 741)
- for max. current load see the connector inserts derating diagram below; for more information see page 28

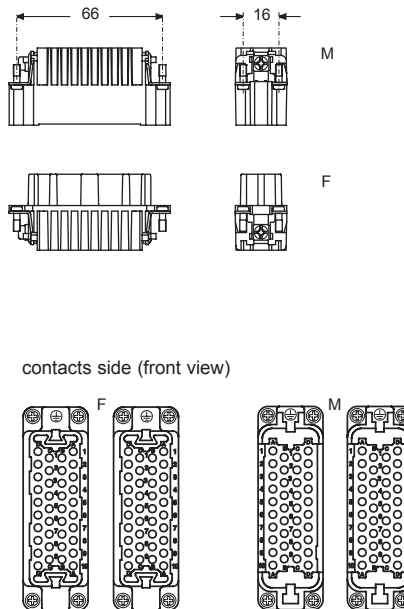

contacts side (front view)

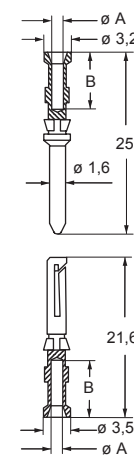

### CDF and CDM contacts

conductor section mm <sup>2</sup>	conductor slot ø A (mm)	conductors stripping length B (mm)
0,14-0,37	0,9	8
0,5	1,1	8
0,75	1,3	8
1,0	1,45	8
1,5	1,8	8
2,5	2,2	6

+ for basic or high thickness gold plating, please refer to page 674

**CDD 76 poles connector inserts  
Maximum current load derating diagram**

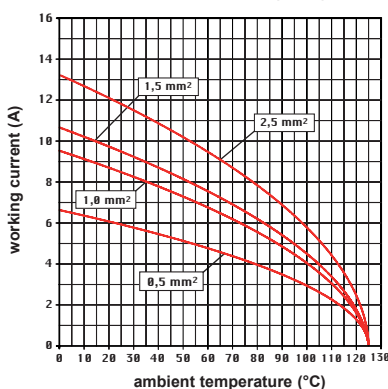

CR CP coding pin with loss of one contact (page 689)





# CDD 108 poles + ⊕ 10A - 250V

enclosures: size "104.27"	page:
C-TYPE IP65/IP66	412 - 423
C7 IP67, two levers	441 - 442
V-TYPE IP65/IP66, single lever	459 - 463
BIG hoods	472 - 473
T-TYPE IP65 insulating	486 - 487
T-TYPE / W IP66 insulating	492
HYGIENIC T-TYPE / H IP66/IP69	504
HYGIENIC T-TYPE / C IP66/IP69, -50 °C	509
W-TYPE for aggressive environments	524
E-Xtreme® corrosion proof	536 - 537, 545, 556 - 557
EMC	581
Central lever	612 - 614
LS-TYPE	624 - 625
IP68	644 - 647
panel supports:	page:
COB	652 - 653

## inserts, crimp connections

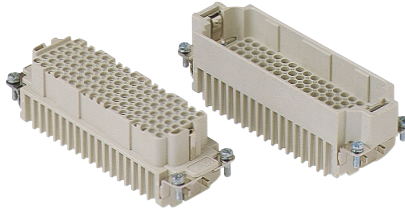

## 10A crimp contacts silver and gold plated



PCBs interface, see article CIF 2.4 on page 670

description	part No.	part No.	part No.
without contacts (to be ordered separately)			
female inserts for female contacts	<b>CDDF 108</b>		
male inserts for male contacts	<b>CDDM 108</b>		
10A female contacts			
0,14-0,37 mm <sup>2</sup> AWG 26-22 identification No. 1		<b>CDFA 0.3</b>	<b>CDFD 0.3</b>
0,5 mm <sup>2</sup> AWG 20 identification No. 2		<b>CDFA 0.5</b>	<b>CDFD 0.5</b>
0,75 mm <sup>2</sup> AWG 18 identification No. ②		<b>CDFA 0.7</b>	<b>CDFD 0.7</b>
1 mm <sup>2</sup> AWG 18 identification No. 3		<b>CDFA 1.0</b>	<b>CDFD 1.0</b>
1,5 mm <sup>2</sup> AWG 16 identification No. 4		<b>CDFA 1.5</b>	<b>CDFD 1.5</b>
2,5 mm <sup>2</sup> AWG 14 identification No. 5		<b>CDFA 2.5</b>	<b>CDFD 2.5</b>
10A male contacts			
0,14-0,37 mm <sup>2</sup> AWG 26-22 identification No. 1		<b>CDMA 0.3</b>	<b>CDMD 0.3</b>
0,5 mm <sup>2</sup> AWG 20 identification No. 2		<b>CDMA 0.5</b>	<b>CDMD 0.5</b>
0,75 mm <sup>2</sup> AWG 18 identification No. ②		<b>CDMA 0.7</b>	<b>CDMD 0.7</b>
1 mm <sup>2</sup> AWG 18 identification No. 3		<b>CDMA 1.0</b>	<b>CDMD 1.0</b>
1,5 mm <sup>2</sup> AWG 16 identification No. 4		<b>CDMA 1.5</b>	<b>CDMD 1.5</b>
2,5 mm <sup>2</sup> AWG 14 identification No. 5		<b>CDMA 2.5</b>	<b>CDMD 2.5</b>

- characteristics according to EN 61984:

### 10A 250V 4kV 2

- certified
- rated voltage according to UL/CSA: 600V
- insulation resistance: ≥ 10 GΩ
- ambient temperature limit: -40 °C ... +125 °C
- made of self-extinguishing thermoplastic resin UL 94V-0
- mechanical life: ≥ 500 cycles
- contact resistance: ≤ 3 mΩ
- for applications requiring higher voltages, please see the special voltage application section on page 75
- **it is recommended to crimp the contacts with crimping tools homologated by ILME** (please see the crimping tool section 10A contacts, CDF and CDM series on pages 705 - 741)
- for max. current load see the connector inserts derating diagram below; for more information see page 28

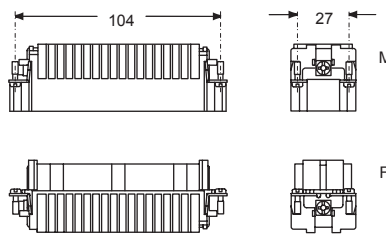

contacts side (front view)

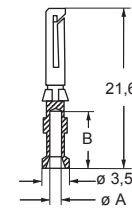
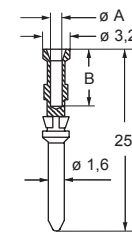
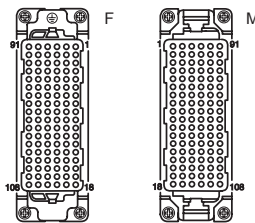

### CDF and CDM contacts

conductor section mm <sup>2</sup>	conductor slot ø A (mm)	conductors stripping length B (mm)
0,14-0,37	0,9	8
0,5	1,1	8
0,75	1,3	8
1,0	1,45	8
1,5	1,8	8
2,5	2,2	6

### CDD 108 poles connector inserts Maximum current load derating diagram

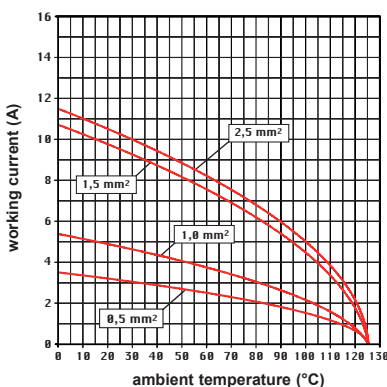

CR CP coding pin with loss of one contact (page 689)



+ for basic or high thickness gold plating, please refer to page 674

# CDD 144 poles + ⊕ 10A - 250V

enclosures:  
size "77.62"

page:

C-TYPE IP65/IP66  
W-TYPE for aggressive environments  
E-Xtreme® corrosion proof

424 - 429  
525  
546

## inserts, crimp connections

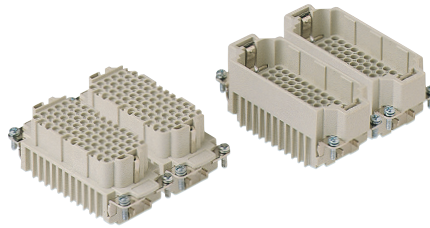

## 10A crimp contacts silver and gold plated



PCBs interface, see article CIF 2.4 on page 670

description	part No.	part No.	part No.	part No.
without contacts (to be ordered separately)				
female inserts, No. (1-72) and (73-144)				
male inserts, No. (1-72) and (73-144)				
10A female contacts				
0,14-0,37 mm <sup>2</sup> AWG 26-22 identification No. 1	<b>CDDF 72</b>	<b>CDDF 72 N</b>	<b>silver plated</b>	<b>gold plated+</b>
0,5 mm <sup>2</sup> AWG 20 identification No. 2				
0,75 mm <sup>2</sup> AWG 18 identification No. ②				
1 mm <sup>2</sup> AWG 18 identification No. 3				
1,5 mm <sup>2</sup> AWG 16 identification No. 4				
2,5 mm <sup>2</sup> AWG 14 identification No. 5				
10A male contacts				
0,14-0,37 mm <sup>2</sup> AWG 26-22 identification No. 1	<b>CDDM 72</b>	<b>CDDM 72 N</b>	<b>silver plated</b>	<b>gold plated+</b>
0,5 mm <sup>2</sup> AWG 20 identification No. 2				
0,75 mm <sup>2</sup> AWG 18 identification No. ②				
1 mm <sup>2</sup> AWG 18 identification No. 3				
1,5 mm <sup>2</sup> AWG 16 identification No. 4				
2,5 mm <sup>2</sup> AWG 14 identification No. 5				
CDFA 0.3			<b>CDFD 0.3</b>	
CDFA 0.5			<b>CDFD 0.5</b>	
CDFA 0.7			<b>CDFD 0.7</b>	
CDFA 1.0			<b>CDFD 1.0</b>	
CDFA 1.5			<b>CDFD 1.5</b>	
CDFA 2.5			<b>CDFD 2.5</b>	
CDMA 0.3			<b>CDMD 0.3</b>	
CDMA 0.5			<b>CDMD 0.5</b>	
CDMA 0.7			<b>CDMD 0.7</b>	
CDMA 1.0			<b>CDMD 1.0</b>	
CDMA 1.5			<b>CDMD 1.5</b>	
CDMA 2.5			<b>CDMD 2.5</b>	

- characteristics according to EN 61984:

### 10A 250V 4kV 2

- certified
- rated voltage according to UL/CSA: 600V
- insulation resistance: ≥ 10 GΩ
- ambient temperature limit: -40 °C ... +125 °C
- made of self-extinguishing thermoplastic resin UL 94V-0
- mechanical life: ≥ 500 cycles
- contact resistance: ≤ 3 mΩ
- for applications requiring higher voltages, please see the special voltage application section on page 75
- **it is recommended to crimp the contacts with crimping tools homologated by ILME** (please see the crimping tool section 10A contacts, CDF and CDM series on pages 705 - 741)
- for max. current load see the connector inserts derating diagram below; for more information see page 28

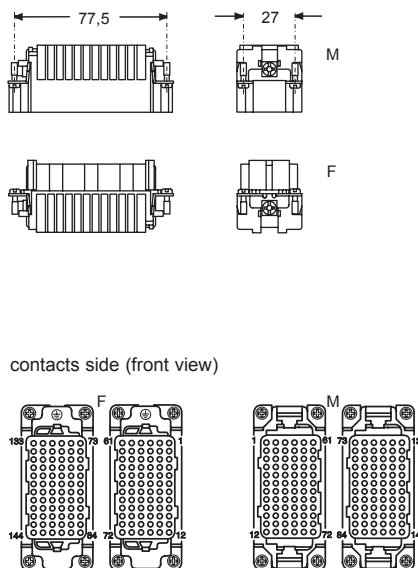

contacts side (front view)

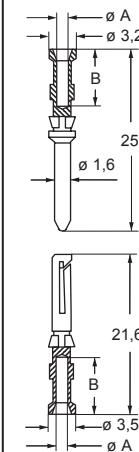

### CDF and CDM contacts

conductor section mm <sup>2</sup>	conductor slot Ø A (mm)	conductors stripping length B (mm)
0,14-0,37	0,9	8
0,5	1,1	8
0,75	1,3	8
1,0	1,45	8
1,5	1,8	8
2,5	2,2	6

† for basic or high thickness gold plating, please refer to page 674

CDD 144 poles connector inserts  
Maximum current load derating diagram

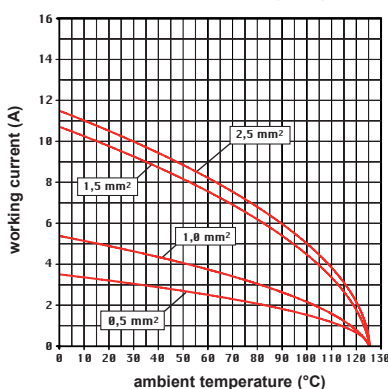

CR CP coding pin with loss of one contact (page 689)



# CDD 216 poles + ⊕ 10A - 250V

enclosures:  
size "104.62"

page:

C-TYPE IP65/IP66  
W-TYPE for aggressive environments  
E-Xtreme® corrosion proof

430  
526  
547

## inserts, crimp connections

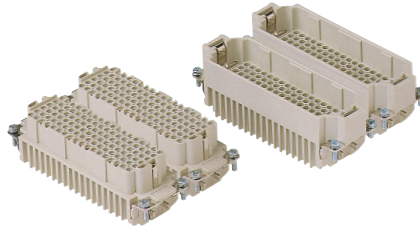

## 10A crimp contacts silver and gold plated



PCBs interface, see article CIF 2.4 on page 670

description	part No.	part No.	part No.	part No.
without contacts (to be ordered separately)				
female inserts, No. (1-108) and (109-216)	<b>CDDF 108</b>	<b>CDDF 108 N</b>		
male inserts, No. (1-108) and (109-216)	<b>CDDM 108</b>	<b>CDDM 108 N</b>		
10A female contacts				
0,14-0,37 mm <sup>2</sup> AWG 26-22 identification No. 1			<b>CDFA 0.3</b>	<b>CDFD 0.3</b>
0,5 mm <sup>2</sup> AWG 20 identification No. 2			<b>CDFA 0.5</b>	<b>CDFD 0.5</b>
0,75 mm <sup>2</sup> AWG 18 identification No. ②			<b>CDFA 0.7</b>	<b>CDFD 0.7</b>
1 mm <sup>2</sup> AWG 18 identification No. 3			<b>CDFA 1.0</b>	<b>CDFD 1.0</b>
1,5 mm <sup>2</sup> AWG 16 identification No. 4			<b>CDFA 1.5</b>	<b>CDFD 1.5</b>
2,5 mm <sup>2</sup> AWG 14 identification No. 5			<b>CDFA 2.5</b>	<b>CDFD 2.5</b>
10A male contacts				
0,14-0,37 mm <sup>2</sup> AWG 26-22 identification No. 1			<b>CDMA 0.3</b>	<b>CDMD 0.3</b>
0,5 mm <sup>2</sup> AWG 20 identification No. 2			<b>CDMA 0.5</b>	<b>CDMD 0.5</b>
0,75 mm <sup>2</sup> AWG 18 identification No. ②			<b>CDMA 0.7</b>	<b>CDMD 0.7</b>
1 mm <sup>2</sup> AWG 18 identification No. 3			<b>CDMA 1.0</b>	<b>CDMD 1.0</b>
1,5 mm <sup>2</sup> AWG 16 identification No. 4			<b>CDMA 1.5</b>	<b>CDMD 1.5</b>
2,5 mm <sup>2</sup> AWG 14 identification No. 5			<b>CDMA 2.5</b>	<b>CDMD 2.5</b>

- characteristics according to EN 61984:

### 10A 250V 4kV 2

- certified
- rated voltage according to UL/CSA: 600V
- insulation resistance: ≥ 10 GΩ
- ambient temperature limit: -40 °C ... +125 °C
- made of self-extinguishing thermoplastic resin UL 94V-0
- mechanical life: ≥ 500 cycles
- contact resistance: ≤ 3 mΩ
- for applications requiring higher voltages, please see the special voltage application section on page 75
- **it is recommended to crimp the contacts with crimping tools homologated by ILME** (please see the crimping tool section 10A contacts, CDF and CDM series on pages 705 - 741)
- for max. current load see the connector inserts derating diagram below; for more information see page 28

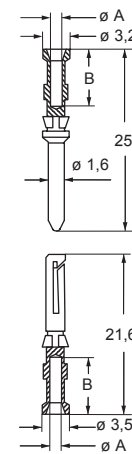
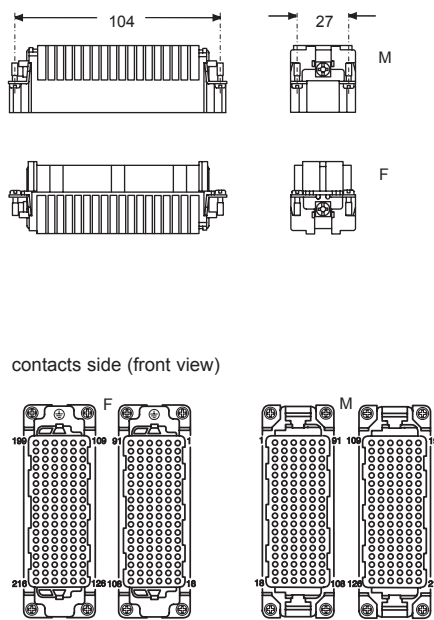

### CDF and CDM contacts

conductor section mm <sup>2</sup>	conductor slot ø A (mm)	conductors stripping length B (mm)
0,14-0,37	0,9	8
0,5	1,1	8
0,75	1,3	8
1,0	1,45	8
1,5	1,8	8
2,5	2,2	6

### CDD 108 poles connector inserts Maximum current load derating diagram

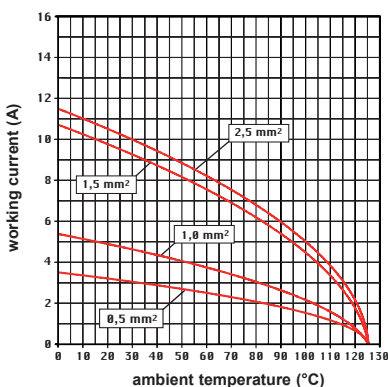

CR CP coding pin with loss of one contact (page 689)



+ for basic or high thickness gold plating, please refer to page 674

# CDSH-SQUICH® series

## High density without tools (spring connection contacts)

The CDSH-SQUICH® series (with spring and actuator button) are the logical **evolution of the CDS series**.

The continuous demand for a greater number of poles and smaller dimensions has led to the design and manufacture of the new CDSH series, which offers single connectors with a **maximum number of 84 poles** that occupy the **same space of standard connectors** with screw/spring connection.

**Each of the spring terminals has an actuator button**, suitably shaped and incorporated in the cavity. When this button is pushed, it triggers the closure of the spring device of the corresponding terminal, safely and reliably connecting the conductor to its respective electric contact in the connector.

The actuator buttons are supplied raised, in the "open terminal" position and are **easily distinguishable by the orange colour** which makes them stand out from the insulating body of the connector.

The advantage of this exclusive solution is that **the actuators disappear completely within the body of the connector**, making it easy to identify terminals not yet closed and **eliminating possible obstacles** to the movement of the conductors during installation and maintenance.

SQUICH® technology requires no tools **to activate the terminal and a simple operation is all you need to make the connection**. Refer to SQUICH® Connection operating principles on page 24.

It is possible to insert in the mating area the new **CR CDS plastic coding pin** that enables the polarisation of inserts in a wide range of combinations. This means that it is possible to install side by side identical connectors with different functions.



The CR CDS coding pins **can also be used in combination with CR 20 / CRM / CRF / CR 72 metal pins** instead of insert fixing screws in order to increase the number of possible combinations. Each position of the coding pin used on the female insert must correspond to an unused position on the male insert.

The required number of coding pins, depending on the size of connectors, and the maximum number of possible codings is shown in the table 1.

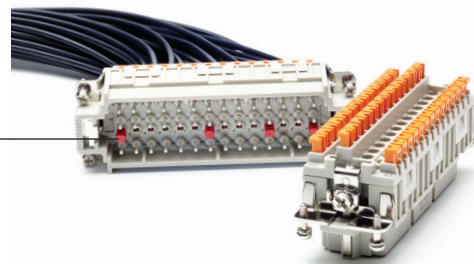

### SUM UP

- ☑ **Greater pole density as compared to existing connector with screw terminals.**  
**SAVE SPACE +70%**
- ☑ **Reduced wiring time.**  
**SAVE TIME -50%**

STANDARD	CDSH - HIGH DENSITY	
16A	10A	
06 poles	09 poles	+50%
10 poles	18 poles	+80%
16 poles	27 poles	+70%
24 poles	42 poles	+75%
32 poles	54 poles	+70%
48 poles	84 poles	+75%

- ☑ **Wiring tool is not necessary**
- ☑ **Quick identification of wired and non-wired terminals**
- ☑ **Terminals already open and ready for conductor clamping**
- ☑ **Option to use wires up to 2,5 mm<sup>2</sup>**
- ☑ **Built-in silver plated contacts**
- ☑ **Excellent fastening solution**
- ☑ **Great resistance to strong vibration**

**Q CDSH series can be used with the whole range of ILME enclosures**

**Table 1. CDSH series - Coding with CR CDS pins**

Size of connectors	Slots for coding pins (M) = male insert (F) = female insert	Required coding pins for each coupling	Possible codings
9P + ⊕	3 (M) + 3 (F)	3 2 (M) + 1 (F)	3
18P + ⊕	6 (M) + 6 (F)	6 3 (M) + 3 (F)	20
27P + ⊕	9 (M) + 9 (F)	9 5 (M) + 4 (F)	126
42P + ⊕	14 (M) + 14 (F)	14 7 (M) + 7 (F)	3.432

# CDSH-SQUICH® series

## TECHNICAL FEATURES

Insert series		CDSH-SQUICH®
No. of poles <sup>1)</sup>	Main contacts + ⊕	<b>9, 18, 27, 42, [54], [84]</b>
	auxiliary contacts	—
Rated current <sup>2)</sup>		10A
EN IEC 61984	rated voltage	400V
	rated impulse voltage	6kV
	<b>pollution degree</b>	<b>3</b>
EN IEC 61984	rated voltage	4000V / 690V
	rated impulse voltage	6kW
	<b>pollution degree</b>	<b>2</b>
Contact resistance		≤ 1 mΩ
Insulation resistance		≥ 10 GΩ
Ambient temperature limit (°C)	min	-40
	max	+125
Degree of protection	with enclosures (according to type)	IP65, IP66, IP67, IP68, IP69
	without enclosures	IP20
Conductor connections		spring type with actuator button
Conductor cross-sectional area	mm <sup>2</sup>	0,14 - 2,5 (for wires with crimped ferrule, usable section: up to 1,5 mm <sup>2</sup> )
	AWG	26 - 14 (AWG 16 with crimped ferrule) 26 - 16 prepared with crimped ferrule
Mechanical endurance (mating cycles)		≥ 500

1) Polarities shown in brackets may be achieved by using two inserts in their own double sized housings.

2) Please check the insert load curves to establish the actual maximum operating current according to the ambient temperature.

### SQUICH® Connection technology

In the layout below the wires are connected to the socket and plug insert contacts by means of a spring terminal with actuator button.

**This type of connection offers the following advantages:**

- no special wire preparation (other than stripping);
- it offers an excellent fastening solution and a great resistance to strong vibrations;
- it allows the use of solid and flexible wires with cross-sections between 0,14 and 2,5 mm<sup>2</sup> (AWG 26 - 14);
- for wires with crimped ferrule, usable section: to 1,5 mm<sup>2</sup> (AWG 16);
- a screwdriver with a 0,5 x 3,5 mm blade is the only tool required to remove the wire from the contact;
- the profile of the actuator button allows the section of a test probe.

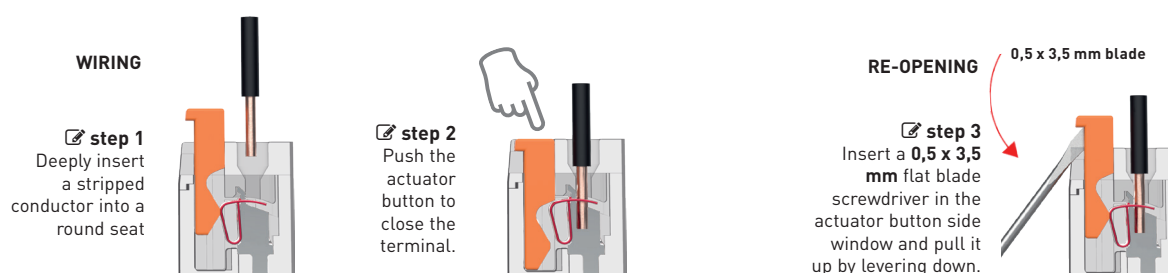

# CDSH-SQUICH® 9 poles + ⊕ 10A - 400V

enclosures: size "44.27"	page:
C-TYPE IP65/IP66	387 - 392
C7 IP67, single lever	436 - 437
V-TYPE IP65/IP66, single lever	444 - 447
BIG hoods	466 - 467
T-TYPE IP65 insulating	480 - 481
T-TYPE / W IP66 insulating	489
HYGIENIC T-TYPE / H IP66/IP69	501
HYGIENIC T-TYPE / C IP66/IP69, -50 °C	506
W-TYPE for aggressive environments	521
E-Xtreme® corrosion proof	530 - 531, 542, 550 - 551
EMC	578
Central lever	603 - 605
LS-TYPE	618 - 619
IP68	632 - 635
panel supports: COB	page: 652 - 653

inserts,  
spring terminal connections without tools

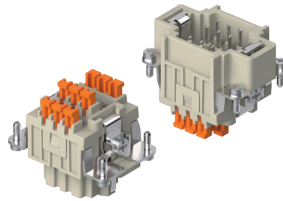

coding pins



description	part No.	part No.
-------------	----------	----------

spring terminals with actuator button  
female inserts with female contacts  
male inserts with male contacts

CDSHF 09  
CDSHM 09

plastic coding pins

CR CDS

- characteristics according to EN 61984:  
**10A 400V 6kV 3**  
**10A 400V/690V 6kV 2**
- certified
- insulation resistance:  $\geq 10 \text{ G}\Omega$
- ambient temperature limit:  $-40 \text{ }^\circ\text{C} \dots +125 \text{ }^\circ\text{C}$
- made of self-extinguishing thermoplastic resin  
UL 94V-0
- mechanical life:  $\geq 500$  cycles
- contact resistance:  $\leq 1 \text{ m}\Omega$
- for max. current load see the connector inserts derating diagram below; for more information see page 28

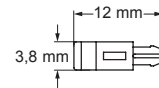
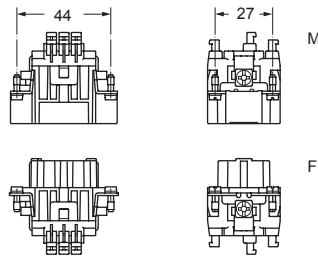

contacts side (front view)

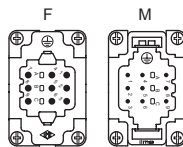

- inserts for conductors cross-sectional areas:  
0,14 - 2,5 mm<sup>2</sup> - AWG 26 - 14
- for wires with crimped ferrule, usable section:  
up to 1,5 mm<sup>2</sup> (AWG 16)
- conductors stripping length: 9...11 mm

### SQUICH®-spring connection technology WIRING

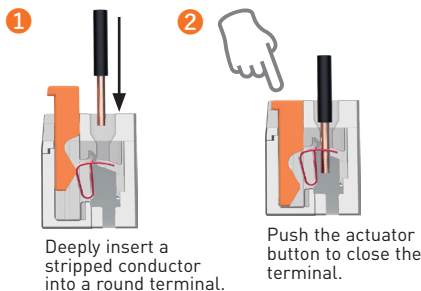

### RE-OPENING

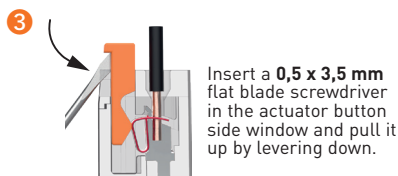

CDSH 09 poles connector inserts  
Maximum current load derating diagram

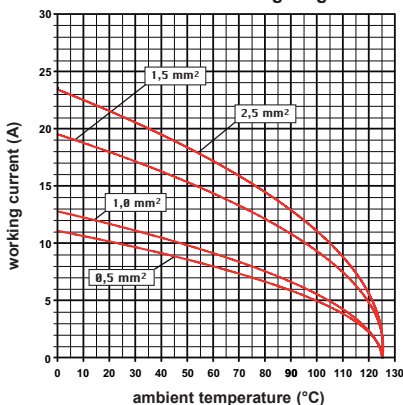

CDSH-SQUICH®



# CDSH-SQUICH® 18 poles + ⊕ 10A - 400V

enclosures: size "57.27"	page:
C-TYPE IP65/IP66	393 - 401
C7 IP67, two levers	438
V-TYPE IP65/IP66, single lever	448 - 453
BIG hoods	468 - 469
T-TYPE IP65 insulating	482 - 483
T-TYPE / W IP66 insulating	490
HYGIENIC T-TYPE / H IP66/IP69	502
HYGIENIC T-TYPE / C IP66/IP69, -50 °C	507
W-TYPE for aggressive environments	522
E-Xtreme® corrosion proof	532 - 533, 543, 552 - 553
EMC	579
Central lever	606 - 608
LS-TYPE	620 - 621
IP68	636 - 639
panel supports:	page:
COB	652 - 653

## inserts, spring terminal connections without tools

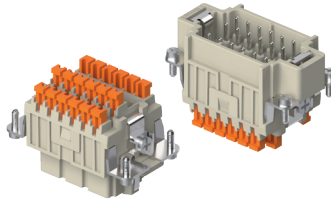

## coding pins



description	part No.	part No.
-------------	----------	----------

spring terminals with actuator button  
female inserts with female contacts  
male inserts with male contacts

**CDSHF 18**  
**CDSHM 18**

plastic coding pins

**CR CDS**

- characteristics according to EN 61984:  
**10A 400V 6kV 3**  
**10A 400V/690V 6kV 2**
- certified
- insulation resistance:  $\geq 10 \text{ G}\Omega$
- ambient temperature limit:  $-40 \text{ }^\circ\text{C} \dots +125 \text{ }^\circ\text{C}$
- made of self-extinguishing thermoplastic resin  
UL 94V-0
- mechanical life:  $\geq 500$  cycles
- contact resistance:  $\leq 1 \text{ m}\Omega$
- for max. current load see the connector inserts derating diagram below; for more information see page 28

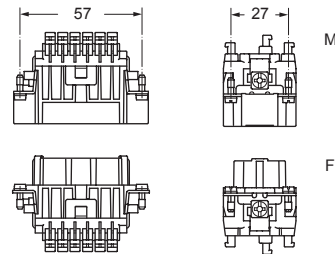

contacts side (front view)

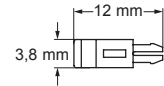
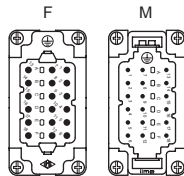

- inserts for conductors cross-sectional areas:  
0,14 - 2,5 mm<sup>2</sup> - AWG 26 - 14
- for wires with crimped ferrule, usable section:  
up to 1,5 mm<sup>2</sup> (AWG 16)
- conductors stripping length: 9...11 mm

### SQUICH®-spring connection technology WIRING

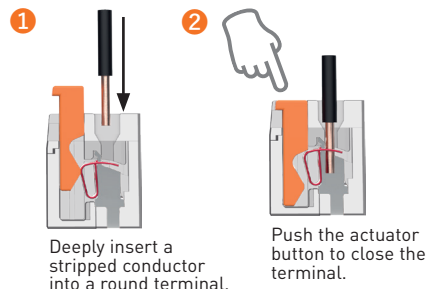

### RE-OPENING

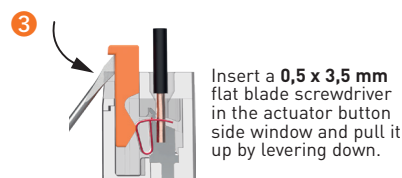

**CDSH 18 poles connector inserts**  
**Maximum current load derating diagram**

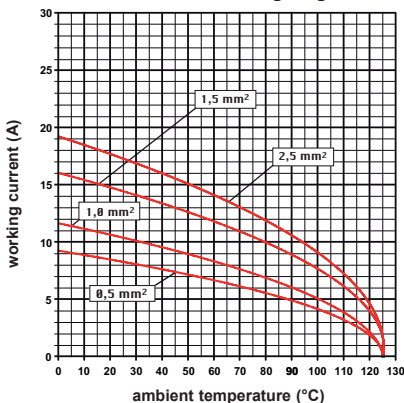

# CDSH-SQUICH® 27 poles + ⊕ 10A - 400V

enclosures: size "77.27"	page:
C-TYPE IP65/IP66	402 - 411
C7 IP67, two levers	439 - 440
V-TYPE IP65/IP66, single lever	454 - 458
BIG hoods	470 - 471
T-TYPE IP65 insulating	484 - 485
T-TYPE / W IP66 insulating	491
HYGIENIC T-TYPE / H IP66/IP69	503
HYGIENIC T-TYPE / C IP66/IP69, -50 °C	508
W-TYPE for aggressive environments	523
E-Xtreme® corrosion proof	534 - 535, 544, 554 - 555
EMC	580
Central lever	609 - 611
LS-TYPE	622 - 623
IP68	640 - 643
panel supports: COB	page: 652 - 653

## inserts, spring terminal connections without tools

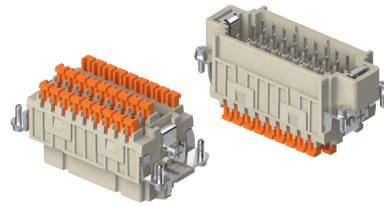

## coding pins



description	part No.	part No.
-------------	----------	----------

spring terminals with actuator button  
female inserts with female contacts  
male inserts with male contacts

CDSHF 27  
CDSHM 27

plastic coding pins

CR CDS

- characteristics according to EN 61984:  
**10A 400V 6kV 3**  
**10A 400V/690V 6kV 2**
- certified
- insulation resistance:  $\geq 10 \text{ G}\Omega$
- ambient temperature limit:  $-40 \text{ }^\circ\text{C} \dots +125 \text{ }^\circ\text{C}$
- made of self-extinguishing thermoplastic resin  
UL 94V-0
- mechanical life:  $\geq 500$  cycles
- contact resistance:  $\leq 1 \text{ m}\Omega$
- for max. current load see the connector inserts derating diagram below; for more information see page 28

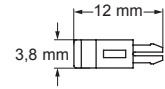
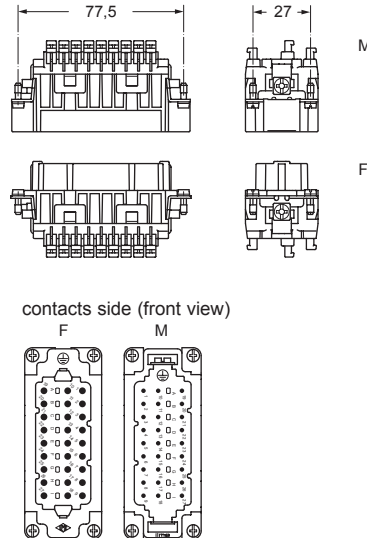

- inserts for conductors cross-sectional areas:  
0,14 - 2,5 mm<sup>2</sup> - AWG 26 - 14
- for wires with crimped ferrule, usable section:  
up to 1,5 mm<sup>2</sup> (AWG 16)
- conductors stripping length: 9...11 mm

### SQUICH®-spring connection technology WIRING

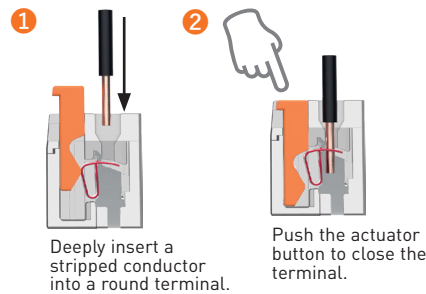

### RE-OPENING

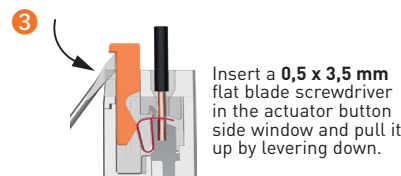

CDSH 27 poles connector inserts  
Maximum current load derating diagram

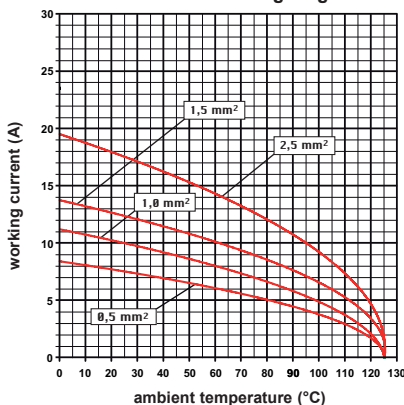

CDSH-SQUICH®

enclosures: size "104.27"	page:
C-TYPE IP65/IP66	412 - 423
C7 IP67, two levers	441 - 442
V-TYPE IP65/IP66, single lever	459 - 463
BIG hoods	472 - 473
T-TYPE IP65 insulating	486 - 487
T-TYPE / W IP66 insulating	492
HYGIENIC T-TYPE / H IP66/IP69	504
HYGIENIC T-TYPE / C IP66/IP69, -50 °C	509
W-TYPE for aggressive environments	524
E-Xtreme® corrosion proof	536 - 537, 545, 556 - 557
EMC	581
Central lever	612 - 614
LS-TYPE	624 - 625
IP68	644 - 647
panel supports:	page:
COB	652 - 653

**inserts,  
spring terminal connections without tools**

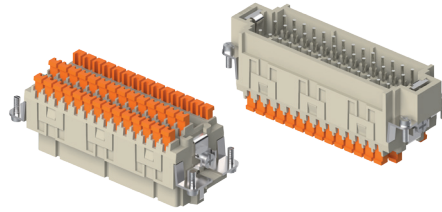

**coding pins**



description	part No.	part No.
spring terminals with actuator button	<b>CDSHF 42</b>	
female inserts with female contacts	<b>CDSHM 42</b>	
male inserts with male contacts		
plastic coding pins		<b>CR CDS</b>

- characteristics according to EN 61984:  
**10A 400V 6kV 3**  
**10A 400V/690V 6kV 2**
- certified
- insulation resistance:  $\geq 10 \text{ G}\Omega$
- ambient temperature limit:  $-40 \text{ }^\circ\text{C} \dots +125 \text{ }^\circ\text{C}$
- made of self-extinguishing thermoplastic resin  
UL 94V-0
- mechanical life:  $\geq 500$  cycles
- contact resistance:  $\leq 1 \text{ m}\Omega$
- for max. current load see the connector inserts derating diagram below; for more information see page 28

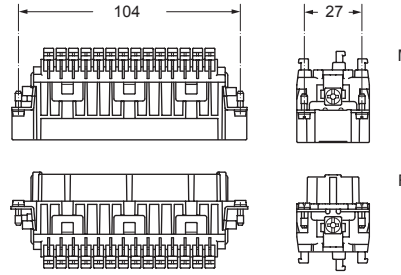

contacts side (front view)

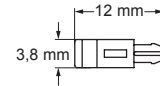
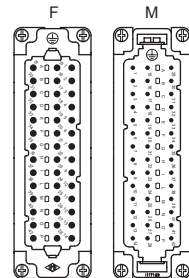

- inserts for conductors cross-sectional areas:  
0,14 - 2,5 mm<sup>2</sup> - AWG 26 - 14
- for wires with crimped ferrule, usable section:  
up to 1,5 mm<sup>2</sup> (AWG 16)
- conductors stripping length: 9...11 mm

**SQUICH®-spring connection technology  
WIRING**

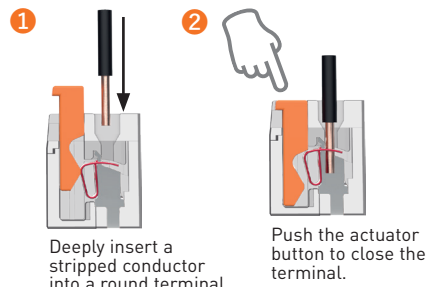

**RE-OPENING**

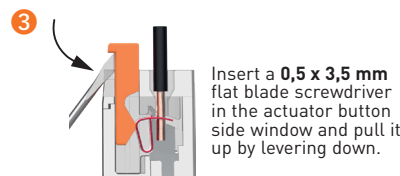

**CDSH 42 poles connector inserts  
Maximum current load derating diagram**

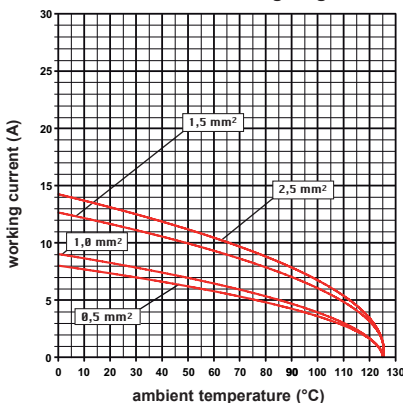

# CDSH-SQUICH® 54 poles + ⊕ 10A - 400V

enclosures:  
size "77.62"

page:

C-TYPE IP65/IP66  
W-TYPE for aggressive environments  
E-Xtreme® corrosion proof

424 - 429  
525  
546

inserts,  
spring terminal connections without tools

coding pins

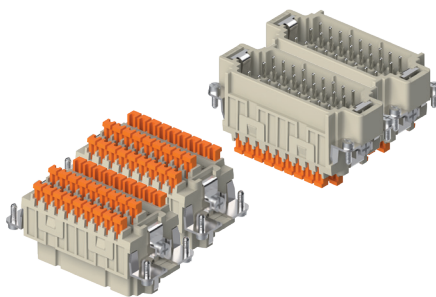

description

part No.

part No.

part No.

spring terminals with actuator button  
female inserts with female contacts, No. (1-27) and (28-54)  
male inserts with male contacts, No. (1+27) and (28-54)

CDSHF 27  
CDSHM 27

CDSHF 27 N  
CDSHM 27 N

plastic coding pins

CR CDS

- characteristics according to EN 61984:

**10A 400V 6kV 3**  
**10A 400V/690V 6kV 2**

- certified

- insulation resistance:  $\geq 10 \text{ G}\Omega$

- ambient temperature limit:  $-40 \text{ }^\circ\text{C} \dots +125 \text{ }^\circ\text{C}$

- made of self-extinguishing thermoplastic resin  
UL 94V-0

- mechanical life:  $\geq 500$  cycles

- contact resistance:  $\leq 1 \text{ m}\Omega$

- for max. current load see the connector inserts derating diagram below; for more information see page 28

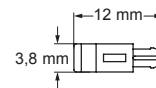
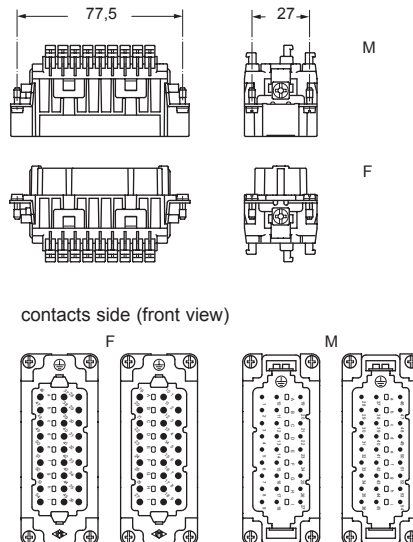

contacts side (front view)

- inserts for conductors cross-sectional areas: 0,14 - 2,5 mm<sup>2</sup> - AWG 26 - 14
- for wires with crimped ferrule, usable section: up to 1,5 mm<sup>2</sup> (AWG 16)
- conductors stripping length: 9...11 mm

**SQUICH®-spring connection technology**

**WIRING**

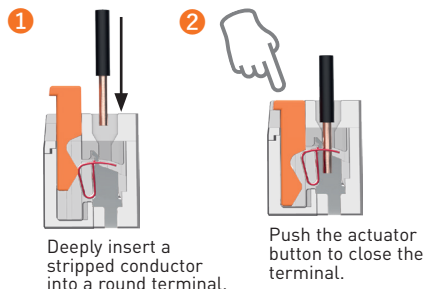

**RE-OPENING**

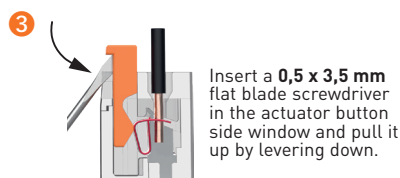

CDSH 54 poles connector inserts  
Maximum current load derating diagram

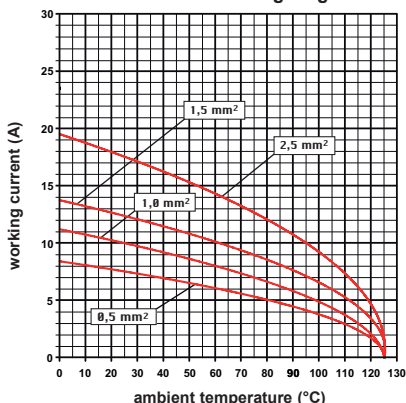

# CDSH-SQUICH® 84 poles + ⊕ 10A - 400V

enclosures:  
size "104.62"

page:

C-TYPE IP65/IP66  
W-TYPE for aggressive environments  
E-Xtreme® corrosion proof

430  
526  
547

## inserts, spring terminal connections without tools

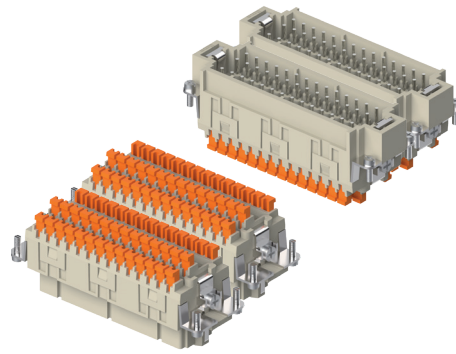

## coding pins



description	part No.	part No.	part No.
spring terminals with actuator button			
female inserts with female contacts, No. (1-42) and (43-84)	<b>CDSHF 42</b>	<b>CDSHF 42 N</b>	
male inserts with male contacts, No. (1-42) and (43-84)	<b>CDSHM 42</b>	<b>CDSHM 42 N</b>	
plastic coding pins			<b>CR CDS</b>

- characteristics according to EN 61984:

**10A 400V 6kV 3**  
**10A 400V/690V 6kV 2**

certified

- insulation resistance:  $\geq 10 \text{ G}\Omega$
- ambient temperature limit:  $-40 \text{ }^\circ\text{C} \dots +125 \text{ }^\circ\text{C}$
- made of self-extinguishing thermoplastic resin UL 94V-0
- mechanical life:  $\geq 500$  cycles
- contact resistance:  $\leq 1 \text{ m}\Omega$
- for max. current load see the connector inserts derating diagram below; for more information see page 28

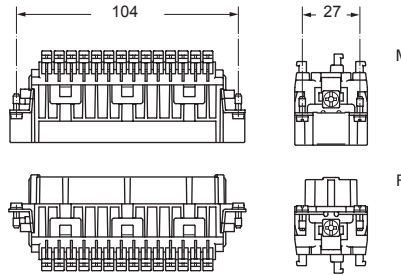

contacts side (front view)

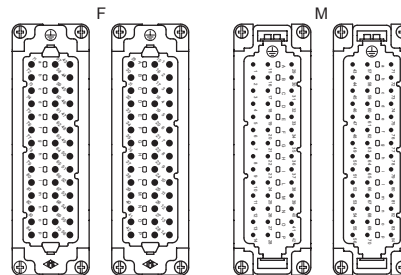

- inserts for conductors cross-sectional areas: 0,14 - 2,5 mm<sup>2</sup> - AWG 26 - 14
- for wires with crimped ferrule, usable section: up to 1,5 mm<sup>2</sup> (AWG 16)
- conductors stripping length: 9...11 mm

### SQUICH®-spring connection technology

#### WIRING

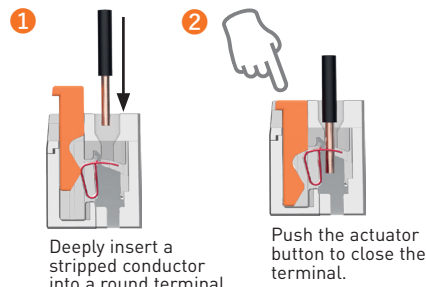

#### RE-OPENING

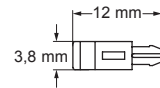
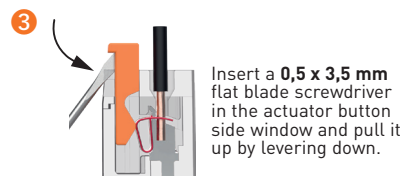

CDSH 84 poles connector inserts  
Maximum current load derating diagram

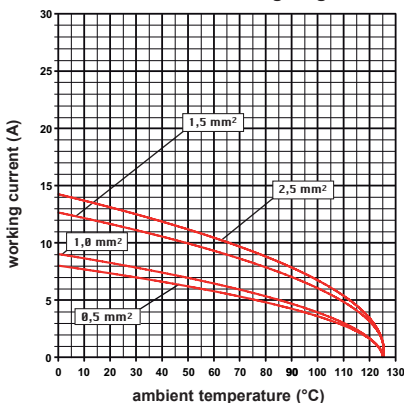

## CDSH NC-SQUICH® series

### 3 contact pairs with an AutoShort NC contact element

ILME developed an **innovative connector suitable for interfacing measuring current transformers (CTs)** with the dedicated electronic measurement processing equipment. Use of such systems is increasing in transformer substations with the diffusion of smart grid concepts due to the growth of self-standing power generation plants (photovoltaic, wind).

The CDSH...NC connector has the **same dimensions of a 6 poles size "44.27" CSH connector**, and it is **easy to wire** thanks to ILME proprietary SQUICH® tool-less quick connection technology.

Inside the female insert, for each of the three contact pairs 1-2, 3-4 and 5-6, a **suitable spring element is foreseen**, providing a NC (normally closed) contact between the female contact pair. The said short-circuit element automatically establishes a short-circuit between the female contact pair while the connector is being unmated, before the complete withdrawal of the corresponding male connector.

This protects the measuring current transformer's secondary windings to which this connector is deemed to be wired, against the high voltage that would arise if the ends of each winding were left open while the primary winding (the power line busbars) are still under load.

#### AUTOSHORT NC Operating principles

**CDSH...NC** connector can be used only for connecting up to three secondary (output) windings of measuring current transformers to specific measuring circuits; on the female side each contact pair is provided with said AutoShort NC contact element ① to keep the secondary winding ends shorted while the female connector is not engaged with the male connector, thus avoiding damages to the insulation of the current transformer and consequent hazardous condition for the personnel operating the unmating of the connector while the power busbars are energized. When the female and male connectors are being mated ②, the short-circuit is released after proper electrical engagement of the two connector halves, thus allowing again current measurement by the dedicated electronic measurement processing equipment wired on the male connector side.

The new connector inserts can be used in size "44.27" connector enclosures, either metal (conductive) or thermoplastics (insulating), with up to IP68 degree of protection (IP66/IP68 with series CG/MG), within enclosures for aggressive environments (series "W") or with up to IP66/IP69 within series T-TYPE HYGIENIC enclosures for hygienic applications.

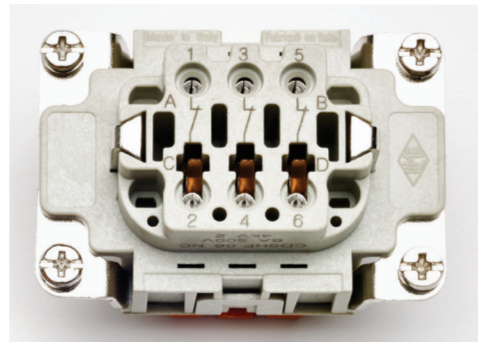

During the mating of these specially designed connector inserts, three corresponding actuator buttons realized on the mating face of the male connector, once the male contacts are already engaged with the corresponding female contacts, push aside the facing end of the AutoShort NC contact element, in order to release the short-circuit previously provided. In mated condition the proper termination of the secondary windings of the CT must be provided by the customer's downstream circuit, e.g. by suitable resistors.

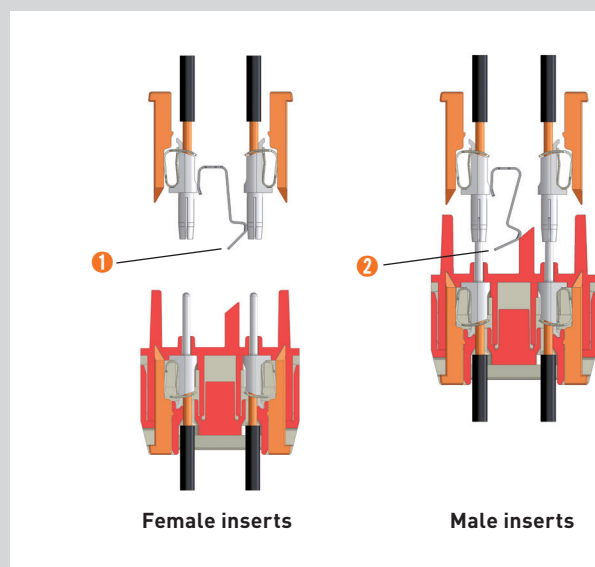



## AUTOSHORT NC Coding pins

Optionally, it is possible to add **four special coding pins CR CDS** that allow up to 6 different codings, by installing 2 coding pins on the male connector half and correspondingly 2 on the female connector half, according to the coding scheme provided in the following:

### CODING SCHEME

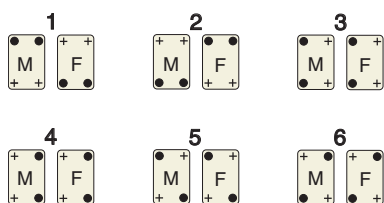

### Legend

- = coding pin installed
- + = no coding pin

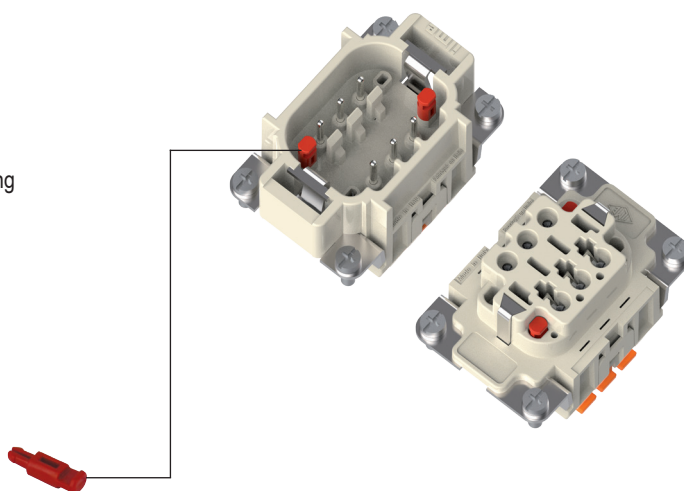

The CR CDS coding pins can also be used in combination with other CR 20 / CRM / CRF / CR 72 metal pins instead of insert fixing screws in order to increase the number of possible combinations.

## AUTOSHORT NC PIN Assignment

Female inserts with NC shorting contacts between contacts of pairs 1-2, 3-4, 5-6, opening upon with male inserts.  
Pin assignment of contacts for the connector is the following:

Pin	Assignment
1	Winding 1 start
2	Winding 1 end
3	Winding 2 start
4	Winding 2 end
5	Winding 3 start
6	Winding 3 end
PE	⊕ Protective Earth

### View from the contact side

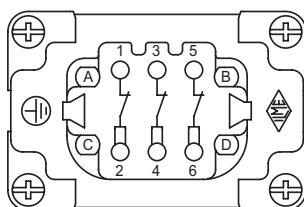

Female

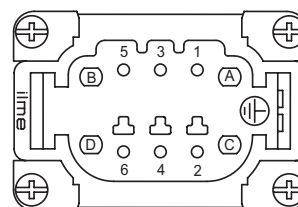

Male

## CDSH NC-SQUICH® series

### TECHNICAL FEATURES

Insert series	CDSH NC-SQUICH®
Electrical contacts	6 spring clamp type built-in contacts with actuator (SQUICH®) made by copper alloy, silver plated
Rated current	<b>6A 250V 4kV 3; 6A 500V 4kV 2</b> according to EN 61984 Fault condition (rated short time thermal current): 50A for 1 s
Contact resistance (connector mated)	≤ 3 mΩ
Insulation resistance	≥ 10 GΩ
Ambient temperature limit (°C)	min. -40 max. +125
Degree of protection	IP20 (connector without housing), IP65 or IP66 (connectors in T-TYPE housings), IP66 or more (connectors in ILME metal housings)
Conductor connections	3 pairs of contacts (with autoshunt on each pair of female connector), plus protective earth, size 44.27 housings
Conductor cross-sectional area	0,14 - 2,5 mm <sup>2</sup> (AWG 26 - 14) for solid or unprepared stranded copperwires 0,14 - 1,5 mm <sup>2</sup> (AWG 26 - 16) for stranded copper wires prepared with ferrules
Flammability	94V-0 according to UL 94
Mechanical endurance (mating cycles)	≥ 50

# CDSH NC-SQUICH® 6 poles + ⊕ 6A - 250V

enclosures: size "44.27"	page:
C-TYPE IP65/IP66	387 - 392
C7 IP67, single lever	436 - 437
V-TYPE IP65/IP66, single lever	444 - 447
BIG hoods	466 - 467
T-TYPE IP65 insulating	480 - 481
T-TYPE / W IP66 insulating	489
HYGIENIC T-TYPE / H IP66/IP69	501
HYGIENIC T-TYPE / C IP66/IP69, -50 °C	506
W-TYPE for aggressive environments	521
E-Xtreme® corrosion proof	530 - 531, 542, 550 - 551
EMC	578
Central lever	603 - 605
LS-TYPE	618 - 619
IP68	632 - 635
panel supports: COB	page: 652 - 653

inserts,  
spring clamp connections with actuator  
button, female inserts with NC shorting  
contacts

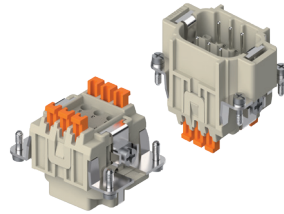

coding pins



**Q SILVER PLATED CONTACTS**

description	part No.	part No
-------------	----------	---------

spring terminals with actuator button  
female inserts with female contacts  
male inserts with male contacts

CDSHF 06 NC  
CDSHM 06 NC

CR CDS

plastic coding pins

- characteristics according to EN 61984:

**6A 250V 4kV 3**  
**6A 500V 4kV 2**  
**10A with connector mated**

- certified

- insulation resistance:  $\geq 10 \text{ G}\Omega$
- ambient temperature limit:  $-40 \text{ }^\circ\text{C} \dots +125 \text{ }^\circ\text{C}$
- made of self-extinguishing thermoplastic resin 94V-0 according to UL 94
- mechanical life:  $\geq 50$  cycles
- contact resistance:  $\leq 3 \text{ m}\Omega$
- NC = Normally Closed
- the diagram below shows the current carrying capacity of the AutoShort female connector unmated, with the three NC contacts shorting the individual circuits wired in series. In this condition the AutoShort connector may be loaded up to 6A. At this max. current it may be wired  $0,75 \text{ mm}^2/18 \text{ AWG}$  to  $2,5 \text{ mm}^2/14 \text{ AWG}$  without significant performance difference.
- For the current-carrying capacity of the mated connector see the relevant diagram (for more information see page 28).

ILME CDSHF/M 06 NC (cross section:  $2,5 \text{ mm}^2$ )

Load curve

Limit Ambient temperature ( $^\circ\text{C}$ )	Working Current (A) $2,5 \text{ mm}^2$
97,2	3,2
108,6	2,4
114,4	2
125	0

CDSH F 06 NC poles connector inserts  
Maximum current load derating diagram

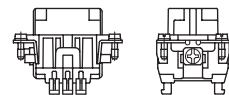
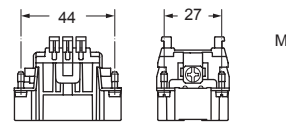
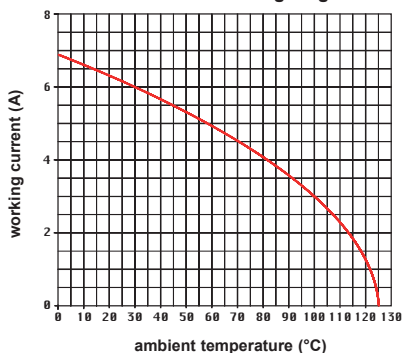

contacts side (front view)

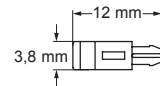
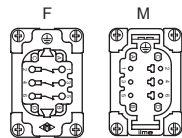

- inserts for conductors section:  
 $0,14 - 2,5 \text{ mm}^2 - \text{AWG } 26 - 14$
- for wires with crimped ferrule, useful cross-section:  
up to  $1,5 \text{ mm}^2$  (AWG 16)
- conductors stripping length:  $9 \dots 11 \text{ mm}$

SQUICH®-spring connection technology

WIRING

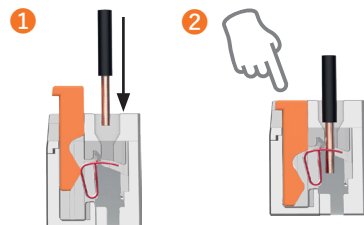

1 Deeply insert a stripped conductor into a round terminal.

2 Push the actuator button to close the terminal.

RE-OPENING

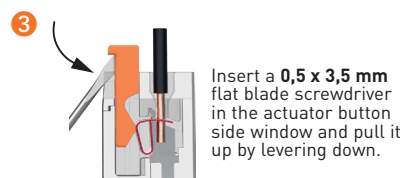

3 Insert a  $0,5 \times 3,5 \text{ mm}$  flat blade screwdriver in the actuator button side window and pull it up by levering down.

## CDA-CDC series

### The compact inserts

#### CDA inserts with screw-type termination

The screw-type connector inserts CDA series with 10 and 16 poles + ⊕ are now made using screw-type terminals (CNE series) with a built-in wire protection pressure plate of proven reliability and practicality.

The wire protection pressure plate preserves the conductors in case of wiring with **unprepared conductors** (i.e. without wire end ferrules) up to a maximum wire cross-section of **4 mm<sup>2</sup>** (12 AWG).

The variant without a wire protection pressure plate (code with suffix X) is also available, for use with **prepared conductors** featuring a wire end ferrule with a maximum usable wire cross-section of **2,5 mm<sup>2</sup>** (14 AWG).

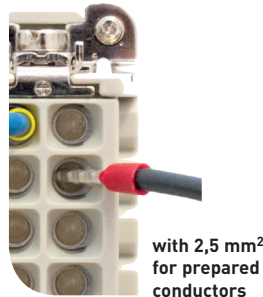
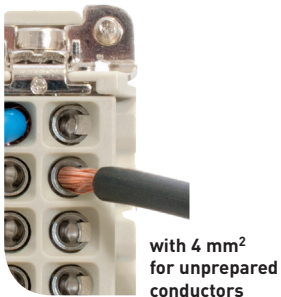

#### CDC inserts with crimp termination

The crimp termination CDC series of inserts with 10 and 16 poles + ⊕ now adopt the tried and tested contact retention technique of connector series CCE and CQE for removable crimp contacts (series CC, max 16A).

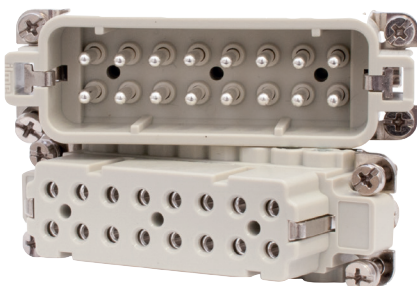

#### CDA-CDC INSERTS SUM-UP

- ☑ According to standard EN 61984:  
16A 250V 4kV 3  
16A 230/400V 4kV 2
- ☑ Insulation resistance:  $\geq 10 \text{ G}\Omega$
- ☑ Ambient temperature limit:  $-40 \text{ }^\circ\text{C} \dots +125 \text{ }^\circ\text{C}$
- ☑ Construction material: UL 94 V-0 self-extinguishing thermoplastic resin
- ☑ Mechanical life:  $\geq 500$  cycles
- ☑ Built-in silver plated contacts (only CDA series)

#### The applications

Like those of the previous series, CDA and CDC inserts and their enclosures are used in accordance with the recommendations EUROMAP 12, EUROMAP 13, EUROMAP 14-1, EUROMAP 16 and EUROMAP 62 (European industry consortium for moulding machines and plastic processing).

The CDC inserts can also be used with CC series crimp contacts made of iron/constantan (Fe-CuNi) for the cabling of J type thermocouples in accordance with IEC/EN 60584-1 (EUROMAP 14-1 recommendation).

The CDA/CDC series inserts can also be coupled with previous insert versions.



# CSAH-SQUICH® series

## Connection without tools, slim version

### CSAH-SQUICH® inserts

To improve high performance industrial connections, ILME has developed and evolved its own spring clamp connectors to meet the market needs and make installation simpler.

**The SQUICH® inserts are adaptable to any type of solid or flexible conductor, including unprepared conductors**

Each of the spring terminals has an actuator button, suitably shaped and incorporated in the cavity. When this button is pressed, it triggers the closure of the spring device of the corresponding terminal, safely and reliably connecting the conductor to its respective electric contact in the connector.

The actuator buttons are supplied raised, in the "open terminal" position and are easily distinguishable by the **orange colour which makes them stand out from the insulating body of the connector.**

The advantage of such an **exclusive solution** is that the **actuators disappear completely within the body of the connector**, making it easy to identify terminals not yet closed and eliminating possible obstacles to the movement of the conductors during installation and maintenance. In this manner during the cabling phase the **need for a tool to activate the terminal is completely eliminated and a simple operation is all you need to make the connection.**

### Shaped button for measuring instruments

The profile of the button used in the **SQUICH®** series inserts **allow a measuring probe to be inserted.**

This allows checks to be carried out to ensure that the wiring is correct.

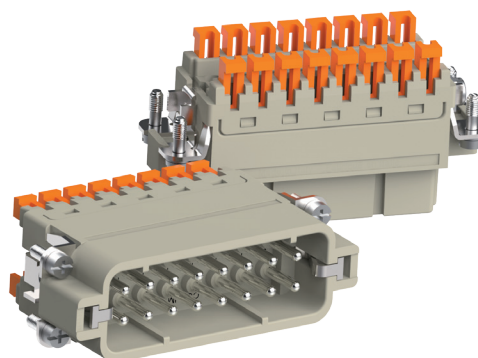

### CSAH-SQUICH® INSERTS SUM-UP

- ☑ **Reduced space**
- ☑ **Reduced wiring time**
- ☑ **No need for tools**
- ☑ **Quick identification of wired and non-wired terminals**
- ☑ **Terminals already open and ready for conductor clamping**
- ☑ **Built-in silver plated contacts**
- ☑ **Excellent fastening solution**
- ☑ **Great resistance to strong vibration**

### Simple terminal reopening

To reopen the terminals, simply introduce the tip of a common 0,5 x 3,5 mm flat blade screwdriver in the shaped pocket on the head of the actuator, and slightly rotate the screwdriver downwards: this will lift the actuator into its open terminal position.

### ☑ SQUICH® Connection technology

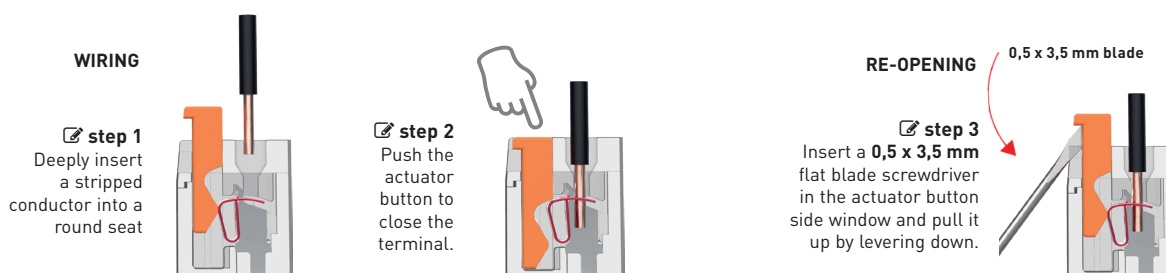

# CDA 10 poles + ⊕ 16A - 250V

enclosures: size "49.16"	page:
IL-BRID	374 - 377, 382
CZ7 IP67, single lever	384
W-TYPE for aggressive environments	519
E-Xtreme® corrosion proof	540
EMC	576

panel supports: COB + adaptor	page: 652 - 654
----------------------------------	--------------------

## inserts, screw terminal connection

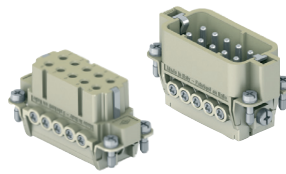

## inserts, screw terminal connection

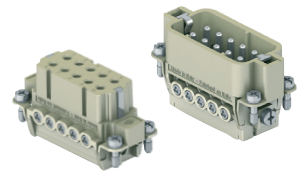

description

part No.

part No.

indirect, with pressure plate <sup>1)</sup>  
female inserts with female contacts  
male inserts with male contacts

**CDAF 10**  
**CDAM 10**

direct, without pressure plate <sup>2)</sup>  
female inserts with female contacts  
male inserts with male contacts

**CDAF 10 X**  
**CDAM 10 X**

- characteristics according to EN 61984:

**16A 250V 4kV 3**  
**16A 230/400V 4kV 2**

- cULus (UL for USA and Canada),

certified

- rated voltage according to UL/CSA: 600V
- insulation resistance:  $\geq 10 \text{ G}\Omega$
- ambient temperature limit:  $-40 \text{ }^\circ\text{C} \dots +125 \text{ }^\circ\text{C}$
- made of self-extinguishing thermoplastic resin UL 94V-0
- mechanical life:  $\geq 500$  cycles
- contact resistance:  $\leq 1 \text{ m}\Omega$
- according to recommendations EUROMAP N° 16
- for max. current load see the connector inserts derating diagram below; for more information see page 28

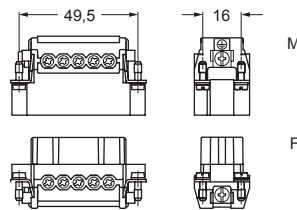

contacts side (front view)

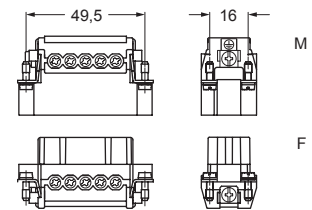
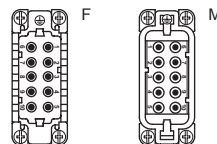

contacts side (front view)

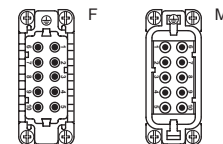

- inserts with pressure plate for conductors cross-sections: 0,5 - 4 mm<sup>2</sup> - AWG 20 - 12
- conductors stripping length: 7 mm
- terminal screw torque: 0,5 Nm (4.4 lb.in), for more information see page 20 and 21

- inserts without pressure plate for prepared conductors with cross-sections: 0,25 - 2,5 mm<sup>2</sup> - AWG 24 - 14
- terminal screw torque: 0,5 Nm (4.4 lb.in), for more information see page 20 and 21

**CDA 10 poles connector inserts**  
**Maximum current load derating diagram**

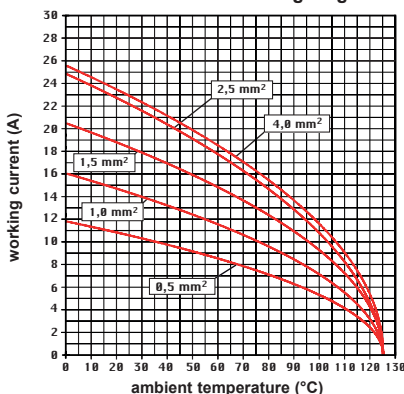

<sup>1)</sup> for unprepared conductors



<sup>2)</sup> for conductors with end sleeve ferrule





# CSAH-SQUICH® 10 poles + ⊕ 16A - 250V

enclosures: size "49.16"	page:
IL-BRID	374 - 377, 382
CZ7 IP67, single lever	384
W-TYPE for aggressive environments	519
E-Xtreme® corrosion proof	540
EMC	576
panel supports: COB + adaptor	page: 652 - 654

## inserts, spring terminal connections without tools

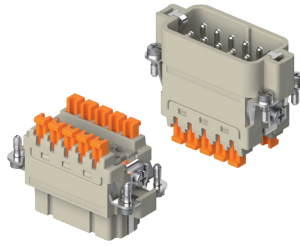

description	part No.
spring terminals with actuator button	<b>CSAHF 10</b>
female inserts with female contacts	<b>CSAHM 10</b>
male inserts with male contacts	

- characteristics according to EN 61984:  
**16A 250V 4kV 3**  
**16A 400V 4kV 2**
- cULus (UL for USA and Canada),
- EAC certified
- insulation resistance:  $\geq 10 \text{ G}\Omega$
- ambient temperature limit:  $-40 \text{ }^\circ\text{C} \dots +125 \text{ }^\circ\text{C}$
- made of self-extinguishing thermoplastic resin UL 94V-0
- mechanical life:  $\geq 500$  cycles
- contact resistance:  $\leq 3 \text{ m}\Omega$
- for max. current load see the connector inserts derating diagram below; for more information see page 28

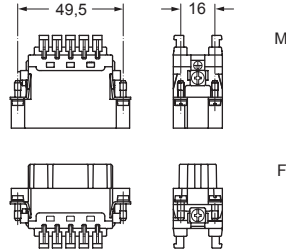

contacts side (front view)

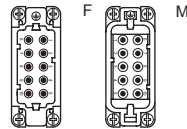

- inserts for connectors with the following sections:  
0,14 - 2,5 mm<sup>2</sup> - AWG 26 - 14
- for wires with crimped ferrule, usable section:  
up to 1,5 mm<sup>2</sup> (AWG 16)
- conductors stripping length: 9...11 mm

**CSAH 10 poles connector inserts**  
Maximum current load derating diagram

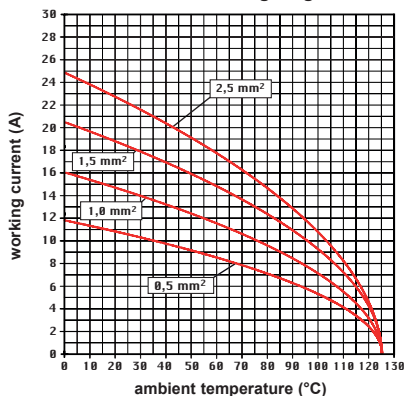

### SQUICH®-spring connection technology

#### WIRING

- Deeply insert a stripped conductor into a round terminal.
- Push the actuator button to close the terminal.

#### RE-OPENING

- Insert a **0,5 x 3,5 mm** flat blade screwdriver in the actuator button side window and pull it up by levering down.

# CDA 16 poles + ⊕ 16A - 250V

enclosures: size "66.16"	page:
IL-BRID	378 - 382
CZ7 IP67, single lever	385
W-TYPE for aggressive environments	520
E-Xtreme® corrosion proof	541
EMC	577
panel supports: COB + adaptor	page: 652 - 654

## inserts, screw terminal connection

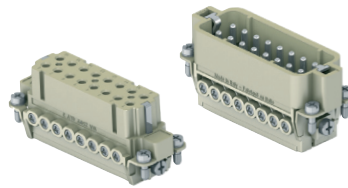

## inserts, screw terminal connection

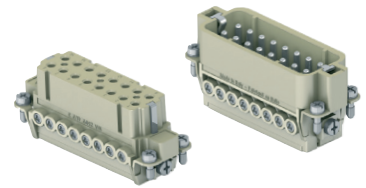

description	part No.	part No.
-------------	----------	----------

indirect, with pressure plate <sup>1)</sup>  
female inserts with female contacts  
male inserts with male contacts

**CDAF 16**  
**CDAM 16**

direct, without pressure plate <sup>2)</sup>  
female inserts with female contacts  
male inserts with male contacts

**CDAF 16 X**  
**CDAM 16 X**

- characteristics according to EN 61984:

**16A 250V 4kV 3**  
**16A 230/400V 4kV 2**

- cULus (UL for USA and Canada),

certified

- rated voltage according to UL/CSA: 600V
- insulation resistance: ≥ 10 GΩ
- ambient temperature limit: -40 °C ... +125 °C
- made of self-extinguishing thermoplastic resin UL 94V-0
- mechanical life: ≥ 500 cycles
- contact resistance: ≤ 1 mΩ
- according to recommendations EUROMAP N° 13 / N° 14.1
- for max. current load see the connector inserts derating diagram below; for more information see page 28

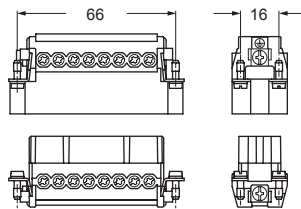

contacts side (front view)

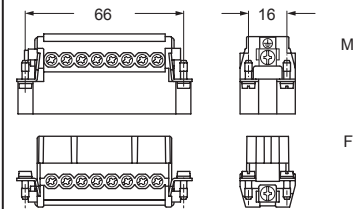
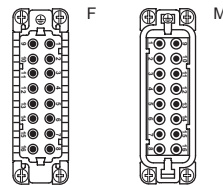

contacts side (front view)

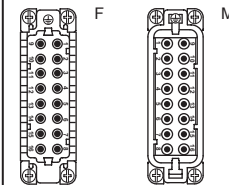

- inserts with pressure plate for conductors cross-sections:  
0,5 - 4 mm<sup>2</sup> - AWG 20 - 12
- conductors stripping length: 7 mm
- terminal screw torque: 0,5 Nm (4.4 lb.in), for more information see page 20 and 21

- inserts without pressure plate for prepared conductors with cross-sections:  
0,25 - 2,5 mm<sup>2</sup> - AWG 24 - 14
- terminal screw torque: 0,5 Nm (4.4 lb.in), for more information see page 20 and 21

**CDA 16 poles connector inserts**  
**Maximum current load derating diagram**

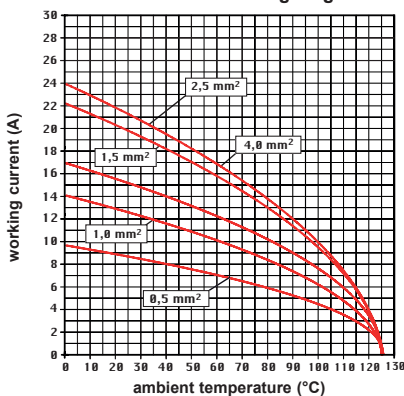

<sup>1)</sup> for unprepared conductors



<sup>2)</sup> for conductors with end sleeve ferrule



# CSAH-SQUICH® 16 poles + ⊕ 16A - 250V

enclosures: size "66.16"	page:
IL-BRID	378 - 382
CZ7 IP67, single lever	385
W-TYPE for aggressive environments	520
E-Xtreme® corrosion proof	541
EMC	577
panel supports: COB + adaptor	page: 652 - 654

## inserts, spring terminal connections without tools

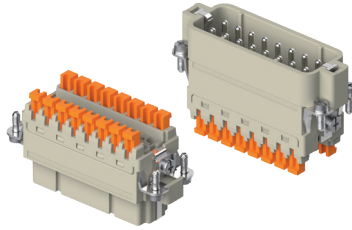

description	part No.
-------------	----------

spring terminals with actuator button  
female inserts with female contacts  
male inserts with male contacts

**CSAHF 16**  
**CSAHM 16**

- characteristics according to EN 61984:

**16A 250V 4kV 3**  
**16A 400V 4kV 2**

- cULus (UL for USA and Canada),

**ERC** certified

- insulation resistance:  $\geq 10 \text{ G}\Omega$
- ambient temperature limit:  $-40 \text{ }^\circ\text{C} \dots +125 \text{ }^\circ\text{C}$
- made of self-extinguishing thermoplastic resin UL 94V-0
- mechanical life:  $\geq 500$  cycles
- contact resistance:  $\leq 3 \text{ m}\Omega$
- for max. current load see the connector inserts derating diagram below; for more information see page 28

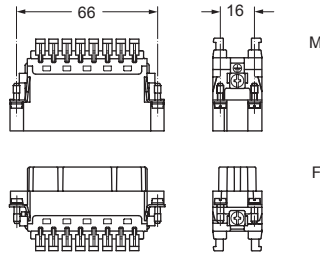

contacts side (front view)

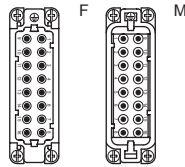

- inserts for connectors with the following sections: 0,14 - 2,5 mm<sup>2</sup> - AWG 26 - 14
- for wires with crimped ferrule, usable section: up to 1,5 mm<sup>2</sup> (AWG 16)
- conductors stripping length: 9...11 mm

**CSAH 16 poles connector inserts**  
**Maximum current load derating diagram**

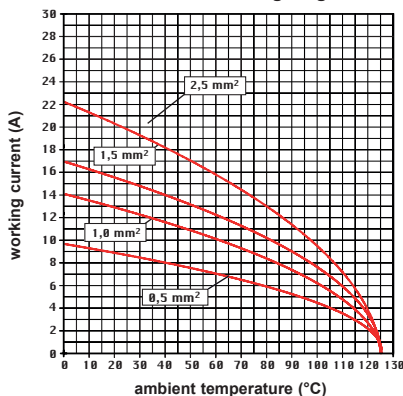

### SQUICH®-spring connection technology

#### WIRING

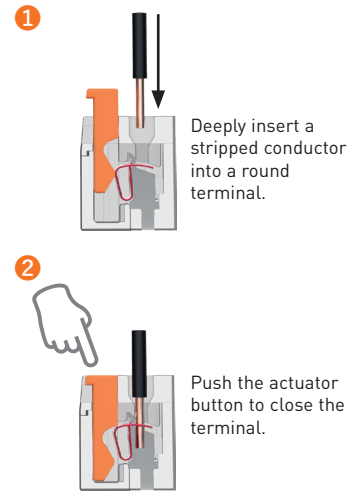

#### RE-OPENING

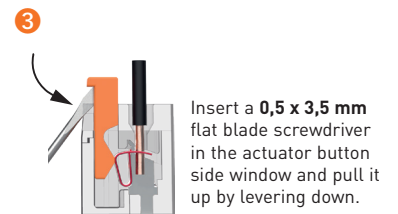

# CDA 32 poles + ⊕ 16A - 250V

enclosures:  
size "66.40"

page:

C-TYPE IP65/IP66  
W-TYPE for aggressive environments  
E-Xtreme® corrosion proof

431 - 434  
527  
548

inserts,  
screw terminal connection

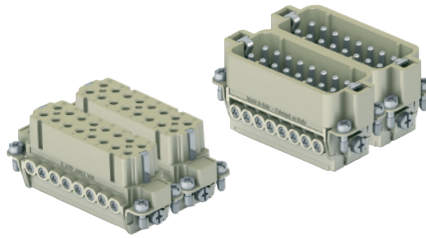

inserts,  
screw terminal connection

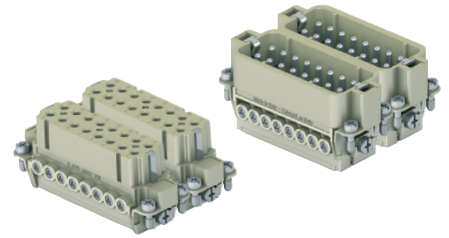

description

part No.

part No.

part No.

part No.

indirect, with pressure plate <sup>1)</sup>  
female inserts, No. (1-16) and (17-32)  
male inserts, No. (1-16) and (17-32)

**CDAF 16**  
**CDAM 16**

**CDAF 16 N**  
**CDAM 16 N**

direct, without pressure plate <sup>2)</sup>  
female inserts, No. (1-16) and (17-32)  
male inserts, No. (1-16) and (17-32)

**CDAF 16 X**  
**CDAM 16 X**

**CDAF 16 XN**  
**CDAM 16 XN**

- characteristics according to EN 61984:

**16A 250V 4kV 3**  
**16A 230/400V 4kV 2**

- cULus (UL for USA and Canada),

certified

- rated voltage according to UL/CSA: 600V
- insulation resistance:  $\geq 10 \text{ G}\Omega$
- ambient temperature limit:  $-40 \text{ }^\circ\text{C} \dots +125 \text{ }^\circ\text{C}$
- made of self-extinguishing thermoplastic resin UL 94V-0
- mechanical life:  $\geq 500$  cycles
- contact resistance:  $\leq 1 \text{ m}\Omega$
- according to recommendations EUROMAP N° 12 / N° 62
- for max. current load see the connector inserts derating diagram below; for more information see page 28

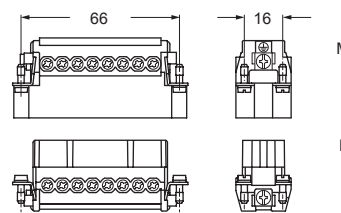

contacts side (front view)

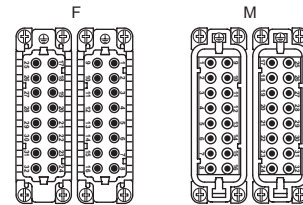

- inserts with pressure plate for conductors cross-sections:  $0,5 - 4 \text{ mm}^2$  - AWG 20 - 12
- conductors stripping length: 7 mm
- terminal screw torque:  $0,5 \text{ Nm}$  (4.4 lb.in), for more information see page 20 and 21

<sup>1)</sup> for unprepared conductors

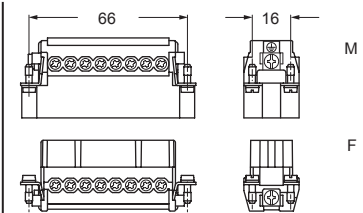

contacts side (front view)

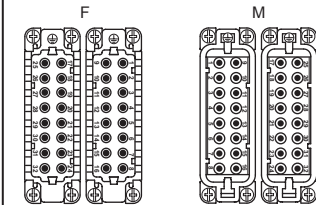

- inserts without pressure plate for prepared conductors with cross-sections:  $0,25 - 2,5 \text{ mm}^2$  - AWG 24 - 14
- terminal screw torque:  $0,5 \text{ Nm}$  (4.4 lb.in), for more information see page 20 and 21

<sup>2)</sup> for conductors with end sleeve ferrule



**CDA 3 poles connector inserts**  
**Maximum current load derating diagram**

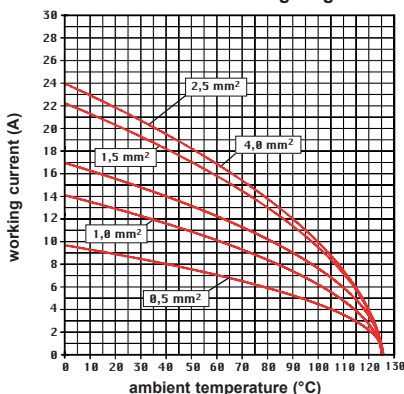

# CSAH-SQUICH® 32 poles + ⊕ 16A - 250V

enclosures:  
size "66.40"

page:

C-TYPE IP65/IP66  
W-TYPE for aggressive environments  
E-Xtreme® corrosion proof

431 - 434  
527  
548

inserts,  
spring terminal connections without tools

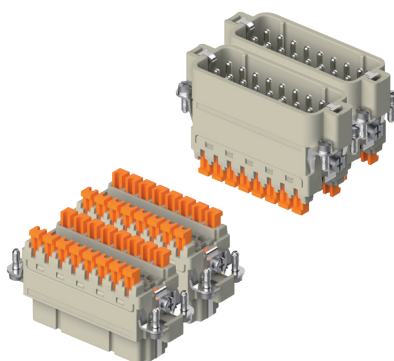

description	part No.	part No.
spring terminals with actuator button female inserts, No. (1-16) and (17-32) male inserts, No. (1-16) and (17-32)	<b>CSAHF 16</b> <b>CSAHM 16</b>	<b>CSAHF 16 N</b> <b>CSAHM 16 N</b>

- characteristics according to EN 61984:

**16A 250V 4kV 3**  
**16A 400V 4kV 2**

- cULus (UL for USA and Canada),



ERC certified

- insulation resistance:  $\geq 10 \text{ G}\Omega$

- ambient temperature limit:  $-40 \text{ }^\circ\text{C} \dots +125 \text{ }^\circ\text{C}$

- made of self-extinguishing thermoplastic resin  
UL 94V-0

- mechanical life:  $\geq 500$  cycles

- contact resistance:  $\leq 3 \text{ m}\Omega$

- for max. current load see the connector inserts derating diagram below; for more information see page 28

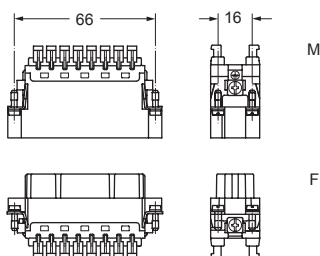

contacts side (front view)

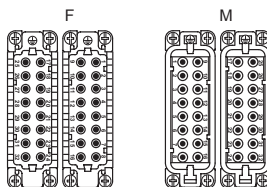

- inserts for connectors with the following sections:  
0,14 - 2,5 mm<sup>2</sup> - AWG 26 - 14
- for wires with crimped ferrule, usable section:  
up to 1,5 mm<sup>2</sup> (AWG 16)
- conductors stripping length: 9...11 mm

CSAH 32 poles connector inserts  
Maximum current load derating diagram

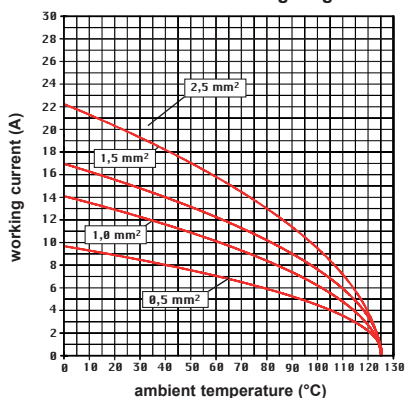

### SQUICH®-spring connection technology

#### WIRING

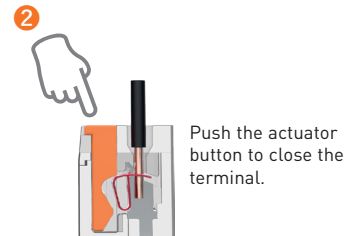
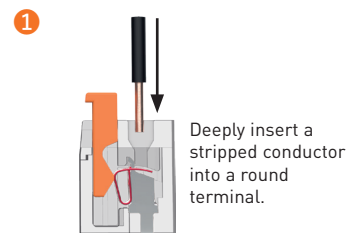

#### RE-OPENING

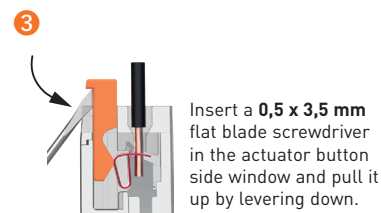

# CDC 10 poles + ⊕ 16A - 250V

enclosures: size "49.16"	page:
IL-BRID	374 - 377, 382
CZ7 IP67, single lever	384
W-TYPE for aggressive environments	519
E-Xtreme® corrosion proof	540
EMC	576

panel supports: COB + adaptor	page: 652 - 654
----------------------------------	--------------------

## inserts, crimp connections

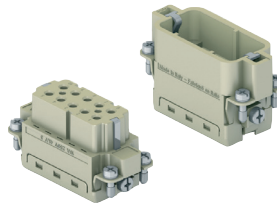

## 16A crimp contacts standard or for advanced opening silver and gold plated

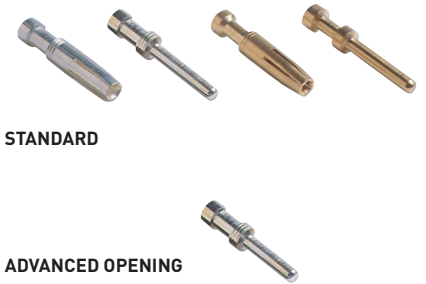

description	part No.	part No.
without contacts (to be ordered separately)		
female inserts for female contacts	<b>CDCF 10</b>	
male inserts for male contacts	<b>CDCM 10</b>	
16A female contacts		
0,14-0,37 mm <sup>2</sup> AWG 26-22 one groove		<b>CCFA 0.3</b>
0,5 mm <sup>2</sup> AWG 20 with no grooves		<b>CCFA 0.5</b>
0,75 mm <sup>2</sup> AWG 18 one groove (back side)		<b>CCFA 0.7</b>
1 mm <sup>2</sup> AWG 18 one groove		<b>CCFA 1.0</b>
1,5 mm <sup>2</sup> AWG 16 two grooves		<b>CCFA 1.5</b>
2,5 mm <sup>2</sup> AWG 14 three grooves		<b>CCFA 2.5</b>
3 mm <sup>2</sup> AWG 12 one wide groove		<b>CCFA 3.0</b>
4 mm <sup>2</sup> AWG 12 with no grooves		<b>CCFA 4.0</b>
16A male contacts		
0,14-0,37 mm <sup>2</sup> AWG 26-22 one groove		<b>CCMA 0.3</b>
0,5 mm <sup>2</sup> AWG 20 with no grooves		<b>CCMA 0.5</b>
0,75 mm <sup>2</sup> AWG 18 one groove (back side)		<b>CCMA 0.7</b>
1 mm <sup>2</sup> AWG 18 one groove		<b>CCMA 1.0</b>
1,5 mm <sup>2</sup> AWG 16t wo grooves		<b>CCMA 1.5</b>
2,5 mm <sup>2</sup> AWG 14 three grooves		<b>CCMA 2.5</b>
3 mm <sup>2</sup> AWG 12 one wide groove		<b>CCMA 3.0</b>
4 mm <sup>2</sup> AWG 12 with no grooves		<b>CCMA 4.0</b>
16A male crimp contacts for advanced opening		
0,5 mm <sup>2</sup> AWG 20 with no grooves		<b>CC 0.5 AN</b>
0,75 mm <sup>2</sup> AWG 18 one groove (back side)		<b>CC 0.7 AN</b>
1 mm <sup>2</sup> AWG 18 one groove		<b>CC 1.0 AN</b>
1,5 mm <sup>2</sup> AWG 16 two grooves		<b>CC 1.5 AN</b>
2,5 mm <sup>2</sup> AWG 14 three grooves		<b>CC 2.5 AN</b>

silver plated	gold plated+
---------------	--------------

\* for basic or high thickness gold plating, please refer to page 675

- characteristics according to EN 61984:  
**16A 250V 4kV 3**  
**16A 230/400V 4kV 2**
- cULus (UL for USA and Canada),
- BUREAU VERITAS ERI certified
- rated voltage according to UL/CSA: 600V
- insulation resistance: ≥ 10 GΩ
- ambient temperature limit: -40 °C ... +125 °C
- made of self-extinguishing thermoplastic resin UL 94V-0
- mechanical life: ≥ 500 cycles
- contact resistance: ≤ 1 mΩ
- according to recommendations EUROMAP N° 16
- for max. current load see the connector inserts derating diagram below; for more information see page 28

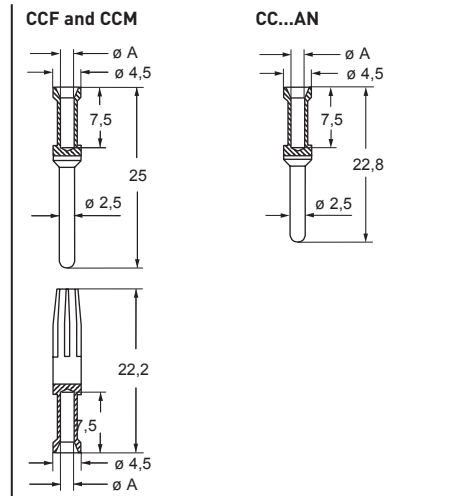
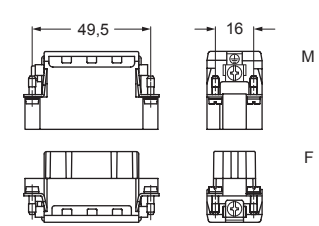

CCF, CCM and CC...AN contacts		
conductor section mm <sup>2</sup>	conductor slot ø A (mm)	conductors stripping length (mm)
0,14-0,37	0,9	7,5
0,5	1,1	7,5
0,75	1,3	7,5
1,0	1,45	7,5
1,5	1,8	7,5
2,5	2,2	7,5
3	2,55	7,5
4	2,85	7,5

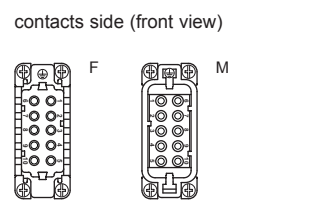
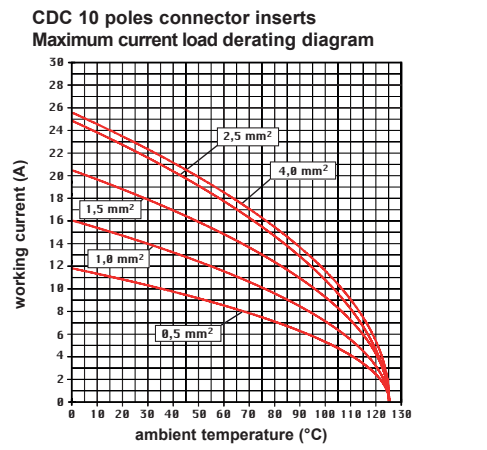

- it is recommended to crimp the contacts with crimping tools homologated by ILME (please see the crimping tool section 16A contacts, CCF, CCM and CC...AN series on pages 705 - 741)



# CDC 16 poles + ⊕ 16A - 250V

enclosures: size "66.16"	page:
IL-BRID	378 - 382
CZ7 IP67, single lever	385
W-TYPE for aggressive environments	520
E-Xtreme® corrosion proof	541
EMC	577
panel supports: COB + adaptor	page: 652 - 654

## inserts, crimp connections

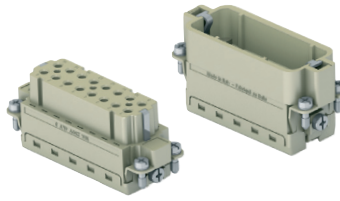

## 16A crimp contacts standard or for advanced opening silver and gold plated

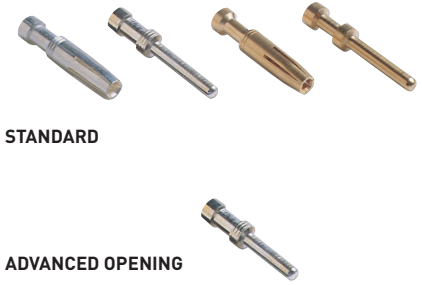

STANDARD

ADVANCED OPENING

description	part No.	part No.
without contacts (to be ordered separately)		
female inserts for female contacts	<b>CDCF 16</b>	
male inserts for male contacts	<b>CDCM 16</b>	
16A female contacts		
0,14-0,37 mm <sup>2</sup> AWG 26-22 one groove		<b>CCFA 0.3</b>
0,5 mm <sup>2</sup> AWG 20 with no grooves		<b>CCFA 0.5</b>
0,75 mm <sup>2</sup> AWG 18 one groove (back side)		<b>CCFA 0.7</b>
1 mm <sup>2</sup> AWG 18 one groove		<b>CCFA 1.0</b>
1,5 mm <sup>2</sup> AWG 16 two grooves		<b>CCFA 1.5</b>
2,5 mm <sup>2</sup> AWG 14 three grooves		<b>CCFA 2.5</b>
3 mm <sup>2</sup> AWG 12 one wide groove		<b>CCFA 3.0</b>
4 mm <sup>2</sup> AWG 12 with no grooves		<b>CCFA 4.0</b>
		<b>CCFD 0.3</b>
		<b>CCFD 0.5</b>
		<b>CCFD 0.7</b>
		<b>CCFD 1.0</b>
		<b>CCFD 1.5</b>
		<b>CCFD 2.5</b>
		<b>CCFD 3.0</b>
		<b>CCFD 4.0</b>
16A male contacts		
0,14-0,37 mm <sup>2</sup> AWG 26-22 one groove		<b>CCMA 0.3</b>
0,5 mm <sup>2</sup> AWG 20 with no grooves		<b>CCMA 0.5</b>
0,75 mm <sup>2</sup> AWG 18 one groove (back side)		<b>CCMA 0.7</b>
1 mm <sup>2</sup> AWG 18 one groove		<b>CCMA 1.0</b>
1,5 mm <sup>2</sup> AWG 16t wo grooves		<b>CCMA 1.5</b>
2,5 mm <sup>2</sup> AWG 14 three grooves		<b>CCMA 2.5</b>
3 mm <sup>2</sup> AWG 12 one wide groove		<b>CCMA 3.0</b>
4 mm <sup>2</sup> AWG 12 with no grooves		<b>CCMA 4.0</b>
		<b>CCMD 0.3</b>
		<b>CCMD 0.5</b>
		<b>CCMD 0.7</b>
		<b>CCMD 1.0</b>
		<b>CCMD 1.5</b>
		<b>CCMD 2.5</b>
		<b>CCMD 3.0</b>
		<b>CCMD 4.0</b>
16A male crimp contacts for advanced opening		
0,5 mm <sup>2</sup> AWG 20 with no grooves		<b>CC 0.5 AN</b>
0,75 mm <sup>2</sup> AWG 18 one groove (back side)		<b>CC 0.7 AN</b>
1 mm <sup>2</sup> AWG 18 one groove		<b>CC 1.0 AN</b>
1,5 mm <sup>2</sup> AWG 16 two grooves		<b>CC 1.5 AN</b>
2,5 mm <sup>2</sup> AWG 14 three grooves		<b>CC 2.5 AN</b>

silver plated

gold plated+

\* for basic or high thickness gold plating, please refer to page 675

- characteristics according to EN 61984:  
**16A 250V 4kV 3**  
**16A 230/400V 4kV 2**
- cULus (UL for USA and Canada),
- certified
- rated voltage according to UL/CSA: 600V
- insulation resistance: ≥ 10 GΩ
- ambient temperature limit: -40 °C ... +125 °C
- made of self-extinguishing thermoplastic resin UL 94V-0
- mechanical life: ≥ 500 cycles
- contact resistance: ≤ 1 mΩ
- according to recommendations EUROMAP N° 13 / N° 14.1
- for max. current load see the connector inserts derating diagram below; for more information see page 28

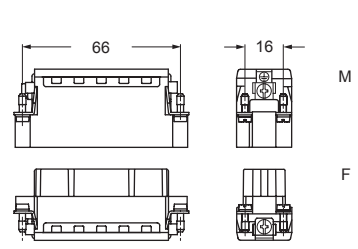

contacts side (front view)

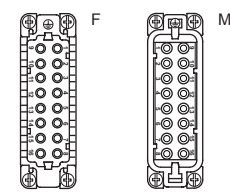

- it is recommended to crimp the contacts with crimping tools homologated by ILME (please see the crimping tool section 16A contacts, CCF, CCM and CC...AN series on pages 705 - 741)

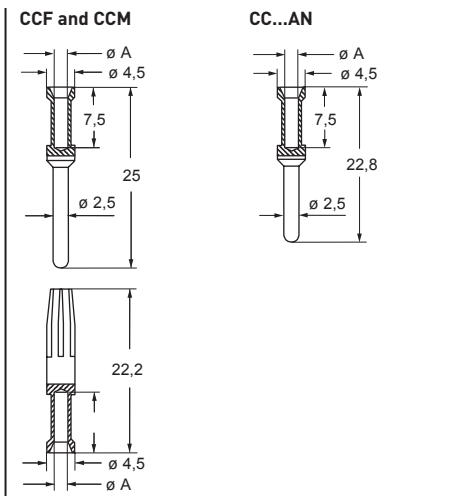

CCF, CCM and CC...AN contacts		
conductor section mm <sup>2</sup>	conductor slot ø A (mm)	conductors stripping length (mm)
0,14-0,37	0,9	7,5
0,5	1,1	7,5
0,75	1,3	7,5
1,0	1,45	7,5
1,5	1,8	7,5
2,5	2,2	7,5
3	2,55	7,5
4	2,85	7,5

**CDC 16 poles connector inserts**  
**Maximum current load derating diagram**

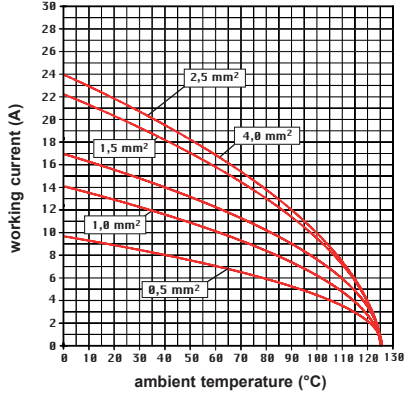

# CDC 32 poles + ⊕ 16A - 250V

enclosures:  
size "66.40"

page:

C-TYPE IP65/IP66  
W-TYPE for aggressive environments  
E-Xtreme® corrosion proof

431 - 434  
527  
548

## inserts, crimp connections

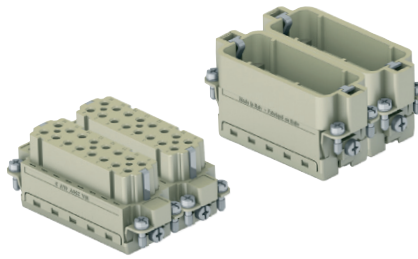

## 16A crimp contacts standard or for advanced opening silver and gold plated



STANDARD

ADVANCED OPENING

description	part No.	part No.	part No.
without contacts (to be ordered separately)			
female inserts, No. (1-16) and (17-32)	<b>CDCF 16</b>	<b>CDCF 16 N</b>	
male inserts, No. (1-16) and (17-32)	<b>CDCM 16</b>	<b>CDCM 16 N</b>	
16A female contacts			
0,14-0,37 mm <sup>2</sup> AWG 26-22 one groove			<b>CCFA 0.3</b>
0,5 mm <sup>2</sup> AWG 20 with no grooves			<b>CCFA 0.5</b>
0,75 mm <sup>2</sup> AWG 18 one groove (back side)			<b>CCFA 0.7</b>
1 mm <sup>2</sup> AWG 18 one groove			<b>CCFA 1.0</b>
1,5 mm <sup>2</sup> AWG 16 two grooves			<b>CCFA 1.5</b>
2,5 mm <sup>2</sup> AWG 14 three grooves			<b>CCFA 2.5</b>
3 mm <sup>2</sup> AWG 12 one wide groove			<b>CCFA 3.0</b>
4 mm <sup>2</sup> AWG 12 with no grooves			<b>CCFA 4.0</b>
16A male contacts			
0,14-0,37 mm <sup>2</sup> AWG 26-22 one groove			<b>CCMA 0.3</b>
0,5 mm <sup>2</sup> AWG 20 with no grooves			<b>CCMA 0.5</b>
0,75 mm <sup>2</sup> AWG 18 one groove (back side)			<b>CCMA 0.7</b>
1 mm <sup>2</sup> AWG 18 one groove			<b>CCMA 1.0</b>
1,5 mm <sup>2</sup> AWG 16t wo grooves			<b>CCMA 1.5</b>
2,5 mm <sup>2</sup> AWG 14 three grooves			<b>CCMA 2.5</b>
3 mm <sup>2</sup> AWG 12 one wide groove			<b>CCMA 3.0</b>
4 mm <sup>2</sup> AWG 12 with no grooves			<b>CCMA 4.0</b>
16A male crimp contacts for advanced opening			
0,5 mm <sup>2</sup> AWG 20 with no grooves			<b>CC 0.5 AN</b>
0,75 mm <sup>2</sup> AWG 18 one groove (back side)			<b>CC 0.7 AN</b>
1 mm <sup>2</sup> AWG 18 one groove			<b>CC 1.0 AN</b>
1,5 mm <sup>2</sup> AWG 16 two grooves			<b>CC 1.5 AN</b>
2,5 mm <sup>2</sup> AWG 14 three grooves			<b>CC 2.5 AN</b>

silver plated

gold plated+

† for basic or high thickness gold plating, please refer to page 675

- characteristics according to EN 61984:

**16A 250V 4kV 3**  
**16A 230/400V 4kV 2**

- cULus (UL for USA and Canada),

certified

- rated voltage according to UL/CSA: 600V
- insulation resistance: ≥ 10 GΩ
- ambient temperature limit: -40 °C ... +125 °C
- made of self-extinguishing thermoplastic resin UL 94V-0
- mechanical life: ≥ 500 cycles
- contact resistance: ≤ 1 mΩ
- according to recommendations EUROMAP N° 12 / N° 62
- for max. current load see the connector inserts derating diagram below; for more information see page 28

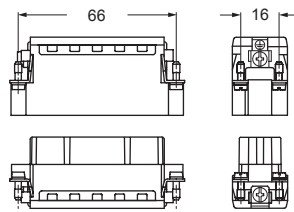

contacts side (front view)

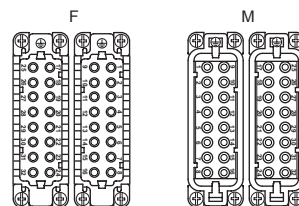

- it is recommended to crimp the contacts with crimping tools homologated by ILME (please see the crimping tool section 16A contacts, CCF, CCM and CC...AN series on pages 705 - 741)

### CCF and CCM

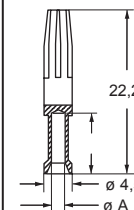
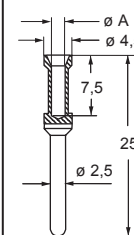

### CC...AN

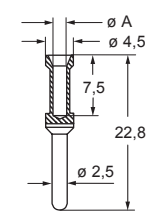

### CCF, CCM and CC...AN contacts

conductor section mm <sup>2</sup>	conductor slot ø A (mm)	conductors stripping length (mm)
0,14-0,37	0,9	7,5
0,5	1,1	7,5
0,75	1,3	7,5
1,0	1,45	7,5
1,5	1,8	7,5
2,5	2,2	7,5
3	2,55	7,5
4	2,85	7,5

CDC 32 poles connector inserts  
Maximum current load derating diagram

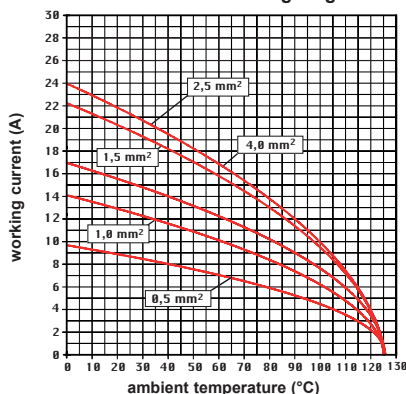

## CNE - CNE...RY series

### CNE series

**CNE Series are the evolution of former series CN**, one of the oldest and most successful heavy-duty multipole connection products of ILME. The evolution consisted in the complete overhauling of the connector bodies, the introduction of a **captive stainless steel protection plate for unprepared conductor strands** in the screw terminals, the adoption of galvanized steel terminal screws and the **increase of the rated voltage from former 400V to 500V**.

The ancestor series CN was intermateable with the German industry standard design with screw-type terminals, for **16A** rated current per pole and solid pins  $\varnothing$  2,5 mm. The two larger sizes of this series – ILME designation “77.27” for **16 P + PE** and “104.27” for **24 P + PE** – share the dimensions of a similarly old and very popular series (series **CD** in this catalogue) dimensionally standardized by the historic standards of series **DIN 43652**, later replaced by **EN 175 301-801**. The lower sizes “44.27” for **6 P + PE** and “57.27” for **10 P + PE** were proportionally scaled down from the above mentioned larger sizes.

CNE connectors series come in two main variants:

- with pressure (protection) plate, **for unprepared conductors**, to preserve conductor strands from being cut from the screw head, or
- without pressure (protection) plate **[suffix X]**, for **prepared conductors** (crimped with insulated or non-insulated wire ferrule of suitable size).

**Q NOTE** – Prepared conductors in principle do not need any pressure (protection) plate. Use of prepared conductors is possible – although with no added value – also for CNE with pressure plate, but the highest conductor cross-sectional area  $4 \text{ mm}^2 / 12 \text{ AWG}$  can be used only unprepared.

CNE series connection technology is **screw-type**, requiring very simple and popular tools, like a 0,8x4 mm flat blade screwdriver or a Ph0 cross-headed screwdriver (torque to apply 0,5 Nm). All connectors series CNE have their contact holder (wiring side) duly cone shaped around each terminal cavity to securely guide all stranded wires inside the terminal seat. Terminal screw are unlosably retained in their seats.

**All terminals are presented completely open** (unscrewed), ready to be wired, to allow spare of assembly time. The PE terminal is also screw-type (M4 screw with pressure plate, torque to apply 1,2 Nm) and is located on the mounting bracket on the pole #1 side. It covers the same conductor cross-sectional area range of the line terminals. Due to its design, the PE terminal allows two conductors per terminal (one on each side of the M4 screw); in such case it is recommended that these conductors are of the same size. Series CNE connectors are **polarized against 180° incorrect mating** by a system of keys and keyways along the contour of their mating faces.

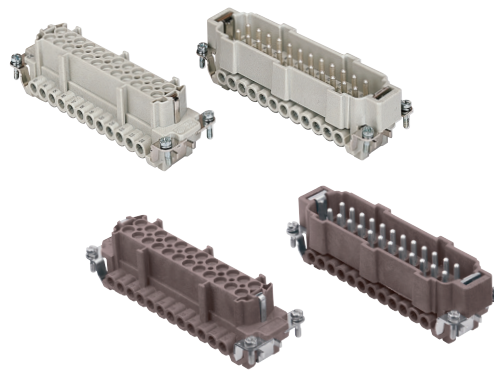

CNE...RY variant

By partial or total replacement of the four M3 fixing screws, CNE connectors series may also use three different series of **coding and guide pins** to implement, e.g. in case of multiple identical connectors installed side by side, an “idiot-proof” system to avoid mating mismatches with counterpart.

**Q NOTE** – Coding may be obtained respectively by using: **CR 20 or CR 20 D single coding pins**, for up to 6 different codings, **CRF / CRM or CRF D / CRM D double coding and guide pins**, for up to 16 different codings, and the previous **double coding and guide pins plus a third element CR 72 or CR 72 D**, to allow up to 72 different coding combinations.

**Connectors series CNE come in four sizes:**

- size “44.27”      6 P + ⊕
- size “57.27”      10 P + ⊕
- size “77.27”      16 P + ⊕
- size “104.27”     24 P + ⊕

Two inserts – one with suffix **N** to denote special numbering, respectively CNEF/M 16 TN (or TXN) with pole numbering 17 to 32, CNEF/M 24 TN (or TXN) with numbering 25 to 48 – can be used with connector enclosures sized “77.62” or “104.62” to provide:

- size “77.62”      32 P + ⊕
- size “104.62”    48 P + ⊕

### CNE...RY series for high temperatures

CNE series are available also in the **CNE...RY variant for use at high ambient temperatures up to 180 °C**.

Thanks to a specific thermoplastic insulating material (whose natural colour is brown) and in combination with the dedicated connector enclosures “R-Type” for 180 °C temperature withstand, these multipole connectors are particularly suitable for installation in places in proximity of heat sources such as near ovens, moulds for thermoplastic or rubber moulding, moulds in foundries, paint booths, etc.

## CSH-SQUICH® series

### CSH-SQUICH® series

#### Spring connection with actuator button

In this view the wires are connected to the insert contacts by means of a spring terminal with actuator button.

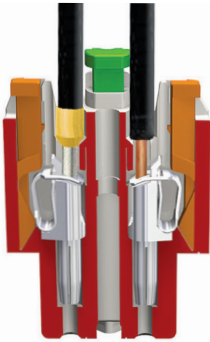
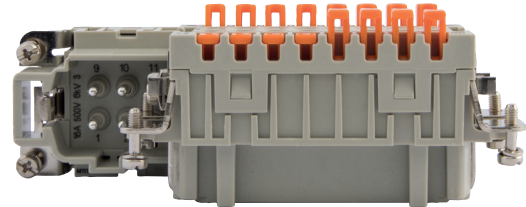

### CSH-SQUICH® INSERTS SUM-UP

- ☑ No special wire preparation (other than stripping)
- ☑ No wiring tool is necessary
- ☑ It offers an excellent fastening solution and a great resistance to strong vibrations;
- ☑ It allows solid and flexible wires with sections between 0,14 and 2,5 mm<sup>2</sup> (26-14 AWG) to be used (both with non-prepared conductors and those prepared with ferrule)
- ☑ It greatly reduces insert preparation and cabling times
- ☑ Built-in silver plated contacts



#### Shaped button for measuring instruments

The profile of the button used in the **SQUICH®** series inserts **allow a measuring probe to be inserted.**

This allows checks to be carried out to ensure that the wiring is correct.

#### Simple terminal reopening

To reopen the terminals, simply introduce the tip of a common 0,5 x 3,5 mm flat blade screwdriver in the shaped pocket on the head of the actuator, and slightly rotate the screwdriver downwards: this will lift the actuator into its open terminal position.

# CNE and CSH-SQUICH® series

## TECHNICAL FEATURES

Insert series		CNE (with pressure plate) CNE...X (w/o pressure plate) CNE...RY (for high temperature)	CSH-SQUICH®
No. of poles <sup>1)</sup>	Main contacts + ⊕	<b>6, 10, 16, 24, (32 = 2x16) (48 = 2x24)</b>	
	auxiliary contacts	—	
Rated current <sup>2)</sup>		16A	
EN IEC 61984 Pollution degree 3	rated voltage	500V	
	rated impulse voltage	6kV	
	<b>pollution degree</b>	<b>3</b>	
EN IEC 61984 Pollution degree 2	rated voltage	400/690V	
	rated impulse voltage	6kV	
	<b>pollution degree</b>	<b>2</b>	
UL / CSA certification	rated voltage (a.c./d.c.)	600V	
Contact resistance		≤ 1 mΩ	≤ 3 mΩ
Insulation resistance		≥ 10 GΩ	
Ambient temperature limit (°C)	min	-40 °C	-40 °C
	max	+125 °C / <b>+180 °C (CNE...RY)</b>	+125 °C
Degree of protection	with enclosures (according to type)	<b>IP65, IP66/IP69, IP66/IP67/IP69, IP66/IP68/IP69</b>	<b>IP65, IP66, IP67, IP68, IP69</b>
	without enclosures - termination side on male and female inserts - mating side on female inserts	<b>IP20 (IPXXB)</b>	<b>IP20</b>
Conductor connections		screw type	spring and clamp with actuator button
Conductor cross-sectional area	mm <sup>2</sup>	0,5 - 4 <b>(CNE)</b>	0,14 - 2,5
		0,25 - 2,5 <b>(CNE...X)</b>	
	AWG	20 - 12 <b>(CNE)</b>	26 - 14
		24 - 14 <b>(CNE...X)</b>	
Mechanical endurance (mating cycles)		≥ 500	

1) Polarities shown in brackets may be obtained by using two inserts in their own double-sized housings

2) Please check the inserts derating diagrams to establish the actual maximum operating current according to the ambient temperature, the conductor cross-sectional area, the polarity of the connector, and any external constraint may derive e.g. by the continuous operating temperature sustained by the chosen conductor sheathing or by end-product safety standards fixing max allowed temperature rise on terminals (e.g. 30 K, 45 K or 50 K)



# CNE CSH-SQUICH® 6 poles + ⊕ 16A - 500V

enclosures: size "44.27"	page:
C-TYPE IP65/IP66	387 - 392
C7 IP67, single lever	436 - 437
V-TYPE IP65/IP66, single lever	444 - 447
BIG hoods	466 - 467
T-TYPE IP65 insulating	480 - 481
T-TYPE / W IP66 insulating	489
HYGIENIC T-TYPE / H IP66/IP69	501
HYGIENIC T-TYPE / C IP66/IP69, -50 °C	506
W-TYPE for aggressive environments	521
E-Xtreme® corrosion proof	530 - 531, 542, 550 - 551
EMC	578
Central lever	603 - 605
LS-TYPE	618 - 619
IP68	632 - 635

panel supports: COB	page: 652 - 653
------------------------	--------------------

## inserts, screw terminal connections

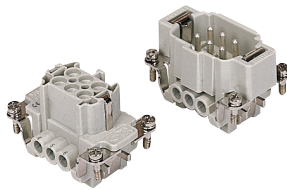

## inserts, spring terminal connections without tools

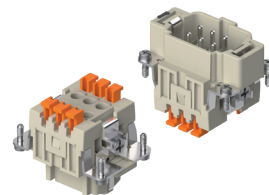

description	part No.	part No.
indirect, with plate <sup>1)</sup> female inserts with female contacts male inserts with male contacts	<b>CNEF 06 T</b> <b>CNEM 06 T</b>	
direct, without plate <sup>2)</sup> female inserts with female contacts male inserts with male contacts	<b>CNEF 06 TX</b> <b>CNEM 06 TX</b>	
spring terminals with actuator button female inserts with female contacts male inserts with male contacts		<b>CSHF 06</b> <b>CSHM 06</b>

- characteristics according to EN 61984:  
**16A 500V 6kV 3**  
**16A 400/690V 6kV 2**
- **UL** (UL for USA and Canada), **CEC**, **DNV-GL**
- **BUREAU VERITAS** **EAC** certified
- rated voltage according to UL/CSA: 600V
- insulation resistance: ≥ 10 GΩ
- ambient temperature limit: -40 °C ... +125 °C
- made of self-extinguishing thermoplastic resin UL 94V-0
- mechanical life: ≥ 500 cycles
- contact resistance: ≤ 1 mΩ (CNE) - ≤ 3 mΩ (CSH)
- for max. current load see the connector inserts derating diagrams below; for more information see page 28

**CNE 06 poles connector inserts**  
Maximum current load derating diagram

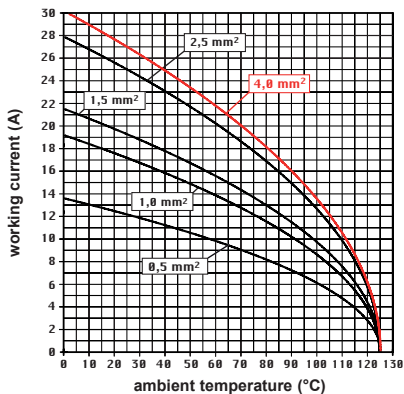

**CSH 06 poles connector inserts**  
Maximum current load derating diagram

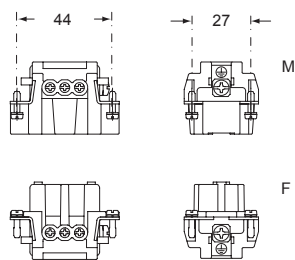
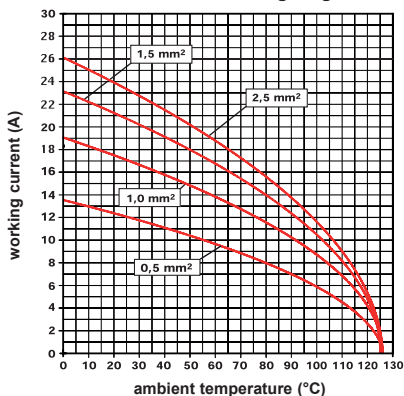

contacts side (front view)

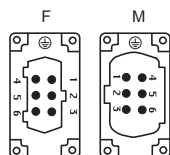

- inserts with plate for section conductors:  
0,5 - 4 mm<sup>2</sup> - AWG 20 - 12
- inserts without plate for section conductors:  
0,25 - 2,5 mm<sup>2</sup> - AWG 24 - 14
- conductors stripping length: 7 mm
- terminal screw torque: 0,5 Nm (4,4 lb.in), for more information see page 20 and 21

<sup>1)</sup> for unprepared conductors



<sup>2)</sup> for conductors with end sleeve ferrule

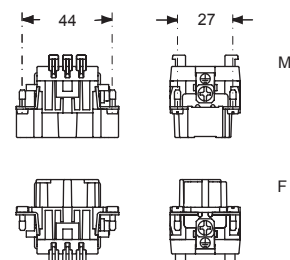

contacts side (front view)

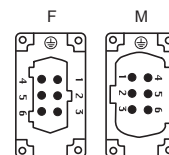

- inserts for connectors with the following sections:  
0,14 - 2,5 mm<sup>2</sup> - AWG 26 - 14
- conductors stripping length: 9...11 mm

### SQUICH®-spring connection technology

#### WIRING

- Deeply insert a stripped conductor into a round terminal.
- Push the actuator button to close the terminal.

#### RE-OPENING

- Insert a 0,5 x 3,5 mm flat blade screwdriver in the actuator button side window and pull it up by levering down.



# CNE CSH-SQUICH® 10 poles + ⊕ 16A - 500V

<b>enclosures:</b> size "57.27"	page:
C-TYPE IP65/IP66	393 - 401
C7 IP67, two levers	438
V-TYPE IP65/IP66, single lever	448 - 453
BIG hoods	468 - 469
T-TYPE IP65 insulating	482 - 483
T-TYPE / W IP66 insulating	490
HYGIENIC T-TYPE / H IP66/IP69	502
HYGIENIC T-TYPE / C IP66/IP69, -50 °C	507
W-TYPE for aggressive environments	522
E-Xtreme® corrosion proof	532 - 533, 543, 552 - 553
EMC	579
Central lever	606 - 608
LS-TYPE	620 - 621
IP68	636 - 639
<b>panel supports:</b> COB	page: 652 - 653

## inserts, screw terminal connections

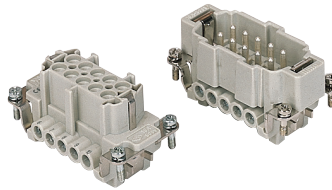

## inserts, spring terminal connections without tools

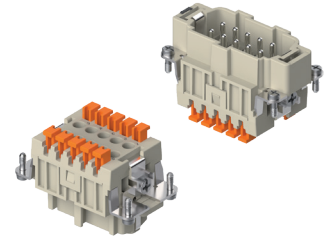

description	part No.	part No.
indirect, with plate <sup>1)</sup> female inserts with female contacts male inserts with male contacts	<b>CNEF 10 T</b> <b>CNEM 10 T</b>	
direct, without plate <sup>2)</sup> female inserts with female contacts male inserts with male contacts	<b>CNEF 10 TX</b> <b>CNEM 10 TX</b>	
spring terminals with actuator button female inserts with female contacts male inserts with male contacts		<b>CSHF 10</b> <b>CSHM 10</b>

- characteristics according to EN 61984:  
**16A 500V 6kV 3**  
**16A 400/690V 6kV 2**
- cULus (UL for USA and Canada),
- BUREAU VERITAS certified
- rated voltage according to UL/CSA: 600V
- insulation resistance: ≥ 10 GΩ
- ambient temperature limit: -40 °C ... +125 °C
- made of self-extinguishing thermoplastic resin UL 94V-0
- mechanical life: ≥ 500 cycles
- contact resistance: ≤ 1 mΩ (CNE) - ≤ 3 mΩ (CSH)
- for max. current load see the connector inserts derating diagrams below; for more information see page 28

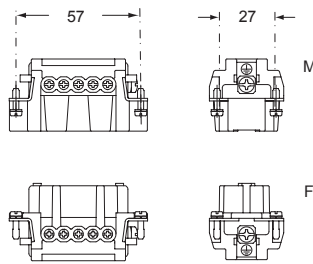

contacts side (front view)

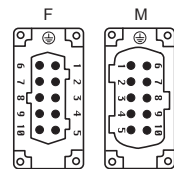

- inserts with plate for section conductors:  
0,5 - 4 mm<sup>2</sup> - AWG 20 - 12
- inserts without plate for section conductors:  
0,25 - 2,5 mm<sup>2</sup> - AWG 24 - 14
- conductors stripping length: 7 mm
- terminal screw torque: 0,5 Nm (4.4 lb.in), for more information see page 20 and 21

<sup>1)</sup> for unprepared conductors



<sup>2)</sup> for conductors with end sleeve ferrule

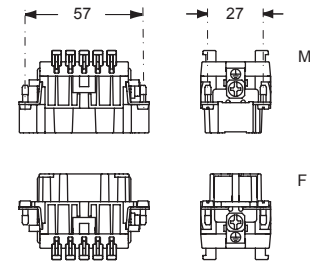

contacts side (front view)

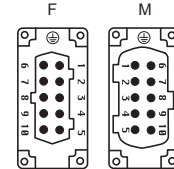

- inserts for connectors with the following sections:  
0,14 - 2,5 mm<sup>2</sup> - AWG 26 - 14
- conductors stripping length: 9...11 mm

### SQUICH®-spring connection technology WIRING

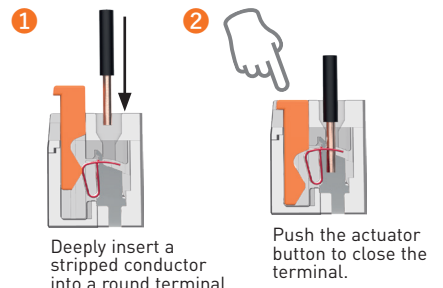

### RE-OPENING

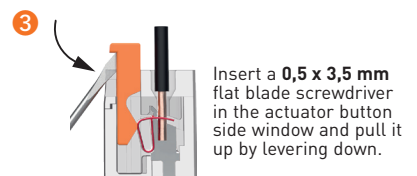

**CNE 10 poles connector inserts**  
Maximum current load derating diagram

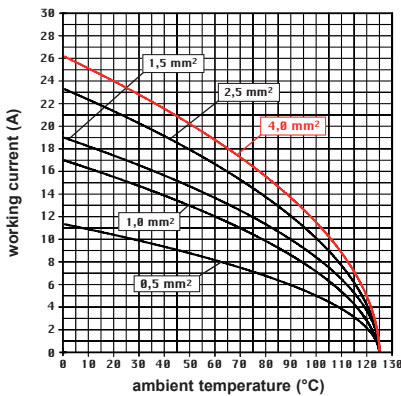

**CSH 10 poles connector inserts**  
Maximum current load derating diagram

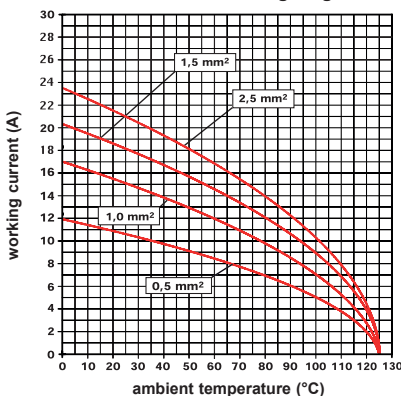

# CNE CSH-SQUICH® 16 poles + ⊕ 16A - 500V

<b>enclosures:</b> size "77.27"	<b>page:</b>
C-TYPE IP65/IP66	402 - 411
C7 IP67, two levers	439 - 440
V-TYPE IP65/IP66, single lever	454 - 458
BIG hoods	470 - 471
T-TYPE IP65 insulating	484 - 485
T-TYPE / W IP66 insulating	491
HYGIENIC T-TYPE / H IP66/IP69	503
HYGIENIC T-TYPE / C IP66/IP69, -50 °C	508
W-TYPE for aggressive environments	523
E-Xtreme® corrosion proof	534 - 535, 544, 554 - 555
EMC	580
Central lever	609 - 611
LS-TYPE	622 - 623
IP68	640 - 643
<b>panel supports:</b> COB	<b>page:</b> 652 - 653

**inserts,  
screw terminal connections**

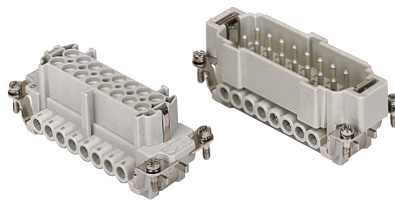

**inserts,  
spring terminal connections without tools**

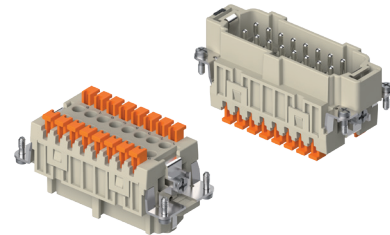

description	part No.	part No.
indirect, with plate <sup>1)</sup> female inserts with female contacts male inserts with male contacts	<b>CNEF 16 T</b> <b>CNEM 16 T</b>	
direct, without plate <sup>2)</sup> female inserts with female contacts male inserts with male contacts	<b>CNEF 16 TX</b> <b>CNEM 16 TX</b>	
spring terminals with actuator button female inserts with female contacts male inserts with male contacts		<b>CSHF 16</b> <b>CSHM 16</b>

- characteristics according to EN 61984:  
**16A 500V 6kV 3**  
**16A 400/690V 6kV 2**
- (UL for USA and Canada),
- certified
- rated voltage according to UL/CSA: 600V
- insulation resistance: ≥ 10 GΩ
- ambient temperature limit: -40 °C ... +125 °C
- made of self-extinguishing thermoplastic resin UL 94V-0
- mechanical life: ≥ 500 cycles
- contact resistance: ≤ 1 mΩ (CNE) - ≤ 3 mΩ (CSH)
- for max. current load see the connector inserts derating diagrams below; for more information see page 28

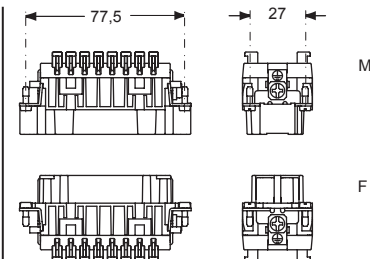
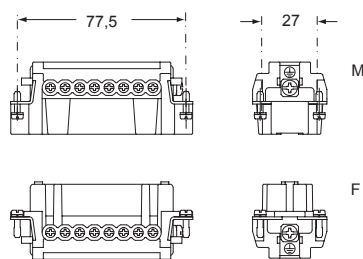

contacts side (front view)

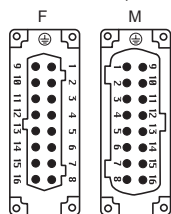

contacts side (front view)

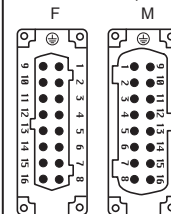

- inserts with plate for section conductors:  
0,5 - 4 mm<sup>2</sup> - AWG 20 - 12
- inserts without plate for section conductors:  
0,25 - 2,5 mm<sup>2</sup> - AWG 24 - 14
- conductors stripping length: 7 mm
- terminal screw torque: 0,5 Nm (4.4 lb.in), for more information see page 20 and 21

- inserts for connectors with the following sections:  
0,14 - 2,5 mm<sup>2</sup> - AWG 26 - 14
- conductors stripping length: 9...11 mm

**SQUICH®-spring connection technology  
WIRING**

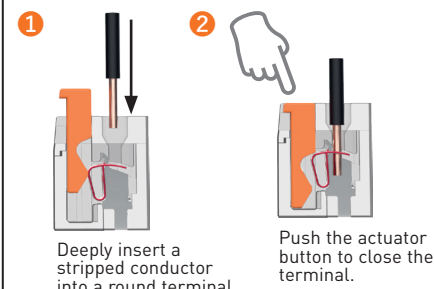

**RE-OPENING**

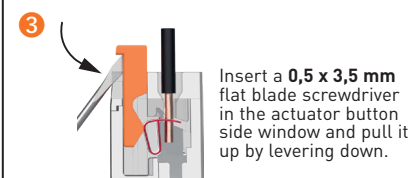

**CNE 16 poles connector inserts  
Maximum current load derating diagram**

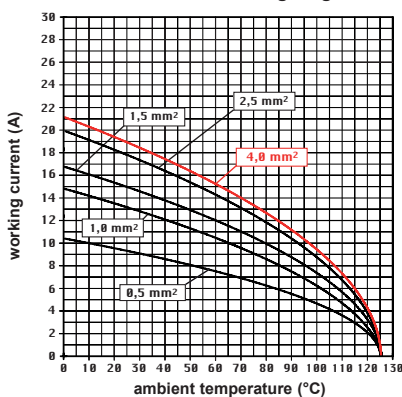

**CSH 16 poles connector inserts  
Maximum current load derating diagram**

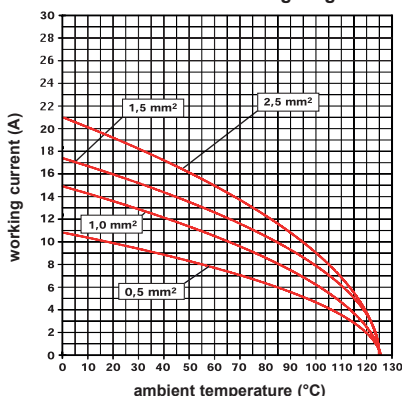

<sup>1)</sup> for unprepared conductors



<sup>2)</sup> for conductors with end sleeve ferrule



CNE CSH-SQUICH®

# CNE CSH-SQUICH® 24 poles + ⊕ 16A - 500V

enclosures: size "104.27"	page:
C-TYPE IP65/IP66	412 - 423
C7 IP67, two levers	441 - 442
V-TYPE IP65/IP66, single lever	459 - 463
BIG hoods	472 - 473
T-TYPE IP65 insulating	486 - 487
T-TYPE / W IP66 insulating	492
HYGIENIC T-TYPE / H IP66/IP69	504
HYGIENIC T-TYPE / C IP66/IP69, -50 °C	509
W-TYPE for aggressive environments	524
E-Xtreme® corrosion proof	536 - 537, 545, 556 - 557
EMC	581
Central lever	612 - 614
LS-TYPE	624 - 625
IP68	644 - 647
panel supports: COB	page: 652 - 653

## inserts, screw terminal connections

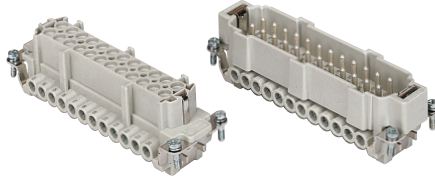

## inserts, spring terminal connections without tools

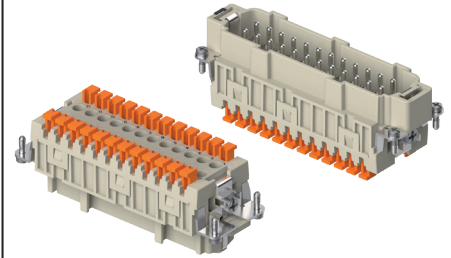

description	part No.	part No.
indirect, with plate <sup>1)</sup> female inserts with female contacts male inserts with male contacts	<b>CNEF 24 T</b> <b>CNEM 24 T</b>	
direct, without plate <sup>2)</sup> female inserts with female contacts male inserts with male contacts	<b>CNEF 24 TX</b> <b>CNEM 24 TX</b>	
spring terminals with actuator button female inserts with female contacts male inserts with male contacts		<b>CSHF 24</b> <b>CSHM 24</b>

- characteristics according to EN 61984:  
**16A 500V 6kV 3**  
**16A 400/690V 6kV 2**
- cULus (UL for USA and Canada), certified
- rated voltage according to UL/GSA: 600V
- insulation resistance: ≥ 10 GΩ
- ambient temperature limit: -40 °C ... +125 °C
- made of self-extinguishing thermoplastic resin UL 94V-0
- mechanical life: ≥ 500 cycles
- contact resistance: ≤ 1 mΩ (CNE) - ≤ 3 mΩ (CSH)
- for max. current load see the connector inserts derating diagrams below; for more information see page 28

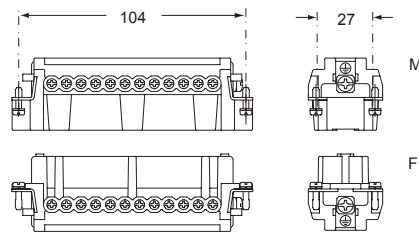

contacts side (front view)

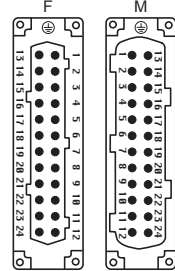

- inserts with plate for section conductors:  
0,5 - 4 mm<sup>2</sup> - AWG 20 - 12
- inserts without plate for section conductors:  
0,25 - 2,5 mm<sup>2</sup> - AWG 24 - 14
- conductors stripping length: 7 mm
- terminal screw torque: 0,5 Nm (4.4 lb.in), for more information see page 20 and 21

<sup>1)</sup> for unprepared conductors



<sup>2)</sup> for conductors with end sleeve ferrule

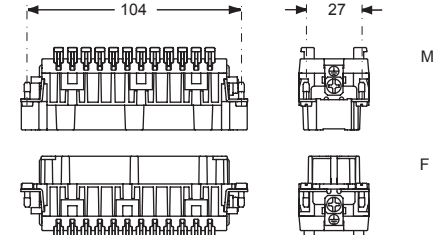

contacts side (front view)

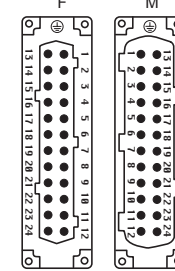

- inserts for connectors with the following sections:  
0,14 - 2,5 mm<sup>2</sup> - AWG 26 - 14
- conductors stripping length: 9...11 mm

### SQUICH®-spring connection technology

#### WIRING

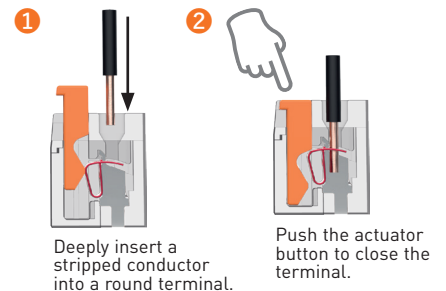

#### RE-OPENING

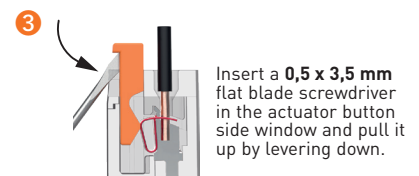

### CNE 24 poles connector inserts Maximum current load derating diagram

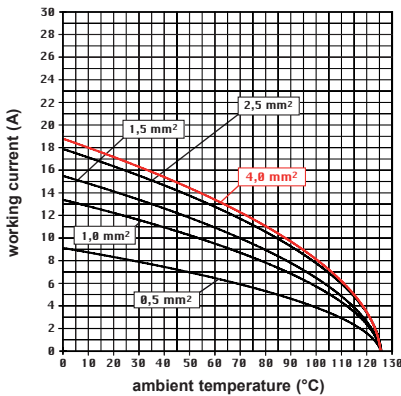

### CSH 24 poles connector inserts Maximum current load derating diagram

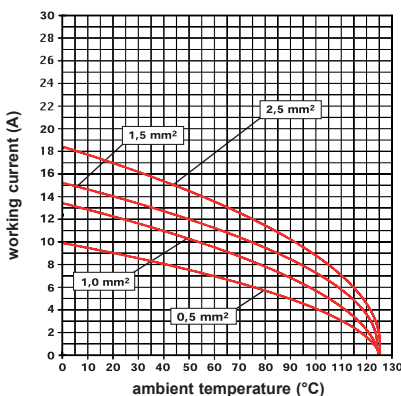

# CNE CSH-SQUICH® 32 poles + ⊕ 16A - 500V

enclosures:  
size "77.62"

page:

C-TYPE IP65/IP66  
W-TYPE for aggressive environments  
E-Xtreme® corrosion proof

424 - 429  
525  
546

inserts,  
screw terminal connections

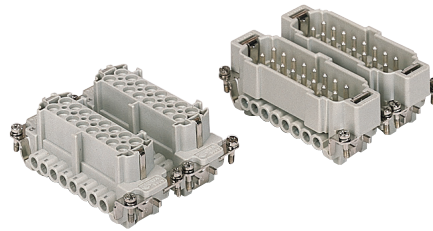

inserts,  
spring terminal connections without tools

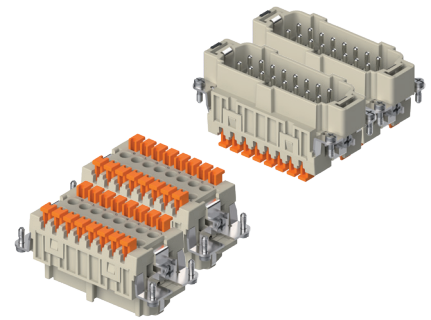

description	part No.	part No.	part No.	part No.
indirect, with plate <sup>1)</sup> female inserts, No. (1-16) and (17-32) male inserts, No. (1-16) and (17-32)	<b>CNEF 16 T</b> <b>CNEM 16 T</b>	<b>CNEF 16 TN</b> <b>CNEM 16 TN</b>		
direct, without plate <sup>2)</sup> female inserts, No. (1-16) and (17-32) male inserts, No. (1-16) and (17-32)	<b>CNEF 16 TX</b> <b>CNEM 16 TX</b>	<b>CNEF 16 TXN</b> <b>CNEM 16 TXN</b>		
spring terminals with actuator button female inserts with female contacts, No. (1-16) and (17-32) male inserts with male contacts, No. (1-16) and (17-32)			<b>CSHF 16</b> <b>CSHM 16</b>	<b>CSHF 16 N</b> <b>CSHM 16 N</b>

- characteristics according to EN 61984:  
**16A 500V 6kV 3**  
**16A 400/690V 6kV 2**
- (UL for USA and Canada), certified
- rated voltage according to UL/CSA: 600V
- insulation resistance: ≥ 10 GΩ
- ambient temperature limit: -40 °C ... +125 °C
- made of self-extinguishing thermoplastic resin UL 94V-0
- mechanical life: ≥ 500 cycles
- contact resistance: ≤ 1 mΩ (CNE) - ≤ 3 mΩ (CSH)
- for max. current load see the connector inserts derating diagrams below; for more information see page 28

**CNE 32 poles connector inserts**  
Maximum current load derating diagram

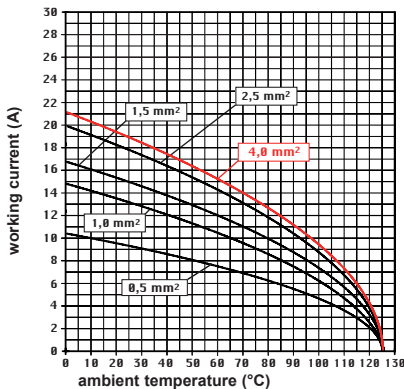

**CSH 32 poles connector inserts**  
Maximum current load derating diagram

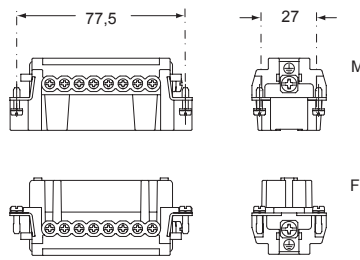
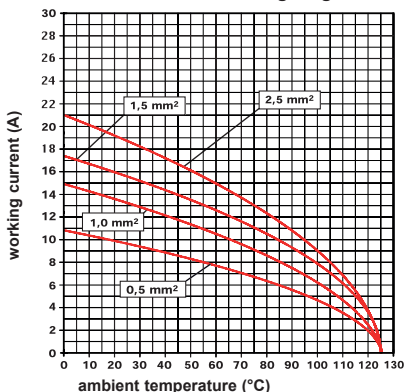

contacts side (front view)

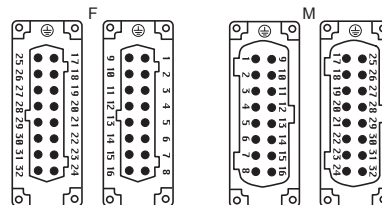

- inserts with plate for section conductors:  
0,5 - 4 mm² - AWG 20 - 12
- inserts without plate for section conductors:  
0,25 - 2,5 mm² - AWG 24 - 14
- conductors stripping length: 7 mm
- terminal screw torque: 0,5 Nm (4.4 lb.in), for more information see page 20 and 21

<sup>1)</sup> for unprepared conductors



<sup>2)</sup> for conductors with end sleeve ferrule

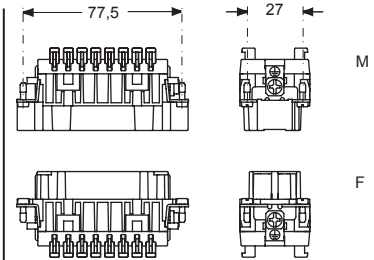

contacts side (front view)

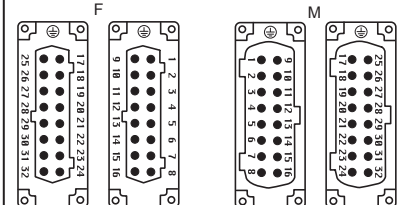

- inserts for connectors with the following sections:  
0,14 - 2,5 mm² - AWG 26 - 14
- conductors stripping length: 9...11 mm

**SQUICH®-spring connection technology**  
**WIRING**

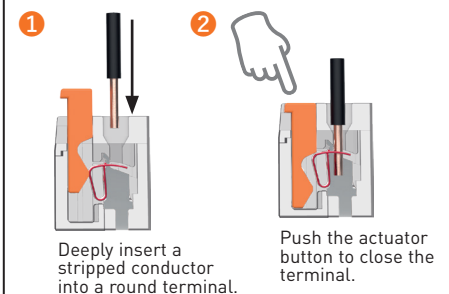

**RE-OPENING**

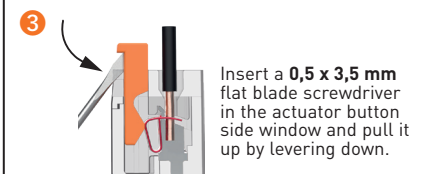

CNE CSH-SQUICH®



# CNE CSH-SQUICH® 48 poles + ⊕ 16A - 500V

enclosures:  
size "104.62"

page:

C-TYPE IP65/IP66  
W-TYPE for aggressive environments  
E-Xtreme® corrosion proof

430  
526  
547

inserts,  
screw terminal connections

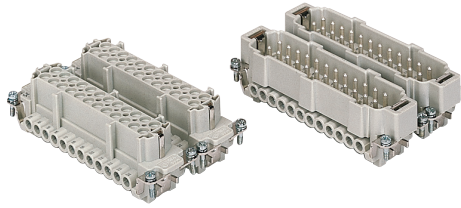

inserts,  
spring terminal connections without tools

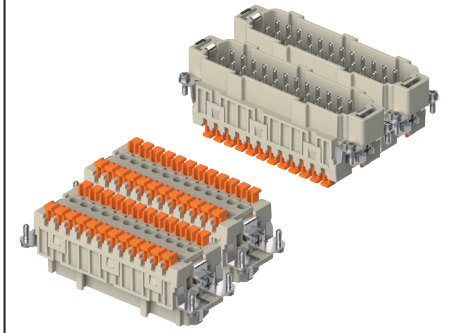

description	part No.	part No.	part No.	part No.
indirect, with plate <sup>1)</sup> female inserts, No. (1-24) and (25-48) male inserts, No. (1-24) and (25-48)	<b>CNEF 24 T</b> <b>CNEM 24 T</b>	<b>CNEF 24 TN</b> <b>CNEM 24 TN</b>		
direct, without plate <sup>2)</sup> female inserts, No. (1-24) and (25-48) male inserts, No. (1-24) and (25-48)	<b>CNEF 24 TX</b> <b>CNEM 24 TX</b>	<b>CNEF 24 TXN</b> <b>CNEM 24 TXN</b>		
spring terminals with actuator button female inserts with female contacts, No. (1-24) and (25-48) male inserts with male contacts, No. (1-24) and (25-48)			<b>CSHF 24</b> <b>CSHM 24</b>	<b>CSHF 24 N</b> <b>CSHM 24 N</b>

- characteristics according to EN 61984:  
**16A 500V 6kV 3**  
**16A 400/690V 6kV 2**
- certified
- rated voltage according to UL/CSA: 600V
- insulation resistance:  $\geq 10 \text{ G}\Omega$
- ambient temperature limit:  $-40 \text{ }^\circ\text{C} \dots +125 \text{ }^\circ\text{C}$
- made of self-extinguishing thermoplastic resin UL 94V-0
- mechanical life:  $\geq 500$  cycles
- contact resistance:  $\leq 1 \text{ m}\Omega$  (CNE) -  $\leq 3 \text{ m}\Omega$  (CSH)
- for max. current load see the connector inserts derating diagrams below; for more information see page 28

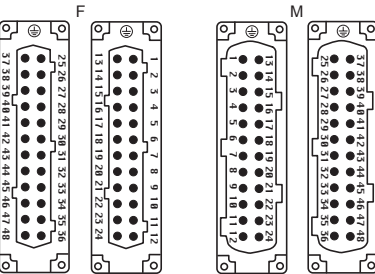
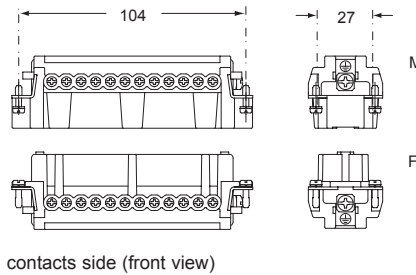

- inserts with plate for section conductors:  
0,5 - 4 mm<sup>2</sup> - AWG 20 - 12
- inserts without plate for section conductors:  
0,25 - 2,5 mm<sup>2</sup> - AWG 24 - 14
- conductors stripping length: 7 mm
- terminal screw torque: 0,5 Nm (4,4 lb.in), for more information see page 20 and 21

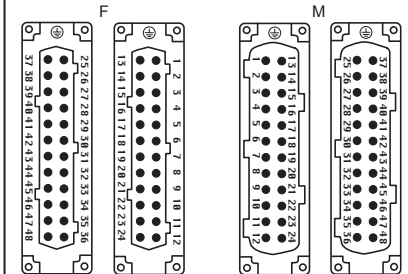
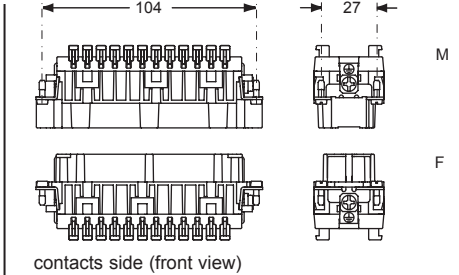

- inserts for connectors with the following sections:  
0,14 - 2,5 mm<sup>2</sup> - AWG 26 - 14
- conductors stripping length: 9...11 mm

**SQUICH®-spring connection technology**  
**WIRING**

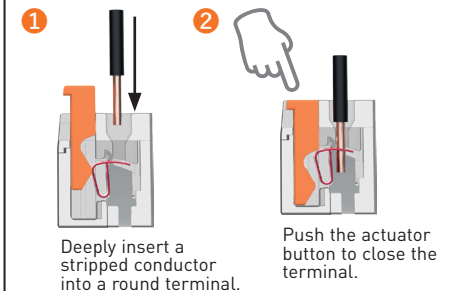

**RE-OPENING**

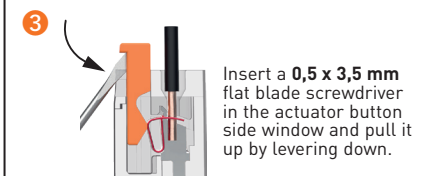

**CNE 48 poles connector inserts**  
**Maximum current load derating diagram**

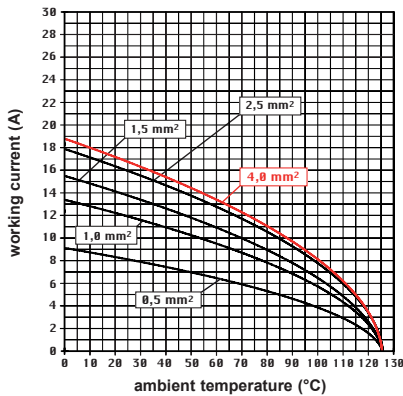

**CSH 48 poles connector inserts**  
**Maximum current load derating diagram**

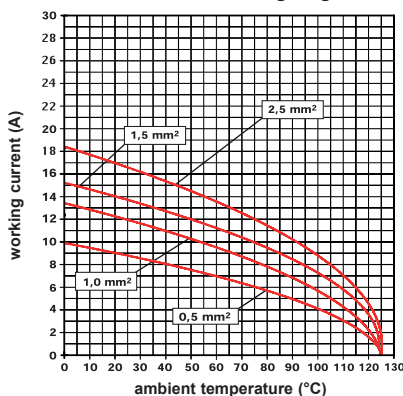

<sup>1)</sup> for unprepared conductors



<sup>2)</sup> for conductors with end sleeve ferrule



# CNE...RY 6 poles + ⊕ 16A - 500V

enclosures:  
size "44.27"  
for 180 °C

page:  
586

inserts,  
screw terminal connections

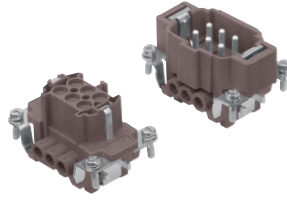

Q 180 °C

description

part No.

indirect, with plate <sup>1)</sup>, use in up to 180 °C  
female inserts with female contacts, brown  
male inserts with male contacts, brown

CNEF 06 RY  
CNEM 06 RY

- characteristics according to EN 61984:

**16A 500V 6kV 3**  
**16A 400/690V 6kV 2**

- cULus (UL for USA and Canada),

certified

- rated voltage according to UL/CSA: 600V
- insulation resistance: ≥ 10 GΩ
- ambient temperature limit: -40 °C ... +180 °C
- made of self-extinguishing thermoplastic resin UL 94V-0
- mechanical life: ≥ 500 cycles
- contact resistance: ≤ 1 mΩ
- for max. current load see the connector inserts derating diagram below; for more information see page 28

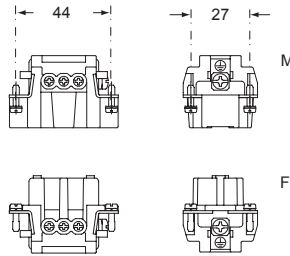

contacts side (front view)

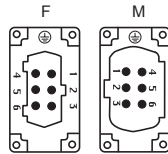

- inserts with plate for section conductors: 0,5 - 4 mm<sup>2</sup> - AWG 20 - 12
- conductors stripping length: 7 mm
- terminal screw torque: 0,5 Nm (4,4 lb.in), for more information see page 20 and 21

CNE...RY 06 poles connector inserts  
Maximum current load derating diagram

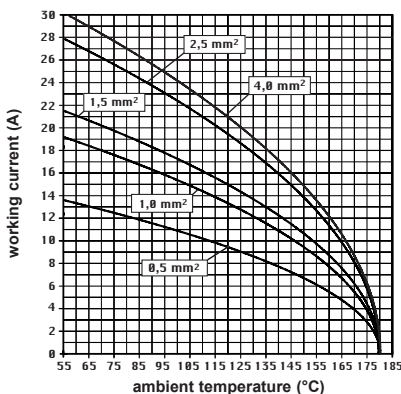

<sup>1)</sup> for unprepared conductors



CNE...RY



# CNE...RY 10 poles + ⊕ 16A - 500V

enclosures:  
size "57.27"  
for 180 °C

page:  
587

inserts,  
screw terminal connections

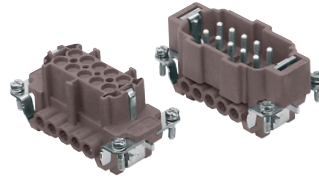

Q 180 °C

description

part No.

indirect, with plate <sup>1)</sup>, use in up to 180 °C  
female inserts with female contacts, brown  
male inserts with male contacts, brown

CNEF 10 RY  
CNEM 10 RY

- characteristics according to EN 61984:

**16A 500V 6kV 3**

**16A 400/690V 6kV 2**

- cULus (UL for USA and Canada),

certified

- rated voltage according to UL/CSA: 600V
- insulation resistance:  $\geq 10 \text{ G}\Omega$
- ambient temperature limit: -40 °C ... +180 °C
- made of self-extinguishing thermoplastic resin UL 94V-0
- mechanical life:  $\geq 500$  cycles
- contact resistance:  $\leq 1 \text{ m}\Omega$
- for max. current load see the connector inserts derating diagram below; for more information see page 28

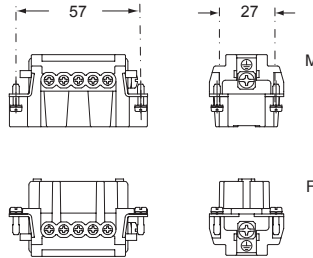

contacts side (front view)

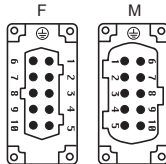

- inserts with plate for section conductors: 0,5 - 4 mm<sup>2</sup> - AWG 20 - 12
- conductors stripping length: 7 mm
- terminal screw torque: 0,5 Nm (4,4 lb.in), for more information see page 20 and 21

CNE...RY 10 poles connector inserts  
Maximum current load derating diagram

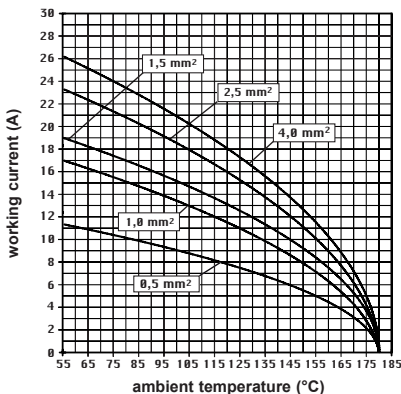

<sup>1)</sup> for unprepared conductors



# CNE...RY 16 poles + ⊕ 16A - 500V

enclosures:  
size "77.27"

page:

for 180 °C

588

inserts,  
screw terminal connections

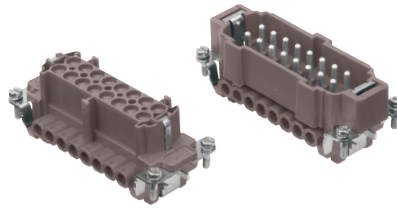

Q 180 °C

description

part No.

indirect, with plate <sup>1)</sup>, use in up to 180 °C  
female inserts with female contacts, brown  
male inserts with male contacts, brown

CNEF 16 RY  
CNEM 16 RY

- characteristics according to EN 61984:

**16A 500V 6kV 3**

**16A 400/690V 6kV 2**

- cULus (UL for USA and Canada), VDE, CEC, DNV-GL

BUREAU VERITAS EAC certified

- rated voltage according to UL/CSA: 600V

- insulation resistance: ≥ 10 GΩ

- ambient temperature limit: -40 °C ... +180 °C

- made of self-extinguishing thermoplastic resin  
UL 94V-0

- mechanical life: ≥ 500 cycles

- contact resistance: ≤ 1 mΩ

- for max. current load see the connector inserts derating  
diagram below; for more information see page 28

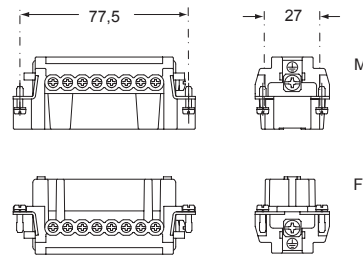

contacts side (front view)

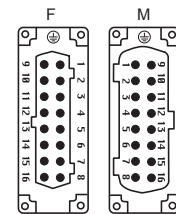

- inserts with plate for section conductors:  
0,5 - 4 mm<sup>2</sup> - AWG 20 - 12
- conductors stripping length: 7 mm
- terminal screw torque: 0,5 Nm (4,4 lb.in), for more  
information see page 20 and 21

<sup>1)</sup> for unprepared conductors



CNE...RY 16 poles connector inserts  
Maximum current load derating diagram

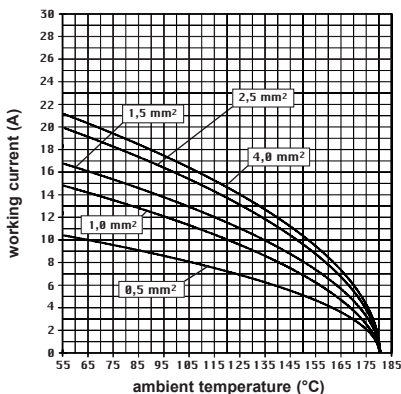

CNE...RY

# CNE...RY 24 poles + ⊕ 16A - 500V

enclosures:  
size "104.27"

page:

for 180 °C

589

inserts,  
screw terminal connections

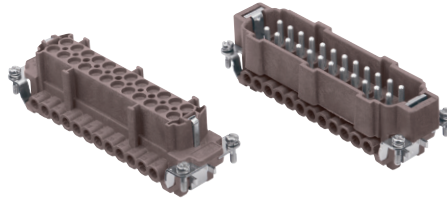

Q 180 °C

description

part No.

indirect, with plate <sup>1)</sup>, use in up to 180 °C  
female inserts with female contacts, brown  
male inserts with male contacts, brown

CNEF 24 RY  
CNEM 24 RY

- characteristics according to EN 61984:

**16A 500V 6kV 3**

**16A 400/690V 6kV 2**

- cULus (UL for USA and Canada),

certified

- rated voltage according to UL/CSA: 600V

- insulation resistance:  $\geq 10 \text{ G}\Omega$

- ambient temperature limit: -40 °C ... +180 °C

- made of self-extinguishing thermoplastic resin  
UL 94V-0

- mechanical life:  $\geq 500$  cycles

- contact resistance:  $\leq 1 \text{ m}\Omega$

- for max. current load see the connector inserts derating  
diagram below; for more information see page 28

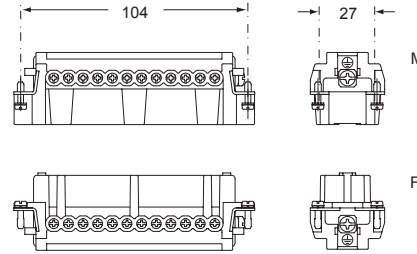

contacts side (front view)

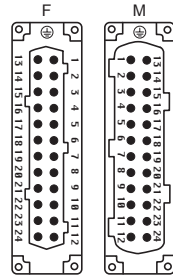

- inserts with plate for section conductors:

0,5 - 4 mm<sup>2</sup> - AWG 20 - 12

- conductors stripping length: 7 mm

- terminal screw torque: 0,5 Nm (4,4 lb.in), for more  
information see page 20 and 21

<sup>1)</sup> for unprepared conductors



CNE...RY 24 poles connector inserts  
Maximum current load derating diagram

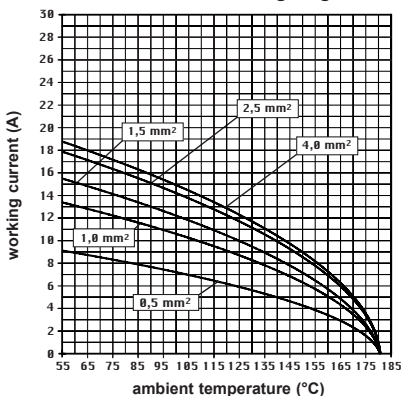

# CNE...RY 48 poles + ⊕ 16A - 500V

enclosures:  
size "104.62"

for 180 °C

page:

590

inserts,  
screw terminal connections

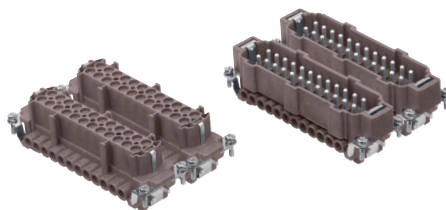

Q 180 °C

description

part No.

part No.

indirect, with plate <sup>1)</sup>, use in up to 180 °C  
female inserts, No. (1-24) and (25-48), brown  
male inserts, No. (1-24) and (25-48), brown

**CNEF 24 RY**  
**CNEM 24 RY**

**CNEF 24 RYN**  
**CNEM 24 RYN**

- characteristics according to EN 61984:

**16A 500V 6kV 3**

**16A 400/690V 6kV 2**

- cULus (UL for USA and Canada),

certified

- rated voltage according to UL/CSA: 600V
- insulation resistance:  $\geq 10 \text{ G}\Omega$
- ambient temperature limit: -40 °C ... +180 °C
- made of self-extinguishing thermoplastic resin UL 94V-0
- mechanical life:  $\geq 500$  cycles
- contact resistance:  $\leq 1 \text{ m}\Omega$
- for max. current load see the connector inserts derating diagram below; for more information see page 28

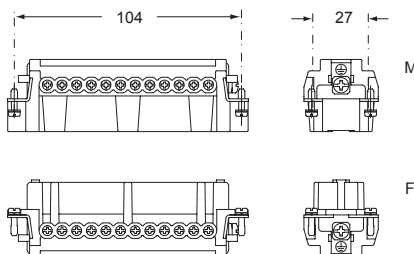

contacts side (front view)

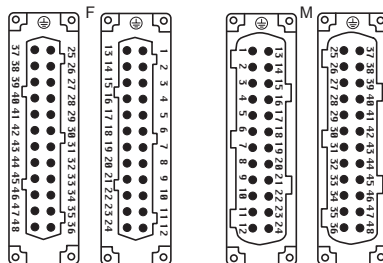

- inserts with plate for section conductors: 0,5 - 4 mm<sup>2</sup> - AWG 20 - 12
- conductors stripping length: 7 mm
- terminal screw torque: 0,5 Nm (4,4 lb.in), for more information see page 20 and 21

**CNE...RY 48 poles connector inserts**  
**Maximum current load derating diagram**

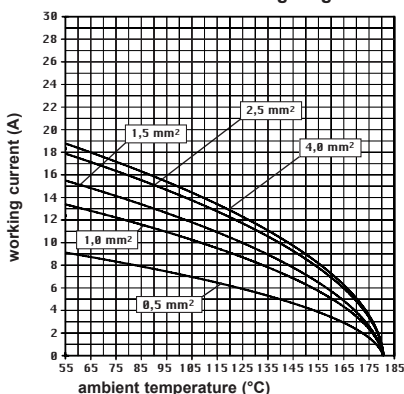

<sup>1)</sup> for unprepared conductors



CNE...RY

## CSH S-SQUICH® series

### TECHNICAL FEATURES

Demand for cost-effective solutions for large serial production is constantly growing and stamped contacts meet the basic needs for such applications.

- ILME stamped contacts, thanks to their **silver-plated** treatment are suitable for up to **500 mating cycles**, consistently with the turned ones.



**Q** In order to easily recognize them, each insert is marked with an “S” at the end of the product code, meaning “stamped”.

- Stamped contacts applied to the SQUICH® connection feature all the well-known advantages of the ILME proprietary technology:

- **reduced wiring time** (spring-clamp terminals are presented “open”, with the actuator button lifted up); up to **50% saving time** compared to screw connection;
- **operator skill independence** (no need to open the spring-clamp terminals by direct operation of a possibly unsuitable tool on the spring);
- **no special wire preparation** (only stripping at the correct length);
- no wiring tool needed;
- **resistance to strong vibrations** typical of the self-compensating spring-clamp technology;
- possibility **to use solid and flexible** stranded copper conductors with range of cross sectional area between 0,14 mm<sup>2</sup> and 2,5 mm<sup>2</sup> (26 – 14 AWG);
- possibility to insert the **test probe** of a measurement instrument in the cavity of the actuator button (proprietary design);
- simple re-opening of a terminal (if needed) using a flat blade screwdriver on the actuator button dedicated side window.

stamped  
silver-plated  
contacts

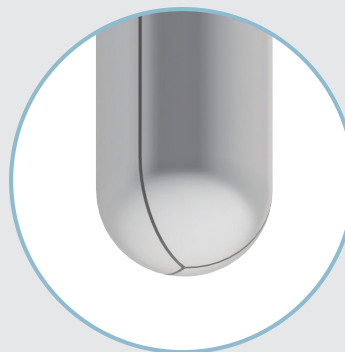
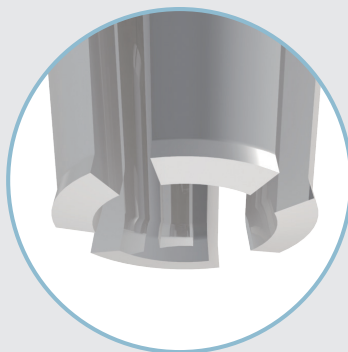

**CSHF/M 06 S 6 poles + ⊕ 16A - 500V SQUICH®**

enclosures: size "44.27"	page:
C-TYPE IP65/IP66	387 - 392
C7 IP67, single lever	436 - 437
V-TYPE IP65/IP66, single lever	444 - 447
BIG hoods	466 - 467
T-TYPE IP65 insulating	480 - 481
T-TYPE / W IP66 insulating	489
HYGIENIC T-TYPE / H IP66/IP69	501
HYGIENIC T-TYPE / C IP66/IP69, -50 °C	506
W-TYPE for aggressive environments	521
E-Xtreme® corrosion proof	530 - 531, 542, 550 - 551
EMC	578
Central lever	603 - 605
LS-TYPE	618 - 619
IP68	632 - 635
panel supports:	page:
COB	652 - 653

inserts,  
spring terminal connections

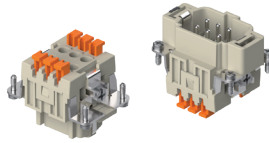

**Q STAMPED CONTACTS, SILVER PLATED**  
**AVAILABLE NOVEMBER 2019**

description	part No.
-------------	----------

spring terminals with actuator button  
female inserts with female contacts  
male inserts with male contacts

**CSHF 06 S**  
**CSHM 06 S**

- characteristics according to EN 61984:  
**16A 500V 6kV 3**  
**16A 400/690V 6kV 2**
- cURus, CSA, CQC, DNV-GL, BV, EAC pending
- rated voltage according to UL/CSA: 600V
- insulation resistance: ≥ 10 GΩ
- ambient temperature limit: -40 °C ... +125 °C
- made of self-extinguishing thermoplastic resin UL 94V-0
- mechanical life: ≥ 500 cycles
- contact resistance: ≤ 3 mΩ

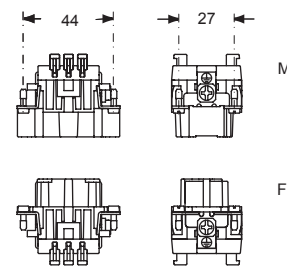

contacts side (front view)

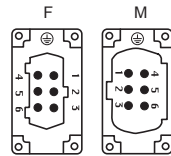

- inserts for connectors with the following conductor cross-sectional areas: 0,14 - 2,5 mm<sup>2</sup> - AWG 26 - 14
- conductors stripping length: 9...11 mm

**SQUICH®-spring connection technology**

**WIRING**

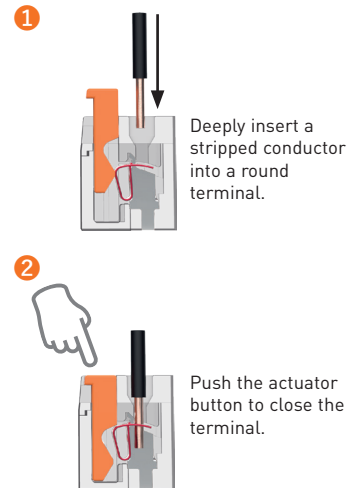

**RE-OPENING**

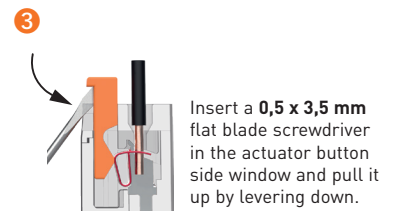



# CSHF/M 10 S 10 poles + ⊕ 16A - 500V SQUICH®

enclosures: size "57.27"	page:
C-TYPE IP65/IP66	393 - 401
C7 IP67, two levers	438
V-TYPE IP65/IP66, single lever	448 - 453
BIG hoods	468 - 469
T-TYPE IP65 insulating	482 - 483
T-TYPE / W IP66 insulating	490
HYGIENIC T-TYPE / H IP66/IP69	502
HYGIENIC T-TYPE / C IP66/IP69, -50 °C	507
W-TYPE for aggressive environments	522
E-Xtreme® corrosion proof	532 - 533, 543, 552 - 553
EMC	579
Central lever	606 - 608
LS-TYPE	620 - 621
IP68	636 - 639
panel supports:	page:
COB	652 - 653

## inserts, spring terminal connections

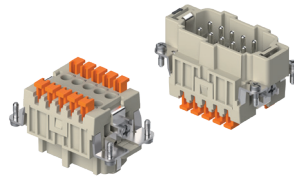

**Q STAMPED CONTACTS, SILVER PLATED**  
**📅 AVAILABLE NOVEMBER 2019**

description	part No.
-------------	----------

spring terminals with actuator button  
 female inserts with female contacts  
 male inserts with male contacts

**CSHF 10 S**  
**CSHM 10 S**

- characteristics according to EN 61984:  
**16A 500V 6kV 3**  
**16A 400/690V 6kV 2**
- cURus, CSA, CQC, DNV-GL, BV, EAC pending
- rated voltage according to UL/CSA: 600V
- insulation resistance:  $\geq 10 \text{ G}\Omega$
- ambient temperature limit:  $-40 \text{ }^\circ\text{C} \dots +125 \text{ }^\circ\text{C}$
- made of self-extinguishing thermoplastic resin  
 UL 94V-0
- mechanical life:  $\geq 500$  cycles
- contact resistance:  $\leq 3 \text{ m}\Omega$

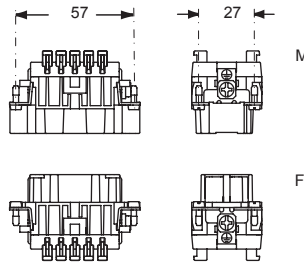

contacts side (front view)

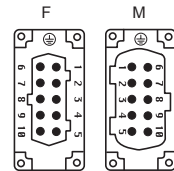

- inserts for connectors with the following conductor cross-sectional areas:  $0,14 - 2,5 \text{ mm}^2$  - AWG 26 - 14
- conductors stripping length: 9...11 mm

### SQUICH®-spring connection technology

#### WIRING

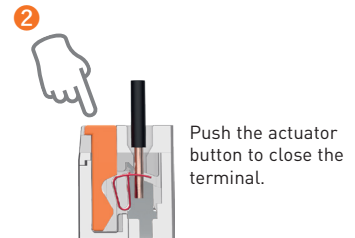
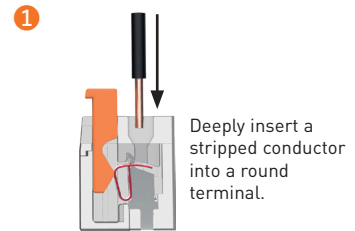

#### RE-OPENING

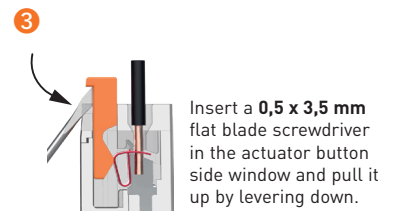

# CSHF/M 16 S 16 poles + ⊕ 16A - 500V SQUICH®

enclosures: size "77.27"	page:
C-TYPE IP65/IP66	402 - 411
C7 IP67, two levers	439 - 440
V-TYPE IP65/IP66, single lever	454 - 458
BIG hoods	470 - 471
T-TYPE IP65 insulating	484 - 485
T-TYPE / W IP66 insulating	491
HYGIENIC T-TYPE / H IP66/IP69	503
HYGIENIC T-TYPE / C IP66/IP69, -50 °C	508
W-TYPE for aggressive environments	523
E-Xtreme® corrosion proof	534 - 535, 544, 554 - 555
EMC	580
Central lever	609 - 611
LS-TYPE	622 - 623
IP68	640 - 643
panel supports: COB	page: 652 - 653

## inserts, spring terminal connections

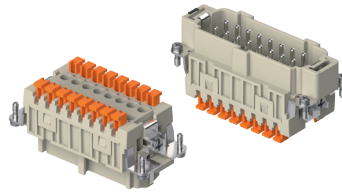

**Q STAMPED CONTACTS, SILVER PLATED**  
**AVAILABLE NOVEMBER 2019**

description	part No.
-------------	----------

spring terminals with actuator button  
 female inserts with female contacts  
 male inserts with male contacts

**CSHF 16 S**  
**CSHM 16 S**

- characteristics according to EN 61984:  
**16A 500V 6kV 3**  
**16A 400/690V 6kV 2**
- cURus, CSA, CQC, DNV-GL, BV, EAC pending
- rated voltage according to UL/CSA: 600V
- insulation resistance:  $\geq 10 \text{ G}\Omega$
- ambient temperature limit:  $-40 \text{ }^\circ\text{C} \dots +125 \text{ }^\circ\text{C}$
- made of self-extinguishing thermoplastic resin  
 UL 94V-0
- mechanical life:  $\geq 500$  cycles
- contact resistance:  $\leq 3 \text{ m}\Omega$

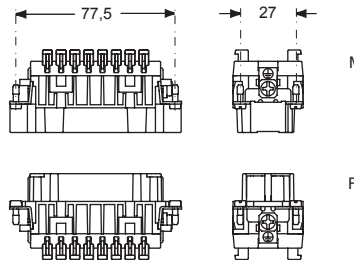

contacts side (front view)

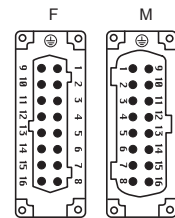

- inserts for connectors with the following conductor cross-sectional areas:  $0,14 - 2,5 \text{ mm}^2$  - AWG 26 - 14
- conductors stripping length: 9...11 mm

### SQUICH®-spring connection technology

#### WIRING

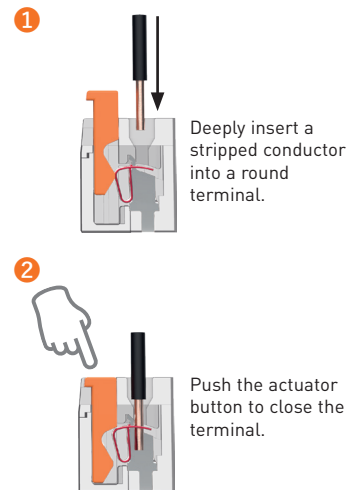

#### RE-OPENING

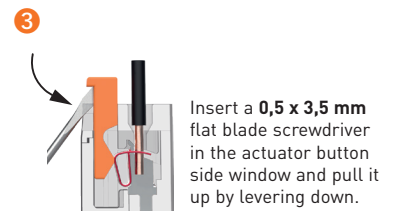

CSH S-SQUICH®

# CSHF/M 24 S 24 poles + ⊕ 16A - 500V SQUICH®

enclosures: size "104.27"	page:
C-TYPE IP65/IP66	412 - 423
C7 IP67, two levers	441 - 442
V-TYPE IP65/IP66, single lever	459 - 463
BIG hoods	472 - 473
T-TYPE IP65 insulating	486 - 487
T-TYPE / W IP66 insulating	492
HYGIENIC T-TYPE / H IP66/IP69	504
HYGIENIC T-TYPE / C IP66/IP69, -50 °C	509
W-TYPE for aggressive environments	524
E-Xtreme® corrosion proof	536 - 537, 545, 556 - 557
EMC	581
Central lever	612 - 614
LS-TYPE	624 - 625
IP68	644 - 647
panel supports:	page:
COB	652 - 653

## inserts, spring terminal connections

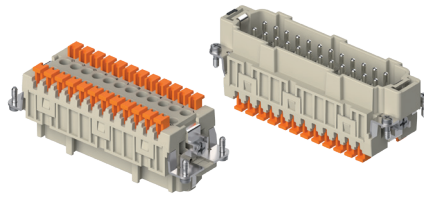

**Q STAMPED CONTACTS, SILVER PLATED**  
**📅 AVAILABLE NOVEMBER 2019**

description	part No.
-------------	----------

spring terminals with actuator button  
 female inserts with female contacts  
 male inserts with male contacts

**CSHF 24 S**  
**CSHM 24 S**

- characteristics according to EN 61984:  
**16A 500V 6kV 3**  
**16A 400/690V 6kV 2**
- cURus, CSA, CQC, DNV-GL, BV, EAC pending
- rated voltage according to UL/CSA: 600V
- insulation resistance:  $\geq 10 \text{ G}\Omega$
- ambient temperature limit:  $-40 \text{ }^\circ\text{C} \dots +125 \text{ }^\circ\text{C}$
- made of self-extinguishing thermoplastic resin  
 UL 94V-0
- mechanical life:  $\geq 500$  cycles
- contact resistance:  $\leq 3 \text{ m}\Omega$

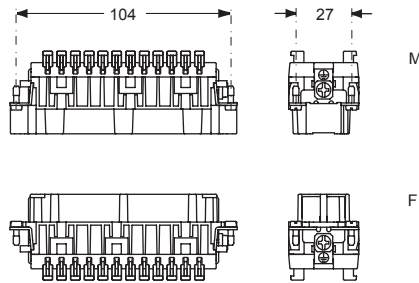

contacts side (front view)

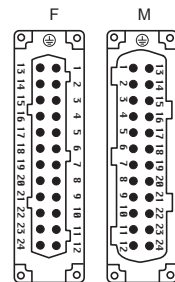

- inserts for connectors with the following conductor cross-sectional areas:  $0,14 - 2,5 \text{ mm}^2$  - AWG 26 - 14
- conductors stripping length: 9...11 mm

### SQUICH®-spring connection technology

#### WIRING

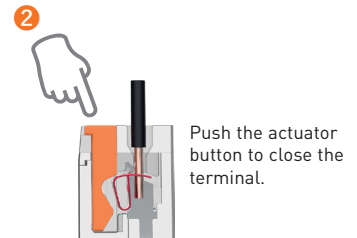
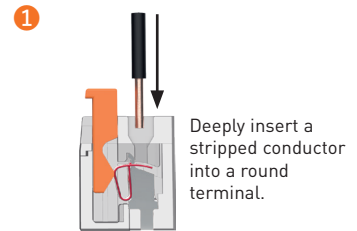

#### RE-OPENING

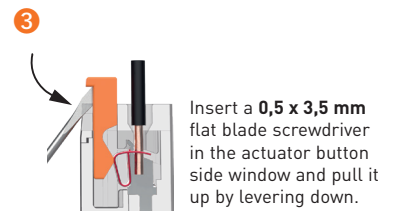

# CSHF/M SN 32 poles + ⊕ 16A - 500V SQUICH®

enclosures:  
size "77.62"

page:

C-TYPE IP65/IP66  
W-TYPE for aggressive environments  
E-Xtreme® corrosion proof

424 - 429  
525  
546

inserts,  
spring terminal connections

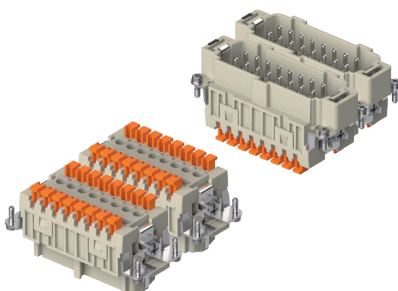

**Q STAMPED CONTACTS, SILVER PLATED**  
**📅 AVAILABLE NOVEMBER 2019**

description

part No.

part No.

spring terminals with actuator button  
female inserts with female contacts, No. (1-16) & (17-32)  
male inserts with male contacts, No. (1-16) & (17-32)

**CSHF 16 S**  
**CSHM 16 S**

**CSHF 16 SN**  
**CSHM 16 SN**

- characteristics according to EN 61984:  
**16A 500V 6kV 3**  
**16A 400/690V 6kV 2**
- cURus, CSA, CQC, DNV-GL, BV, EAC pending
- rated voltage according to UL/CSA: 600V
- insulation resistance:  $\geq 10 \text{ G}\Omega$
- ambient temperature limit:  $-40 \text{ }^\circ\text{C} \dots +125 \text{ }^\circ\text{C}$
- made of self-extinguishing thermoplastic resin UL 94V-0
- mechanical life:  $\geq 500$  cycles
- contact resistance:  $\leq 3 \text{ m}\Omega$

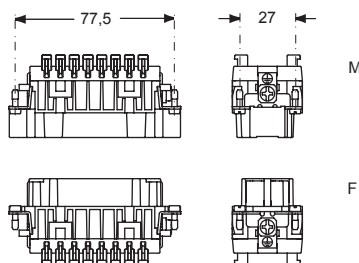

contacts side (front view)

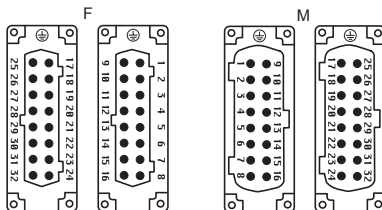

- inserts for connectors with the following conductor cross-sectional areas:  $0,14 - 2,5 \text{ mm}^2$  - AWG 26 - 14
- conductors stripping length: 9...11 mm

### SQUICH®-spring connection technology

#### WIRING

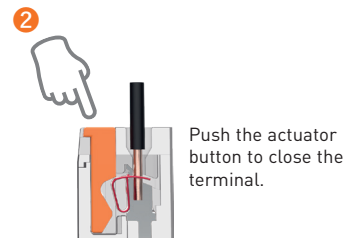
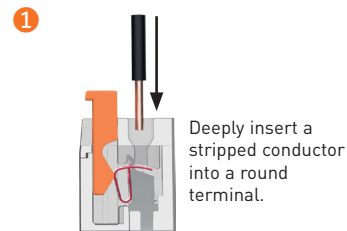

#### RE-OPENING

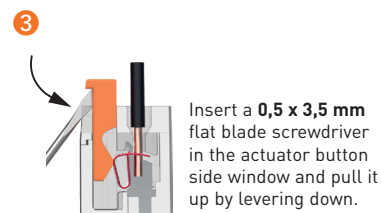

# CSHF/M SN 48 poles + ⊕ 16A - 500V SQUICH®

enclosures:  
size "104.62"

page:

C-TYPE IP65/IP66  
W-TYPE for aggressive environments  
E-Xtreme® corrosion proof

430  
526  
547

inserts,  
spring terminal connections

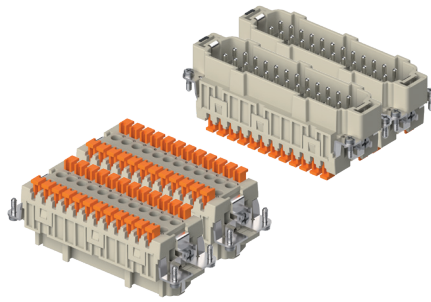

**Q STAMPED CONTACTS, SILVER PLATED**  
**📅 AVAILABLE NOVEMBER 2019**

description	part No.	part No.
-------------	----------	----------

spring terminals with actuator button  
female inserts with female contacts, No. (1-24) & (25-48)  
male inserts with male contacts, No. (1-24) & (25-48)

<b>CSHF 24 S</b> <b>CSHM 24 S</b>	<b>CSHF 24 SN</b> <b>CSHM 24 SN</b>
--------------------------------------	--

- characteristics according to EN 61984:  
**16A 500V 6kV 3**  
**16A 400/690V 6kV 2**
- cURus, CSA, CQC, DNV-GL, BV, EAC pending
- rated voltage according to UL/CSA: 600V
- insulation resistance:  $\geq 10 \text{ G}\Omega$
- ambient temperature limit:  $-40 \text{ }^\circ\text{C} \dots +125 \text{ }^\circ\text{C}$
- made of self-extinguishing thermoplastic resin UL 94V-0
- mechanical life:  $\geq 500$  cycles
- contact resistance:  $\leq 3 \text{ m}\Omega$

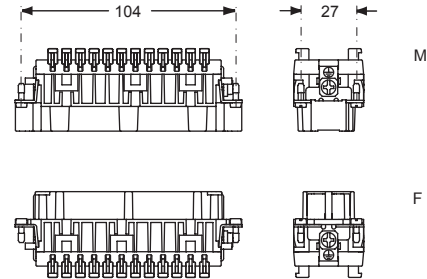

contacts side (front view)

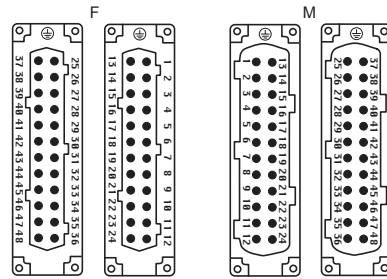

- inserts for connectors with the following conductor cross-sectional areas: 0,14 - 2,5 mm<sup>2</sup> - AWG 26 - 14
- conductors stripping length: 9...11 mm

### SQUICH®-spring connection technology

#### WIRING

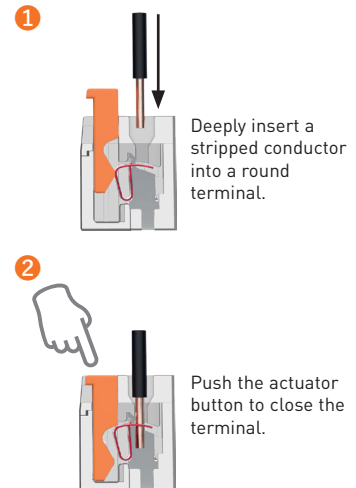

#### RE-OPENING

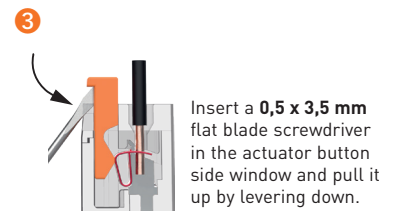

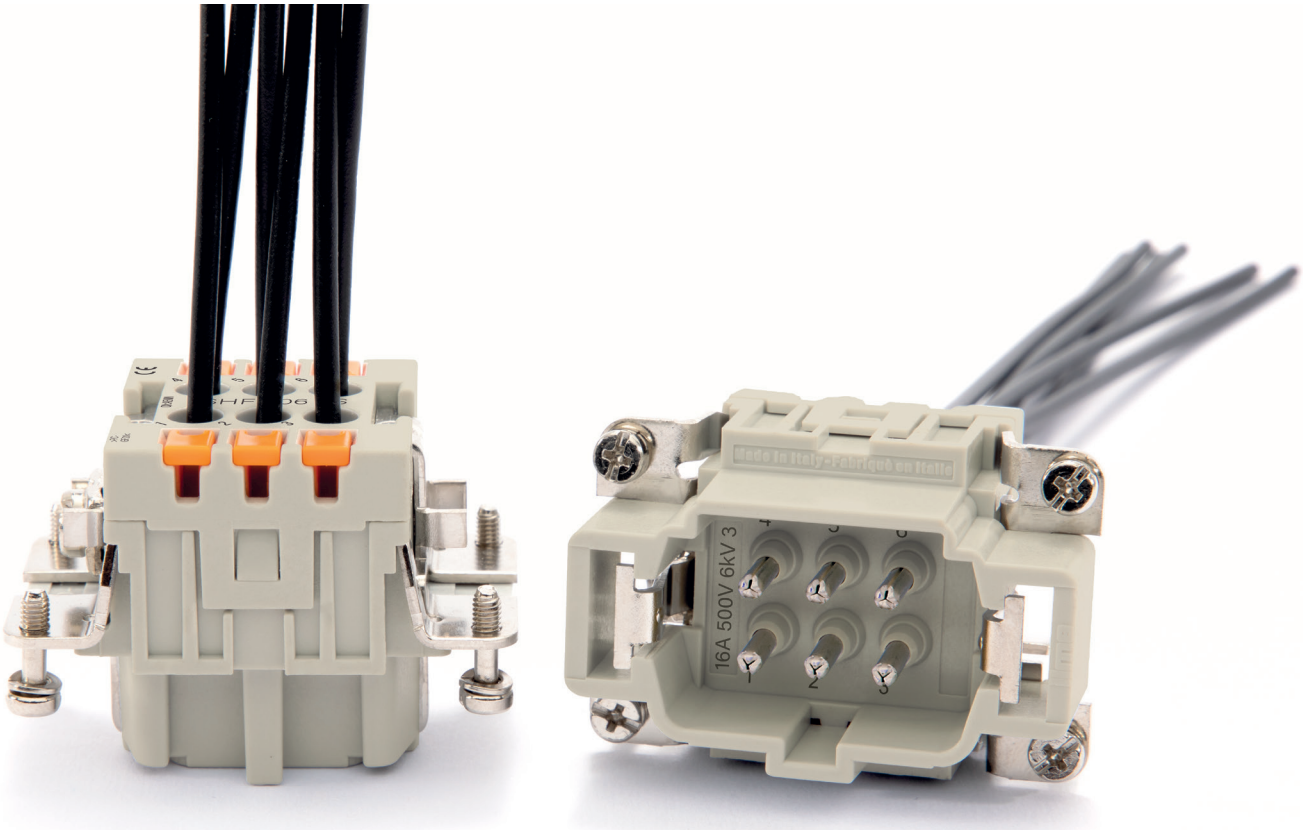



# CCE series

## TECHNICAL FEATURES

**CCE series** are the evolution of former CC series for removable crimp contacts CC series, with rated current up to 16A per pole.

It shares the four (six with double inserts) mating interfaces with series: **CNE** (screw-type), **CSH** (spring-type with actuator button, SQUICH® technology), **CSS** (double spring-type), CT (screw-type with 45° terminal block), **CTSE** (spring-type with 45° terminal block).

As for CNE series with former CN series, also CCE series are the result of a complete overhaul of the preceding CC series. Whereas CC series relied upon additional stainless steel spring element to perform contact retention, CCE series applies the modern and equally reliable concept of retention in the insulating body by a resilient element directly obtained in the contact holder. This enhances insulation, simplifies manufacturing and improves reliability.

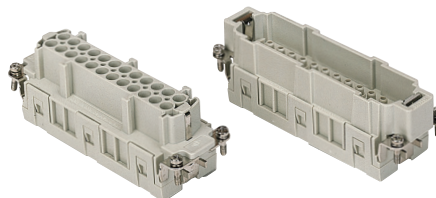

CCE series, through increase of creepage distances, attains as well the **rated voltage increase to 500V from previous 400V value.**

Solid machined crimp contacts and the relevant connector inserts are the preferred option in fields of application subject to high vibration levels, such as railway rolling stock and everywhere transportation and moving parts are foreseen with e.g. motors as potential source of vibration.

Insert series		CCE
No. of poles <sup>1)</sup>	Main contacts + ⊕ auxiliary contacts	<b>6, 10, 16, 24, (32 = 2x16), (48 = 2x24)</b> —
Rated current <sup>2)</sup>		16A
EN IEC 61984 Pollution degree 3	rated voltage rated impulse voltage <b>pollution degree</b>	500V 6kV <b>3</b>
EN IEC 61984 Pollution degree 2	rated voltage rated impulse voltage <b>pollution degree</b>	400/690V 6kV <b>2</b>
UL / CSA certification	rated voltage (a.c./d.c.)	600V
Contact resistance		≤ 1 mΩ
Insulation resistance		≥ 10 GΩ
Ambient temperature limit (°C)	min max	-40 °C 70 °C
Degree of protection	with enclosures without enclosures - termination side on male and female inserts - mating side on female inserts	<b>IP65, IP66/IP69, IP66/IP67/IP69, IP66/IP68/IP69</b> (according to type and model) <b>IP20 (IPXXB)</b>
Conductor connections		crimp
Conductor cross-sectional area	mm <sup>2</sup> AWG	0,14 - 4 26 - 12
Mechanical endurance (mating cycles)		≥ 500

1) Polarities shown in brackets may be obtained by using two inserts in their own double-sized housings

2) Please check the inserts derating diagrams to establish the actual maximum operating current according to the ambient temperature, the conductor cross-sectional area, the polarity of the connector, and any external constraint may derive e.g. by the continuous operating temperature sustained by the chosen conductor sheathing or by end-product safety standards fixing max allowed temperature rise on terminals (e.g. 30 K, 45 K or 50 K)

# CCE 6 poles + ⊕ 16A - 500V

enclosures: size "44.27"	page:
C-TYPE IP65/IP66	387 - 392
C7 IP67, single lever	436 - 437
V-TYPE IP65/IP66, single lever	444 - 447
BIG hoods	466 - 467
T-TYPE IP65 insulating	480 - 481
T-TYPE / W IP66 insulating	489
HYGIENIC T-TYPE / H IP66/IP69	501
HYGIENIC T-TYPE / C IP66/IP69, -50 °C	506
W-TYPE for aggressive environments	521
E-Xtreme® corrosion proof	530 - 531, 542, 550 - 551
EMC	578
Central lever	603 - 605
LS-TYPE	618 - 619
IP68	632 - 635
panel supports: COB	page: 652 - 653

inserts, crimp connections



16A crimp contacts  
standard or for advanced opening  
silver and gold plated

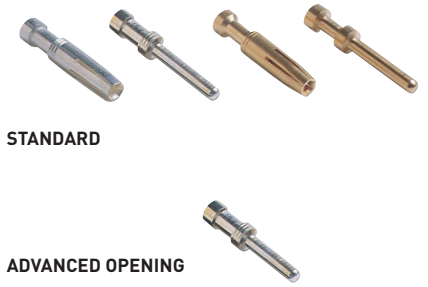

description	part No.	part No.
-------------	----------	----------

without contacts (to be ordered separately)  
female inserts for female contacts  
male inserts for male contacts

CCEF 06  
CCEM 06

16A female contacts

0,14-0,37 mm <sup>2</sup>	AWG 26-22	one groove
0,5 mm <sup>2</sup>	AWG 20	with no grooves
0,75 mm <sup>2</sup>	AWG 18	one groove (back side)
1 mm <sup>2</sup>	AWG 18	one groove
1,5 mm <sup>2</sup>	AWG 16	two grooves
2,5 mm <sup>2</sup>	AWG 14	three grooves
3 mm <sup>2</sup>	AWG 12	one wide groove
4 mm <sup>2</sup>	AWG 12	with no grooves

CCFA 0.3  
CCFA 0.5  
CCFA 0.7  
CCFA 1.0  
CCFA 1.5  
CCFA 2.5  
CCFA 3.0  
CCFA 4.0

silver plated

CCFD 0.3  
CCFD 0.5  
CCFD 0.7  
CCFD 1.0  
CCFD 1.5  
CCFD 2.5  
CCFD 3.0  
CCFD 4.0

gold plated+

16A male contacts

0,14-0,37 mm <sup>2</sup>	AWG 26-22	one groove
0,5 mm <sup>2</sup>	AWG 20	with no grooves
0,75 mm <sup>2</sup>	AWG 18	one groove (back side)
1 mm <sup>2</sup>	AWG 18	one groove
1,5 mm <sup>2</sup>	AWG 16t	wo grooves
2,5 mm <sup>2</sup>	AWG 14	three grooves
3 mm <sup>2</sup>	AWG 12	one wide groove
4 mm <sup>2</sup>	AWG 12	with no grooves

CCMA 0.3  
CCMA 0.5  
CCMA 0.7  
CCMA 1.0  
CCMA 1.5  
CCMA 2.5  
CCMA 3.0  
CCMA 4.0

CCMD 0.3  
CCMD 0.5  
CCMD 0.7  
CCMD 1.0  
CCMD 1.5  
CCMD 2.5  
CCMD 3.0  
CCMD 4.0

16A male crimp contacts for advanced opening

0,5 mm <sup>2</sup>	AWG 20	with no grooves
0,75 mm <sup>2</sup>	AWG 18	one groove (back side)
1 mm <sup>2</sup>	AWG 18	one groove
1,5 mm <sup>2</sup>	AWG 16	two grooves
2,5 mm <sup>2</sup>	AWG 14	three grooves

CC 0.5 AN  
CC 0.7 AN  
CC 1.0 AN  
CC 1.5 AN  
CC 2.5 AN

\* for basic or high thickness gold plating, please refer to page 675

- characteristics according to EN 61984:

**16A 500V 6kV 3**  
**16A 400/690V 6kV 2**

- certified
- rated voltage according to UL/CSA: 600V
- insulation resistance: ≥ 10 GΩ
- ambient temperature limit: -40 °C ... +125 °C
- made of self-extinguishing thermoplastic resin UL 94V-0
- mechanical life: ≥ 500 cycles
- contact resistance: ≤ 1 mΩ
- for max. current load see the connector inserts derating diagram below; for more information see page 28

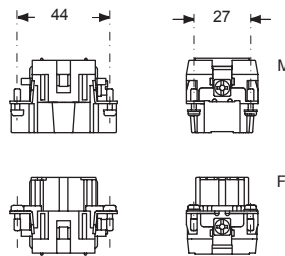

contacts side (front view)

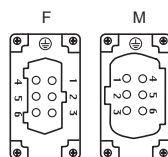

CCF and CCM

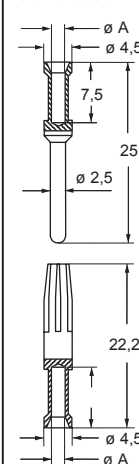

CC...AN

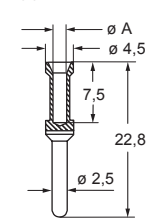

CCF, CCM and CC...AN contacts

conductor section mm <sup>2</sup>	conductor slot Ø A (mm)	conductors stripping length (mm)
0,14-0,37	0,9	7,5
0,5	1,1	7,5
0,75	1,3	7,5
1,0	1,45	7,5
1,5	1,8	7,5
2,5	2,2	7,5
3	2,55	7,5
4	2,85	7,5

CCE 06 poles connector inserts  
Maximum current load derating diagram

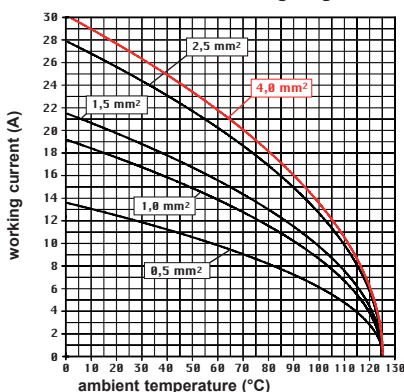

- it is recommended to crimp the contacts with crimping tools homologated by ILME (please see the crimping tool section 16A contacts, CCF, CCM and CC...AN series on pages 705 - 741)

# CCE 10 poles + ⊕ 16A - 500V

enclosures: size "57.27"	page:
C-TYPE IP65/IP66	393 - 401
C7 IP67, two levers	438
V-TYPE IP65/IP66, single lever	448 - 453
BIG hoods	468 - 469
T-TYPE IP65 insulating	482 - 483
T-TYPE / W IP66 insulating	490
HYGIENIC T-TYPE / H IP66/IP69	502
HYGIENIC T-TYPE / C IP66/IP69, -50 °C	507
W-TYPE for aggressive environments	522
E-Xtreme® corrosion proof	532 - 533, 543, 552 - 553
EMC	579
Central lever	606 - 608
LS-TYPE	620 - 621
IP68	636 - 639
panel supports:	page:
COB	652 - 653

inserts, crimp connections

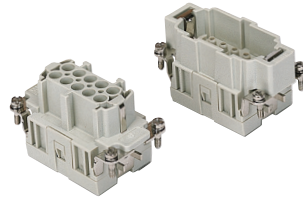

16A crimp contacts  
standard or for advanced opening  
silver and gold plated

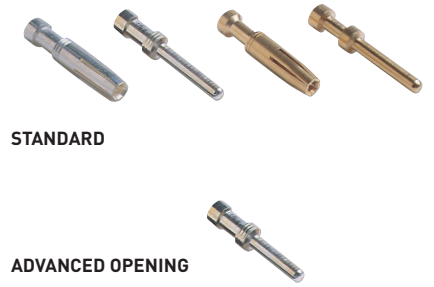

description	part No.	part No.
without contacts (to be ordered separately)		
female inserts for female contacts	<b>CCEF 10</b>	
male inserts for male contacts	<b>CCEM 10</b>	
16A female contacts		
0,14-0,37 mm <sup>2</sup> AWG 26-22 one groove		<b>CCFA 0.3</b>
0,5 mm <sup>2</sup> AWG 20 with no grooves		<b>CCFA 0.5</b>
0,75 mm <sup>2</sup> AWG 18 one groove (back side)		<b>CCFA 0.7</b>
1 mm <sup>2</sup> AWG 18 one groove		<b>CCFA 1.0</b>
1,5 mm <sup>2</sup> AWG 16 two grooves		<b>CCFA 1.5</b>
2,5 mm <sup>2</sup> AWG 14 three grooves		<b>CCFA 2.5</b>
3 mm <sup>2</sup> AWG 12 one wide groove		<b>CCFA 3.0</b>
4 mm <sup>2</sup> AWG 12 with no grooves		<b>CCFA 4.0</b>
16A male contacts		
0,14-0,37 mm <sup>2</sup> AWG 26-22 one groove		<b>CCMA 0.3</b>
0,5 mm <sup>2</sup> AWG 20 with no grooves		<b>CCMA 0.5</b>
0,75 mm <sup>2</sup> AWG 18 one groove (back side)		<b>CCMA 0.7</b>
1 mm <sup>2</sup> AWG 18 one groove		<b>CCMA 1.0</b>
1,5 mm <sup>2</sup> AWG 16t wo grooves		<b>CCMA 1.5</b>
2,5 mm <sup>2</sup> AWG 14 three grooves		<b>CCMA 2.5</b>
3 mm <sup>2</sup> AWG 12 one wide groove		<b>CCMA 3.0</b>
4 mm <sup>2</sup> AWG 12 with no grooves		<b>CCMA 4.0</b>
16A male crimp contacts for advanced opening		
0,5 mm <sup>2</sup> AWG 20 with no grooves		<b>CC 0.5 AN</b>
0,75 mm <sup>2</sup> AWG 18 one groove (back side)		<b>CC 0.7 AN</b>
1 mm <sup>2</sup> AWG 18 one groove		<b>CC 1.0 AN</b>
1,5 mm <sup>2</sup> AWG 16 two grooves		<b>CC 1.5 AN</b>
2,5 mm <sup>2</sup> AWG 14 three grooves		<b>CC 2.5 AN</b>
		<b>CCFD 0.3</b>
		<b>CCFD 0.5</b>
		<b>CCFD 0.7</b>
		<b>CCFD 1.0</b>
		<b>CCFD 1.5</b>
		<b>CCFD 2.5</b>
		<b>CCFD 3.0</b>
		<b>CCFD 4.0</b>
		<b>CCMD 0.3</b>
		<b>CCMD 0.5</b>
		<b>CCMD 0.7</b>
		<b>CCMD 1.0</b>
		<b>CCMD 1.5</b>
		<b>CCMD 2.5</b>
		<b>CCMD 3.0</b>
		<b>CCMD 4.0</b>

silver plated

gold plated+

\* for basic or high thickness gold plating, please refer to page 675

- characteristics according to EN 61984:
- 16A 500V 6kV 3**
- 16A 400/690V 6kV 2**
- certified
- rated voltage according to UL/CSA: 600V
- insulation resistance: ≥ 10 GΩ
- ambient temperature limit: -40 °C ... +125 °C
- made of self-extinguishing thermoplastic resin UL 94V-0
- mechanical life: ≥ 500 cycles
- contact resistance: ≤ 1 mΩ
- for max. current load see the connector inserts derating diagram below; for more information see page 28

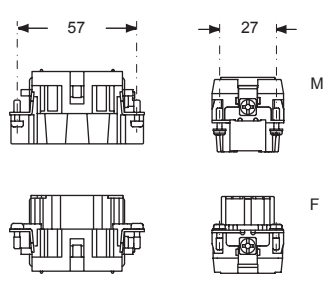
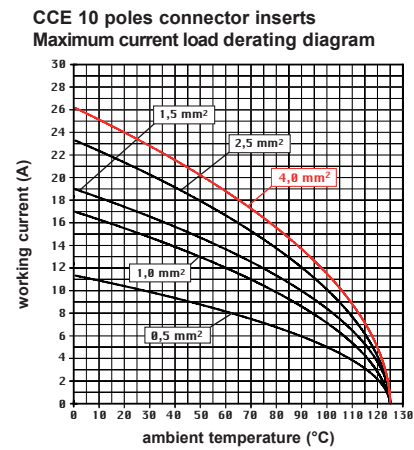

contacts side (front view)

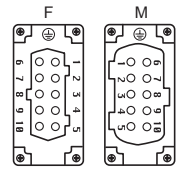

- it is recommended to crimp the contacts with crimping tools homologated by ILME (please see the crimping tool section 16A contacts, CCF, CCM and CC...AN series on pages 705 - 741)

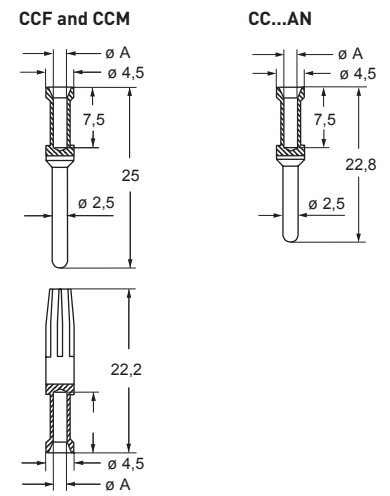

**CCF, CCM and CC...AN contacts**

conductor section mm <sup>2</sup>	conductor slot ø A (mm)	conductors stripping length (mm)
0,14-0,37	0,9	7,5
0,5	1,1	7,5
0,75	1,3	7,5
1,0	1,45	7,5
1,5	1,8	7,5
2,5	2,2	7,5
3	2,55	7,5
4	2,85	7,5

# CCE 16 poles + ⊕ 16A - 500V

enclosures: size "77.27"	page:
C-TYPE IP65/IP66	402 - 411
C7 IP67, two levers	439 - 440
V-TYPE IP65/IP66, single lever	454 - 458
BIG hoods	470 - 471
T-TYPE IP65 insulating	484 - 485
T-TYPE / W IP66 insulating	491
HYGIENIC T-TYPE / H IP66/IP69	503
HYGIENIC T-TYPE / C IP66/IP69, -50 °C	508
W-TYPE for aggressive environments	523
E-Xtreme® corrosion proof	534 - 535, 544, 554 - 555
EMC	580
Central lever	609 - 611
LS-TYPE	622 - 623
IP68	640 - 643
panel supports: COB	page: 652 - 653

inserts, crimp connections

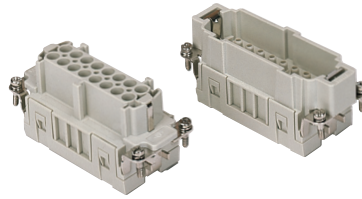

16A crimp contacts  
standard or for advanced opening  
silver and gold plated

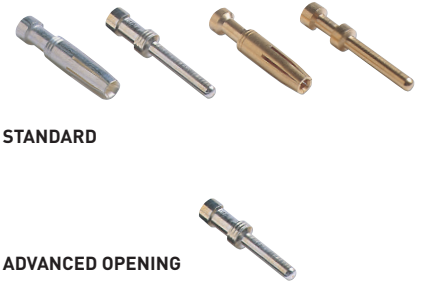

description	part No.	part No.
without contacts (to be ordered separately)		
female inserts for female contacts	<b>CCEF 16</b>	
male inserts for male contacts	<b>CCEM 16</b>	
16A female contacts		
0,14-0,37 mm <sup>2</sup> AWG 26-22 one groove		<b>CCFA 0.3</b>
0,5 mm <sup>2</sup> AWG 20 with no grooves		<b>CCFA 0.5</b>
0,75 mm <sup>2</sup> AWG 18 one groove (back side)		<b>CCFA 0.7</b>
1 mm <sup>2</sup> AWG 18 one groove		<b>CCFA 1.0</b>
1,5 mm <sup>2</sup> AWG 16 two grooves		<b>CCFA 1.5</b>
2,5 mm <sup>2</sup> AWG 14 three grooves		<b>CCFA 2.5</b>
3 mm <sup>2</sup> AWG 12 one wide groove		<b>CCFA 3.0</b>
4 mm <sup>2</sup> AWG 12 with no grooves		<b>CCFA 4.0</b>
		<b>silver plated</b>
		<b>CCFD 0.3</b>
		<b>CCFD 0.5</b>
		<b>CCFD 0.7</b>
		<b>CCFD 1.0</b>
		<b>CCFD 1.5</b>
		<b>CCFD 2.5</b>
		<b>CCFD 3.0</b>
		<b>CCFD 4.0</b>
		<b>gold plated+</b>
16A male contacts		
0,14-0,37 mm <sup>2</sup> AWG 26-22 one groove		<b>CCMA 0.3</b>
0,5 mm <sup>2</sup> AWG 20 with no grooves		<b>CCMA 0.5</b>
0,75 mm <sup>2</sup> AWG 18 one groove (back side)		<b>CCMA 0.7</b>
1 mm <sup>2</sup> AWG 18 one groove		<b>CCMA 1.0</b>
1,5 mm <sup>2</sup> AWG 16t wo grooves		<b>CCMA 1.5</b>
2,5 mm <sup>2</sup> AWG 14 three grooves		<b>CCMA 2.5</b>
3 mm <sup>2</sup> AWG 12 one wide groove		<b>CCMA 3.0</b>
4 mm <sup>2</sup> AWG 12 with no grooves		<b>CCMA 4.0</b>
16A male crimp contacts for advanced opening		
0,5 mm <sup>2</sup> AWG 20 with no grooves		<b>CC 0.5 AN</b>
0,75 mm <sup>2</sup> AWG 18 one groove (back side)		<b>CC 0.7 AN</b>
1 mm <sup>2</sup> AWG 18 one groove		<b>CC 1.0 AN</b>
1,5 mm <sup>2</sup> AWG 16 two grooves		<b>CC 1.5 AN</b>
2,5 mm <sup>2</sup> AWG 14 three grooves		<b>CC 2.5 AN</b>
		<b>CC 3.0 AN</b>
		<b>CC 4.0 AN</b>
		<b>CCMD 0.3</b>
		<b>CCMD 0.5</b>
		<b>CCMD 0.7</b>
		<b>CCMD 1.0</b>
		<b>CCMD 1.5</b>
		<b>CCMD 2.5</b>
		<b>CCMD 3.0</b>
		<b>CCMD 4.0</b>
		<sup>+</sup> for basic or high thickness gold plating, please refer to page 675

- characteristics according to EN 61984:
- 16A 500V 6kV 3**
- 16A 400/690V 6kV 2**
- certified
- rated voltage according to UL/CSA: 600V
- insulation resistance: ≥ 10 GΩ
- ambient temperature limit: -40 °C ... +125 °C
- made of self-extinguishing thermoplastic resin UL 94V-0
- mechanical life: ≥ 500 cycles
- contact resistance: ≤ 1 mΩ
- for max. current load see the connector inserts derating diagram below; for more information see page 28

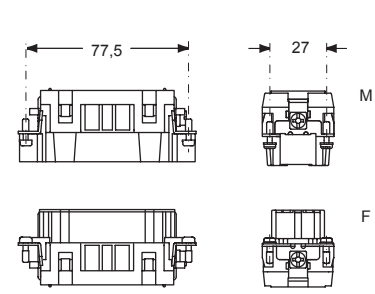
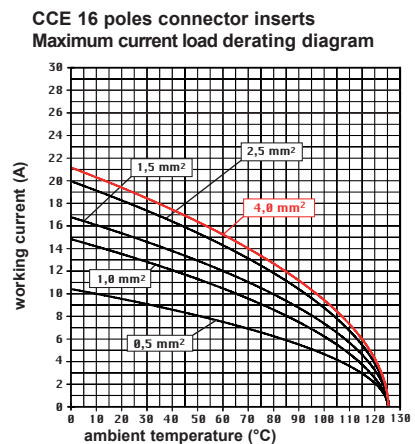

contacts side (front view)

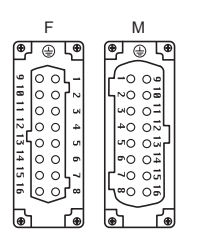

- it is recommended to crimp the contacts with crimping tools homologated by ILME (please see the crimping tool section 16A contacts, CCF, CCM and CC...AN series on pages 705 - 741)

CCF and CCM		CC...AN
CCF, CCM and CC...AN contacts		
conductor section mm <sup>2</sup>	conductor slot ø A (mm)	conductors stripping length (mm)
0,14-0,37	0,9	7,5
0,5	1,1	7,5
0,75	1,3	7,5
1,0	1,45	7,5
1,5	1,8	7,5
2,5	2,2	7,5
3	2,55	7,5
4	2,85	7,5

# CCE 24 poles + ⊕ 16A - 500V

enclosures: size "104.27"	page:
C-TYPE IP65/IP66	412 - 423
C7 IP67, two levers	441 - 442
V-TYPE IP65/IP66, single lever	459 - 463
BIG hoods	472 - 473
T-TYPE IP65 insulating	486 - 487
T-TYPE / W IP66 insulating	492
HYGIENIC T-TYPE / H IP66/IP69	504
HYGIENIC T-TYPE / C IP66/IP69, -50 °C	509
W-TYPE for aggressive environments	524
E-Xtreme® corrosion proof	536 - 537, 545, 556 - 557
EMC	581
Central lever	612 - 614
LS-TYPE	624 - 625
IP68	644 - 647
panel supports: COB	page: 652 - 653

## inserts, crimp connections

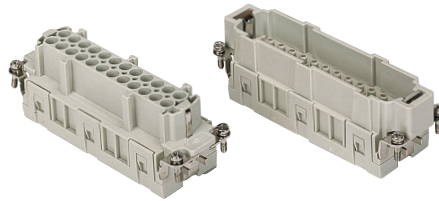

## 16A crimp contacts standard or for advanced opening silver and gold plated

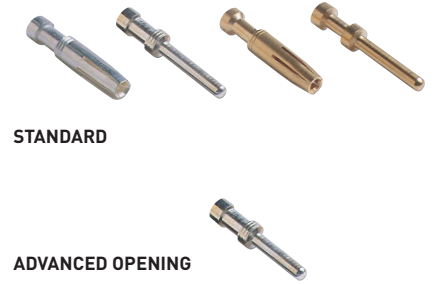

description	part No.	part No.
without contacts (to be ordered separately)	<b>CEEF 24</b>	
female inserts for female contacts	<b>CCEM 24</b>	
male inserts for male contacts		
16A female contacts		
0,14-0,37 mm <sup>2</sup> AWG 26-22 one groove	<b>CCFA 0.3</b>	<b>CCFD 0.3</b>
0,5 mm <sup>2</sup> AWG 20 with no grooves	<b>CCFA 0.5</b>	<b>CCFD 0.5</b>
0,75 mm <sup>2</sup> AWG 18 one groove (back side)	<b>CCFA 0.7</b>	<b>CCFD 0.7</b>
1 mm <sup>2</sup> AWG 18 one groove	<b>CCFA 1.0</b>	<b>CCFD 1.0</b>
1,5 mm <sup>2</sup> AWG 16 two grooves	<b>CCFA 1.5</b>	<b>CCFD 1.5</b>
2,5 mm <sup>2</sup> AWG 14 three grooves	<b>CCFA 2.5</b>	<b>CCFD 2.5</b>
3 mm <sup>2</sup> AWG 12 one wide groove	<b>CCFA 3.0</b>	<b>CCFD 3.0</b>
4 mm <sup>2</sup> AWG 12 with no grooves	<b>CCFA 4.0</b>	<b>CCFD 4.0</b>
16A male contacts		
0,14-0,37 mm <sup>2</sup> AWG 26-22 one groove	<b>CCMA 0.3</b>	<b>CCMD 0.3</b>
0,5 mm <sup>2</sup> AWG 20 with no grooves	<b>CCMA 0.5</b>	<b>CCMD 0.5</b>
0,75 mm <sup>2</sup> AWG 18 one groove (back side)	<b>CCMA 0.7</b>	<b>CCMD 0.7</b>
1 mm <sup>2</sup> AWG 18 one groove	<b>CCMA 1.0</b>	<b>CCMD 1.0</b>
1,5 mm <sup>2</sup> AWG 16t wo grooves	<b>CCMA 1.5</b>	<b>CCMD 1.5</b>
2,5 mm <sup>2</sup> AWG 14 three grooves	<b>CCMA 2.5</b>	<b>CCMD 2.5</b>
3 mm <sup>2</sup> AWG 12 one wide groove	<b>CCMA 3.0</b>	<b>CCMD 3.0</b>
4 mm <sup>2</sup> AWG 12 with no grooves	<b>CCMA 4.0</b>	<b>CCMD 4.0</b>
16A male crimp contacts for advanced opening		
0,5 mm <sup>2</sup> AWG 20 with no grooves	<b>CC 0.5 AN</b>	* for basic or high thickness gold plating, please refer to page 675
0,75 mm <sup>2</sup> AWG 18 one groove (back side)	<b>CC 0.7 AN</b>	
1 mm <sup>2</sup> AWG 18 one groove	<b>CC 1.0 AN</b>	
1,5 mm <sup>2</sup> AWG 16 two grooves	<b>CC 1.5 AN</b>	
2,5 mm <sup>2</sup> AWG 14 three grooves	<b>CC 2.5 AN</b>	

- characteristics according to EN 61984:
- 16A 500V 6kV 3**
- 16A 400/690V 6kV 2**
- certified
- rated voltage according to UL/CSA: 600V
- insulation resistance: ≥ 10 GΩ
- ambient temperature limit: -40 °C ... +125 °C
- made of self-extinguishing thermoplastic resin UL 94V-0
- mechanical life: ≥ 500 cycles
- contact resistance: ≤ 1 mΩ
- for max. current load see the connector inserts derating diagram below; for more information see page 28

**CCE 24 poles connector inserts  
Maximum current load derating diagram**

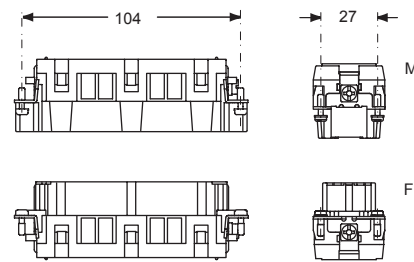
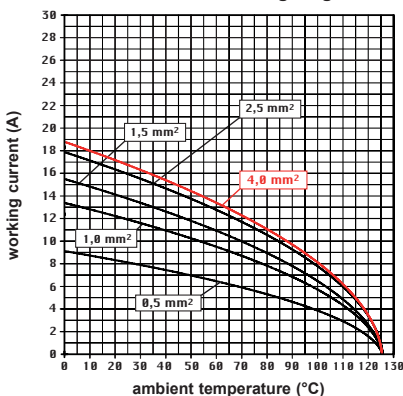

contacts side (front view)

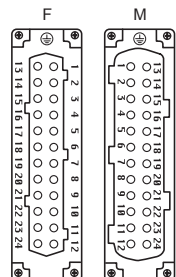

- it is recommended to crimp the contacts with crimping tools homologated by ILME (please see the crimping tool section 16A contacts, CCF, CCM and CC...AN series on pages 705 - 741)

### CCF and CCM

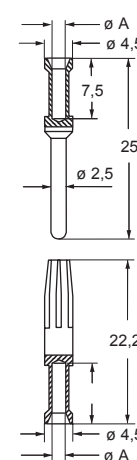

### CC...AN

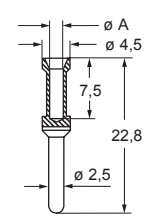

### CCF, CCM and CC...AN contacts

conductor section mm <sup>2</sup>	conductor slot ø A (mm)	conductors stripping length (mm)
0,14-0,37	0,9	7,5
0,5	1,1	7,5
0,75	1,3	7,5
1,0	1,45	7,5
1,5	1,8	7,5
2,5	2,2	7,5
3	2,55	7,5
4	2,85	7,5



# CCE 32 poles + ⊕ 16A - 500V

enclosures:  
size "77.62"

page:

C-TYPE IP65/IP66  
W-TYPE for aggressive environments  
E-Xtreme® corrosion proof

424 - 429  
525  
546

## inserts, crimp connections

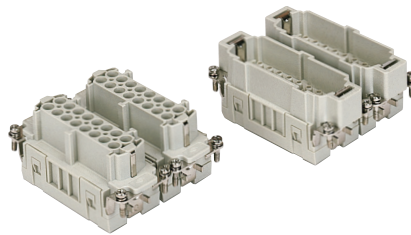

## 16A crimp contacts standard or for advanced opening silver and gold plated



STANDARD

ADVANCED OPENING

description	part No.	part No.	part No.
without contacts (to be ordered separately)			
female inserts for female contacts, No. (1-16) and (17-32)	<b>CCEF 16</b>	<b>CCEF 16 N</b>	
male inserts for male contacts, No. (1-16) and (17-32)	<b>CCEM 16</b>	<b>CCEM 16 N</b>	
<b>16A female contacts</b>			
0,14-0,37 mm <sup>2</sup> AWG 26-22 one groove			<b>CCFA 0.3</b>
0,5 mm <sup>2</sup> AWG 20 with no grooves			<b>CCFA 0.5</b>
0,75 mm <sup>2</sup> AWG 18 one groove (back side)			<b>CCFA 0.7</b>
1 mm <sup>2</sup> AWG 18 one groove			<b>CCFA 1.0</b>
1,5 mm <sup>2</sup> AWG 16 two grooves			<b>CCFA 1.5</b>
2,5 mm <sup>2</sup> AWG 14 three grooves			<b>CCFA 2.5</b>
3 mm <sup>2</sup> AWG 12 one wide groove			<b>CCFA 3.0</b>
4 mm <sup>2</sup> AWG 12 with no grooves			<b>CCFA 4.0</b>
<b>16A male contacts</b>			
0,14-0,37 mm <sup>2</sup> AWG 26-22 one groove			<b>CCMA 0.3</b>
0,5 mm <sup>2</sup> AWG 20 with no grooves			<b>CCMA 0.5</b>
0,75 mm <sup>2</sup> AWG 18 one groove (back side)			<b>CCMA 0.7</b>
1 mm <sup>2</sup> AWG 18 one groove			<b>CCMA 1.0</b>
1,5 mm <sup>2</sup> AWG 16t no grooves			<b>CCMA 1.5</b>
2,5 mm <sup>2</sup> AWG 14 three grooves			<b>CCMA 2.5</b>
3 mm <sup>2</sup> AWG 12 one wide groove			<b>CCMA 3.0</b>
4 mm <sup>2</sup> AWG 12 with no grooves			<b>CCMA 4.0</b>
<b>16A male crimp contacts for advanced opening</b>			
0,5 mm <sup>2</sup> AWG 20 with no grooves			<b>CC 0.5 AN</b>
0,75 mm <sup>2</sup> AWG 18 one groove (back side)			<b>CC 0.7 AN</b>
1 mm <sup>2</sup> AWG 18 one groove			<b>CC 1.0 AN</b>
1,5 mm <sup>2</sup> AWG 16 two grooves			<b>CC 1.5 AN</b>
2,5 mm <sup>2</sup> AWG 14 three grooves			<b>CC 2.5 AN</b>
			<b>CCFD 0.3</b>
			<b>CCFD 0.5</b>
			<b>CCFD 0.7</b>
			<b>CCFD 1.0</b>
			<b>CCFD 1.5</b>
			<b>CCFD 2.5</b>
			<b>CCFD 3.0</b>
			<b>CCFD 4.0</b>
			<b>CCMD 0.3</b>
			<b>CCMD 0.5</b>
			<b>CCMD 0.7</b>
			<b>CCMD 1.0</b>
			<b>CCMD 1.5</b>
			<b>CCMD 2.5</b>
			<b>CCMD 3.0</b>
			<b>CCMD 4.0</b>
			<b>CC 0.5 AN</b>
			<b>CC 0.7 AN</b>
			<b>CC 1.0 AN</b>
			<b>CC 1.5 AN</b>
			<b>CC 2.5 AN</b>

silver plated

gold plated+

\* for basic or high thickness gold plating, please refer to page 675

- characteristics according to EN 61984:

**16A 500V 6kV 3**  
**16A 400/690V 6kV 2**

- certified
- rated voltage according to UL/CSA: 600V
- insulation resistance: ≥ 10 GΩ
- ambient temperature limit: -40 °C ... +125 °C
- made of self-extinguishing thermoplastic resin UL 94V-0
- mechanical life: ≥ 500 cycles
- contact resistance: ≤ 1 mΩ
- for max. current load see the connector inserts derating diagram below; for more information see page 28

**CCE 32 poles connector inserts**  
**Maximum current load derating diagram**

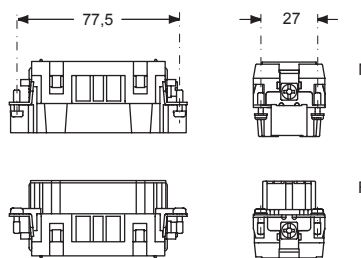
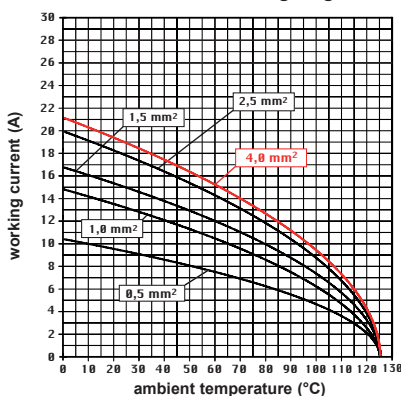

contacts side (front view)

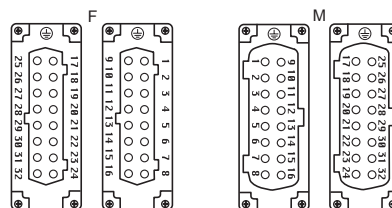

- it is recommended to crimp the contacts with crimping tools homologated by ILME (please see the crimping tool section 16A contacts, CCF, CCM and CC...AN series on pages 705 - 741)

### CCF and CCM

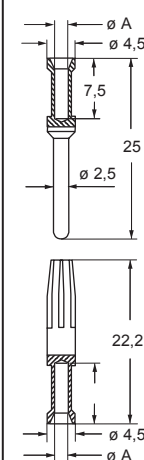

### CC...AN

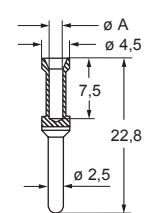

### CCF, CCM and CC...AN contacts

conductor section mm <sup>2</sup>	conductor slot ø A (mm)	conductors stripping length (mm)
0,14-0,37	0,9	7,5
0,5	1,1	7,5
0,75	1,3	7,5
1,0	1,45	7,5
1,5	1,8	7,5
2,5	2,2	7,5
3	2,55	7,5
4	2,85	7,5



# CCE 48 poles + ⊕ 16A - 500V

enclosures:  
size "104.62"

page:

C-TYPE IP65/IP66  
W-TYPE for aggressive environments  
E-Xtreme® corrosion proof

430  
526  
547

## inserts, crimp connections

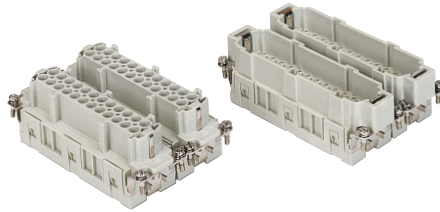

## 16A crimp contacts standard or for advanced opening silver and gold plated

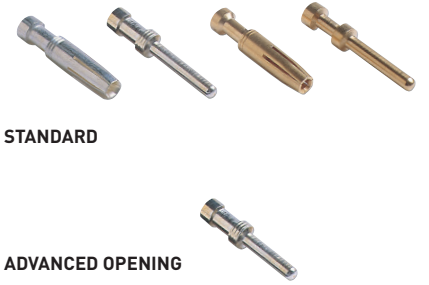

STANDARD

ADVANCED OPENING

description	part No.	part No.	part No.
without contacts (to be ordered separately)			
female inserts for female contacts, No. (1-24) and (25-48)	<b>CCEF 24</b>	<b>CCEF 24 N</b>	
male inserts for male contacts, No. (1-24) and (25-48)	<b>CCEM 24</b>	<b>CCEM 24 N</b>	
<b>16A female contacts</b>			
0,14-0,37 mm <sup>2</sup> AWG 26-22 one groove			<b>CCFA 0.3</b>
0,5 mm <sup>2</sup> AWG 20 with no grooves			<b>CCFA 0.5</b>
0,75 mm <sup>2</sup> AWG 18 one groove (back side)			<b>CCFA 0.7</b>
1 mm <sup>2</sup> AWG 18 one groove			<b>CCFA 1.0</b>
1,5 mm <sup>2</sup> AWG 16 two grooves			<b>CCFA 1.5</b>
2,5 mm <sup>2</sup> AWG 14 three grooves			<b>CCFA 2.5</b>
3 mm <sup>2</sup> AWG 12 one wide groove			<b>CCFA 3.0</b>
4 mm <sup>2</sup> AWG 12 with no grooves			<b>CCFA 4.0</b>
<b>16A male contacts</b>			
0,14-0,37 mm <sup>2</sup> AWG 26-22 one groove			<b>CCMA 0.3</b>
0,5 mm <sup>2</sup> AWG 20 with no grooves			<b>CCMA 0.5</b>
0,75 mm <sup>2</sup> AWG 18 one groove (back side)			<b>CCMA 0.7</b>
1 mm <sup>2</sup> AWG 18 one groove			<b>CCMA 1.0</b>
1,5 mm <sup>2</sup> AWG 16t wo grooves			<b>CCMA 1.5</b>
2,5 mm <sup>2</sup> AWG 14 three grooves			<b>CCMA 2.5</b>
3 mm <sup>2</sup> AWG 12 one wide groove			<b>CCMA 3.0</b>
4 mm <sup>2</sup> AWG 12 with no grooves			<b>CCMA 4.0</b>
<b>16A male crimp contacts for advanced opening</b>			
0,5 mm <sup>2</sup> AWG 20 with no grooves			<b>CC 0.5 AN</b>
0,75 mm <sup>2</sup> AWG 18 one groove (back side)			<b>CC 0.7 AN</b>
1 mm <sup>2</sup> AWG 18 one groove			<b>CC 1.0 AN</b>
1,5 mm <sup>2</sup> AWG 16 two grooves			<b>CC 1.5 AN</b>
2,5 mm <sup>2</sup> AWG 14 three grooves			<b>CC 2.5 AN</b>

silver plated

gold plated+

\* for basic or high thickness gold plating, please refer to page 675

- characteristics according to EN 61984:
- 16A 500V 6kV 3**
- 16A 400/690V 6kV 2**
- certified
- rated voltage according to UL/CSA: 600V
- insulation resistance: ≥ 10 GΩ
- ambient temperature limit: -40 °C ... +125 °C
- made of self-extinguishing thermoplastic resin UL 94V-0
- mechanical life: ≥ 500 cycles
- contact resistance: ≤ 1 mΩ
- for max. current load see the connector inserts derating diagram below; for more information see page 28

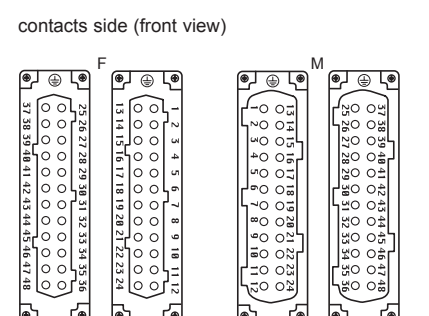
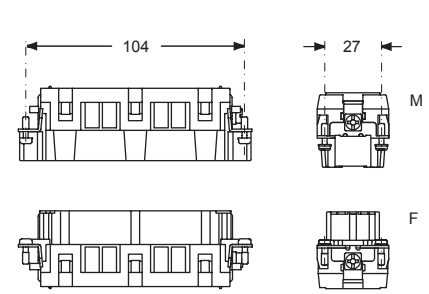

**CCE 48 poles connector inserts**  
Maximum current load derating diagram

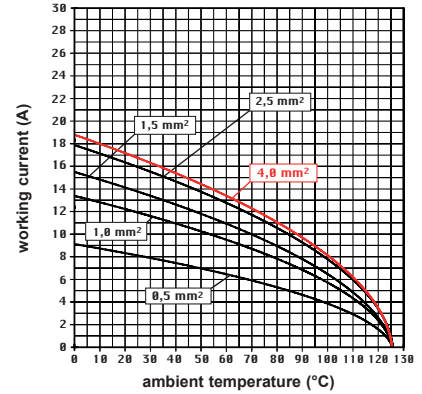

- it is recommended to crimp the contacts with crimping tools homologated by ILME (please see the crimping tool section 16A contacts, CCF, CCM and CC...AN series on pages 705 - 741)

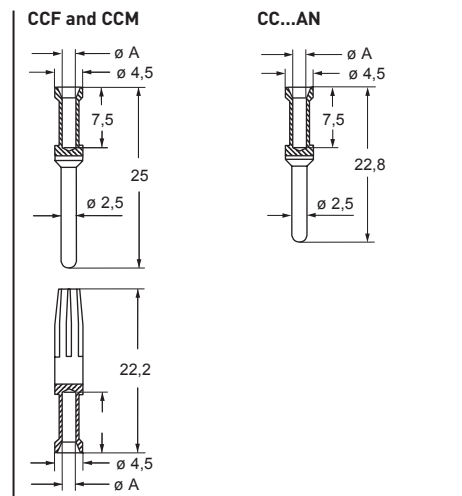

CCF, CCM and CC...AN contacts		
conductor section mm <sup>2</sup>	conductor slot ø A (mm)	conductors stripping length (mm)
0,14-0,37	0,9	7,5
0,5	1,1	7,5
0,75	1,3	7,5
1,0	1,45	7,5
1,5	1,8	7,5
2,5	2,2	7,5
3	2,55	7,5
4	2,85	7,5

CCE

# CM SH-SQUICH® 3 + 2 (aux) poles + ⊕ 16A - 830V

enclosures: size "57.27"	page:
C-TYPE IP65/IP66	393 - 401
C7 IP67, two levers	438
V-TYPE IP65/IP66, single lever	448 - 453
BIG hoods	468 - 469
T-TYPE IP65 insulating	482 - 483
T-TYPE / W IP66 insulating	490
HYGIENIC T-TYPE / H IP66/IP69	502
HYGIENIC T-TYPE / C IP66/IP69, -50 °C	507
W-TYPE for aggressive environments	522
E-Extreme® corrosion proof	532 - 533, 543, 552 - 553
EMC	579
Central lever	606 - 608
LS-TYPE	620 - 621
IP68	636 - 639
panel supports: COB	page: 652 - 653

inserts,  
spring terminal connection without tools

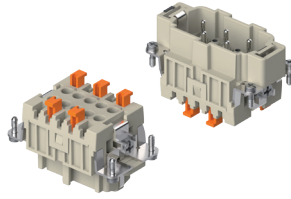

Q SILVER PLATED CONTACTS

description	part No.
-------------	----------

spring terminals with actuator button  
female inserts with female contacts  
male inserts with male contacts

CMSHF 03  
CMSHM 03

- characteristics according to EN 61984:  
**16A 830V 8kV 3**  
**16A 1000V 8kV 2**  
**16A 720/1250V 8kV 2**
- auxiliary contacts: **16A 500V 6kV 3**
- certified
- rated voltage according to UL/CSA: 600V
- insulation resistance: ≥ 10 GΩ
- ambient temperature limit: -40 °C ... +125 °C
- made of self-extinguishing thermoplastic resin UL 94V-0
- mechanical life: ≥ 500 cycles
- contact resistance: ≤ 3 mΩ
- for max. current load see the connector inserts derating diagram below; for more information see page 28

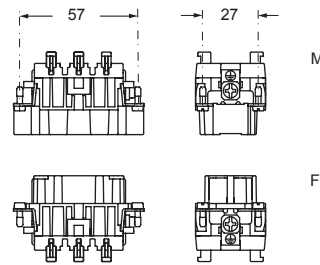

contacts side (front view)

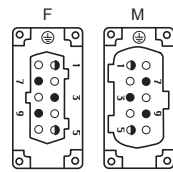

● the auxiliary contacts are in the forward position upon opening

- inserts for section conductors:  
0,14 - 2,5 mm<sup>2</sup> - AWG 26 - 14
- conductors stripping length: 9...11 mm

CM SH 03 poles connector inserts  
Maximum current load derating diagram

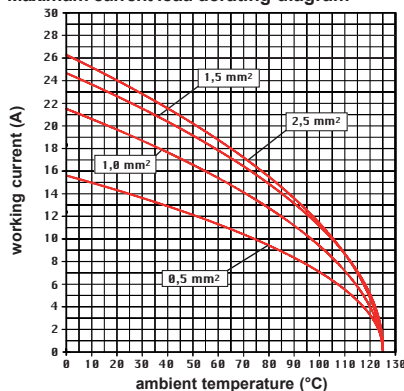

### SQUICH®-spring connection technology

#### WIRING

- Deeply insert a stripped conductor into a round terminal.
- Push the actuator button to close the terminal.

#### RE-OPENING

- Insert a **0,5 x 3,5 mm** flat blade screwdriver in the actuator button side window and pull it up by levering down.

# CMCE 3 + 2 (aux) poles + ⊕ 16A - 830V

enclosures: size "57.27"	page:
C-TYPE IP65/IP66	393 - 401
C7 IP67, two levers	438
V-TYPE IP65/IP66, single lever	448 - 453
BIG hoods	468 - 469
T-TYPE IP65 insulating	482 - 483
T-TYPE / W IP66 insulating	490
HYGIENIC T-TYPE / H IP66/IP69	502
HYGIENIC T-TYPE / C IP66/IP69, -50 °C	507
W-TYPE for aggressive environments	522
E-Xtreme® corrosion proof	532 - 533, 543, 552 - 553
EMC	579
Central lever	606 - 608
LS-TYPE	620 - 621
IP68	636 - 639
panel supports: COB	page: 652 - 653

## inserts, crimp connections

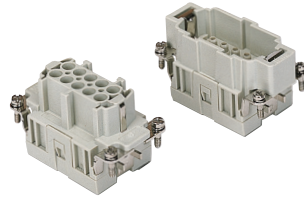

## 16A crimp contacts standard or for advanced opening silver and gold plated

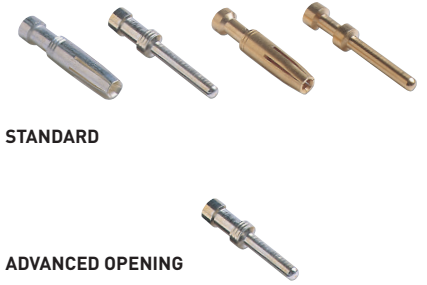

description	part No.	part No.
without contacts (to be ordered separately)		
female inserts for female contacts	<b>CMCE03</b>	
male inserts for male contacts	<b>CMCEM03</b>	
<b>16A female contacts</b>		
0,14-0,37 mm <sup>2</sup> AWG 26-22 one groove	<b>CCFA 0.3</b>	<b>CCFD 0.3</b>
0,5 mm <sup>2</sup> AWG 20 with no grooves	<b>CCFA 0.5</b>	<b>CCFD 0.5</b>
0,75 mm <sup>2</sup> AWG 18 one groove (back side)	<b>CCFA 0.7</b>	<b>CCFD 0.7</b>
1 mm <sup>2</sup> AWG 18 one groove	<b>CCFA 1.0</b>	<b>CCFD 1.0</b>
1,5 mm <sup>2</sup> AWG 16 two grooves	<b>CCFA 1.5</b>	<b>CCFD 1.5</b>
2,5 mm <sup>2</sup> AWG 14 three grooves	<b>CCFA 2.5</b>	<b>CCFD 2.5</b>
3 mm <sup>2</sup> AWG 12 one wide groove	<b>CCFA 3.0</b>	<b>CCFD 3.0</b>
4 mm <sup>2</sup> AWG 12 with no grooves	<b>CCFA 4.0</b>	<b>CCFD 4.0</b>
<b>16A male contacts</b>		
0,14-0,37 mm <sup>2</sup> AWG 26-22 one groove	<b>CCMA 0.3</b>	<b>CCMD 0.3</b>
0,5 mm <sup>2</sup> AWG 20 with no grooves	<b>CCMA 0.5</b>	<b>CCMD 0.5</b>
0,75 mm <sup>2</sup> AWG 18 one groove (back side)	<b>CCMA 0.7</b>	<b>CCMD 0.7</b>
1 mm <sup>2</sup> AWG 18 one groove	<b>CCMA 1.0</b>	<b>CCMD 1.0</b>
1,5 mm <sup>2</sup> AWG 16t wo grooves	<b>CCMA 1.5</b>	<b>CCMD 1.5</b>
2,5 mm <sup>2</sup> AWG 14 three grooves	<b>CCMA 2.5</b>	<b>CCMD 2.5</b>
3 mm <sup>2</sup> AWG 12 one wide groove	<b>CCMA 3.0</b>	<b>CCMD 3.0</b>
4 mm <sup>2</sup> AWG 12 with no grooves	<b>CCMA 4.0</b>	<b>CCMD 4.0</b>
<b>16A male crimp contacts for advanced opening</b>		
0,5 mm <sup>2</sup> AWG 20 with no grooves	<b>CC 0.5 AN</b>	* for basic or high thickness gold plating, please refer to page 675
0,75 mm <sup>2</sup> AWG 18 one groove (back side)	<b>CC 0.7 AN</b>	
1 mm <sup>2</sup> AWG 18 one groove	<b>CC 1.0 AN</b>	
1,5 mm <sup>2</sup> AWG 16 two grooves	<b>CC 1.5 AN</b>	
2,5 mm <sup>2</sup> AWG 14 three grooves	<b>CC 2.5 AN</b>	

- characteristics according to EN 61984:  
**16A 830V 8kV 3**  
**16A 1000V 8kV 2**  
**16A 720/1250V 8kV 2**
- auxiliary contacts: **16A 500V 6kV 3**
- certified
- rated voltage according to UL/CSA: 600V
- insulation resistance: ≥ 10 GΩ
- ambient temperature limit: -40 °C ... +125 °C
- made of self-extinguishing thermoplastic resin UL 94V-0
- mechanical life: ≥ 500 cycles
- contact resistance: ≤ 1 mΩ
- for max. current load see the connector inserts derating diagram below; for more information see page 28

### CMCE 03 poles connector inserts Maximum current load derating diagram

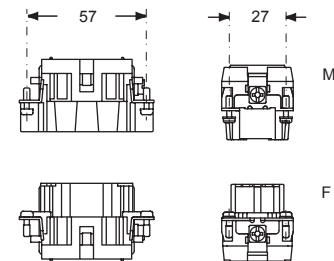
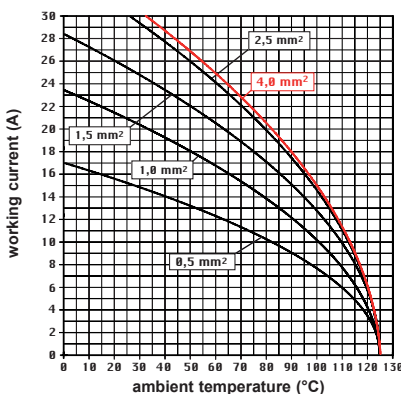

contacts side (front view)

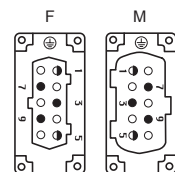

the auxiliary contacts are in the forward position upon opening

- it is recommended to crimp the contacts with crimping tools homologated by ILME (please see the crimping tool section 16A contacts, CCF, CCM and CC...AN series on pages 705 - 741)

### CCF and CCM

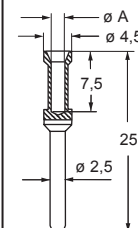

### CC...AN

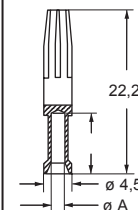
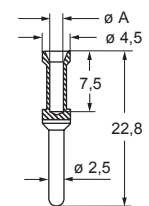

### CCF, CCM and CC...AN contacts

conductor section mm <sup>2</sup>	conductor slot Ø A (mm)	conductors stripping length (mm)
0,14-0,37	0,9	7,5
0,5	1,1	7,5
0,75	1,3	7,5
1,0	1,45	7,5
1,5	1,8	7,5
2,5	2,2	7,5
3	2,55	7,5
4	2,85	7,5

# CMSH-SQUICH® 6 + 2 (aux) poles + ⊕ 16A - 830V

enclosures: size "77.27"	page:
C-TYPE IP65/IP66	402 - 411
C7 IP67, two levers	439 - 440
V-TYPE IP65/IP66, single lever	454 - 458
BIG hoods	470 - 471
T-TYPE IP65 insulating	484 - 485
T-TYPE / W IP66 insulating	491
HYGIENIC T-TYPE / H IP66/IP69	503
HYGIENIC T-TYPE / C IP66/IP69, -50 °C	508
W-TYPE for aggressive environments	523
E-Xtreme® corrosion proof	534 - 535, 544, 554 - 555
EMC	580
Central lever	609 - 611
LS-TYPE	622 - 623
IP68	640 - 643
panel supports: COB	page: 652 - 653

inserts,  
spring terminal connection without tools

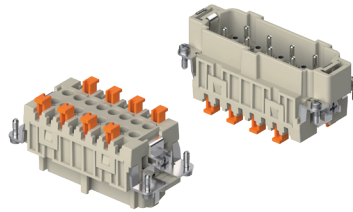

## Q SILVER PLATED CONTACTS

description	part No.
-------------	----------

spring terminals with actuator button  
female inserts with female contacts  
male inserts with male contacts

CMSHF 06  
CMSHM 06

- characteristics according to EN 61984:

- 16A 830V 8kV 3**
- 16A 1000V 8kV 2**
- 16A 720/1250V 8kV 2**
- auxiliary contacts: **16A 500V 6kV 3**

- certified by (UL for USA and Canada),

- rated voltage according to UL/CSA: 600V
- insulation resistance:  $\geq 10 \text{ G}\Omega$
- ambient temperature limit:  $-40 \text{ }^\circ\text{C} \dots +125 \text{ }^\circ\text{C}$
- made of self-extinguishing thermoplastic resin UL 94V-0
- mechanical life:  $\geq 500$  cycles
- contact resistance:  $\leq 3 \text{ m}\Omega$
- for max. current load see the connector inserts derating diagram below; for more information see page 28

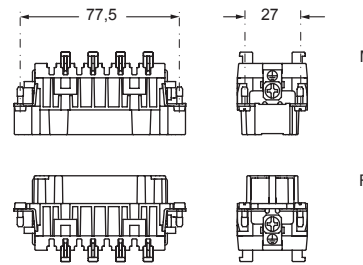

contacts side (front view)

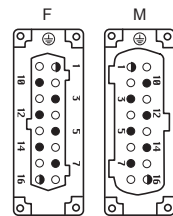

● the auxiliary contacts are in the forward position upon opening

- inserts for section conductors: 0,14 - 2,5 mm<sup>2</sup> - AWG 26 - 14
- conductors stripping length: 9...11 mm

CMSH 06 poles connector inserts  
Maximum current load derating diagram

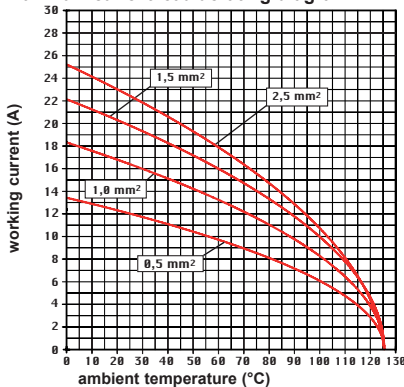

### SQUICH®-spring connection technology

#### WIRING

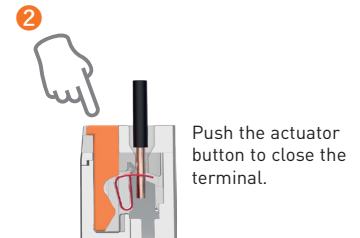
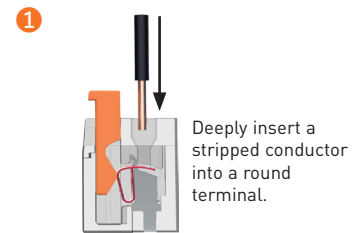

#### RE-OPENING

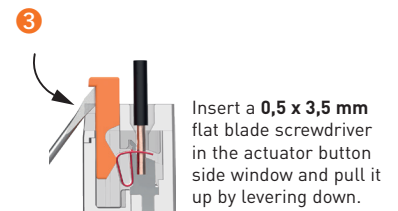

CMSH-SQUICH® 830V

# CMCE 6 + 2 (aux) poles + ⊕ 16A - 830V

enclosures: size "77.27"	page:
C-TYPE IP65/IP66	402 - 411
C7 IP67, two levers	439 - 440
V-TYPE IP65/IP66, single lever	454 - 458
BIG hoods	470 - 471
T-TYPE IP65 insulating	484 - 485
T-TYPE / W IP66 insulating	491
HYGIENIC T-TYPE / H IP66/IP69	503
HYGIENIC T-TYPE / C IP66/IP69, -50 °C	508
W-TYPE for aggressive environments	523
E-Xtreme® corrosion proof	534 - 535, 544, 554 - 555
EMC	580
Central lever	609 - 611
LS-TYPE	622 - 623
IP68	640 - 643
panel supports:	page:
COB	652 - 653

inserts, crimp connections

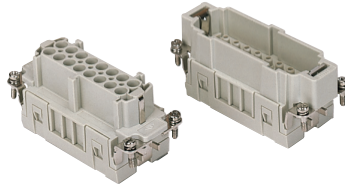

16A crimp contacts  
standard or for advanced opening  
silver and gold plated

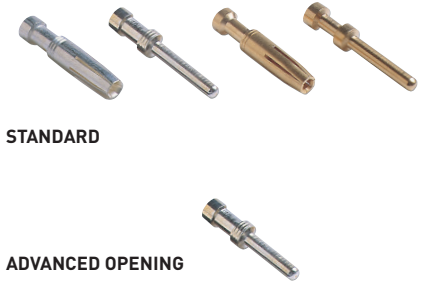

description	part No.	part No.
without contacts (to be ordered separately)		
female inserts for female contacts	<b>CMCE06</b>	
male inserts for male contacts	<b>CMCEM06</b>	
16A female contacts		
0,14-0,37 mm <sup>2</sup> AWG 26-22 one groove		<b>CCFA 0.3</b>
0,5 mm <sup>2</sup> AWG 20 with no grooves		<b>CCFA 0.5</b>
0,75 mm <sup>2</sup> AWG 18 one groove (back side)		<b>CCFA 0.7</b>
1 mm <sup>2</sup> AWG 18 one groove		<b>CCFA 1.0</b>
1,5 mm <sup>2</sup> AWG 16 two grooves		<b>CCFA 1.5</b>
2,5 mm <sup>2</sup> AWG 14 three grooves		<b>CCFA 2.5</b>
3 mm <sup>2</sup> AWG 12 one wide groove		<b>CCFA 3.0</b>
4 mm <sup>2</sup> AWG 12 with no grooves		<b>CCFA 4.0</b>
16A male contacts		
0,14-0,37 mm <sup>2</sup> AWG 26-22 one groove		<b>CCMA 0.3</b>
0,5 mm <sup>2</sup> AWG 20 with no grooves		<b>CCMA 0.5</b>
0,75 mm <sup>2</sup> AWG 18 one groove (back side)		<b>CCMA 0.7</b>
1 mm <sup>2</sup> AWG 18 one groove		<b>CCMA 1.0</b>
1,5 mm <sup>2</sup> AWG 16t wo grooves		<b>CCMA 1.5</b>
2,5 mm <sup>2</sup> AWG 14 three grooves		<b>CCMA 2.5</b>
3 mm <sup>2</sup> AWG 12 one wide groove		<b>CCMA 3.0</b>
4 mm <sup>2</sup> AWG 12 with no grooves		<b>CCMA 4.0</b>
16A male crimp contacts for advanced opening		
0,5 mm <sup>2</sup> AWG 20 with no grooves		<b>CC 0.5 AN</b>
0,75 mm <sup>2</sup> AWG 18 one groove (back side)		<b>CC 0.7 AN</b>
1 mm <sup>2</sup> AWG 18 one groove		<b>CC 1.0 AN</b>
1,5 mm <sup>2</sup> AWG 16 two grooves		<b>CC 1.5 AN</b>
2,5 mm <sup>2</sup> AWG 14 three grooves		<b>CC 2.5 AN</b>

silver plated	<b>CCFD 0.3</b>	gold plated
	<b>CCFD 0.5</b>	
	<b>CCFD 0.7</b>	
	<b>CCFD 1.0</b>	
	<b>CCFD 1.5</b>	
	<b>CCFD 2.5</b>	
	<b>CCFD 3.0</b>	
	<b>CCFD 4.0</b>	
	<b>CCMD 0.3</b>	
	<b>CCMD 0.5</b>	
	<b>CCMD 0.7</b>	
	<b>CCMD 1.0</b>	
	<b>CCMD 1.5</b>	
	<b>CCMD 2.5</b>	
<b>CCMD 3.0</b>		
<b>CCMD 4.0</b>		

\* for basic or high thickness gold plating, please refer to page 675

- characteristics according to EN 61984:  
**16A 830V 8kV 3**  
**16A 1000V 8kV 2**  
**16A 720/1250V 8kV 2**
- auxiliary contacts: **16A 500V 6kV 3**
- certified
- rated voltage according to UL/CSA: 600V
- insulation resistance: ≥ 10 GΩ
- ambient temperature limit: -40 °C ... +125 °C
- made of self-extinguishing thermoplastic resin UL 94V-0
- mechanical life: ≥ 500 cycles
- contact resistance: ≤ 1 mΩ
- for max. current load see the connector inserts derating diagram below; for more information see page 28

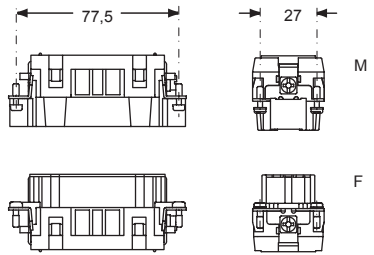

contacts side (front view)

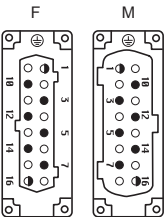

the auxiliary contacts are in the forward position upon opening

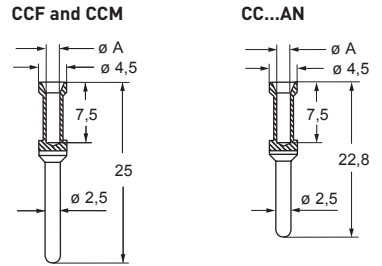

**CCF, CCM and CC...AN contacts**

conductor section mm <sup>2</sup>	conductor slot ø A (mm)	conductors stripping length (mm)
0,14-0,37	0,9	7,5
0,5	1,1	7,5
0,75	1,3	7,5
1,0	1,45	7,5
1,5	1,8	7,5
2,5	2,2	7,5
3	2,55	7,5
4	2,85	7,5

**CMCE 06 poles connector inserts**  
**Maximum current load derating diagram**

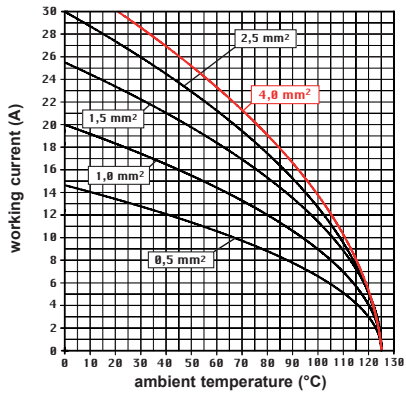

- it is recommended to crimp the contacts with crimping tools homologated by ILME (please see the crimping tool section 16A contacts, CCF, CCM and CC...AN series on pages 705 - 741)



# CMSH-SQUICH® 10 + 2 (aux) poles + ⊕ 16A - 830V

enclosures: size "104.27"	page:
C-TYPE IP65/IP66	412 - 423
C7 IP67, two levers	441 - 442
V-TYPE IP65/IP66, single lever	459 - 463
BIG hoods	472 - 473
T-TYPE IP65 insulating	486 - 487
T-TYPE / W IP66 insulating	492
HYGIENIC T-TYPE / H IP66/IP69	504
HYGIENIC T-TYPE / C IP66/IP69, -50 °C	509
W-TYPE for aggressive environments	524
E-Xtreme® corrosion proof	536 - 537, 545, 556 - 557
EMC	581
Central lever	612 - 614
LS-TYPE	624 - 625
IP68	644 - 647

panel supports: COB	page: 652 - 653
------------------------	--------------------

inserts,  
spring terminal connection without tools

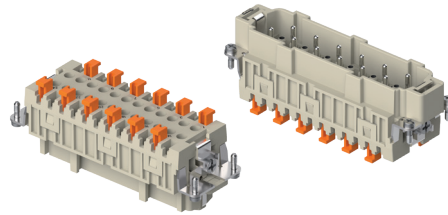

**Q SILVER PLATED CONTACTS**

description	part No.
-------------	----------

spring terminals with actuator button  
female inserts with female contacts  
male inserts with male contacts

**CMSHF 10**  
**CMSHM 10**

- characteristics according to EN 61984:

- 16A 830V 8kV 3**
- 16A 1000V 8kV 2**
- 16A 720/1250V 8kV 2**

- auxiliary contacts: **16A 500V 6kV 3**  
- certified

- rated voltage according to UL/CSA: 600V
- insulation resistance:  $\geq 10 \text{ G}\Omega$
- ambient temperature limit:  $-40 \text{ }^\circ\text{C} \dots +125 \text{ }^\circ\text{C}$
- made of self-extinguishing thermoplastic resin UL 94V-0
- mechanical life:  $\geq 500$  cycles
- contact resistance:  $\leq 3 \text{ m}\Omega$
- for max. current load see the connector inserts derating diagram below; for more information see page 28

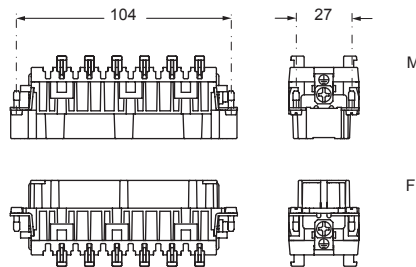

contacts side (front view)

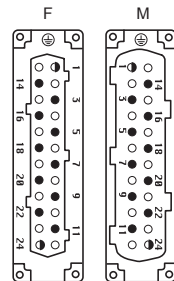

● the auxiliary contacts are in the forward position upon opening

- inserts for section conductors: 0,14 - 2,5 mm<sup>2</sup> - AWG 26 - 14
- conductors stripping length: 9...11 mm

**CMSH 10 poles connector inserts**  
Maximum current load derating diagram

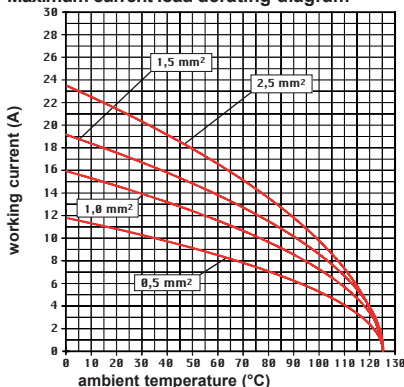

**SQUICH®-spring connection technology**

**WIRING**

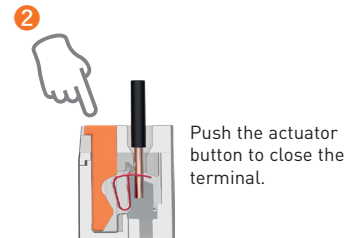
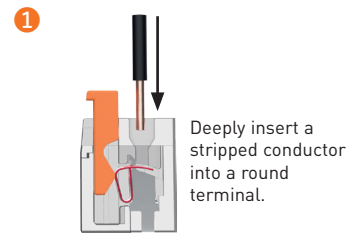

**RE-OPENING**

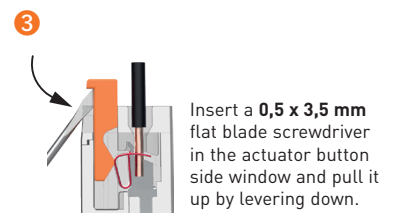

CMSH-SQUICH® 830V



# CMCE 10 + 2 (aux) poles + ⊕ 16A - 830V

enclosures: size "104.27"	page:
C-TYPE IP65/IP66	412 - 423
C7 IP67, two levers	441 - 442
V-TYPE IP65/IP66, single lever	459 - 463
BIG hoods	472 - 473
T-TYPE IP65 insulating	486 - 487
T-TYPE / W IP66 insulating	492
HYGIENIC T-TYPE / H IP66/IP69	504
HYGIENIC T-TYPE / C IP66/IP69, -50 °C	509
W-TYPE for aggressive environments	524
E-Xtreme® corrosion proof	536 - 537, 545, 556 - 557
EMC	581
Central lever	612 - 614
LS-TYPE	624 - 625
IP68	644 - 647
panel supports: COB	page: 652 - 653

inserts, crimp connections

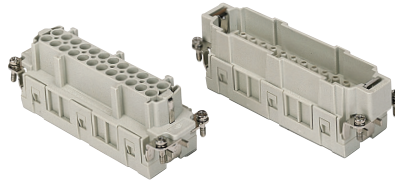

16A crimp contacts  
standard or for advanced opening  
silver and gold plated

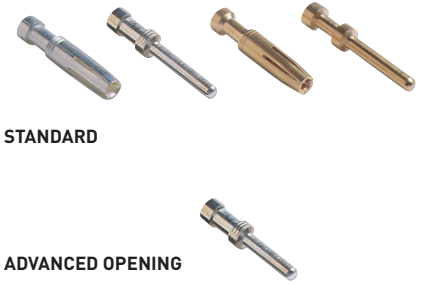

description	part No.	part No.
without contacts (to be ordered separately)	<b>CMCEF 10</b>	
female inserts for female contacts	<b>CMCEM 10</b>	
male inserts for male contacts		
16A female contacts		
0,14-0,37 mm <sup>2</sup> AWG 26-22 one groove		<b>CCFA 0.3</b>
0,5 mm <sup>2</sup> AWG 20 with no grooves		<b>CCFA 0.5</b>
0,75 mm <sup>2</sup> AWG 18 one groove (back side)		<b>CCFA 0.7</b>
1 mm <sup>2</sup> AWG 18 one groove		<b>CCFA 1.0</b>
1,5 mm <sup>2</sup> AWG 16 two grooves		<b>CCFA 1.5</b>
2,5 mm <sup>2</sup> AWG 14 three grooves		<b>CCFA 2.5</b>
3 mm <sup>2</sup> AWG 12 one wide groove		<b>CCFA 3.0</b>
4 mm <sup>2</sup> AWG 12 with no grooves		<b>CCFA 4.0</b>
16A male contacts		
0,14-0,37 mm <sup>2</sup> AWG 26-22 one groove		<b>CCMA 0.3</b>
0,5 mm <sup>2</sup> AWG 20 with no grooves		<b>CCMA 0.5</b>
0,75 mm <sup>2</sup> AWG 18 one groove (back side)		<b>CCMA 0.7</b>
1 mm <sup>2</sup> AWG 18 one groove		<b>CCMA 1.0</b>
1,5 mm <sup>2</sup> AWG 16t wo grooves		<b>CCMA 1.5</b>
2,5 mm <sup>2</sup> AWG 14 three grooves		<b>CCMA 2.5</b>
3 mm <sup>2</sup> AWG 12 one wide groove		<b>CCMA 3.0</b>
4 mm <sup>2</sup> AWG 12 with no grooves		<b>CCMA 4.0</b>
16A male crimp contacts for advanced opening		
0,5 mm <sup>2</sup> AWG 20 with no grooves		<b>CC 0.5 AN</b>
0,75 mm <sup>2</sup> AWG 18 one groove (back side)		<b>CC 0.7 AN</b>
1 mm <sup>2</sup> AWG 18 one groove		<b>CC 1.0 AN</b>
1,5 mm <sup>2</sup> AWG 16 two grooves		<b>CC 1.5 AN</b>
2,5 mm <sup>2</sup> AWG 14 three grooves		<b>CC 2.5 AN</b>

silver plated

gold plated\*

\* for basic or high thickness gold plating, please refer to page 675

- characteristics according to EN 61984:  
**16A 830V 8kV 3**  
**16A 1000V 8kV 2**  
**16A 720/1250V 8kV 2**
- auxiliary contacts: **16A 500V 6kV 3**
- certified
- rated voltage according to UL/CSA: 600V
- insulation resistance: ≥ 10 GΩ
- ambient temperature limit: -40 °C ... +125 °C
- made of self-extinguishing thermoplastic resin UL 94V-0
- mechanical life: ≥ 500 cycles
- contact resistance: ≤ 1 mΩ
- for max. current load see the connector inserts derating diagram below; for more information see page 28

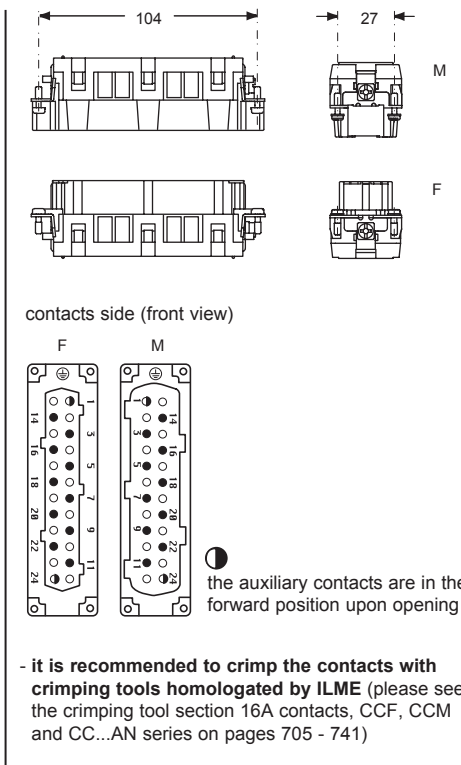
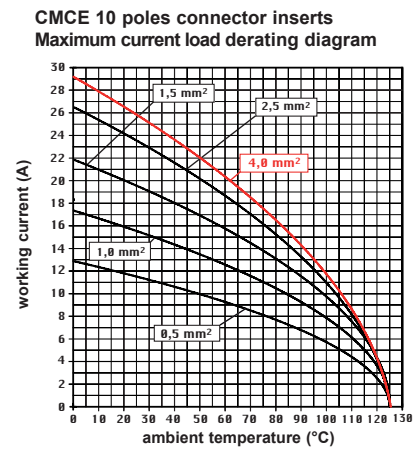

CCF and CCM		CC...AN
conductor section mm <sup>2</sup>	conductor slot ø A (mm)	conductors stripping length (mm)
0,14-0,37	0,9	7,5
0,5	1,1	7,5
0,75	1,3	7,5
1,0	1,45	7,5
1,5	1,8	7,5
2,5	2,2	7,5
3	2,55	7,5
4	2,85	7,5

CMCE 830V

# CMSH-SQUICH® 12 + 4 (aux) poles + ⊕ 16A - 830V

enclosures:  
size "77.62"

page:

C-TYPE IP65/IP66  
W-TYPE for aggressive environments  
E-Xtreme® corrosion proof

424 - 429  
525  
546

inserts,  
spring terminal connection without tools

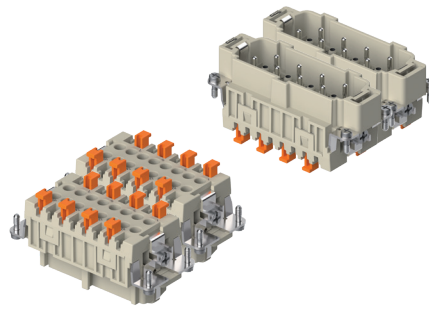

**Q SILVER PLATED CONTACTS**

description

part No.

part No.

spring terminals with actuator button  
female inserts with female contacts, No. (1-16) and (17-32)  
male inserts with male contacts, No. (1-16) and (17-32)

**CMSHF 06**  
**CMSHM 06**

**CMSHF 06 N**  
**CMSHM 06 N**

- characteristics according to EN 61984:

- 16A 830V 8kV 3**
- 16A 1000V 8kV 2**
- 16A 720/1250V 8kV 2**
- auxiliary contacts: **16A 500V 6kV 3**

- certified

- rated voltage according to UL/CSA: 600V
- insulation resistance:  $\geq 10 \text{ G}\Omega$
- ambient temperature limit:  $-40 \text{ }^\circ\text{C} \dots +125 \text{ }^\circ\text{C}$
- made of self-extinguishing thermoplastic resin UL 94V-0
- mechanical life:  $\geq 500$  cycles
- contact resistance:  $\leq 3 \text{ m}\Omega$
- for max. current load see the connector inserts derating diagram below; for more information see page 28

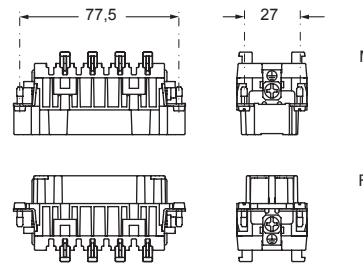

contacts side (front view)

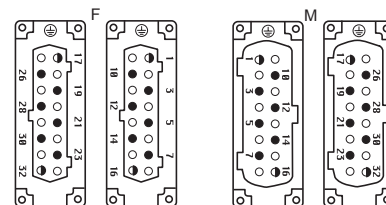

● the auxiliary contacts are in the forward position upon opening

- inserts for section conductors: 0,14 - 2,5 mm<sup>2</sup> - AWG 26 - 14
- conductors stripping length: 9...11 mm

**CMSH 12 poles connector inserts**  
Maximum current load derating diagram

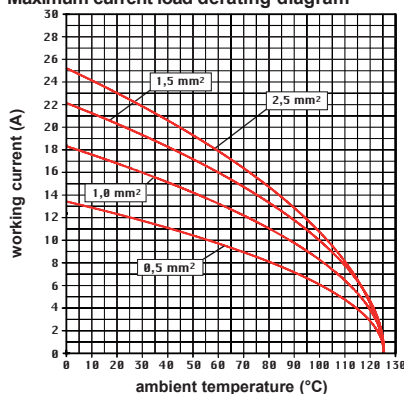

## SQUICH®-spring connection technology

### WIRING

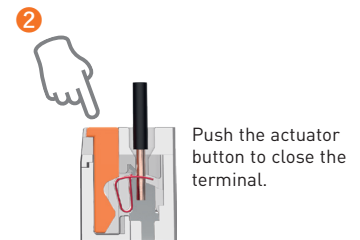
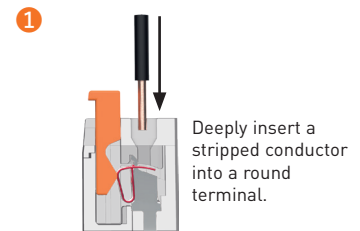

### RE-OPENING

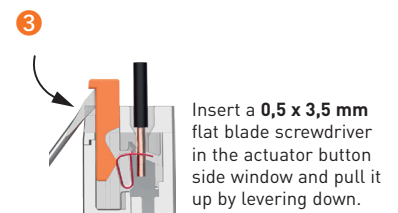

CMSSH-SQUICH® 830V

# CMCE 12 + 4 (aux) poles + ⊕ 16A - 830V

enclosures:  
size "77.62"

page:

C-TYPE IP65/IP66  
W-TYPE for aggressive environments  
E-Xtreme® corrosion proof

424 - 429  
525  
546

## inserts, crimp connections

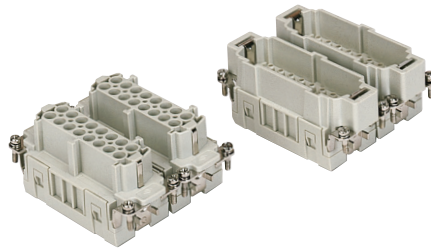

## 16A crimp contacts standard or for advanced opening silver and gold plated

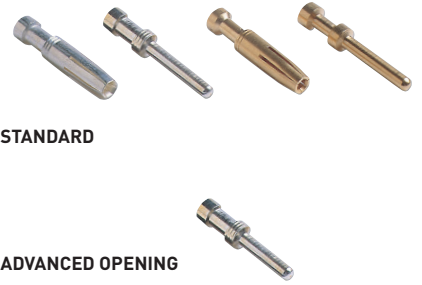

STANDARD

ADVANCED OPENING

description	part No.	part No.	part No.
without contacts (to be ordered separately)			
female inserts for female contacts, No. (1-16) and (17-32)	<b>CMCEF 06</b>	<b>CMCEF 06 N</b>	
male inserts for male contacts, No. (1-16) and (17-32)	<b>CMCEM 06</b>	<b>CMCEM 06 N</b>	
<b>16A female contacts</b>			
0,14-0,37 mm <sup>2</sup> AWG 26-22 one groove			<b>CCFA 0.3</b>
0,5 mm <sup>2</sup> AWG 20 with no grooves			<b>CCFA 0.5</b>
0,75 mm <sup>2</sup> AWG 18 one groove (back side)			<b>CCFA 0.7</b>
1 mm <sup>2</sup> AWG 18 one groove			<b>CCFA 1.0</b>
1,5 mm <sup>2</sup> AWG 16 two grooves			<b>CCFA 1.5</b>
2,5 mm <sup>2</sup> AWG 14 three grooves			<b>CCFA 2.5</b>
3 mm <sup>2</sup> AWG 12 one wide groove			<b>CCFA 3.0</b>
4 mm <sup>2</sup> AWG 12 with no grooves			<b>CCFA 4.0</b>
<b>16A male contacts</b>			
0,14-0,37 mm <sup>2</sup> AWG 26-22 one groove			<b>CCMA 0.3</b>
0,5 mm <sup>2</sup> AWG 20 with no grooves			<b>CCMA 0.5</b>
0,75 mm <sup>2</sup> AWG 18 one groove (back side)			<b>CCMA 0.7</b>
1 mm <sup>2</sup> AWG 18 one groove			<b>CCMA 1.0</b>
1,5 mm <sup>2</sup> AWG 16 two grooves			<b>CCMA 1.5</b>
2,5 mm <sup>2</sup> AWG 14 three grooves			<b>CCMA 2.5</b>
3 mm <sup>2</sup> AWG 12 one wide groove			<b>CCMA 3.0</b>
4 mm <sup>2</sup> AWG 12 with no grooves			<b>CCMA 4.0</b>
<b>16A male crimp contacts for advanced opening</b>			
0,5 mm <sup>2</sup> AWG 20 with no grooves			<b>CC 0.5 AN</b>
0,75 mm <sup>2</sup> AWG 18 one groove (back side)			<b>CC 0.7 AN</b>
1 mm <sup>2</sup> AWG 18 one groove			<b>CC 1.0 AN</b>
1,5 mm <sup>2</sup> AWG 16 two grooves			<b>CC 1.5 AN</b>
2,5 mm <sup>2</sup> AWG 14 three grooves			<b>CC 2.5 AN</b>
			<b>CCFD 0.3</b>
			<b>CCFD 0.5</b>
			<b>CCFD 0.7</b>
			<b>CCFD 1.0</b>
			<b>CCFD 1.5</b>
			<b>CCFD 2.5</b>
			<b>CCFD 3.0</b>
			<b>CCFD 4.0</b>
			<b>CCMD 0.3</b>
			<b>CCMD 0.5</b>
			<b>CCMD 0.7</b>
			<b>CCMD 1.0</b>
			<b>CCMD 1.5</b>
			<b>CCMD 2.5</b>
			<b>CCMD 3.0</b>
			<b>CCMD 4.0</b>
			<b>CC 0.5 AN</b>
			<b>CC 0.7 AN</b>
			<b>CC 1.0 AN</b>
			<b>CC 1.5 AN</b>
			<b>CC 2.5 AN</b>
			* for basic or high thickness gold plating, please refer to page 675

- characteristics according to EN 61984:  
**16A 830V 8kV 3**  
**16A 1000V 8kV 2**  
**16A 720/1250V 8kV 2**
- auxiliary contacts: **16A 500V 6kV 3**
- certified
- rated voltage according to UL/CSA: 600V
- insulation resistance: ≥ 10 GΩ
- ambient temperature limit: -40 °C ... +125 °C
- made of self-extinguishing thermoplastic resin UL 94V-0
- mechanical life: ≥ 500 cycles
- contact resistance: ≤ 1 mΩ
- for max. current load see the connector inserts derating diagram below; for more information see page 28

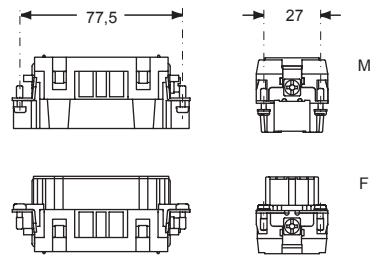

contacts side (front view)

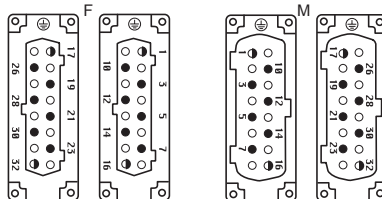

the auxiliary contacts are in the forward position upon opening

- it is recommended to crimp the contacts with crimping tools homologated by ILME (please see the crimping tool section 16A contacts, CCF, CCM and CC...AN series on pages 705 - 741)

### CCF and CCM

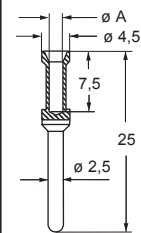

### CC...AN

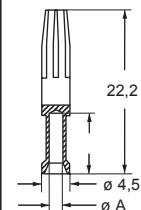
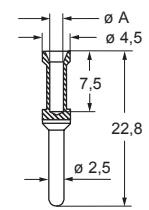

### CCF, CCM and CC...AN contacts

conductor section mm <sup>2</sup>	conductor slot Ø A (mm)	conductors stripping length (mm)
0,14-0,37	0,9	7,5
0,5	1,1	7,5
0,75	1,3	7,5
1,0	1,45	7,5
1,5	1,8	7,5
2,5	2,2	7,5
3	2,55	7,5
4	2,85	7,5

**CMCE 12 poles connector inserts**  
Maximum current load derating diagram

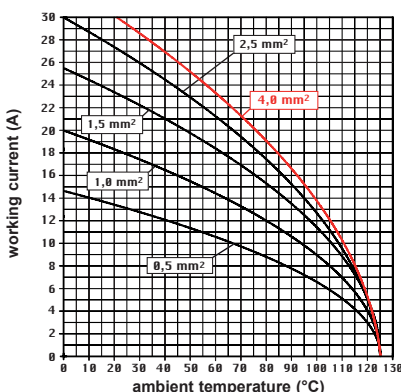

# CMSH-SQUICH® 20 + 4 (aux) poles + ⊕ 16A - 830V

enclosures:  
size "104.62"

page:

C-TYPE IP65/IP66  
W-TYPE for aggressive environments  
E-Xtreme® corrosion proof

430  
526  
547

inserts,  
spring terminal connection without tools

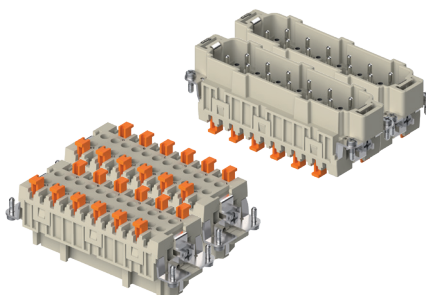

Q SILVER PLATED CONTACTS

description

part No.

part No.

spring terminals with actuator button  
female inserts with female contacts, No. (1-24) and (25-48)  
male inserts with male contacts, No. (1-24) and (25-48)

CMSHF 10  
CMSHM 10

CMSHF 10 N  
CMSHM 10 N

- characteristics according to EN 61984:

- 16A 830V 8kV 3
- 16A 1000V 8kV 2
- 16A 720/1250V 8kV 2

- auxiliary contacts: 16A 500V 6kV 3

- certified

- rated voltage according to UL/CSA: 600V
- insulation resistance:  $\geq 10 \text{ G}\Omega$
- ambient temperature limit:  $-40 \text{ }^\circ\text{C} \dots +125 \text{ }^\circ\text{C}$
- made of self-extinguishing thermoplastic resin UL 94V-0
- mechanical life:  $\geq 500$  cycles
- contact resistance:  $\leq 3 \text{ m}\Omega$

- for max. current load see the connector inserts derating diagram below; for more information see page 28

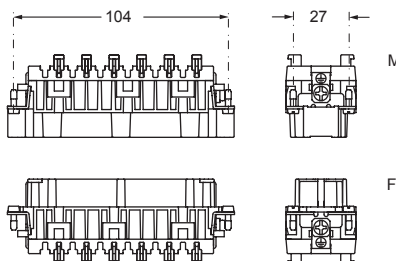

contacts side (front view)

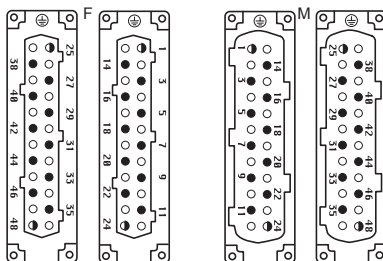

● the auxiliary contacts are in the forward position upon opening

- inserts for section conductors: 0,14 - 2,5 mm<sup>2</sup> - AWG 26 - 14
- conductors stripping length: 9...11 mm

CMSH 20 poles connector inserts  
Maximum current load derating diagram

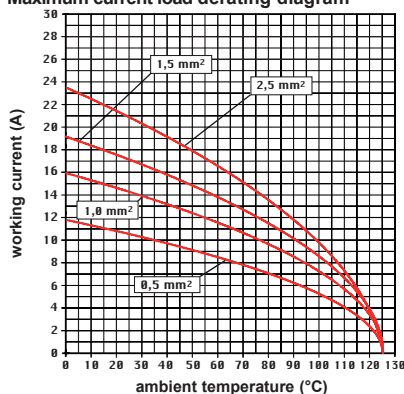

## SQUICH®-spring connection technology

### WIRING

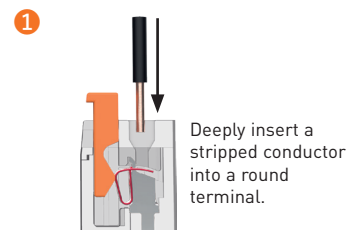

### RE-OPENING

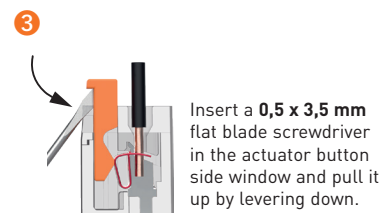

# CMCE 20 + 4 (aux) poles + ⊕ 16A - 830V

enclosures:  
size "104.62" page:

C-TYPE IP65/IP66 430  
W-TYPE for aggressive environments 526  
E-Xtreme® corrosion proof 547

inserts, crimp connections

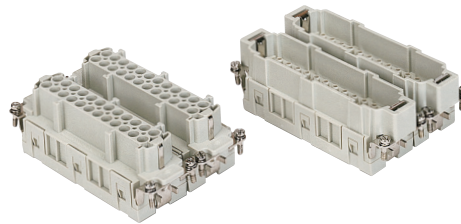

16A crimp contacts  
standard or for advanced opening  
silver and gold plated

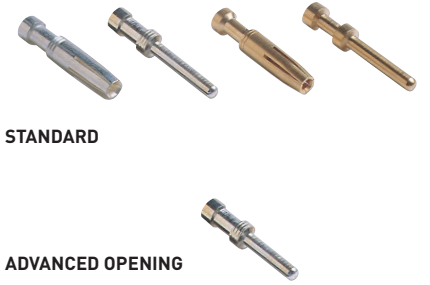

description	part No.	part No.	part No.
without contacts (to be ordered separately)			
female inserts for female contacts, No. (1-24) and (25-48)	<b>CMCEF 10</b>	<b>CMCEF 10 N</b>	
male inserts for male contacts, No. (1-24) and (25-48)	<b>CMCEM 10</b>	<b>CMCEM 10 N</b>	
16A female contacts			
0,14-0,37 mm <sup>2</sup> AWG 26-22 one groove			<b>CCFA 0.3</b> <b>CCFD 0.3</b>
0,5 mm <sup>2</sup> AWG 20 with no grooves			<b>CCFA 0.5</b> <b>CCFD 0.5</b>
0,75 mm <sup>2</sup> AWG 18 one groove (back side)			<b>CCFA 0.7</b> <b>CCFD 0.7</b>
1 mm <sup>2</sup> AWG 18 one groove			<b>CCFA 1.0</b> <b>CCFD 1.0</b>
1,5 mm <sup>2</sup> AWG 16 two grooves			<b>CCFA 1.5</b> <b>CCFD 1.5</b>
2,5 mm <sup>2</sup> AWG 14 three grooves			<b>CCFA 2.5</b> <b>CCFD 2.5</b>
3 mm <sup>2</sup> AWG 12 one wide groove			<b>CCFA 3.0</b> <b>CCFD 3.0</b>
4 mm <sup>2</sup> AWG 12 with no grooves			<b>CCFA 4.0</b> <b>CCFD 4.0</b>
16A male contacts			
0,14-0,37 mm <sup>2</sup> AWG 26-22 one groove			<b>CCMA 0.3</b> <b>CCMD 0.3</b>
0,5 mm <sup>2</sup> AWG 20 with no grooves			<b>CCMA 0.5</b> <b>CCMD 0.5</b>
0,75 mm <sup>2</sup> AWG 18 one groove (back side)			<b>CCMA 0.7</b> <b>CCMD 0.7</b>
1 mm <sup>2</sup> AWG 18 one groove			<b>CCMA 1.0</b> <b>CCMD 1.0</b>
1,5 mm <sup>2</sup> AWG 16t wo grooves			<b>CCMA 1.5</b> <b>CCMD 1.5</b>
2,5 mm <sup>2</sup> AWG 14 three grooves			<b>CCMA 2.5</b> <b>CCMD 2.5</b>
3 mm <sup>2</sup> AWG 12 one wide groove			<b>CCMA 3.0</b> <b>CCMD 3.0</b>
4 mm <sup>2</sup> AWG 12 with no grooves			<b>CCMA 4.0</b> <b>CCMD 4.0</b>
16A male crimp contacts for advanced opening			
0,5 mm <sup>2</sup> AWG 20 with no grooves			<b>CC 0.5 AN</b>
0,75 mm <sup>2</sup> AWG 18 one groove (back side)			<b>CC 0.7 AN</b>
1 mm <sup>2</sup> AWG 18 one groove			<b>CC 1.0 AN</b>
1,5 mm <sup>2</sup> AWG 16 two grooves			<b>CC 1.5 AN</b>
2,5 mm <sup>2</sup> AWG 14 three grooves			<b>CC 2.5 AN</b>

silver plated

gold plated\*

\* for basic or high thickness gold plating, please refer to page 675

- characteristics according to EN 61984:  
**16A 830V 8kV 3**  
**16A 1000V 8kV 2**  
**16A 720/1250V 8kV 2**
- auxiliary contacts: **16A 500V 6kV 3**
- certified
- rated voltage according to UL/CSA: 600V
- insulation resistance: ≥ 10 GΩ
- ambient temperature limit: -40 °C ... +125 °C
- made of self-extinguishing thermoplastic resin UL 94V-0
- mechanical life: ≥ 500 cycles
- contact resistance: ≤ 1 mΩ
- for max. current load see the connector inserts derating diagram below; for more information see page 28

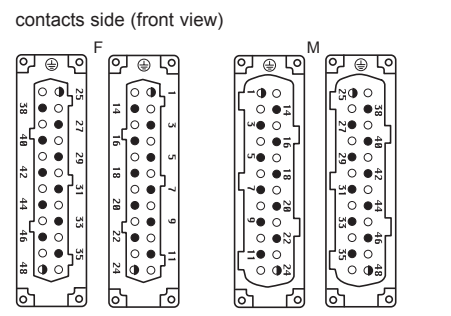
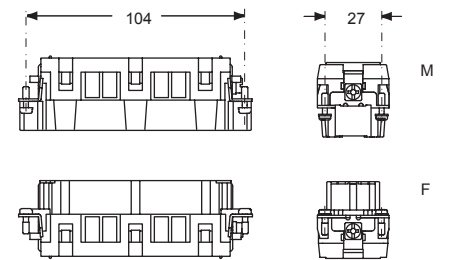
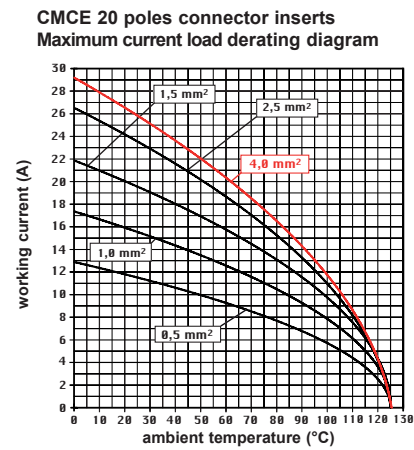

contacts side (front view)

the auxiliary contacts are in the forward position upon opening

- it is recommended to crimp the contacts with crimping tools homologated by ILME (please see the crimping tool section 16A contacts, CCF, CCM and CC...AN series on pages 705 - 741)

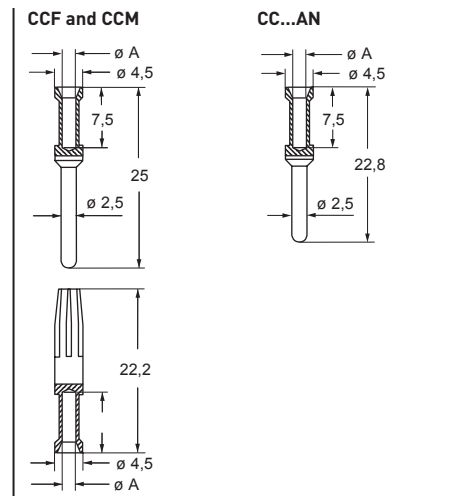

**CCF, CCM and CC...AN contacts**

conductor section mm <sup>2</sup>	conductor slot Ø A (mm)	conductors stripping length (mm)
0,14-0,37	0,9	7,5
0,5	1,1	7,5
0,75	1,3	7,5
1,0	1,45	7,5
1,5	1,8	7,5
2,5	2,2	7,5
3	2,55	7,5
4	2,85	7,5

CMCE 830V



## CSS series

### Connection with dual spring terminal per pole

Series **CSS** is the “two spring clamp terminal per contact” counterpart of series **CSH** connectors, which have one spring-clamp terminal per contact.

In series **CSS** inserts **are made available to the user with two spring clamp terminals per contact** so that two conductors can be connected to each of them.

Series **CSS** inserts share the mating interface (dimensions) with equally sized inserts of series **CNE** (screw-type) **CCE** (crimp type) **CSH** (spring-type with actuator button SQUICH®), **CT** (screw-type with 45° terminal block) and **CTSE** (spring-type with 45° terminal block).

With connectors like **CSS** and suitably developed housings, electric motors can be prepared for the fastest and safest installation. The motor terminal box may be replaced by the specially developed motor connection angled housing **CVI 10 LA** or **MVI 10 LAP32** (see page 450). The “57.27” size for the connector insert and the housing has been chosen to fulfil motor connection requirements.

Star or delta (triangle) bridges may be realized in the mating (free) female connector, realizing simple bridges thanks to the double terminals per pole feature of **CSS**, by short conductors stripped at both ends and “U-bent”. Fast and easy exchange of a motor for maintenance is made easy, reducing costs for downtime.

(\*) **DESINA** standards for **DE**centralized and **St**andardized **IN**stallAtion Technology. This working group was founded by the Association of German Machine Tools Manufacturers (VDW) with the target to develop a field bus independent, standardized installation system for machines and production plants. The task was fulfilled in close cooperation with machine tools manufacturers, the automotive industry and their supply chain. **DESINA** specifications have been transferred to series **ISO 22570** international standards.

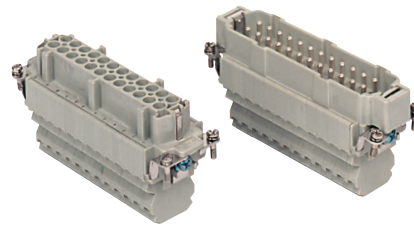

#### SUM-UP

- ☑ **Dual spring terminal per pole**
- ☑ **Two spring clamp terminals per contact**
- ☑ **No special tools are needed**
- ☑ **Suitable for standard hoods/housings size “44.27”, “57.27”, “77.27”, “77.62”, “104.27”, “104.62” high construction versions**
- ☑ **Bridges are made by using a simple 0,5x3,5 mm flat screwdriver to open the spring terminals**
- ☑ **Vibration and shock resistant**
- ☑ **Ideal as motor connectors, as they provide the possibility to connect motor windings in star and delta configuration**
- ☑ **The 10 pole version specified by **DESINA**. Specifications\* and by ISO 22570-1:2009 as type 1 connector for motor connection (6 poles for three-phase star or delta connection + 2 poles for breaking circuit + 2 poles for temperature sensing motor protection circuit)**
- ☑ **Built-in silver plated contacts**



## CSS series

### TECHNICAL FEATURES

Insert series		CSS
No. of poles <sup>1)</sup>	Main contacts + ⊕	<b>6, 10, 16, 24, (32 = 2x16), (48 = 2x24)</b>
	auxiliary contacts	—
Rated current <sup>2)</sup>		16A
EN IEC 61984 Pollution degree 3	rated voltage	500V
	rated impulse voltage	6kV
	<b>pollution degree</b>	<b>3</b>
EN IEC 61984 Pollution degree 2	rated voltage	400/690V
	rated impulse voltage	6kV
	<b>pollution degree</b>	<b>2</b>
UL / CSA certification	rated voltage (a.c./d.c.)	600V
Contact resistance		≤ 3 mΩ
Insulation resistance		≥ 10 GΩ
Ambient temperature limit (°C)	min	-40 °C
	max	+125 °C
Degree of protection	with enclosures	<b>IP65, IP66/IP69, IP66/IP67/IP69, IP66/IP68/IP69</b> (according to type and model)
	without enclosures - termination side on male and female inserts - mating side on female inserts	<b>IP20 (IPXXB)</b>
Conductor connections		spring type
Conductor cross-sectional area	mm <sup>2</sup>	0,14 - 2,5
	AWG	26 - 14
Mechanical endurance (mating cycles)		≥ 500

1) Polarities shown in brackets may be obtained by using two inserts in their own double-sized housings

2) Please check the inserts derating diagrams to establish the actual maximum operating current according to the ambient temperature, the conductor cross-sectional area, the polarity of the connector, and any external constraint may derive e.g. by the continuous operating temperature sustained by the chosen conductor sheathing or by end-product safety standards fixing max allowed temperature rise on terminals (e.g. 30 K, 45 K or 50 K)

# CSS 6 poles + ⊕ 16A - 500V

enclosures: size "44.27"	page:
C-TYPE IP65/IP66	387 - 392
C7 IP67, single lever	436 - 437
V-TYPE IP65/IP66, single lever	444 - 447
BIG hoods	466 - 467
T-TYPE IP65 insulating	480 - 481
T-TYPE / W IP66 insulating	489
HYGIENIC T-TYPE / H IP66/IP69	501
HYGIENIC T-TYPE / C IP66/IP69, -50 °C	506
W-TYPE for aggressive environments	521
E-Xtreme® corrosion proof	530 - 531, 542, 550 - 551
EMC	578
Central lever	603 - 605
LS-TYPE	618 - 619
IP68	632 - 635
panel supports: COB	page: 652 - 653

inserts,  
connection with dual spring  
terminal per pole

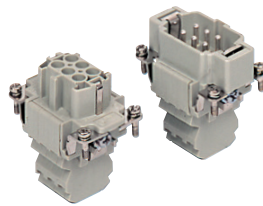

can be mated with CNE, CCE, CTSE, CSH inserts

description	part No.
-------------	----------

dual spring terminal per pole  
female inserts with female contacts  
male inserts with male contacts

CSSF 06  
CSSM 06

The CSS series inserts can be inserted in flush mounted enclosures or in fixed / portable high enclosures.

- characteristics according to EN 61984:

**16A 500V 6kV 3**  
**16A 400/690V 6kV 2**

- certified

- rated voltage according to UL/CSA: 600V
- insulation resistance:  $\geq 10 \text{ G}\Omega$
- ambient temperature limit:  $-40 \text{ }^\circ\text{C} \dots +125 \text{ }^\circ\text{C}$
- made of self-extinguishing thermoplastic resin UL 94V-0
- mechanical life:  $\geq 500$  cycles
- contact resistance:  $\leq 3 \text{ m}\Omega$
- for max. current load see the connector inserts derating diagram below; for more information see page 28

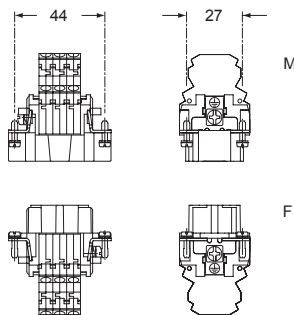

contacts side (front view)

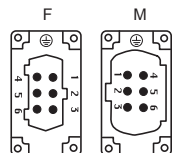

- inserts with plate for section conductors: 0,14 - 2,5 mm<sup>2</sup> - AWG 26 - 14
- conductors stripping length: 9...11 mm

## Connection technology

### step 1

When the screwdriver is inserted in the square housing provided, the wire housing in the spring is opened



### step 2

The wire is pushed all the way in the round housing provided

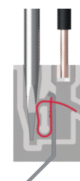

### step 3

When the screwdriver is removed, the spring is held down on the inserted wire



### step 4

The connection is complete; pull on the wire to make sure that the spring firmly holds down the wire



CSS 06 poles connector inserts  
Maximum current load derating diagram

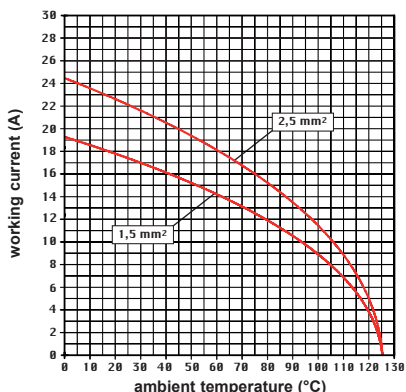

# CSS 10 poles + ⊕ 16A - 500V

enclosures: size "57.27"	page:
C-TYPE IP65/IP66	393 - 401
C7 IP67, two levers	438
V-TYPE IP65/IP66, single lever	448 - 453
BIG hoods	468 - 469
T-TYPE IP65 insulating	482 - 483
T-TYPE / W IP66 insulating	490
HYGIENIC T-TYPE / H IP66/IP69	502
HYGIENIC T-TYPE / C IP66/IP69, -50 °C	507
W-TYPE for aggressive environments	522
E-Xtreme® corrosion proof	532 - 533, 543, 552 - 553
EMC	579
Central lever	606 - 608
LS-TYPE	620 - 621
IP68	636 - 639
panel supports: COB	page: 652 - 653

## inserts, connection with dual spring terminal per pole

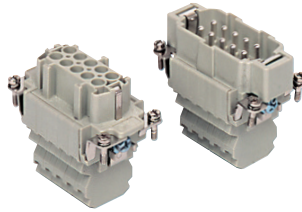

can be mated with CNE, CCE, CTSE, CSH inserts

description	part No.
-------------	----------

dual spring terminal per pole  
female inserts with female contacts  
male inserts with male contacts

**CSSF 10**  
**CSSM 10**

The CSS series inserts can be inserted in flush mounted enclosures or in fixed / portable high enclosures.

- characteristics according to EN 61984:

**16A 500V 6kV 3**  
**16A 400/690V 6kV 2**

- certified

- rated voltage according to UL/CSA: 600V

- insulation resistance:  $\geq 10 \text{ G}\Omega$

- ambient temperature limit:  $-40 \text{ }^\circ\text{C} \dots +125 \text{ }^\circ\text{C}$

- made of self-extinguishing thermoplastic resin  
UL 94V-0

- mechanical life:  $\geq 500$  cycles

- contact resistance:  $\leq 3 \text{ m}\Omega$

- for max. current load see the connector inserts derating diagram below; for more information see page 28

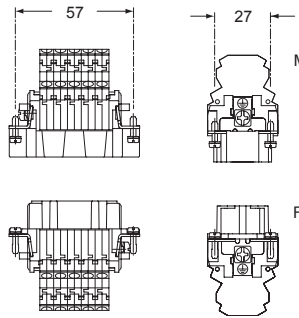

contacts side (front view)

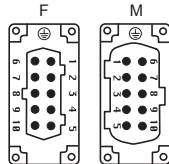

- inserts with plate for section conductors: 0,14 - 2,5 mm<sup>2</sup> - AWG 26 - 14
- conductors stripping length: 9...11 mm

**CSS 10 poles connector inserts**  
**Maximum current load derating diagram**

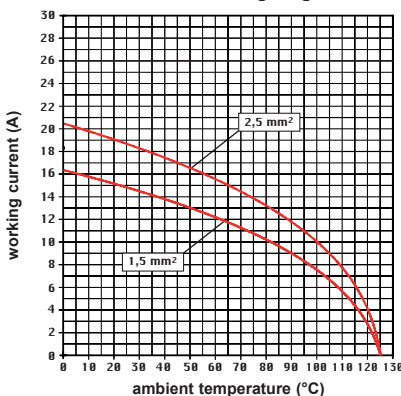

## Connection technology

### step 1

When the screwdriver is inserted in the square housing provided, the wire housing in the spring is opened



### step 2

The wire is pushed all the way in the round housing provided

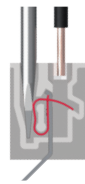

### step 3

When the screwdriver is removed, the spring is held down on the inserted wire



### step 4

The connection is complete; pull on the wire to make sure that the spring firmly holds down the wire



# CSS 16 poles + ⊕ 16A - 500V

enclosures: size "77.27"	page:
C-TYPE IP65/IP66	402 - 411
C7 IP67, two levers	439 - 440
V-TYPE IP65/IP66, single lever	454 - 458
BIG hoods	470 - 471
T-TYPE IP65 insulating	484 - 485
T-TYPE / W IP66 insulating	491
HYGIENIC T-TYPE / H IP66/IP69	503
HYGIENIC T-TYPE / C IP66/IP69, -50 °C	508
W-TYPE for aggressive environments	523
E-Xtreme® corrosion proof	534 - 535, 544, 554 - 555
EMC	580
Central lever	609 - 611
LS-TYPE	622 - 623
IP68	640 - 643
panel supports:	page:
COB	652 - 653

inserts,  
connection with dual spring  
terminal per pole

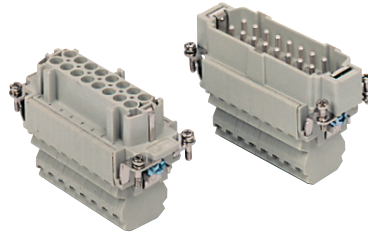

can be mated with CNE, CCE, CTSE, CSH inserts

description	part No.
-------------	----------

dual spring terminal per pole  
female inserts with female contacts  
male inserts with male contacts

CSSF 16  
CSSM 16

The CSS series inserts can be inserted in flush mounted enclosures or in fixed / portable high enclosures.

- characteristics according to EN 61984:  
**16A 500V 6kV 3**  
**16A 400/690V 6kV 2**
- certified
- rated voltage according to UL/CSA: 600V
- insulation resistance:  $\geq 10 \text{ G}\Omega$
- ambient temperature limit:  $-40 \text{ }^\circ\text{C} \dots +125 \text{ }^\circ\text{C}$
- made of self-extinguishing thermoplastic resin UL 94V-0
- mechanical life:  $\geq 500$  cycles
- contact resistance:  $\leq 3 \text{ m}\Omega$
- for max. current load see the connector inserts derating diagram below; for more information see page 28

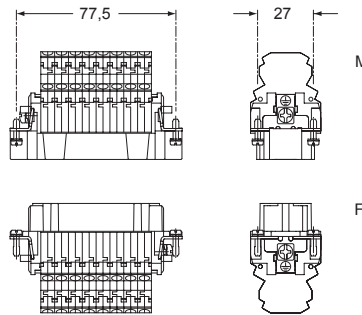

contacts side (front view)

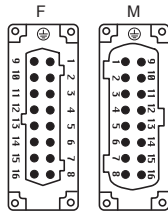

- inserts with plate for section conductors: 0,14 - 2,5 mm<sup>2</sup> - AWG 26 - 14
- conductors stripping length: 9...11 mm

## Connection technology

### step 1

When the screwdriver is inserted in the square housing provided, the wire housing in the spring is opened



### step 2

The wire is pushed all the way in the round housing provided

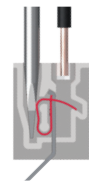

### step 3

When the screwdriver is removed, the spring is held down on the inserted wire

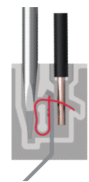

### step 4

The connection is complete; pull on the wire to make sure that the spring firmly holds down the wire



CSS 16 poles connector inserts  
Maximum current load derating diagram

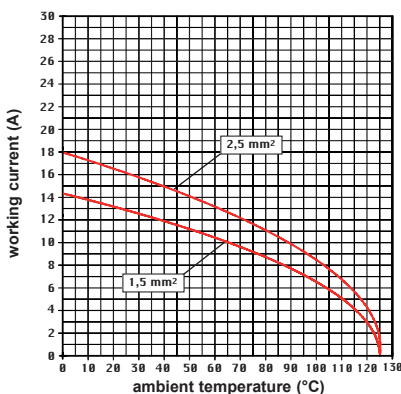

CSS

# CSS 24 poles + ⊕ 16A - 500V

enclosures: size "104.27"	page:
C-TYPE IP65/IP66	412 - 423
C7 IP67, two levers	441 - 442
V-TYPE IP65/IP66, single lever	459 - 463
BIG hoods	472 - 473
T-TYPE IP65 insulating	486 - 487
T-TYPE / W IP66 insulating	492
HYGIENIC T-TYPE / H IP66/IP69	504
HYGIENIC T-TYPE / C IP66/IP69, -50 °C	509
W-TYPE for aggressive environments	524
E-Xtreme® corrosion proof	536 - 537, 545, 556 - 557
EMC	581
Central lever	612 - 614
LS-TYPE	624 - 625
IP68	644 - 647
panel supports: COB	page: 652 - 653

## inserts, connection with dual spring terminal per pole

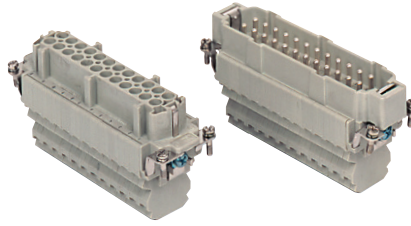

can be mated with CNE, CCE, CTSE, CSH inserts

description	part No.
-------------	----------

dual spring terminal per pole  
female inserts with female contacts  
male inserts with male contacts

**CSSF 24**  
**CSSM 24**

The CSS series inserts can be inserted in flush mounted enclosures or in fixed / portable high enclosures.

- characteristics according to EN 61984:

**16A 500V 6kV 3**  
**16A 400/690V 6kV 2**

- certified

- rated voltage according to UL/CSA: 600V

- insulation resistance: ≥ 10 GΩ

- ambient temperature limit: -40 °C ... +125 °C

- made of self-extinguishing thermoplastic resin  
UL 94V-0

- mechanical life: ≥ 500 cycles

- contact resistance: ≤ 3 mΩ

- for max. current load see the connector inserts derating diagram below; for more information see page 28

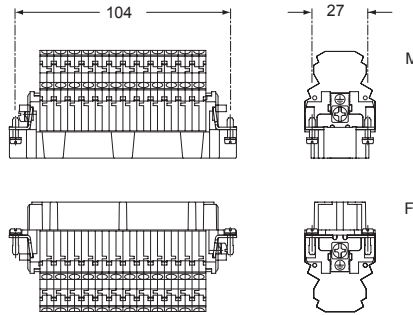

contacts side (front view)

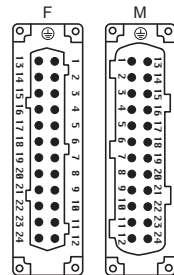

- inserts with plate for section conductors: 0,14 - 2,5 mm<sup>2</sup> - AWG 26 - 14
- conductors stripping length: 9...11 mm

CSS 24 poles connector inserts  
Maximum current load derating diagram

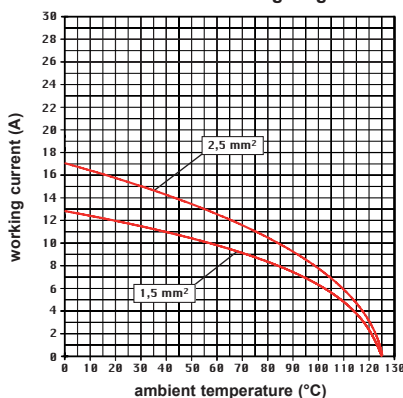

## Connection technology

### step 1

When the screwdriver is inserted in the square housing provided, the wire housing in the spring is opened



### step 2

The wire is pushed all the way in the round housing provided

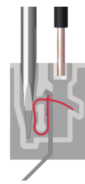

### step 3

When the screwdriver is removed, the spring is held down on the inserted wire



### step 4

The connection is complete; pull on the wire to make sure that the spring firmly holds down the wire



# CSS 32 poles + ⊕ 16A - 500V

enclosures:  
size "77.62"

page:

C-TYPE IP65/IP66  
W-TYPE for aggressive environments  
E-Xtreme® corrosion proof

424 - 429  
525  
546

inserts,  
connection with dual spring  
terminal per pole

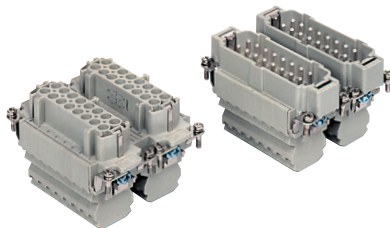

can be mated with CNE, CCE, CTSE, CSH inserts

description

part No.

part No.

dual spring terminal per pole  
female inserts with female contacts, No. (1-16) and (17-32)  
male inserts with male contacts, No. (1-16) and (17-32)

**CSSF 16**  
**CSSM 16**

**CSSF 16 N**  
**CSSM 16 N**

The CSS series inserts can be inserted in flush mounted enclosures or in fixed / portable high enclosures.

- characteristics according to EN 61984:

**16A 500V 6kV 3**

**16A 400/690V 6kV 2**

- certified

- rated voltage according to UL/CSA: 600V

- insulation resistance:  $\geq 10 \text{ G}\Omega$

- ambient temperature limit:  $-40 \text{ }^\circ\text{C} \dots +125 \text{ }^\circ\text{C}$

- made of self-extinguishing thermoplastic resin  
UL 94V-0

- mechanical life:  $\geq 500$  cycles

- contact resistance:  $\leq 3 \text{ m}\Omega$

- for max. current load see the connector inserts derating diagram below; for more information see page 28

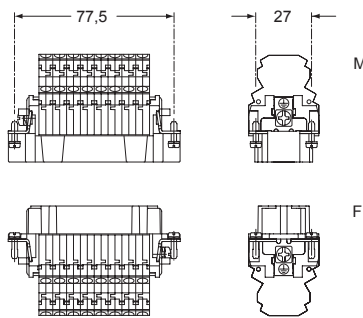

contacts side (front view)

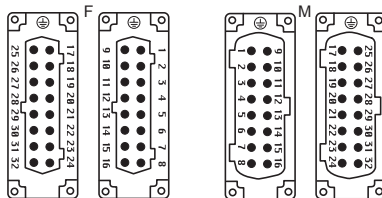

- inserts with plate for section conductors: 0,14 - 2,5 mm<sup>2</sup> - AWG 26 - 14
- conductors stripping length: 9...11 mm

## Connection technology

### step 1

When the screwdriver is inserted in the square housing provided, the wire housing in the spring is opened



### step 2

The wire is pushed all the way in the round housing provided



### step 3

When the screwdriver is removed, the spring is held down on the inserted wire

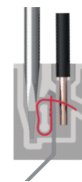

### step 4

The connection is complete; pull on the wire to make sure that the spring firmly holds down the wire



CSS 32 poles connector inserts  
Maximum current load derating diagram

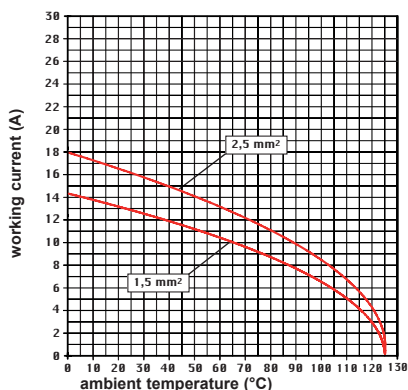



# CSS 48 poles + ⊕ 16A - 500V

enclosures:  
size "104.62"

page:

C-TYPE IP65/IP66  
W-TYPE for aggressive environments  
E-Xtreme® corrosion proof

430  
526  
547

inserts,  
connection with dual spring  
terminal per pole

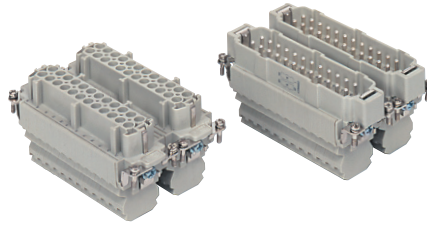

can be mated with CNE, CCE, CTSE, CSH inserts

description	part No.	part No.
spring terminals with actuator button	CSSF 24	CSSF 24 N
female inserts with female contacts, No. (1-24) and (25-48)	CSSM 24	CSSM 24 N
male inserts with male contacts, No. (1-24) and (25-48)		

The CSS series inserts can be inserted in flush mounted enclosures or in fixed / portable high enclosures.

- characteristics according to EN 61984:

**16A 500V 6kV 3**  
**16A 400/690V 6kV 2**

- certified

- rated voltage according to UL/CSA: 600V

- insulation resistance: ≥ 10 GΩ

- ambient temperature limit: -40 °C ... +125 °C

- made of self-extinguishing thermoplastic resin  
UL 94V-0

- mechanical life: ≥ 500 cycles

- contact resistance: ≤ 3 mΩ

- for max. current load see the connector inserts derating diagram below; for more information see page 28

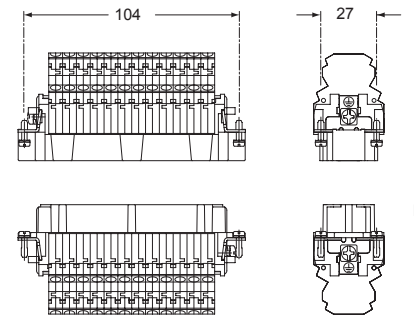

contacts side (front view)

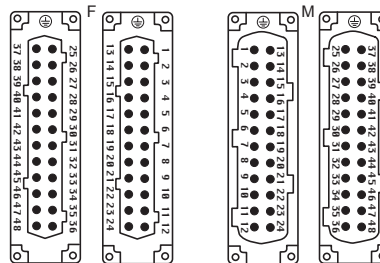

- inserts with plate for section conductors: 0,14 - 2,5 mm<sup>2</sup> - AWG 26 - 14
- conductors stripping length: 9...11 mm

CSS 48 poles connector inserts  
Maximum current load derating diagram

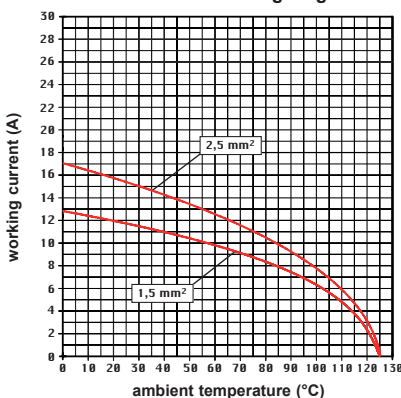

## Connection technology

### step 1

When the screwdriver is inserted in the square housing provided, the wire housing in the spring is opened



### step 2

The wire is pushed all the way in the round housing provided

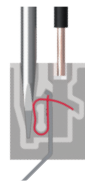

### step 3

When the screwdriver is removed, the spring is held down on the inserted wire



### step 4

The connection is complete; pull on the wire to make sure that the spring firmly holds down the wire



## Inserts with incorporated terminal block for multipole connectors (10A max versions)

CT series multipole connectors (with incorporated 45° terminal block) are recommended for greater cost-saving and safety for use on machines and command and control panels.

For control panel mounting, bulkhead housings must be used.

CT series inserts (10A max versions) are supplied in the plug or socket versions and must be mounted with insertion from the rear of the enclosure (Figures 1 and 2), as the space occupied by the terminal block does not allow for the passage of the insert and insertion from the front of the enclosure.

As an alternative to the traditional terminal blocks, the inserts can be mounted inside the control panels on DIN EN 60715 rails (Figure 5) using suitable accessories providing the added advantage of easy sectioning.

The special structure of CT inserts provides all the conductor connections on the same side, achieving easier wiring and a complete view of the work area.

The 45° terminal block has also slots for housing the identification wire markers of each contact.

Wire markers of different manufacturers may be used such as: Cabur, Grafoplast, Modernotecnica, Phoenix Contact, Siemens, Wago, Weidmüller.

CT series is available in the versions "left-hand" and "right-hand" for mounting on the left (Figure 3) or on the right (Figure 4) of the control panel walls.

This characteristic is determined by the position of contact "1" and the protective earth terminal in the upper part of the insert terminal block for both left and right mounting.

The installation of inserts on DIN rails (Figure 5) inside the control panels is usually made to ease the wiring in sectionable parts.

In this case the degree of protection for coupled connectors is IP20 (in accordance with EN 60529).

This type of mounting requires supports (CT APE) suitable for mounting on DIN EN 60715 rail. to be provided to the inserts.

In addition, CRBF (female) and CRBM (male) coupling screws instead of normal screws are recommended for fixing the inserts to the enclosures (Figure 5) in order to guarantee a stable and safe coupling between the CT and CTS inserts installed on the DIN rails and corresponding mating CD inserts.

**Figures 1 and 2** (rear mounting)

The insert is inserted into the bulkhead housing with pre-wired conductors connected at the opposite end

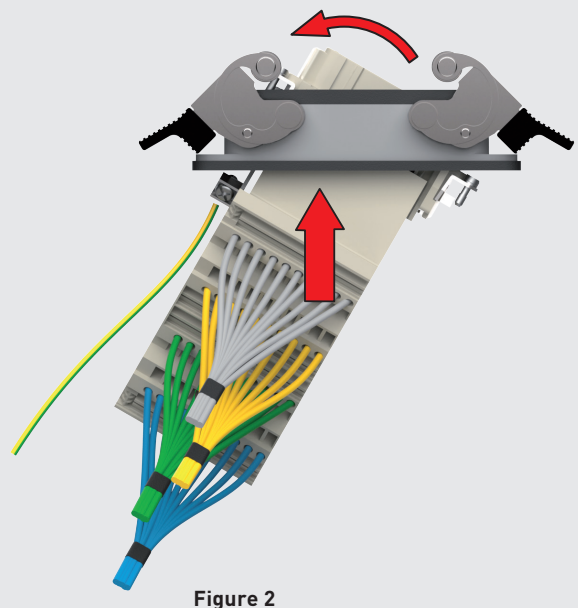
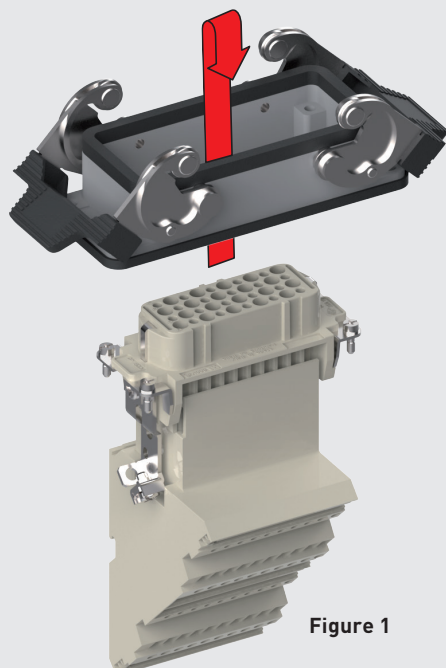
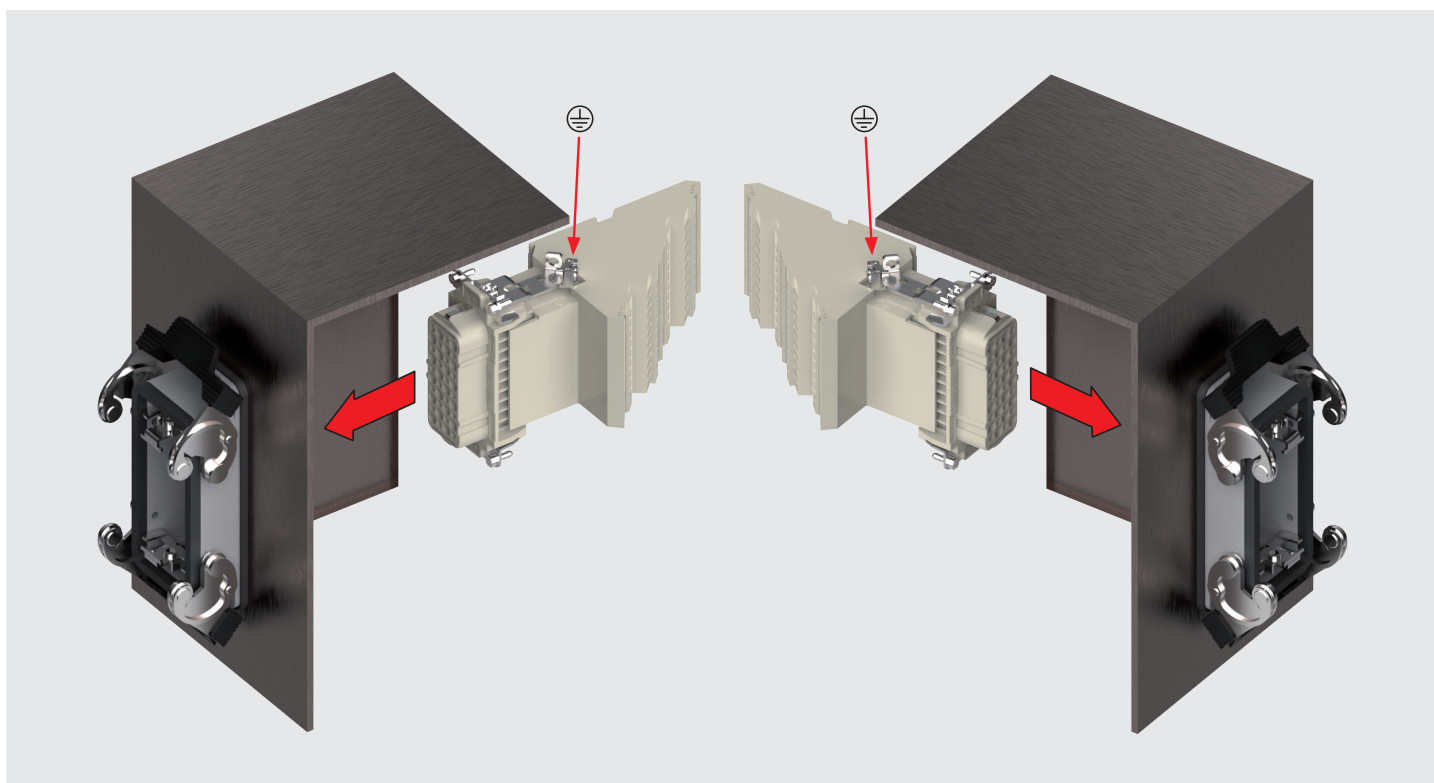

Figure 3 (left mounting)

Figure 4 (right mounting)



CT - CTS

Figure 5 (mounting on DIN rail)

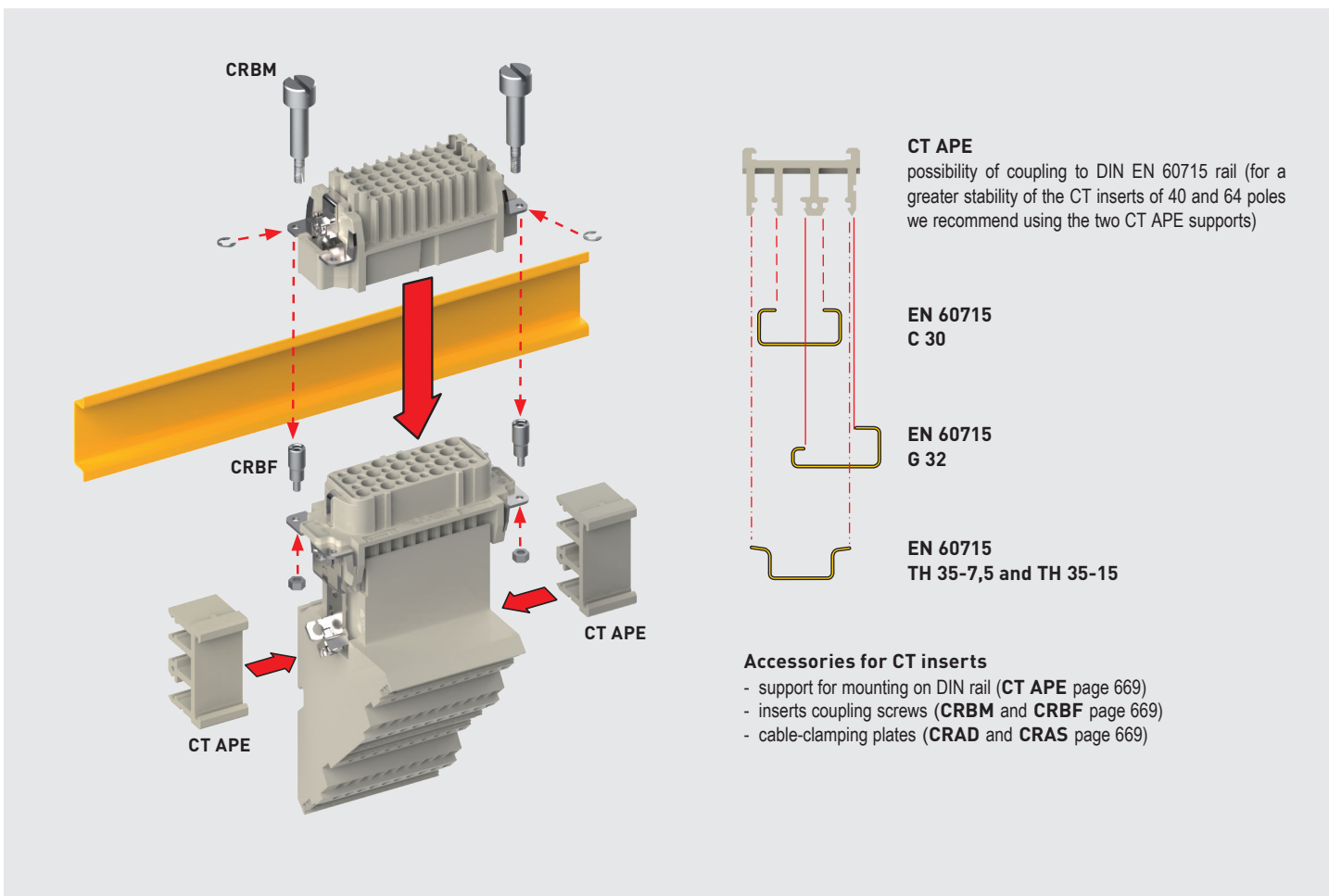

# CT - CTS 40 poles + ⊕ 10A - 250V

enclosures \*):  
size "77.27"

page:

C-TYPE IP65/IP66	402
C7 IP67, two levers	439 - 440
V-TYPE IP65/IP66, single lever	454 - 455
W-TYPE for aggressive environments	523
E-Xtreme® corrosion proof	534, 544
EMC	580
Central lever	609
LS-TYPE	622

\*) only bulkhead mounted housings

- can be mated with CD inserts
- rear-mounted inserts

## terminal block inserts screw terminal connection

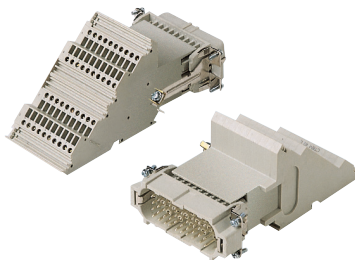

## Q SILVER PLATED CONTACTS

## terminal block inserts spring terminal connection

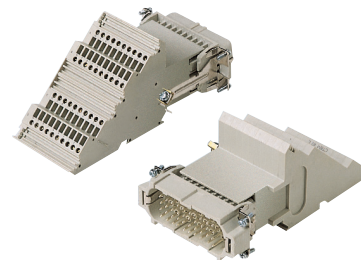

## Q SILVER PLATED CONTACTS

description	part No.	part No.	part No.	part No.
side-mounting (see page 155) female inserts with female contacts <sup>1)</sup> male inserts with male contacts <sup>1)</sup>	left <b>CTF 40 L</b> <b>CTM 40 L</b>	right <b>CTF 40 R</b> <b>CTM 40 R</b>	left <b>CTSF 40 L</b> <b>CTSM 40 L</b>	right <b>CTSF 40 R</b> <b>CTSM 40 R</b>

1) for non-prepared conductors

- characteristics according to EN 61984:

**10A 250V 4kV 3**  
**10A 230/400V 4kV 2**

- certified

- (CT) (CTS) certified

- rated voltage according to UL/CSA: 600V

- insulation resistance: ≥ 10 GΩ

- ambient temperature limit: -40 °C ... +125 °C

- made of self-extinguishing thermoplastic resin  
UL 94V-0

- mechanical life: ≥ 500 cycles

- contact resistance: ≤ 4 mΩ

- for max. current load see the connector inserts derating diagram below; for more information see page 28

### female inserts (CTF and CTSF)

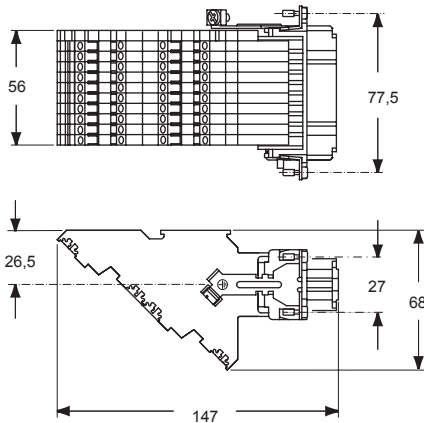

contacts side (front view)

### female inserts (CTF and CTSF)

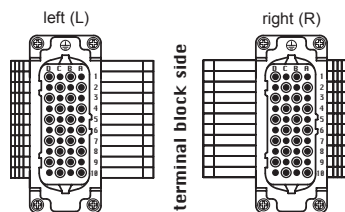

### male inserts (CTM and CTSM)

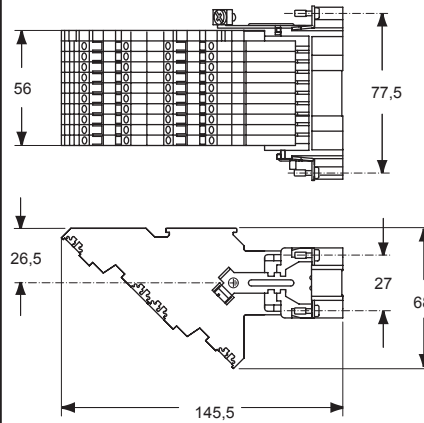

### male inserts (CTM and CTSM)

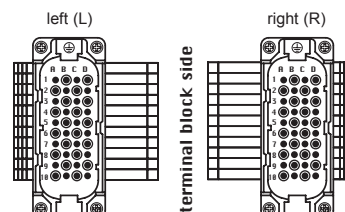

CT and CTS 40 poles connector inserts  
Maximum current load derating diagram

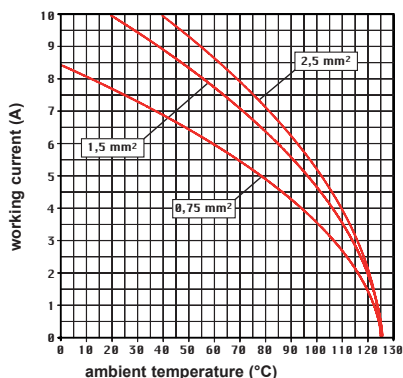

- CT inserts with plate, for section conductors: 0,75 - 2,5 mm<sup>2</sup> - AWG 18 - 14
- conductors stripping length: 12 mm
- terminal screw torque: 0,4 Nm (3,54 lb.in), for more information see page 20 and 21

- CTS spring inserts for section conductors:  
effective sections for non-prepared conductors 0,14 - 2,5 mm<sup>2</sup> - AWG 26 - 14  
effective sections for prepared conductors 0,14 - 1 mm<sup>2</sup> - AWG 26 - 18  
- conductors stripping length: 9...11 mm

# CT - CTS 64 poles + ⊕ 10A - 250V

enclosures \*):  
size "104.27"

page:

C-TYPE IP65/IP66	412
C7 IP67, two levers	441 - 442
V-TYPE IP65/IP66, single lever	459 - 460
W-TYPE for aggressive environments	524
E-Xtreme® corrosion proof	536, 545
EMC	581
Central lever	612
LS-TYPE	624

\*) only bulkhead mounted housings

- can be mated with CD inserts
- rear-mounted inserts

## terminal block inserts screw terminal connection

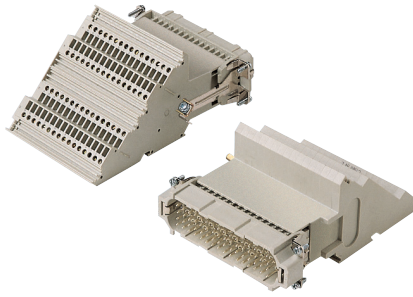

### Q SILVER PLATED CONTACTS

## terminal block inserts spring terminal connection

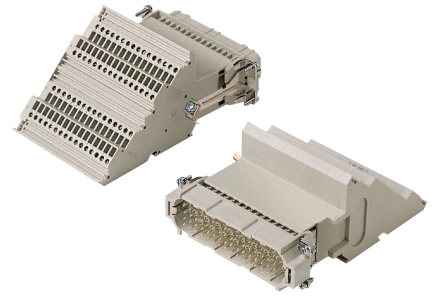

### Q SILVER PLATED CONTACTS

description	part No.	part No.	part No.	part No.
side-mounting (see page 155) female inserts with female contacts <sup>1)</sup> male inserts with male contacts <sup>1)</sup>	left <b>CTF 64 L</b> <b>CTM 64 L</b>	right <b>CTF 64 R</b> <b>CTM 64 R</b>	left <b>CTS F 64 L</b> <b>CTS M 64 L</b>	right <b>CTS F 64 R</b> <b>CTS M 64 R</b>

<sup>1)</sup> for non-prepared conductors

- characteristics according to EN 61984:

**10A 250V 4kV 3**  
**10A 230/400V 4kV 2**

- certified

- (CT) (CTS) certified

- rated voltage according to UL/CSA: 600V

- insulation resistance: ≥ 10 GΩ

- ambient temperature limit: -40 °C ... +125 °C

- made of self-extinguishing thermoplastic resin

UL 94V-0

- mechanical life: ≥ 500 cycles

- contact resistance: ≤ 4 mΩ

- for max. current load see the connector inserts derating diagram below; for more information see page 28

### female inserts (CTF and CTSF)

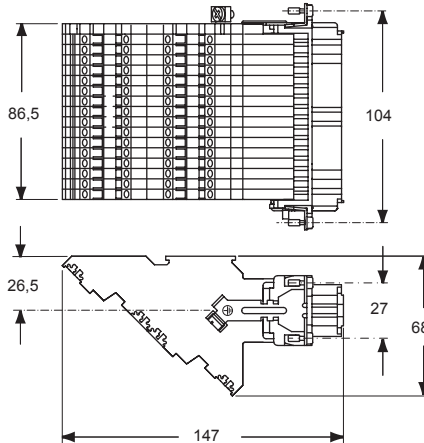

contacts side (front view)

### female inserts (CTF and CTSF)

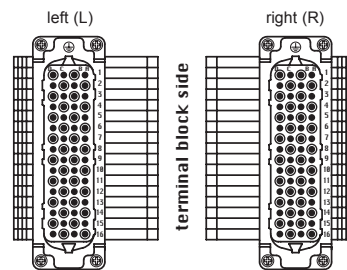

### male inserts (CTM and CTSM)

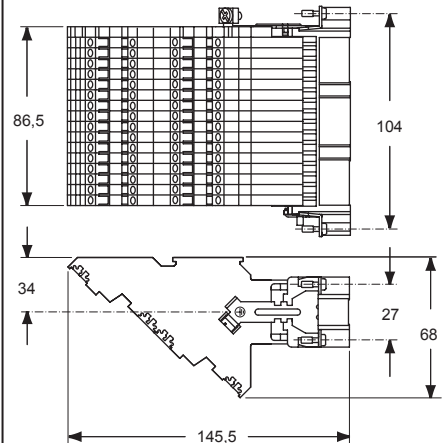

### male inserts (CTM and CTSM)

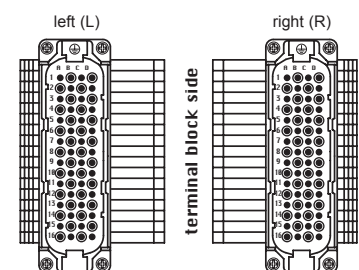

CT and CTS 64 poles connector inserts  
Maximum current load derating diagram

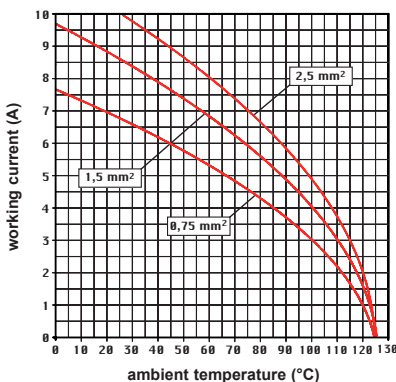

- CT inserts with plate, for section conductors: 0,75 - 2,5 mm<sup>2</sup> - AWG 18 - 14
- conductors stripping length: 9...11 mm
- terminal screw torque: 0,4 Nm (3,54 lb.in), for more information see page 20 and 21

- CTS spring inserts for section conductors: effective sections for non-prepared conductors 0,14 - 2,5 mm<sup>2</sup> - AWG 26 - 14
- effective sections for prepared conductors 0,14 - 1 mm<sup>2</sup> - AWG 26 - 18
- conductors stripping length: 9...11 mm



## Inserts with incorporated terminal block for multipole connectors (16A max versions)

45° CT - CTSE series multipole connectors (with incorporated terminal block) are recommended for greater cost-saving and safety for use on machines and command and control panels.

The CT - CTSE series inserts (16A max versions) are supplied in the plug or socket versions and may be mounted with insertion from the front of the enclosure (Figure 1 for all the polarities of the inserts) or with insertion from the rear of the enclosure (Figure 2, only for 16 and 24-pole inserts).

As an alternative to the traditional terminal blocks, the inserts can be mounted inside the control panels on DIN EN rails (Figure 5) using suitable accessories providing the added advantage of easy sectioning.

The special structure of the CT - CTSE inserts has all the conductor connections on the same side providing for easier wiring and a complete view of the work area.

The terminal block has also slots for housing the identification wire markers of each contact.

Wire markers of different manufacturers may be used such as: Cabur, Grafoplast, Modernotecnica, Phoenix Contact, Siemens, Wago, Weidmüller.

The CT - CTSE series is available in the versions "left" and "right" for mounting on the left (Figure 3) or on the right (Figure 4) of the control panel walls.

This characteristic is determined by the position of contact "1" and the ground terminal in the upper part of the insert terminal block for both left and right mounting.

The installation of inserts on DIN rails (Figure 5) inside the control panels is usually made to facilitate the wiring into sectionable parts.

In this case the degree of protection for coupled connectors is IP20 (in accordance with EN 60529).

This type of mounting requires supports (CT APE) suitable for mounting on DIN EN 60715 rails.

Furthermore, to ensure a stable and secure mating between the CT and CTSE inserts installed on DIN rails and counterparts CNE, CCE, CSH, CSS mating screws CRBF (female) and CRBM (male) are recommended, to replace the ordinary fastening screws to the enclosures (Figure 5).

**Figure 1** (front mounting)

The insert is inserted into the bulkhead housing without wired conductors or with pre-wired conductors that are not connected at the opposite end.

Mounting for inserts of 06, 10, 16 and 24 poles

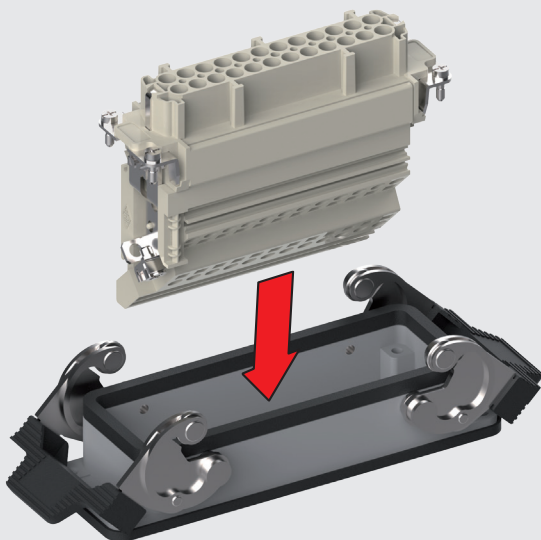

**Figure 2** (rear mounting)

The insert is inserted into the bulkhead housing with pre-wired conductors connected at the opposite end.

Mounting for inserts of 16 and 24 poles

Except version T-TYPE

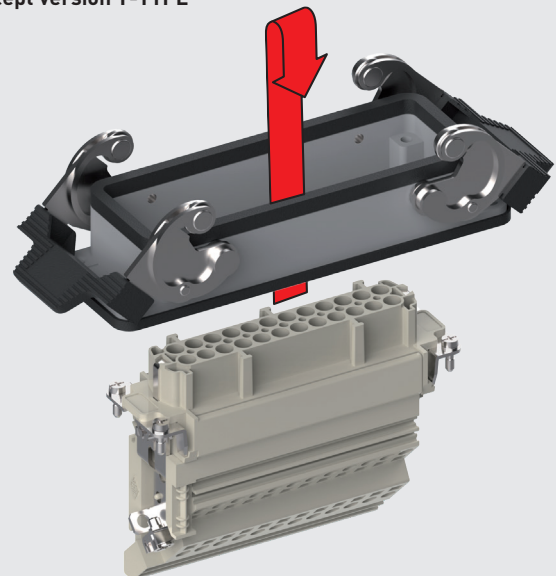
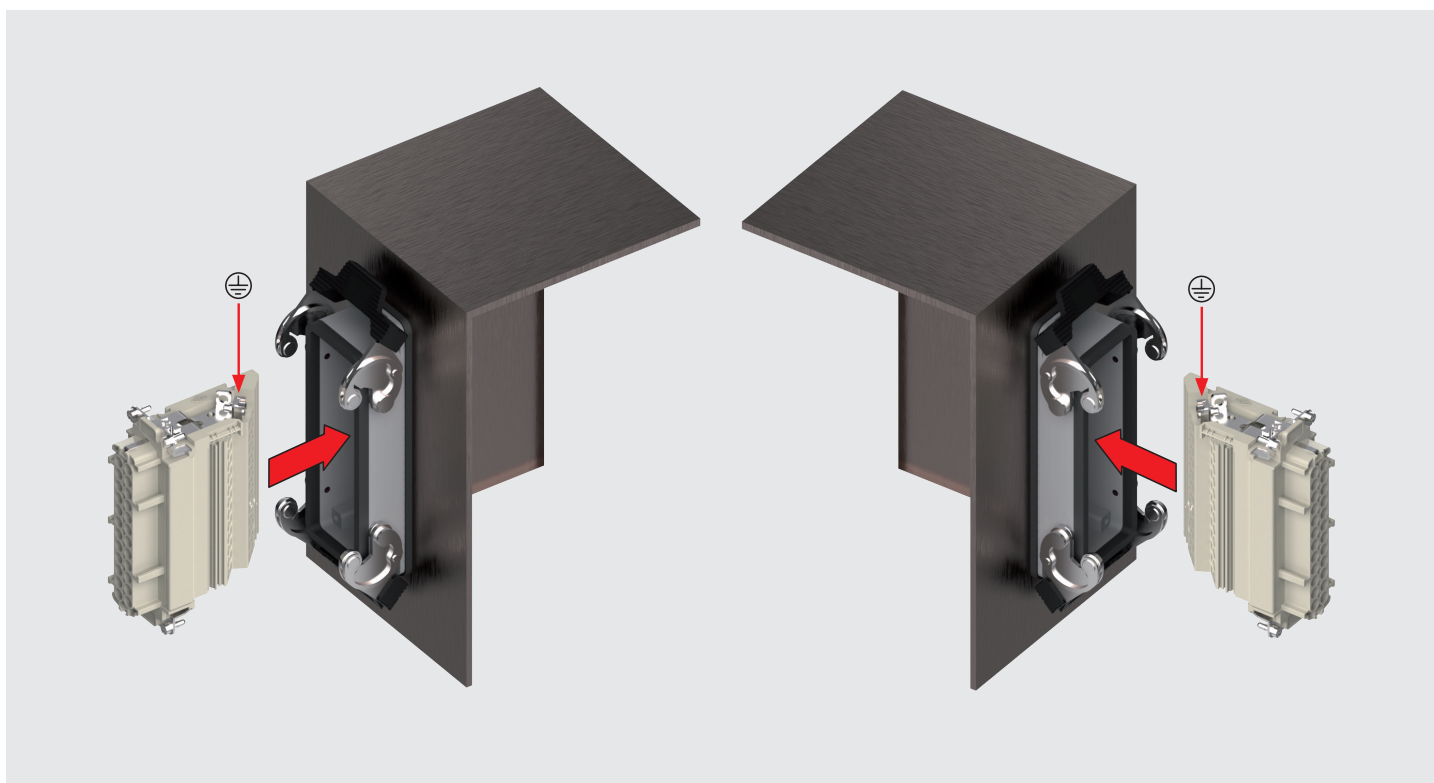



Figure 3 (left mounting)

Figure 4 (right mounting)



CT - CTSE

Figure 5 (mounting on DIN rail)

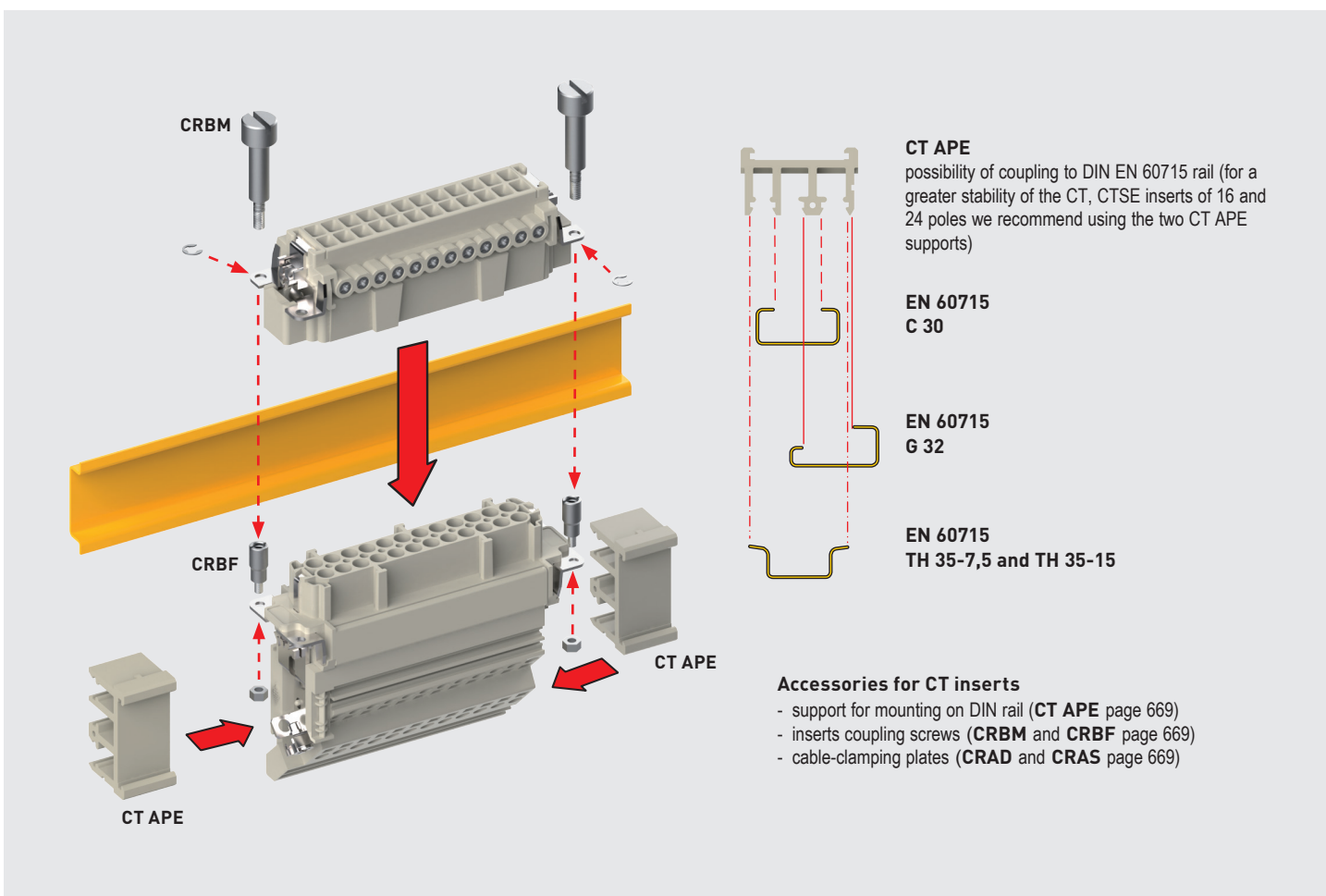

**CT 6 poles + ⊕ 16A - 400V**

**CTSE 6 poles + ⊕ 16A - 500V**

enclosures \*):  
size "44.27"

page:

C-TYPE IP65/IP66	387
C7 IP67, single lever	436 - 437
V-TYPE IP65/IP66, single lever	444 - 445
BIG hoods	466 - 467
T-TYPE IP65 insulating	480 - 481
T-TYPE / W IP66 insulating	489
HYGIENIC T-TYPE / H IP66/IP69	501
HYGIENIC T-TYPE / C IP66/IP69, -50 °C	506
W-TYPE for aggressive environments	521
E-Xtreme® corrosion proof	530, 542
EMC	578
Central lever	603
LS-TYPE	618

\*) only bulkhead mounted housings and BIG hoods

- can be mated with CNE, CCE, CSS, CSH inserts  
- inserts may be fitted from front of enclosure

terminal block inserts  
screw terminal connection

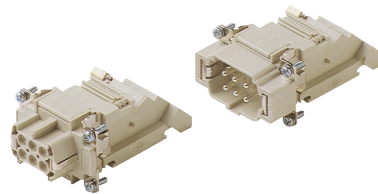

**Q SILVER PLATED CONTACTS**

terminal block inserts  
spring terminal connection

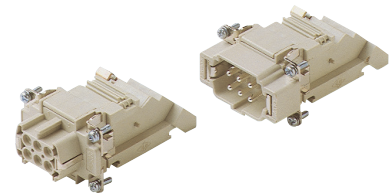

**Q SILVER PLATED CONTACTS**

description	part No.	part No.	part No.	part No.
side mounting (see page 159) female inserts with female contacts <sup>1)</sup> male inserts with male contacts <sup>1)</sup>	left <b>CTF 06 L</b> <b>CTM 06 L</b>	right <b>CTF 06 R</b> <b>CTM 06 R</b>	left <b>CTSEF 06 L</b> <b>CTSEM 06 L</b>	right <b>CTSEF 06 R</b> <b>CTSEM 06 R</b>

1) for non-prepared conductors

- characteristics according to EN 61984:  
**16A 230/400V 4kV 3 (CT)**  
**16A 400V 4kV 2 (CT)**  
**16A 500V 6kV 3 (CTSE)**  
**16A 400/690V 6kV 2 (CTSE)**

certified  
(CT) (CTSE) certified

- rated voltage according to UL/CSA: 600V
- insulation resistance: ≥ 10 GΩ
- ambient temperature limit: -40 °C ... +125 °C
- made of self-extinguishing thermoplastic resin UL 94V-0
- mechanical life: ≥ 500 cycles
- contact resistance: ≤ 4 mΩ
- for max. current load see the connector inserts derating diagrams below; for more information see page 28

**CT 06 poles connector inserts**  
Maximum current load derating diagram

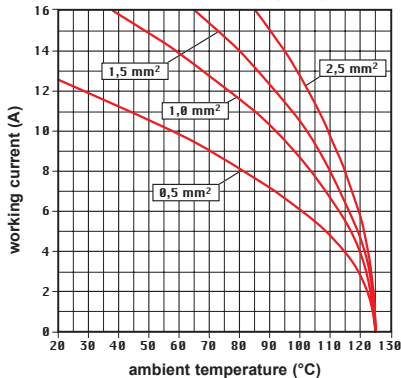

**CTSE 06 poles connector inserts**  
Maximum current load derating diagram

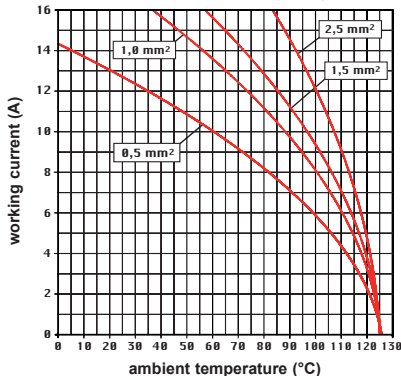

female inserts (CTF and CTSEF)

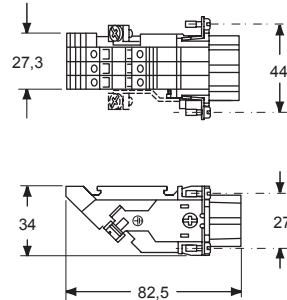

contacts side (front view)

female inserts (CTF and CTSEF)

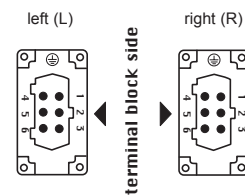

- CT inserts with plate, for section conductors: 0,75 - 2,5 mm² - AWG 18 - 14
- conductors stripping length: 12 mm
- terminal screw torque: 0,4 Nm (3,54 lb.in), for more information see page 20 and 21

male inserts (CTM and CTSEM)

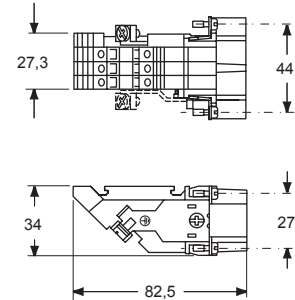

male inserts (CTM and CTSEM)

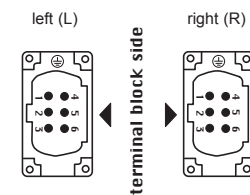

- CTSE spring inserts for section conductors: 0,14 - 2,5 mm² - AWG 26 - 14
- conductors stripping length: 9...11 mm

CT - CTSE

**CT 10 poles + ⊕ 16A - 400V CTSE 10 poles + ⊕ 16A - 500V**

enclosures *): size "57.27"	page:
C-TYPE IP65/IP66	393
C7 IP67, two levers	438
V-TYPE IP65/IP66, single lever	448 - 449
BIG hoods	468 - 469
T-TYPE IP65 insulating	482 - 483
T-TYPE / W IP66 insulating	490
HYGIENIC T-TYPE / H IP66/IP69	502
HYGIENIC T-TYPE / C IP66/IP69, -50 °C	507
W-TYPE for aggressive environments	522
E-Xtreme® corrosion proof	532, 543
EMC	579
Central lever	606
LS-TYPE	620

\*) only bulkhead mounted housings and BIG hoods

- can be mated with CNE, CCE, CSS, CSH inserts  
- inserts may be fitted from front of enclosure

**terminal block inserts  
screw terminal connection**

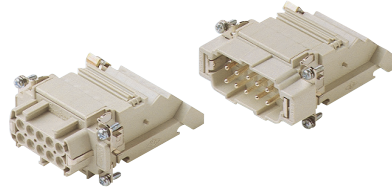

**Q SILVER PLATED CONTACTS**

**terminal block inserts  
spring terminal connection**

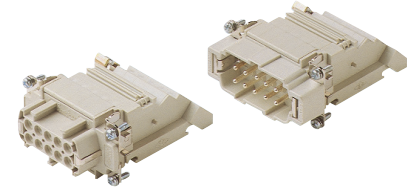

**Q SILVER PLATED CONTACTS**

description	part No.	part No.	part No.	part No.
side mounting (see page 159) female inserts with female contacts <sup>1)</sup> male inserts with male contacts <sup>1)</sup>	left <b>CTF 10 L</b> <b>CTM 10 L</b>	right <b>CTF 10 R</b> <b>CTM 10 R</b>	left <b>CTSEF 10 L</b> <b>CTSEM 10 L</b>	right <b>CTSEF 10 R</b> <b>CTSEM 10 R</b>

1) for non-prepared conductors

- characteristics according to EN 61984:  
**16A 230/400V 4kV 3 (CT)**  
**16A 400V 4kV 2 (CT)**  
**16A 500V 6kV 3 (CTSE)**  
**16A 400/690V 6kV 2 (CTSE)**

certified

- (CT) (CTSE) certified
- rated voltage according to UL/CSA: 600V
- insulation resistance: ≥ 10 GΩ
- ambient temperature limit: -40 °C ... +125 °C
- made of self-extinguishing thermoplastic resin UL 94V-0
- mechanical life: ≥ 500 cycles
- contact resistance: ≤ 4 mΩ
- for max. current load see the connector inserts derating diagrams below; for more information see page 28

**female inserts (CTF and CTSEF)**

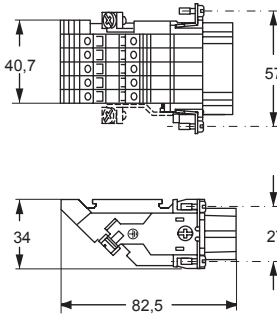

**male inserts (CTM and CTSEM)**

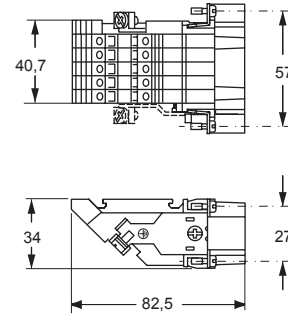

contacts side (front view)

**female inserts (CTF and CTSEF)**

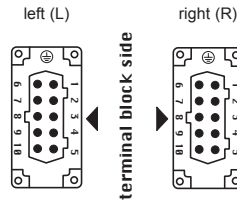

**male inserts (CTM and CTSEM)**

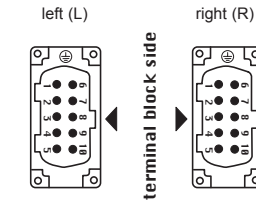

- CT inserts with plate, for section conductors: 0,75 - 2,5 mm<sup>2</sup> - AWG 18 - 14
- conductors stripping length: 12 mm
- terminal screw torque: 0,4 Nm (3,54 lb.in), for more information see page 20 and 21

- CTSE spring inserts for section conductors: 0,14 - 2,5 mm<sup>2</sup> - AWG 26 - 14
- conductors stripping length: 9...11 mm

**CT 10 poles connector inserts  
Maximum current load derating diagram**

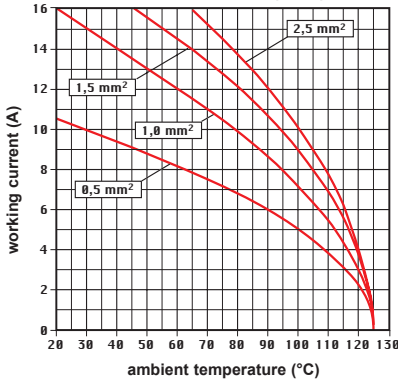

**CTSE 10 poles connector inserts  
Maximum current load derating diagram**

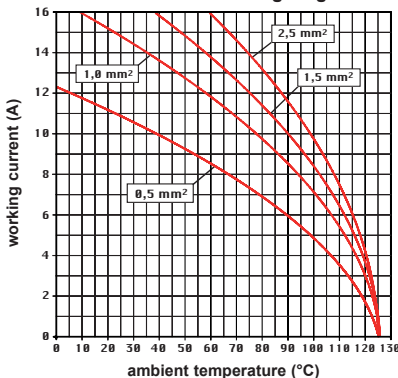

**CT 16 poles + ⊕ 16A - 400V CTSE 16 poles + ⊕ 16A - 500V**

enclosures *): size "77.27"	page:
C-TYPE IP65/IP66	402
C7 IP67, two levers	439 - 440
V-TYPE IP65/IP66, single lever	454 - 455
BIG hoods	470 - 471
T-TYPE IP65 insulating	484 - 485
T-TYPE / W IP66 insulating	491
HYGIENIC T-TYPE / H IP66/IP69	503
HYGIENIC T-TYPE / C IP66/IP69, -50 °C	508
W-TYPE for aggressive environments	523
E-Xtreme® corrosion proof	534, 544
EMC	580
Central lever	609
LS-TYPE	622

\*) only bulkhead mounted housings and BIG hoods

- can be mated with CNE, CCE, CSS, CSH inserts
- inserts may be fitted from front of enclosure

**terminal block inserts  
screw terminal connection**

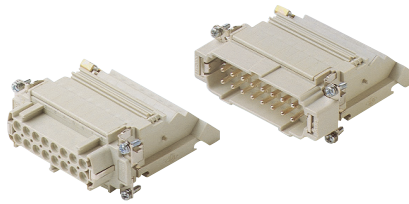

**Q SILVER PLATED CONTACTS**

**terminal block inserts  
spring terminal connection**

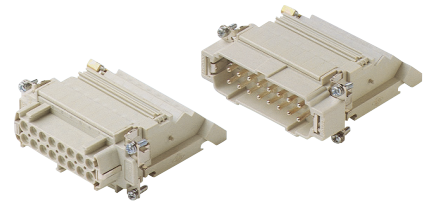

**Q SILVER PLATED CONTACTS**

description	part No.	part No.	part No.	part No.
side mounting (see page 159) female inserts with female contacts <sup>1)</sup> male inserts with male contacts <sup>1)</sup>	left <b>CTF 16 L</b> <b>CTM 16 L</b>	right <b>CTF 16 R</b> <b>CTM 16 R</b>	left <b>CTSEF 16 L</b> <b>CTSEM 16 L</b>	right <b>CTSEF 16 R</b> <b>CTSEM 16 R</b>

1) for non-prepared conductors

- characteristics according to EN 61984:  
**16A 230/400V 4kV 3 (CT)**  
**16A 400V 4kV 2 (CT)**  
**16A 500V 6kV 3 (CTSE)**  
**16A 400/690V 6kV 2 (CTSE)**



- (CT) certified
- (CTSE) certified
- rated voltage according to UL/CSA: 600V
- insulation resistance: ≥ 10 GΩ
- ambient temperature limit: -40 °C ... +125 °C
- made of self-extinguishing thermoplastic resin UL 94V-0
- mechanical life: ≥ 500 cycles
- contact resistance: ≤ 4 mΩ
- for max. current load see the connector inserts derating diagrams below; for more information see page 28

**CT 16 poles connector inserts  
Maximum current load derating diagram**

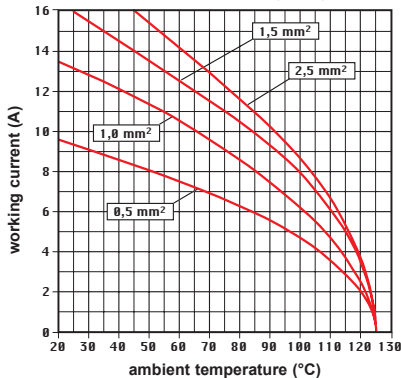

**CTSE 16 poles connector inserts  
Maximum current load derating diagram**

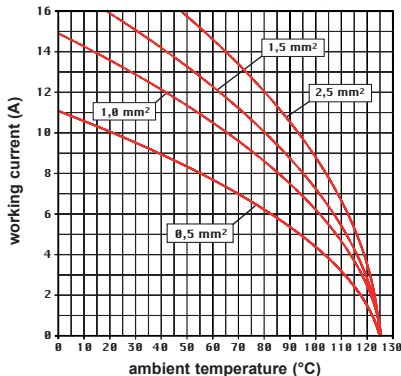

**female inserts (CTF and CTSEF)**

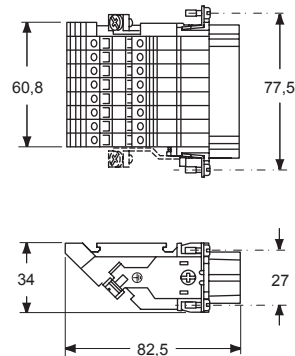

**contacts side (front view)**

**female inserts (CTF and CTSEF)**

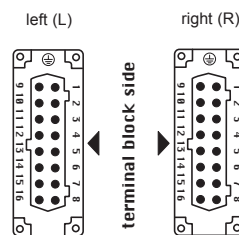

**male inserts (CTM and CTSEM)**

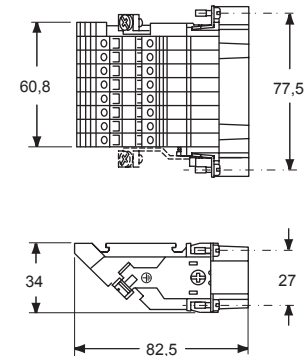

**male inserts (CTM and CTSEM)**

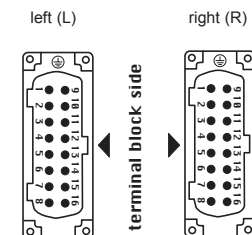

- CT inserts with plate, for section conductors: 0,75 - 2,5 mm² - AWG 18 - 14
- conductors stripping length: 12 mm
- terminal screw torque: 0,4 Nm (3,54 lb.in), for more information see page 20 and 21

- CTSE spring inserts for section conductors: 0,14 - 2,5 mm² - AWG 26 - 14
- conductors stripping length: 9...11 mm

CT - CTSE

**CT 24 poles + ⊕ 16A - 400V CTSE 24 poles + ⊕ 16A - 500V**

enclosures *): size "104.27"	page:
C-TYPE IP65/IP66	412
C7 IP67, two levers	441 - 442
V-TYPE IP65/IP66, single lever	459 - 460
BIG hoods	472 - 473
T-TYPE IP65 insulating	486 - 487
T-TYPE / W IP66 insulating	492
HYGIENIC T-TYPE / H IP66/IP69	504
HYGIENIC T-TYPE / C IP66/IP69, -50 °C	509
W-TYPE for aggressive environments	524
E-Xtreme® corrosion proof	536, 545
EMC	581
Central lever	612
LS-TYPE	624

\*) only bulkhead mounted housings and BIG hoods

- can be mated with CNE, CCE, CSS, CSH inserts  
- inserts may be fitted from front of enclosure

**terminal block inserts  
screw terminal connection**

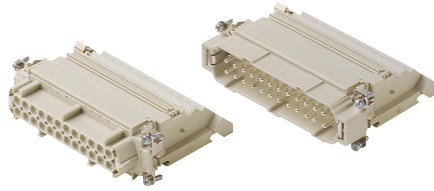

**Q SILVER PLATED CONTACTS**

**terminal block inserts  
spring terminal connection**

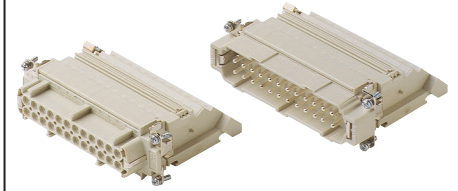

**Q SILVER PLATED CONTACTS**

description	part No.	part No.	part No.	part No.
side mounting (see page 159) female inserts with female contacts <sup>1)</sup> male inserts with male contacts <sup>1)</sup>	left <b>CTF 24 L</b> <b>CTM 24 L</b>	right <b>CTF 24 R</b> <b>CTM 24 R</b>	left <b>CTSEF 24 L</b> <b>CTSEM 24 L</b>	right <b>CTSEF 24 R</b> <b>CTSEM 24 R</b>

1) for non-prepared conductors

- characteristics according to EN 61984:  
**16A 230/400V 4kV 3 (CT)**  
**16A 400V 4kV 2 (CT)**  
**16A 500V 6kV 3 (CTSE)**  
**16A 400/690V 6kV 2 (CTSE)**



- (CT) certified
- (CTSE) certified
- rated voltage according to UL/CSA: 600V
- insulation resistance: ≥ 10 GΩ
- ambient temperature limit: -40 °C ... +125 °C
- made of self-extinguishing thermoplastic resin UL 94V-0
- mechanical life: ≥ 500 cycles
- contact resistance: ≤ 4 mΩ
- for max. current load see the connector inserts derating diagrams below; for more information see page 28

**CT 24 poles connector inserts  
Maximum current load derating diagram**

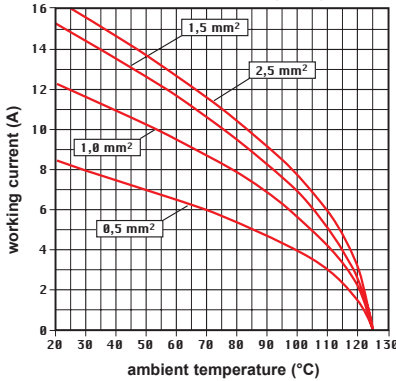

**CTSE 24 poles connector inserts  
Maximum current load derating diagram**

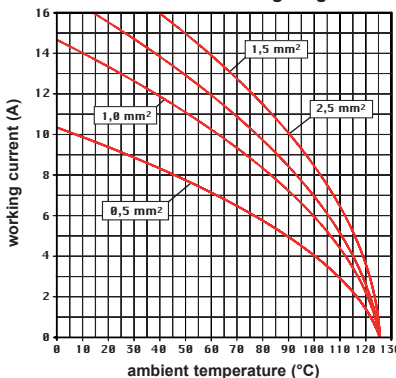

**female inserts (CTF and CTSEF)**

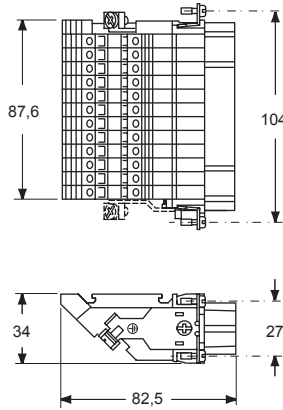

**contacts side (front view)  
female inserts (CTF and CTSEF)**

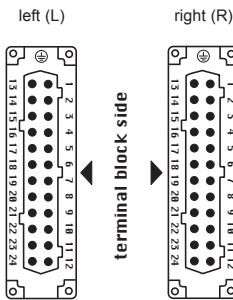

- CT inserts with plate, for section conductors: 0,75 - 2,5 mm² - AWG 18 - 14
- conductors stripping length: 12 mm
- terminal screw torque: 0,4 Nm (3,54 lb.in), for more information see page 20 and 21

**male inserts (CTM and CTSEM)**

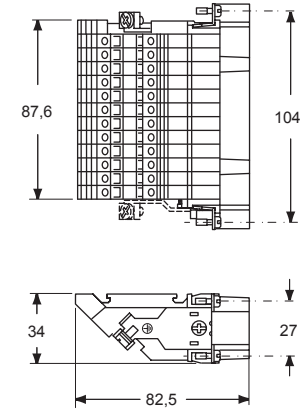

**male inserts (CTM and CTSEM)  
left (L) right (R)**

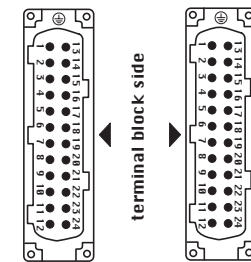

- CTSE spring inserts for section conductors: 0,14 - 2,5 mm² - AWG 26 - 14
- conductors stripping length: 9...11 mm



# CTSE 32 poles + ⊕ 16A - 500V

enclosures \*):  
size "77.62"

page:

C-TYPE IP65/IP66  
W-TYPE for aggressive environments  
E-Xtreme® corrosion proof

424  
525  
546

\*) only bulkhead mounted housings

## terminal block inserts spring terminal connection

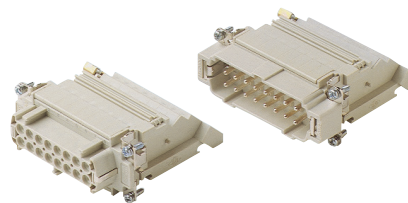

## Q SILVER PLATED CONTACTS

description	part No.	part No.	part No.	part No.
side mounting (see page 159)	left	right	left	right
female inserts with female contacts, No. (1-16) and (17-32) <sup>1)</sup>	<b>CTSEF 16 LN</b>	<b>CTSEF 16 R</b>	<b>CTSEF 16 L</b>	<b>CTSEF 16 RN</b>
male inserts with male contacts, No. (1-16) and (17-32) <sup>1)</sup>	<b>CTSEM 16 LN</b>	<b>CTSEM 16 R</b>	<b>CTSEM 16 L</b>	<b>CTSEM 16 RN</b>

1) for non-prepared conductors

- characteristics according to EN 61984:

**16A 500V 6kV 3**  
**16A 400/690V 6kV 2**

- certified

- rated voltage according to UL/CSA: 600V

- insulation resistance: ≥ 10 GΩ

- ambient temperature limit: -40 °C ... +125 °C

- made of self-extinguishing thermoplastic resin UL 94V-0

- mechanical life: ≥ 500 cycles

- contact resistance: ≤ 4 mΩ

- for max. current load see the connector inserts derating diagram below; for more information see page 28

### female inserts (CTSEF)

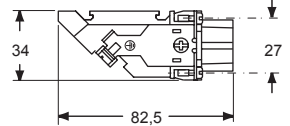
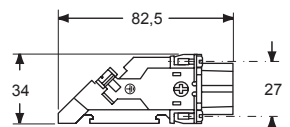
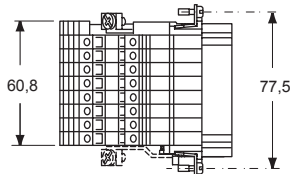

### male inserts (CTSEM)

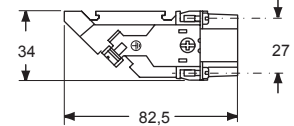
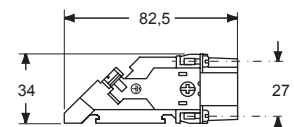
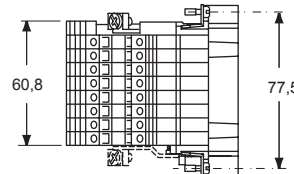

### contacts side (front view)

#### female inserts (CTSEF)

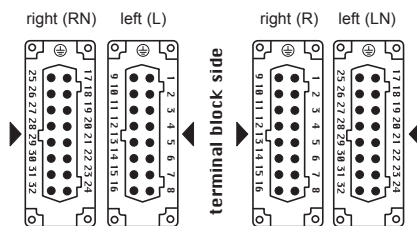

#### male inserts (CTSEM)

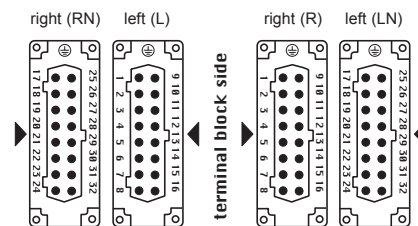

CTSE 32 poles connector inserts  
Maximum current load derating diagram

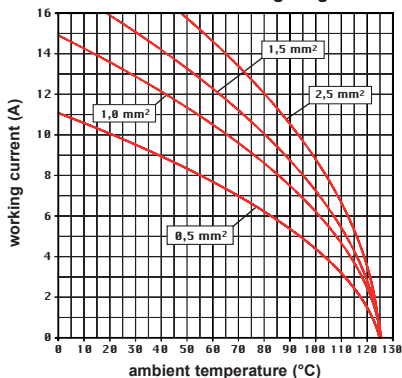

- CTSE spring inserts for section conductors: 0,14 - 2,5 mm<sup>2</sup> - AWG 26 - 14  
- conductors stripping length: 9...11 mm



# CTSE 48 poles + ⊕ 16A - 500V

enclosures \*):  
size "104.62"

page:

C-TYPE IP65/IP66  
W-TYPE for aggressive environments  
E-Xtreme® corrosion proof

430  
526  
547

\*) only bulkhead mounted housings

terminal block inserts  
spring terminal connection

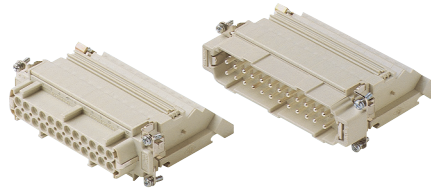

**Q SILVER PLATED CONTACTS**

description	part No.	part No.	part No.	part No.
side mounting (see page 159)	left	right	left	right
female inserts with female contacts, No. (1-24) and (25-48) <sup>1)</sup>	<b>CTSEF 24 LN</b>	<b>CTSEF 24 R</b>	<b>CTSEF 24 L</b>	<b>CTSEF 24 RN</b>
male inserts with male contacts, No. (1-24) and (25-48) <sup>1)</sup>	<b>CTSEM 24 LN</b>	<b>CTSEM 24 R</b>	<b>CTSEM 24 L</b>	<b>CTSEM 24 RN</b>

1) for non-prepared conductors

- characteristics according to EN 61984:

**16A 500V 6kV 3**  
**16A 400/690V 6kV 2**

- certified

- rated voltage according to UL/CSA: 600V

- insulation resistance:  $\geq 10 \text{ G}\Omega$

- ambient temperature limit:  $-40 \text{ }^\circ\text{C} \dots +125 \text{ }^\circ\text{C}$

- made of self-extinguishing thermoplastic resin UL 94V-0

- mechanical life:  $\geq 500$  cycles

- contact resistance:  $\leq 4 \text{ m}\Omega$

- for max. current load see the connector inserts derating diagram below; for more information see page 28

female inserts (CTSEF)

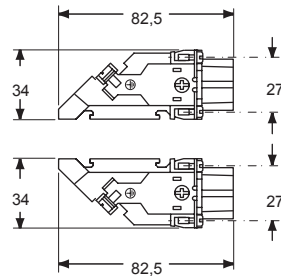
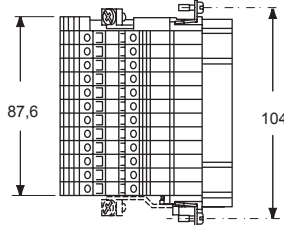

contacts side (front view)

female inserts (CTSEF)

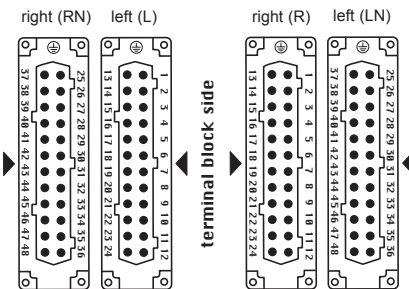

male inserts (CTSEM)

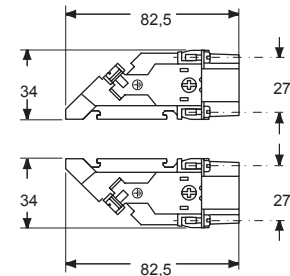
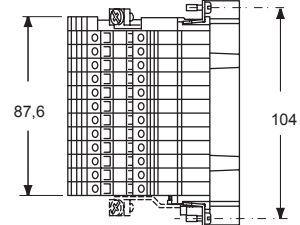

male inserts (CTSEM)

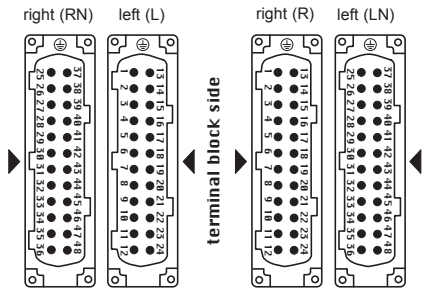

CTSE 48 poles connector inserts  
Maximum current load derating diagram

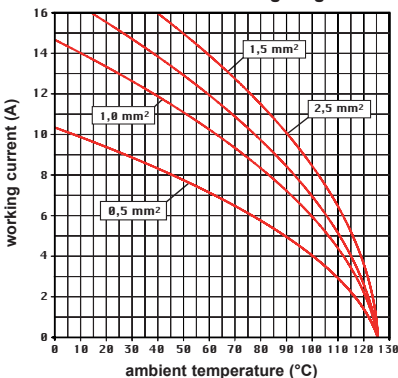

- CTSE spring inserts for section conductors: 0,14 - 2,5 mm<sup>2</sup> - AWG 26 - 14  
- conductors stripping length: 9...11 mm

## CQE series

### TECHNICAL FEATURES

CQE connector inserts are designed for removable crimp contacts series **CC** (solid pin  $\varnothing$  2,5 mm), (including male pins **CC x.x AN** for advanced opening) with rated current up to **16A** per pole, and are the "high density" evolution of historic series **CCE**: in the same housing sizes, the number of pole (contact density) is increased as shown in this table:

Size	series CCE # of poles	series CQE # of poles	density increase
44.27	6 + ⊕	10 + ⊕	1,67
57.27	10 + ⊕	18 + ⊕	1,80
77.27	16 + ⊕	32 + ⊕	2,00
104.27	24 + ⊕	46 + ⊕	1,92
77.62	32 + ⊕ (2x16)	64 + ⊕ (2x32)	2,00
104.62	48 + ⊕ (2x24)	92 + ⊕ (2x46)	1,92

NOTE - The contact density is almost doubled in the same footprint by doubling the number of rows of contacts from 2 to 4. Except for size 77.27, which shows 4 rows of contacts seats equally dimensioned, central rows - due to space constraints to keep the required insulating distances towards the PE lateral contacts - are limited in number to one contact seat less than the peripheral rows.

This allows using the same size of connector housing for wiring almost twice the amount of circuits, or conversely to step down by one size the dimension of the connector housing to wire the same number of circuits, with cost and space efficiency. The only precaution is to suitably select the size of cable entry in case of increase of number of individual wires or diameter of a multi-core cable. Contact retention is operated by the retainers incorporated in the insulating body contact holder. Suitable removal tool **CQES**.

Inserts series		CQE
No. of poles <sup>1)</sup>	main contacts + ⊕	<b>10, 18, 32, 46, (64 = 2x32), (92 = 2x46)</b>
	auxiliary contacts	--
rated current <sup>2)</sup>		16A
EN IEC 61984 pollution degree 3	rated voltage	500V
	rated impulse voltage	6kV
	pollution degree	3
EN IEC 61984 pollution degree 2	rated voltage	830V
	rated impulse voltage	8kV
	pollution degree	2
UL/CSA certification	rated voltage AC/DC	600V
contact resistance		≤ 1 mΩ
insulation resistance		≥ 10 GΩ
ambient temperature limit (°C)	min	-40 °C
	max	+125 °C
degree of protection	with enclosures	<b>IP65, IP66/IP69, IP66/IP67/IP69, IP66/IP68/IP69</b> (according to type and model)
	without enclosures - termination side on male and female inserts; - mating side on female inserts	<b>IP20</b> (IPXXB)
conductor connections		crimp (⊕ only: screw)
conductor cross-sectional area	mm <sup>2</sup>	0,14 - 2,5
	AWG	26 - 12
mechanical endurance (mating cycles)		≥ 500

1) Polarities shown in brackets may be obtained by using two inserts in their own double-sized housings

2) Please check the inserts derating diagrams to establish the actual maximum operating current according to the ambient temperature, the conductor cross-sectional area, the polarity of the connector, and any external constraint that may derive e.g. by the continuous operating temperature sustained by the chosen conductor sheathing or by end-product safety standards fixing max allowed temperature rise on terminals (e.g. 30 K, 45 K or 50 K)

When all the contacts are used, CQE connector inserts may be used at rated voltage up to 500V (first column) pollution degree 3, in accordance with the standard EN 61984. If the number of contacts is reduced and the contacts accordingly assigned, these connectors may be used at higher voltages. This is possible because the decrease in the number of contacts leads to an increase clearances and creepage distances.

When the contacts are arranged as shown below, the inserts may be used at rated voltages of 690V (second column) and 1000V (third column) pollution degree 3, in accordance with the standard EN 61984.

### Special voltages for CQE inserts

**For use up to 500V  
pollution degree 3**

diagrams  
contacts side (front view)

**CQE 10 - 10 + ⊕**

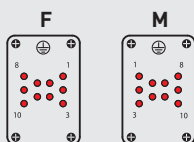

**CQE 18 - 18 + ⊕**

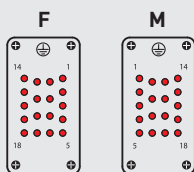

**CQE 32 - 32 + ⊕**

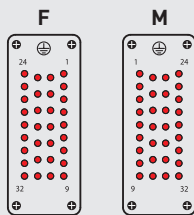

**CQE 46 - 46 + ⊕**

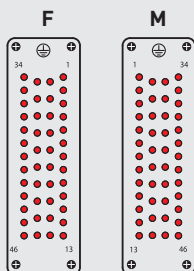

**For use up to 690V  
pollution degree 3**

diagrams  
contacts side (front view)

**CQE 10 - 4 + ⊕**

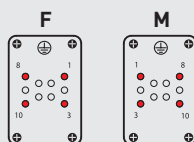

**CQE 18 - 8 + ⊕**

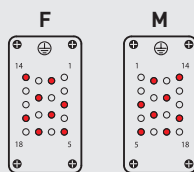

**CQE 32 - 14 + ⊕**

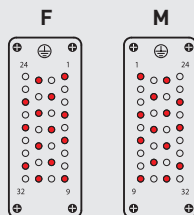

**CQE 46 - 20 + ⊕**

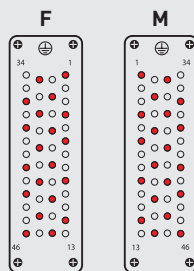

**For use up to 1000V  
pollution degree 3**

diagrams  
contacts side (front view)

**CQE 10 - 2 + ⊕**

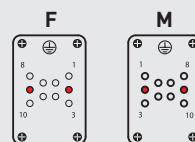

**CQE 18 - 4 + ⊕**

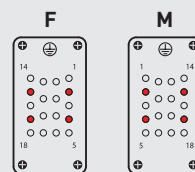

**CQE 32 - 8 + ⊕**

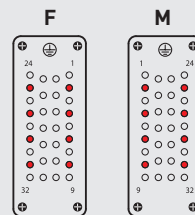

**CQE 46 - 12 + ⊕**

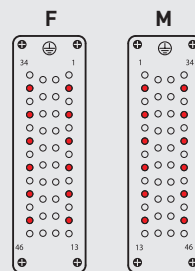

**Legend:**

- working contact
- without contact
- M = male insert
- F = female insert

# CQE 10 poles + ⊕ 16A - 500V

enclosures: size "44.27"	page:
C-TYPE IP65/IP66	387 - 392
C7 IP67, single lever	436 - 437
V-TYPE IP65/IP66, single lever	444 - 447
BIG hoods	466 - 467
T-TYPE IP65 insulating	480 - 481
T-TYPE / W IP66 insulating	489
HYGIENIC T-TYPE / H IP66/IP69	501
HYGIENIC T-TYPE / C IP66/IP69, -50 °C	506
W-TYPE for aggressive environments	521
E-Xtreme® corrosion proof	530 - 531, 542, 550 - 551
EMC	578
Central lever	603 - 605
LS-TYPE	618 - 619
IP68	632 - 635

panel supports:	page:
COB	652 - 653

- for applications requiring higher voltages, please see the special voltage application section on page 167

## inserts, crimp connections

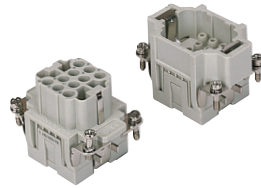

## 16A crimp contacts standard or for advanced opening silver and gold plated



STANDARD

ADVANCED OPENING

description	part No.	part No.
without contacts (to be ordered separately)		
female inserts for female contacts	<b>CQEF 10</b>	
male inserts for male contacts	<b>CQEM 10</b>	
16A female contacts		
0,14-0,37 mm <sup>2</sup> AWG 26-22 one groove	<b>CCFA 0.3</b>	<b>CCFD 0.3</b>
0,5 mm <sup>2</sup> AWG 20 with no grooves	<b>CCFA 0.5</b>	<b>CCFD 0.5</b>
0,75 mm <sup>2</sup> AWG 18 one groove (back side)	<b>CCFA 0.7</b>	<b>CCFD 0.7</b>
1 mm <sup>2</sup> AWG 18 one groove	<b>CCFA 1.0</b>	<b>CCFD 1.0</b>
1,5 mm <sup>2</sup> AWG 16 two grooves	<b>CCFA 1.5</b>	<b>CCFD 1.5</b>
2,5 mm <sup>2</sup> AWG 14 three grooves	<b>CCFA 2.5</b>	<b>CCFD 2.5</b>
3 mm <sup>2</sup> AWG 12 one wide groove	<b>CCFA 3.0</b>	<b>CCFD 3.0</b>
4 mm <sup>2</sup> AWG 12 with no grooves	<b>CCFA 4.0</b>	<b>CCFD 4.0</b>
16A male contacts		
0,14-0,37 mm <sup>2</sup> AWG 26-22 one groove	<b>CCMA 0.3</b>	<b>CCMD 0.3</b>
0,5 mm <sup>2</sup> AWG 20 with no grooves	<b>CCMA 0.5</b>	<b>CCMD 0.5</b>
0,75 mm <sup>2</sup> AWG 18 one groove (back side)	<b>CCMA 0.7</b>	<b>CCMD 0.7</b>
1 mm <sup>2</sup> AWG 18 one groove	<b>CCMA 1.0</b>	<b>CCMD 1.0</b>
1,5 mm <sup>2</sup> AWG 16t wo grooves	<b>CCMA 1.5</b>	<b>CCMD 1.5</b>
2,5 mm <sup>2</sup> AWG 14 three grooves	<b>CCMA 2.5</b>	<b>CCMD 2.5</b>
3 mm <sup>2</sup> AWG 12 one wide groove	<b>CCMA 3.0</b>	<b>CCMD 3.0</b>
4 mm <sup>2</sup> AWG 12 with no grooves	<b>CCMA 4.0</b>	<b>CCMD 4.0</b>
16A male crimp contacts for advanced opening		
0,5 mm <sup>2</sup> AWG 20 with no grooves	<b>CC 0.5 AN</b>	* for basic or high thickness gold plating, please refer to page 675
0,75 mm <sup>2</sup> AWG 18 one groove (back side)	<b>CC 0.7 AN</b>	
1 mm <sup>2</sup> AWG 18 one groove	<b>CC 1.0 AN</b>	
1,5 mm <sup>2</sup> AWG 16 two grooves	<b>CC 1.5 AN</b>	
2,5 mm <sup>2</sup> AWG 14 three grooves	<b>CC 2.5 AN</b>	

- characteristics according to EN 61984:

**16A 500V 6kV 3**  
**16A 830V 8kV 2**

- cULus (UL for USA and Canada),

certified

- rated voltage according to UL/CSA: 600V
- insulation resistance: ≥ 10 GΩ
- ambient temperature limit: -40 °C ... +125 °C
- made of self-extinguishing thermoplastic resin UL 94V-0
- mechanical life: ≥ 500 cycles
- contact resistance: ≤ 1 mΩ
- for max. current load see the connector inserts derating diagram below; for more information see page 28

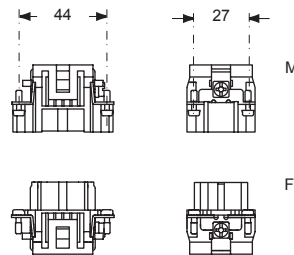

contacts side (front view)

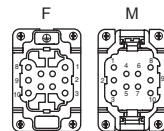

CR CPQ coding pins (page 689)



## CCF and CCM

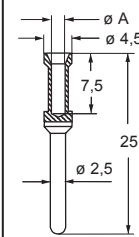

## CC...AN

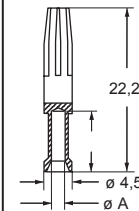
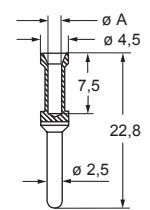

- it is recommended to crimp the contacts with crimping tools homologated by ILME (please see the crimping tool section 16A contacts, CCF, CCM and CC...AN series on pages 705 - 741)

## CCF, CCM and CC...AN contacts

conductor section mm <sup>2</sup>	conductor slot ø A (mm)	conductors stripping length (mm)
0,14-0,37	0,9	7,5
0,5	1,1	7,5
0,75	1,3	7,5
1,0	1,45	7,5
1,5	1,8	7,5
2,5	2,2	7,5
3	2,55	7,5
4	2,85	7,5

CQE 10 poles connector inserts  
Maximum current load derating diagram

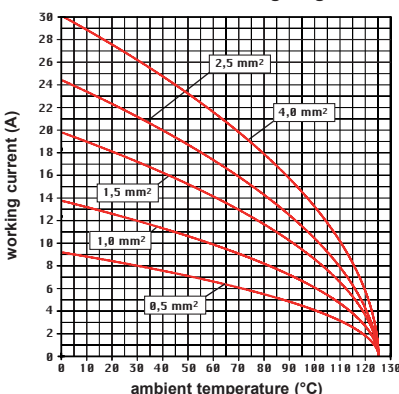

# CQE 18 poles + ⊕ 16A - 500V

enclosures: size "57.27"	page:
C-TYPE IP65/IP66	393 - 401
C7 IP67, two levers	438
V-TYPE IP65/IP66, single lever	448 - 453
BIG hoods	468 - 469
T-TYPE IP65 insulating	482 - 483
T-TYPE / W IP66 insulating	490
HYGIENIC T-TYPE / H IP66/IP69	502
HYGIENIC T-TYPE / C IP66/IP69, -50 °C	507
W-TYPE for aggressive environments	522
E-Xtreme® corrosion proof	532 - 533, 543, 552 - 553
EMC	579
Central lever	606 - 608
LS-TYPE	620 - 621
IP68	636 - 639

panel supports:	page:
COB	652 - 653

- for applications requiring higher voltages, please see the special voltage application section on page 167

## inserts, crimp connections

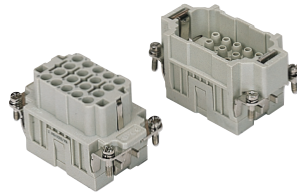

## 16A crimp contacts standard or for advanced opening silver and gold plated



STANDARD



ADVANCED OPENING

description	part No.	part No.
without contacts (to be ordered separately)		
female inserts for female contacts	<b>CQEF 18</b>	
male inserts for male contacts	<b>CQEM 18</b>	
<b>16A female contacts</b>		
0,14-0,37 mm <sup>2</sup> AWG 26-22 one groove	<b>CCFA 0.3</b>	<b>CCFD 0.3</b>
0,5 mm <sup>2</sup> AWG 20 with no grooves	<b>CCFA 0.5</b>	<b>CCFD 0.5</b>
0,75 mm <sup>2</sup> AWG 18 one groove (back side)	<b>CCFA 0.7</b>	<b>CCFD 0.7</b>
1 mm <sup>2</sup> AWG 18 one groove	<b>CCFA 1.0</b>	<b>CCFD 1.0</b>
1,5 mm <sup>2</sup> AWG 16 two grooves	<b>CCFA 1.5</b>	<b>CCFD 1.5</b>
2,5 mm <sup>2</sup> AWG 14 three grooves	<b>CCFA 2.5</b>	<b>CCFD 2.5</b>
3 mm <sup>2</sup> AWG 12 one wide groove	<b>CCFA 3.0</b>	<b>CCFD 3.0</b>
4 mm <sup>2</sup> AWG 12 with no grooves	<b>CCFA 4.0</b>	<b>CCFD 4.0</b>
<b>16A male contacts</b>		
0,14-0,37 mm <sup>2</sup> AWG 26-22 one groove	<b>CCMA 0.3</b>	<b>CCMD 0.3</b>
0,5 mm <sup>2</sup> AWG 20 with no grooves	<b>CCMA 0.5</b>	<b>CCMD 0.5</b>
0,75 mm <sup>2</sup> AWG 18 one groove (back side)	<b>CCMA 0.7</b>	<b>CCMD 0.7</b>
1 mm <sup>2</sup> AWG 18 one groove	<b>CCMA 1.0</b>	<b>CCMD 1.0</b>
1,5 mm <sup>2</sup> AWG 16t wo grooves	<b>CCMA 1.5</b>	<b>CCMD 1.5</b>
2,5 mm <sup>2</sup> AWG 14 three grooves	<b>CCMA 2.5</b>	<b>CCMD 2.5</b>
3 mm <sup>2</sup> AWG 12 one wide groove	<b>CCMA 3.0</b>	<b>CCMD 3.0</b>
4 mm <sup>2</sup> AWG 12 with no grooves	<b>CCMA 4.0</b>	<b>CCMD 4.0</b>
<b>16A male crimp contacts for advanced opening</b>		
0,5 mm <sup>2</sup> AWG 20 with no grooves	<b>CC 0.5 AN</b>	+ for basic or high thickness gold plating, please refer to page 675
0,75 mm <sup>2</sup> AWG 18 one groove (back side)	<b>CC 0.7 AN</b>	
1 mm <sup>2</sup> AWG 18 one groove	<b>CC 1.0 AN</b>	
1,5 mm <sup>2</sup> AWG 16 two grooves	<b>CC 1.5 AN</b>	
2,5 mm <sup>2</sup> AWG 14 three grooves	<b>CC 2.5 AN</b>	

- characteristics according to EN 61984:

**16A 500V 6kV 3**  
**16A 830V 8kV 2**

- cULus (UL for USA and Canada),

- certified

- rated voltage according to UL/CSA: 600V
- insulation resistance: ≥ 10 GΩ
- ambient temperature limit: -40 °C ... +125 °C
- made of self-extinguishing thermoplastic resin UL 94V-0
- mechanical life: ≥ 500 cycles
- contact resistance: ≤ 1 mΩ
- for max. current load see the connector inserts derating diagram below; for more information see page 28

**CQE 18 poles connector inserts**  
**Maximum current load derating diagram**

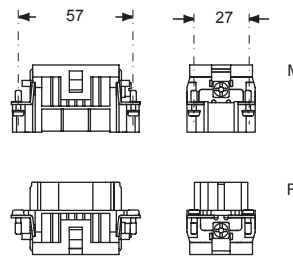
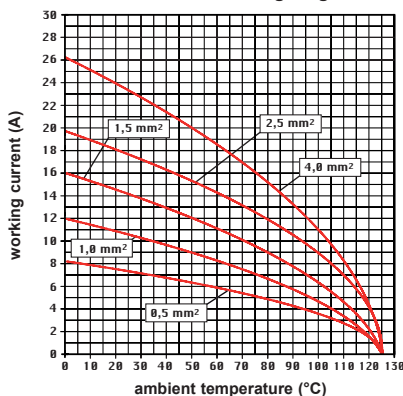

contacts side (front view)

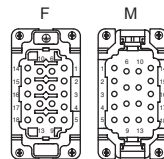

CR CPQ coding pins (page 689)



### CCF and CCM

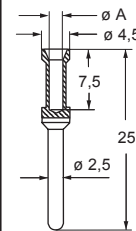

### CC...AN

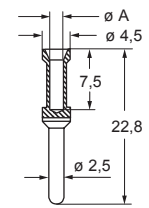

- it is recommended to crimp the contacts with crimping tools homologated by ILME (please see the crimping tool section 16A contacts, CCF, CCM and CC...AN series on pages 705 - 741)

### CCF, CCM and CC...AN contacts

conductor section mm <sup>2</sup>	conductor slot Ø A (mm)	conductors stripping length (mm)
0,14-0,37	0,9	7,5
0,5	1,1	7,5
0,75	1,3	7,5
1,0	1,45	7,5
1,5	1,8	7,5
2,5	2,2	7,5
3	2,55	7,5
4	2,85	7,5

# CQE 32 poles + ⊕ 16A - 500V

enclosures: size "77.27"	page:
C-TYPE IP65/IP66	402 - 411
C7 IP67, two levers	439 - 440
V-TYPE IP65/IP66, single lever	454 - 458
BIG hoods	470 - 471
T-TYPE IP65 insulating	484 - 485
T-TYPE / W IP66 insulating	491
HYGIENIC T-TYPE / H IP66/IP69	503
HYGIENIC T-TYPE / C IP66/IP69, -50 °C	508
W-TYPE for aggressive environments	523
E-Xtreme® corrosion proof	534 - 535, 544, 554 - 555
EMC	580
Central lever	609 - 611
LS-TYPE	622 - 623
IP68	640 - 643

panel supports:	page:
COB	652 - 653

- for applications requiring higher voltages, please see the special voltage application section on page 167

## inserts, crimp connections

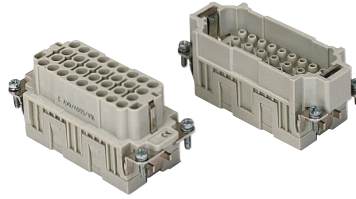

## 16A crimp contacts standard or for advanced opening silver and gold plated



STANDARD



ADVANCED OPENING

description	part No.	part No.
without contacts (to be ordered separately)		
female inserts for female contacts	<b>CQEF 32</b>	
male inserts for male contacts	<b>CQEM 32</b>	
16A female contacts		
0,14-0,37 mm <sup>2</sup> AWG 26-22 one groove	<b>CCFA 0.3</b>	<b>CCFD 0.3</b>
0,5 mm <sup>2</sup> AWG 20 with no grooves	<b>CCFA 0.5</b>	<b>CCFD 0.5</b>
0,75 mm <sup>2</sup> AWG 18 one groove (back side)	<b>CCFA 0.7</b>	<b>CCFD 0.7</b>
1 mm <sup>2</sup> AWG 18 one groove	<b>CCFA 1.0</b>	<b>CCFD 1.0</b>
1,5 mm <sup>2</sup> AWG 16 two grooves	<b>CCFA 1.5</b>	<b>CCFD 1.5</b>
2,5 mm <sup>2</sup> AWG 14 three grooves	<b>CCFA 2.5</b>	<b>CCFD 2.5</b>
3 mm <sup>2</sup> AWG 12 one wide groove	<b>CCFA 3.0</b>	<b>CCFD 3.0</b>
4 mm <sup>2</sup> AWG 12 with no grooves	<b>CCFA 4.0</b>	<b>CCFD 4.0</b>
16A male contacts		
0,14-0,37 mm <sup>2</sup> AWG 26-22 one groove	<b>CCMA 0.3</b>	<b>CCMD 0.3</b>
0,5 mm <sup>2</sup> AWG 20 with no grooves	<b>CCMA 0.5</b>	<b>CCMD 0.5</b>
0,75 mm <sup>2</sup> AWG 18 one groove (back side)	<b>CCMA 0.7</b>	<b>CCMD 0.7</b>
1 mm <sup>2</sup> AWG 18 one groove	<b>CCMA 1.0</b>	<b>CCMD 1.0</b>
1,5 mm <sup>2</sup> AWG 16t wo grooves	<b>CCMA 1.5</b>	<b>CCMD 1.5</b>
2,5 mm <sup>2</sup> AWG 14 three grooves	<b>CCMA 2.5</b>	<b>CCMD 2.5</b>
3 mm <sup>2</sup> AWG 12 one wide groove	<b>CCMA 3.0</b>	<b>CCMD 3.0</b>
4 mm <sup>2</sup> AWG 12 with no grooves	<b>CCMA 4.0</b>	<b>CCMD 4.0</b>
16A male crimp contacts for advanced opening		
0,5 mm <sup>2</sup> AWG 20 with no grooves	<b>CC 0.5 AN</b>	* for basic or high thickness gold plating, please refer to page 675
0,75 mm <sup>2</sup> AWG 18 one groove (back side)	<b>CC 0.7 AN</b>	
1 mm <sup>2</sup> AWG 18 one groove	<b>CC 1.0 AN</b>	
1,5 mm <sup>2</sup> AWG 16 two grooves	<b>CC 1.5 AN</b>	
2,5 mm <sup>2</sup> AWG 14 three grooves	<b>CC 2.5 AN</b>	

- characteristics according to EN 61984:

**16A 500V 6kV 3**  
**16A 830V 8kV 2**

- cULus (UL for USA and Canada),

certified

- rated voltage according to UL/CSA: 600V
- insulation resistance: ≥ 10 GΩ
- ambient temperature limit: -40 °C ... +125 °C
- made of self-extinguishing thermoplastic resin UL 94V-0
- mechanical life: ≥ 500 cycles
- contact resistance: ≤ 1 mΩ
- for max. current load see the connector inserts derating diagram below; for more information see page 28

**CQE 32 poles connector inserts**  
**Maximum current load derating diagram**

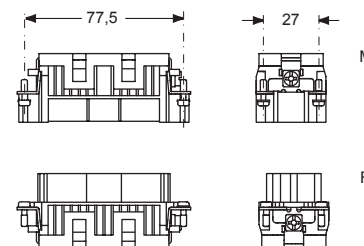
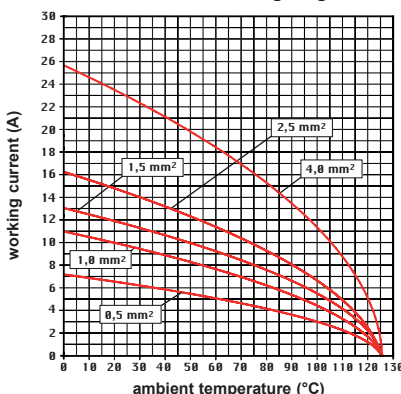

contacts side (front view)

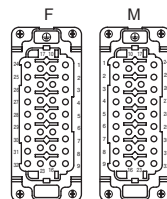

CR CPQ coding pins (page 689)



### CCF and CCM

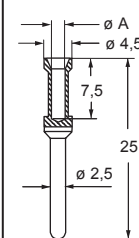

### CC...AN

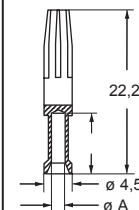
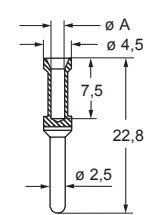

- it is recommended to crimp the contacts with crimping tools homologated by ILME (please see the crimping tool section 16A contacts, CCF, CCM and CC...AN series on pages 705 - 741)

### CCF, CCM and CC...AN contacts

conductor section mm <sup>2</sup>	conductor slot ø A (mm)	stripping length (mm)
0,14-0,37	0,9	7,5
0,5	1,1	7,5
0,75	1,3	7,5
1,0	1,45	7,5
1,5	1,8	7,5
2,5	2,2	7,5
3	2,55	7,5
4	2,85	7,5



# CQE 46 poles + ⊕ 16A - 500V

enclosures: size "104.27"	page:
C-TYPE IP65/IP66	412 - 423
C7 IP67, two levers	441 - 442
V-TYPE IP65/IP66, single lever	459 - 463
BIG hoods	472 - 473
T-TYPE IP65 insulating	486 - 487
T-TYPE / W IP66 insulating	492
HYGIENIC T-TYPE / H IP66/IP69	504
HYGIENIC T-TYPE / C IP66/IP69, -50 °C	509
W-TYPE for aggressive environments	524
E-Xtreme® corrosion proof	536 - 537, 545, 556 - 557
EMC	581
Central lever	612 - 614
LS-TYPE	624 - 625
IP68	644 - 647
panel supports: COB	page: 652 - 653

## inserts, crimp connections

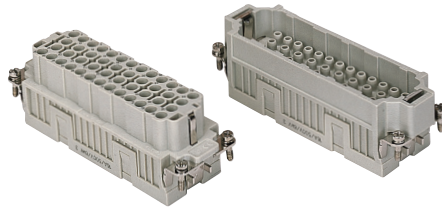

## 16A crimp contacts standard or for advanced opening silver and gold plated

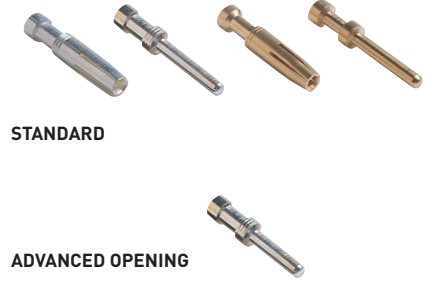

- for applications requiring higher voltages, please see the special voltage application section on page 167

description	part No.	part No.
-------------	----------	----------

without contacts (to be ordered separately)  
female inserts for female contacts **CQEF 46**  
male inserts for male contacts **CQEM 46**

<p>16A female contacts</p> <table border="0"> <tr><td>0,14-0,37 mm<sup>2</sup></td><td>AWG 26-22</td><td>one groove</td></tr> <tr><td>0,5 mm<sup>2</sup></td><td>AWG 20</td><td>with no grooves</td></tr> <tr><td>0,75 mm<sup>2</sup></td><td>AWG 18</td><td>one groove (back side)</td></tr> <tr><td>1 mm<sup>2</sup></td><td>AWG 18</td><td>one groove</td></tr> <tr><td>1,5 mm<sup>2</sup></td><td>AWG 16</td><td>two grooves</td></tr> <tr><td>2,5 mm<sup>2</sup></td><td>AWG 14</td><td>three grooves</td></tr> <tr><td>3 mm<sup>2</sup></td><td>AWG 12</td><td>one wide groove</td></tr> <tr><td>4 mm<sup>2</sup></td><td>AWG 12</td><td>with no grooves</td></tr> </table> <p>16A male contacts</p> <table border="0"> <tr><td>0,14-0,37 mm<sup>2</sup></td><td>AWG 26-22</td><td>one groove</td></tr> <tr><td>0,5 mm<sup>2</sup></td><td>AWG 20</td><td>with no grooves</td></tr> <tr><td>0,75 mm<sup>2</sup></td><td>AWG 18</td><td>one groove (back side)</td></tr> <tr><td>1 mm<sup>2</sup></td><td>AWG 18</td><td>one groove</td></tr> <tr><td>1,5 mm<sup>2</sup></td><td>AWG 16t</td><td>wo grooves</td></tr> <tr><td>2,5 mm<sup>2</sup></td><td>AWG 14</td><td>three grooves</td></tr> <tr><td>3 mm<sup>2</sup></td><td>AWG 12</td><td>one wide groove</td></tr> <tr><td>4 mm<sup>2</sup></td><td>AWG 12</td><td>with no grooves</td></tr> </table> <p>16A male crimp contacts for advanced opening</p> <table border="0"> <tr><td>0,5 mm<sup>2</sup></td><td>AWG 20</td><td>with no grooves</td></tr> <tr><td>0,75 mm<sup>2</sup></td><td>AWG 18</td><td>one groove (back side)</td></tr> <tr><td>1 mm<sup>2</sup></td><td>AWG 18</td><td>one groove</td></tr> <tr><td>1,5 mm<sup>2</sup></td><td>AWG 16</td><td>two grooves</td></tr> <tr><td>2,5 mm<sup>2</sup></td><td>AWG 14</td><td>three grooves</td></tr> </table>	0,14-0,37 mm <sup>2</sup>	AWG 26-22	one groove	0,5 mm <sup>2</sup>	AWG 20	with no grooves	0,75 mm <sup>2</sup>	AWG 18	one groove (back side)	1 mm <sup>2</sup>	AWG 18	one groove	1,5 mm <sup>2</sup>	AWG 16	two grooves	2,5 mm <sup>2</sup>	AWG 14	three grooves	3 mm <sup>2</sup>	AWG 12	one wide groove	4 mm <sup>2</sup>	AWG 12	with no grooves	0,14-0,37 mm <sup>2</sup>	AWG 26-22	one groove	0,5 mm <sup>2</sup>	AWG 20	with no grooves	0,75 mm <sup>2</sup>	AWG 18	one groove (back side)	1 mm <sup>2</sup>	AWG 18	one groove	1,5 mm <sup>2</sup>	AWG 16t	wo grooves	2,5 mm <sup>2</sup>	AWG 14	three grooves	3 mm <sup>2</sup>	AWG 12	one wide groove	4 mm <sup>2</sup>	AWG 12	with no grooves	0,5 mm <sup>2</sup>	AWG 20	with no grooves	0,75 mm <sup>2</sup>	AWG 18	one groove (back side)	1 mm <sup>2</sup>	AWG 18	one groove	1,5 mm <sup>2</sup>	AWG 16	two grooves	2,5 mm <sup>2</sup>	AWG 14	three grooves	<p style="writing-mode: vertical-rl; transform: rotate(180deg);">silver plated</p>	<table border="0"> <tr><td><b>CCFA 0.3</b></td><td><b>CCFD 0.3</b></td></tr> <tr><td><b>CCFA 0.5</b></td><td><b>CCFD 0.5</b></td></tr> <tr><td><b>CCFA 0.7</b></td><td><b>CCFD 0.7</b></td></tr> <tr><td><b>CCFA 1.0</b></td><td><b>CCFD 1.0</b></td></tr> <tr><td><b>CCFA 1.5</b></td><td><b>CCFD 1.5</b></td></tr> <tr><td><b>CCFA 2.5</b></td><td><b>CCFD 2.5</b></td></tr> <tr><td><b>CCFA 3.0</b></td><td><b>CCFD 3.0</b></td></tr> <tr><td><b>CCFA 4.0</b></td><td><b>CCFD 4.0</b></td></tr> </table> <table border="0"> <tr><td><b>CCMA 0.3</b></td><td><b>CCMD 0.3</b></td></tr> <tr><td><b>CCMA 0.5</b></td><td><b>CCMD 0.5</b></td></tr> <tr><td><b>CCMA 0.7</b></td><td><b>CCMD 0.7</b></td></tr> <tr><td><b>CCMA 1.0</b></td><td><b>CCMD 1.0</b></td></tr> <tr><td><b>CCMA 1.5</b></td><td><b>CCMD 1.5</b></td></tr> <tr><td><b>CCMA 2.5</b></td><td><b>CCMD 2.5</b></td></tr> <tr><td><b>CCMA 3.0</b></td><td><b>CCMD 3.0</b></td></tr> <tr><td><b>CCMA 4.0</b></td><td><b>CCMD 4.0</b></td></tr> </table>	<b>CCFA 0.3</b>	<b>CCFD 0.3</b>	<b>CCFA 0.5</b>	<b>CCFD 0.5</b>	<b>CCFA 0.7</b>	<b>CCFD 0.7</b>	<b>CCFA 1.0</b>	<b>CCFD 1.0</b>	<b>CCFA 1.5</b>	<b>CCFD 1.5</b>	<b>CCFA 2.5</b>	<b>CCFD 2.5</b>	<b>CCFA 3.0</b>	<b>CCFD 3.0</b>	<b>CCFA 4.0</b>	<b>CCFD 4.0</b>	<b>CCMA 0.3</b>	<b>CCMD 0.3</b>	<b>CCMA 0.5</b>	<b>CCMD 0.5</b>	<b>CCMA 0.7</b>	<b>CCMD 0.7</b>	<b>CCMA 1.0</b>	<b>CCMD 1.0</b>	<b>CCMA 1.5</b>	<b>CCMD 1.5</b>	<b>CCMA 2.5</b>	<b>CCMD 2.5</b>	<b>CCMA 3.0</b>	<b>CCMD 3.0</b>	<b>CCMA 4.0</b>	<b>CCMD 4.0</b>	<p style="writing-mode: vertical-rl; transform: rotate(180deg);">gold plated+*</p>
0,14-0,37 mm <sup>2</sup>	AWG 26-22	one groove																																																																																																
0,5 mm <sup>2</sup>	AWG 20	with no grooves																																																																																																
0,75 mm <sup>2</sup>	AWG 18	one groove (back side)																																																																																																
1 mm <sup>2</sup>	AWG 18	one groove																																																																																																
1,5 mm <sup>2</sup>	AWG 16	two grooves																																																																																																
2,5 mm <sup>2</sup>	AWG 14	three grooves																																																																																																
3 mm <sup>2</sup>	AWG 12	one wide groove																																																																																																
4 mm <sup>2</sup>	AWG 12	with no grooves																																																																																																
0,14-0,37 mm <sup>2</sup>	AWG 26-22	one groove																																																																																																
0,5 mm <sup>2</sup>	AWG 20	with no grooves																																																																																																
0,75 mm <sup>2</sup>	AWG 18	one groove (back side)																																																																																																
1 mm <sup>2</sup>	AWG 18	one groove																																																																																																
1,5 mm <sup>2</sup>	AWG 16t	wo grooves																																																																																																
2,5 mm <sup>2</sup>	AWG 14	three grooves																																																																																																
3 mm <sup>2</sup>	AWG 12	one wide groove																																																																																																
4 mm <sup>2</sup>	AWG 12	with no grooves																																																																																																
0,5 mm <sup>2</sup>	AWG 20	with no grooves																																																																																																
0,75 mm <sup>2</sup>	AWG 18	one groove (back side)																																																																																																
1 mm <sup>2</sup>	AWG 18	one groove																																																																																																
1,5 mm <sup>2</sup>	AWG 16	two grooves																																																																																																
2,5 mm <sup>2</sup>	AWG 14	three grooves																																																																																																
<b>CCFA 0.3</b>	<b>CCFD 0.3</b>																																																																																																	
<b>CCFA 0.5</b>	<b>CCFD 0.5</b>																																																																																																	
<b>CCFA 0.7</b>	<b>CCFD 0.7</b>																																																																																																	
<b>CCFA 1.0</b>	<b>CCFD 1.0</b>																																																																																																	
<b>CCFA 1.5</b>	<b>CCFD 1.5</b>																																																																																																	
<b>CCFA 2.5</b>	<b>CCFD 2.5</b>																																																																																																	
<b>CCFA 3.0</b>	<b>CCFD 3.0</b>																																																																																																	
<b>CCFA 4.0</b>	<b>CCFD 4.0</b>																																																																																																	
<b>CCMA 0.3</b>	<b>CCMD 0.3</b>																																																																																																	
<b>CCMA 0.5</b>	<b>CCMD 0.5</b>																																																																																																	
<b>CCMA 0.7</b>	<b>CCMD 0.7</b>																																																																																																	
<b>CCMA 1.0</b>	<b>CCMD 1.0</b>																																																																																																	
<b>CCMA 1.5</b>	<b>CCMD 1.5</b>																																																																																																	
<b>CCMA 2.5</b>	<b>CCMD 2.5</b>																																																																																																	
<b>CCMA 3.0</b>	<b>CCMD 3.0</b>																																																																																																	
<b>CCMA 4.0</b>	<b>CCMD 4.0</b>																																																																																																	
			<p><b>CC 0.5 AN</b></p> <p><b>CC 0.7 AN</b></p> <p><b>CC 1.0 AN</b></p> <p><b>CC 1.5 AN</b></p> <p><b>CC 2.5 AN</b></p>	<p>* for basic or high thickness gold plating, please refer to page 675</p>																																																																																														

- characteristics according to EN 61984:  
**16A 500V 6kV 3**  
**16A 830V 8kV 2**
- (UL for USA and Canada), certified
- rated voltage according to UL/CSA: 600V
- insulation resistance: ≥ 10 GΩ
- ambient temperature limit: -40 °C ... +125 °C
- made of self-extinguishing thermoplastic resin UL 94V-0
- mechanical life: ≥ 500 cycles
- contact resistance: ≤ 1 mΩ
- for max. current load see the connector inserts derating diagram below; for more information see page 28

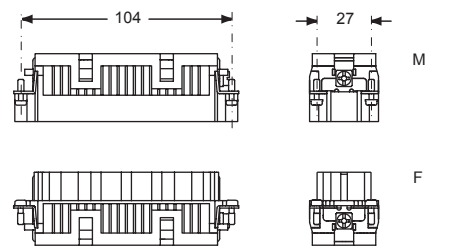
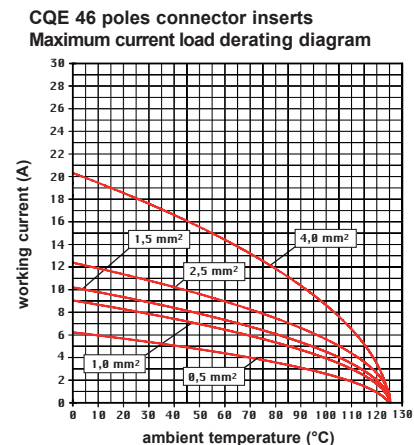

contacts side (front view)

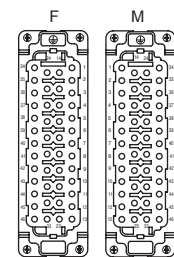

CR CPQ coding pins  
(page 689)

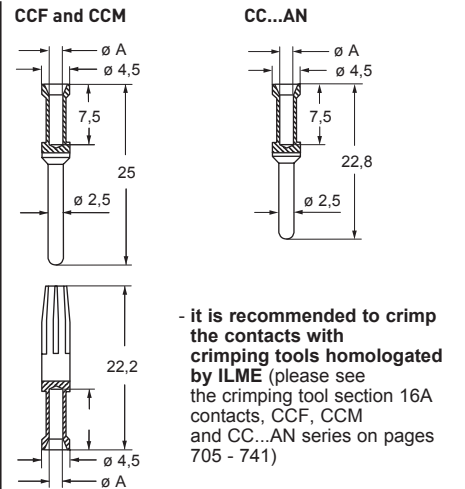

**CCF, CCM and CC...AN contacts**

conductor section mm <sup>2</sup>	conductor slot ø A (mm)	conductors stripping length (mm)
0,14-0,37	0,9	7,5
0,5	1,1	7,5
0,75	1,3	7,5
1,0	1,45	7,5
1,5	1,8	7,5
2,5	2,2	7,5
3	2,55	7,5
4	2,85	7,5

# CQE 64 poles + ⊕ 16A - 500V

enclosures:  
size "77.62"

page:

C-TYPE IP65/IP66  
W-TYPE for aggressive environments  
E-Xtreme® corrosion proof

424 - 429  
525  
546

## inserts, crimp connections

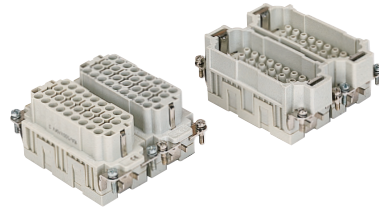

## 16A crimp contacts standard or for advanced opening silver and gold plated



STANDARD



ADVANCED OPENING

- for applications requiring higher voltages, please see the special voltage application section on page 167

description	part No.	part No.	part No.
without contacts (to be ordered separately)			
female inserts for female contacts, No. (1-32) and (33-64)	<b>CQEF 32</b>	<b>CQEF 32 N</b>	
male inserts for male contacts, No. (1-32) and (33-64)	<b>CQEM 32</b>	<b>CQEM 32 N</b>	
16A female contacts			
0,14-0,37 mm <sup>2</sup> AWG 26-22 one groove			<b>CCFA 0.3</b>
0,5 mm <sup>2</sup> AWG 20 with no grooves			<b>CCFA 0.5</b>
0,75 mm <sup>2</sup> AWG 18 one groove (back side)			<b>CCFA 0.7</b>
1 mm <sup>2</sup> AWG 18 one groove			<b>CCFA 1.0</b>
1,5 mm <sup>2</sup> AWG 16 two grooves			<b>CCFA 1.5</b>
2,5 mm <sup>2</sup> AWG 14 three grooves			<b>CCFA 2.5</b>
3 mm <sup>2</sup> AWG 12 one wide groove			<b>CCFA 3.0</b>
4 mm <sup>2</sup> AWG 12 with no grooves			<b>CCFA 4.0</b>
16A male contacts			
0,14-0,37 mm <sup>2</sup> AWG 26-22 one groove			<b>CCMA 0.3</b>
0,5 mm <sup>2</sup> AWG 20 with no grooves			<b>CCMA 0.5</b>
0,75 mm <sup>2</sup> AWG 18 one groove (back side)			<b>CCMA 0.7</b>
1 mm <sup>2</sup> AWG 18 one groove			<b>CCMA 1.0</b>
1,5 mm <sup>2</sup> AWG 16t wo grooves			<b>CCMA 1.5</b>
2,5 mm <sup>2</sup> AWG 14 three grooves			<b>CCMA 2.5</b>
3 mm <sup>2</sup> AWG 12 one wide groove			<b>CCMA 3.0</b>
4 mm <sup>2</sup> AWG 12 with no grooves			<b>CCMA 4.0</b>
16A male crimp contacts for advanced opening			
0,5 mm <sup>2</sup> AWG 20 with no grooves			<b>CC 0.5 AN</b>
0,75 mm <sup>2</sup> AWG 18 one groove (back side)			<b>CC 0.7 AN</b>
1 mm <sup>2</sup> AWG 18 one groove			<b>CC 1.0 AN</b>
1,5 mm <sup>2</sup> AWG 16 two grooves			<b>CC 1.5 AN</b>
2,5 mm <sup>2</sup> AWG 14 three grooves			<b>CC 2.5 AN</b>
			<b>CC 3.0 AN</b>
			<b>CC 4.0 AN</b>

silver plated

gold plated<sup>+</sup>

+ for basic or high thickness gold plating, please refer to page 675

- characteristics according to EN 61984:

**16A 500V 6kV 3**  
**16A 830V 8kV 2**

- cULus (UL for USA and Canada),

certified

- rated voltage according to UL/CSA: 600V
- insulation resistance: ≥ 10 GΩ
- ambient temperature limit: -40 °C ... +125 °C
- made of self-extinguishing thermoplastic resin UL 94V-0
- mechanical life: ≥ 500 cycles
- contact resistance: ≤ 1 mΩ
- for max. current load see the connector inserts derating diagram below; for more information see page 28

**CQE 64 poles connector inserts  
Maximum current load derating diagram**

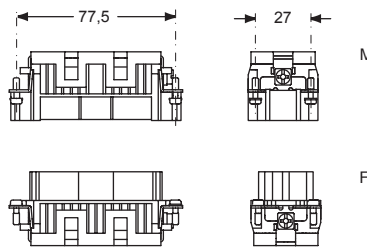
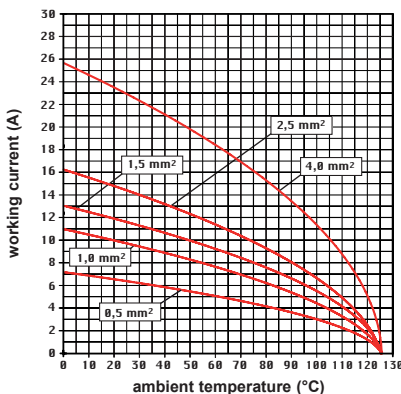

contacts side (front view)

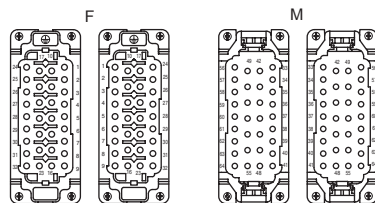

CR CPQ coding pins  
(page 689)



### CCF and CCM

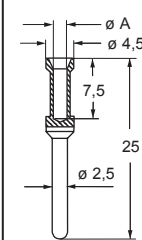

### CC...AN

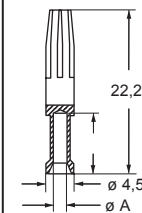
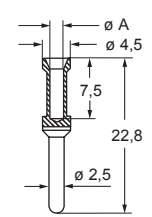

- it is recommended to crimp the contacts with crimping tools homologated by ILME (please see the crimping tool section 16A contacts, CCF, CCM and CC...AN series on pages 705 - 741)

### CCF, CCM and CC...AN contacts

conductor section mm <sup>2</sup>	conductor slot ø A (mm)	conductors stripping length (mm)
0,14-0,37	0,9	7,5
0,5	1,1	7,5
0,75	1,3	7,5
1,0	1,45	7,5
1,5	1,8	7,5
2,5	2,2	7,5
3	2,55	7,5
4	2,85	7,5

# CQE 92 poles + ⊕ 16A - 500V

enclosures:  
size "104.62"

page:

C-TYPE IP65/IP66  
W-TYPE for aggressive environments  
E-Xtreme® corrosion proof

430  
526  
547

## inserts, crimp connections

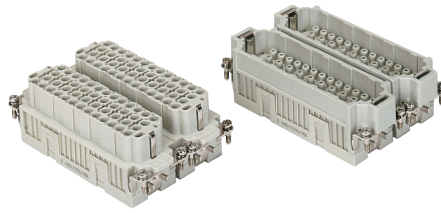

## 16A crimp contacts standard or for advanced opening silver and gold plated

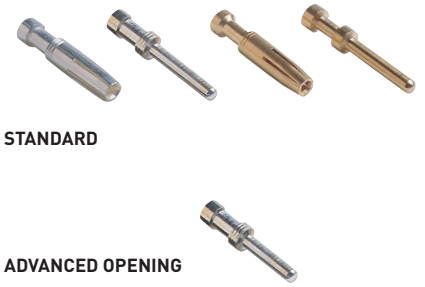

STANDARD

ADVANCED OPENING

- for applications requiring higher voltages, please see the special voltage application section on page 167

description	part No.	part No.	part No.
without contacts (to be ordered separately)			
female inserts for female contacts, No. (1-46) and (47-92)	<b>CQEF 46</b>	<b>CQEF 46 N</b>	
male inserts for male contacts, No. (1-46) and (47-92)	<b>CQEM 46</b>	<b>CQEM 46 N</b>	
<b>16A female contacts</b>			
0,14-0,37 mm <sup>2</sup> AWG 26-22 one groove			<b>CCFA 0.3</b>
0,5 mm <sup>2</sup> AWG 20 with no grooves			<b>CCFA 0.5</b>
0,75 mm <sup>2</sup> AWG 18 one groove (back side)			<b>CCFA 0.7</b>
1 mm <sup>2</sup> AWG 18 one groove			<b>CCFA 1.0</b>
1,5 mm <sup>2</sup> AWG 16 two grooves			<b>CCFA 1.5</b>
2,5 mm <sup>2</sup> AWG 14 three grooves			<b>CCFA 2.5</b>
3 mm <sup>2</sup> AWG 12 one wide groove			<b>CCFA 3.0</b>
4 mm <sup>2</sup> AWG 12 with no grooves			<b>CCFA 4.0</b>
<b>16A male contacts</b>			
0,14-0,37 mm <sup>2</sup> AWG 26-22 one groove			<b>CCMA 0.3</b>
0,5 mm <sup>2</sup> AWG 20 with no grooves			<b>CCMA 0.5</b>
0,75 mm <sup>2</sup> AWG 18 one groove (back side)			<b>CCMA 0.7</b>
1 mm <sup>2</sup> AWG 18 one groove			<b>CCMA 1.0</b>
1,5 mm <sup>2</sup> AWG 16t wo grooves			<b>CCMA 1.5</b>
2,5 mm <sup>2</sup> AWG 14 three grooves			<b>CCMA 2.5</b>
3 mm <sup>2</sup> AWG 12 one wide groove			<b>CCMA 3.0</b>
4 mm <sup>2</sup> AWG 12 with no grooves			<b>CCMA 4.0</b>
<b>16A male crimp contacts for advanced opening</b>			
0,5 mm <sup>2</sup> AWG 20 with no grooves			<b>CC 0.5 AN</b>
0,75 mm <sup>2</sup> AWG 18 one groove (back side)			<b>CC 0.7 AN</b>
1 mm <sup>2</sup> AWG 18 one groove			<b>CC 1.0 AN</b>
1,5 mm <sup>2</sup> AWG 16 two grooves			<b>CC 1.5 AN</b>
2,5 mm <sup>2</sup> AWG 14 three grooves			<b>CC 2.5 AN</b>
			<b>CCFD 0.3</b>
			<b>CCFD 0.5</b>
			<b>CCFD 0.7</b>
			<b>CCFD 1.0</b>
			<b>CCFD 1.5</b>
			<b>CCFD 2.5</b>
			<b>CCFD 3.0</b>
			<b>CCFD 4.0</b>
			<b>CCMD 0.3</b>
			<b>CCMD 0.5</b>
			<b>CCMD 0.7</b>
			<b>CCMD 1.0</b>
			<b>CCMD 1.5</b>
			<b>CCMD 2.5</b>
			<b>CCMD 3.0</b>
			<b>CCMD 4.0</b>

silver plated

gold plated+

+ for basic or high thickness gold plating, please refer to page 675

- characteristics according to EN 61984:

**16A 500V 6kV 3**  
**16A 830V 8kV 2**

- certified

- certified

- rated voltage according to UL/CSA: 600V
- insulation resistance: ≥ 10 GΩ
- ambient temperature limit: -40 °C ... +125 °C
- made of self-extinguishing thermoplastic resin UL 94V-0
- mechanical life: ≥ 500 cycles
- contact resistance: ≤ 1 mΩ
- for max. current load see the connector inserts derating diagram below; for more information see page 28

**CQE 92 poles connector inserts**  
**Maximum current load derating diagram**

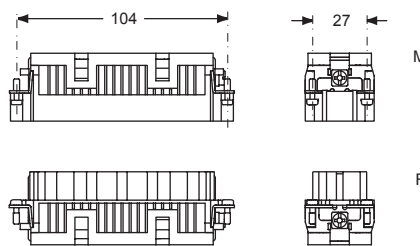
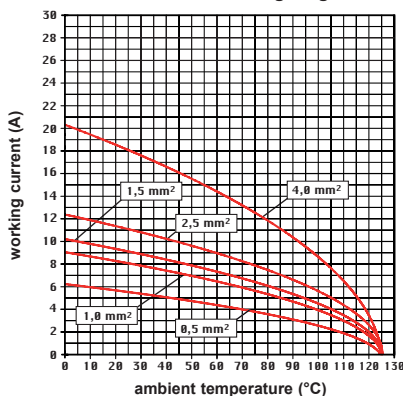

contacts side (front view)

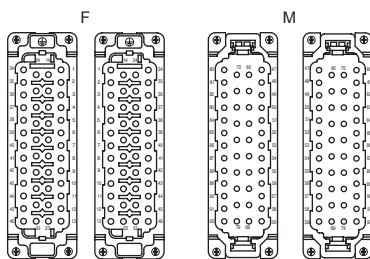

CR CPQ coding pins  
(page 689)



### CCF and CCM

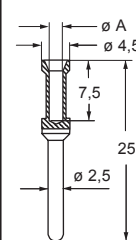

### CC...AN

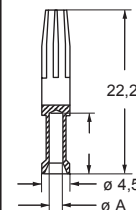
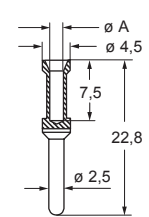

- it is recommended to crimp the contacts with crimping tools homologated by ILME (please see the crimping tool section 16A contacts, CCF, CCM and CC...AN series on pages 705 - 741)

### CCF, CCM and CC...AN contacts

conductor section mm <sup>2</sup>	conductor slot ø A (mm)	conductors stripping length (mm)
0,14-0,37	0,9	7,5
0,5	1,1	7,5
0,75	1,3	7,5
1,0	1,45	7,5
1,5	1,8	7,5
2,5	2,2	7,5
3	2,55	7,5
4	2,85	7,5

## CQEE series

### TECHNICAL FEATURES

Connector inserts series **CQEE** are the logical extension of the existing series CQE for removable crimp contacts series CC (16A max, available both in gold plated and in silver plated version) that include the CC...AN pin contacts with anticipated opening (first-to-break) and delayed closing (last-to-make).

Compared with the connector inserts of the same size of series CQE, connector inserts series **CQEE** provide a sensibly higher number of contacts: 64P+⊕ instead of 46P+⊕ for size 104.27 (+39%), 40P+⊕ instead of 32P+⊕ for size 77.27 (+25%).

With the same number of circuits, it is conversely possible to reduce the size of the connector inserts and of the related hood and housing, thus reducing the overall cost.

Connector inserts series **CQEE** may replace in the same size (77.27, 104.27) and with the same contact density (40P+⊕ and 64P+⊕) the corresponding inserts of series CD for removable crimp contacts series CD (10A max).

This may be particularly useful when, as a function of the intended use, it is required:

- to use the connector at a higher rated voltage: CQEE covers use at 500V / 6kV / 3 where CD stops at 250V / 4kV / 3;
- to assign a larger current-carrying capacity, both due to the lower contact resistance (1 mΩ instead of 3 mΩ) and the larger wire size available for series CC compared with series CD contacts;
- to use wires with the larger cross-sectional area of 4 mm<sup>2</sup> / AWG 12, in order to contain the percent voltage drop [%] in circuits fed with extra-low voltage and with comparatively high currents, or in circuits of considerable length;
- to use crimp contacts with inherently higher mechanical robustness;
- to use anticipated pin contacts CC...AN (e.g. for the remote signal ring of the "OPEN" or "CLOSED" status of the connector).

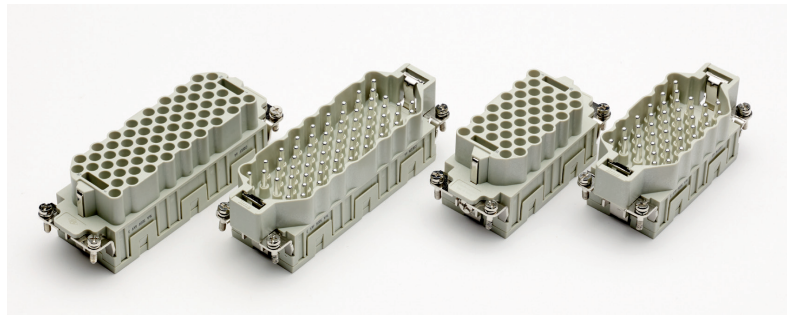

## CQEE series

### TECHNICAL FEATURES

Inserts series		CQEE
No. of poles	main contacts + ⊕	<b>40 + ⊕, 64 + ⊕</b>
rated current <sup>1)</sup>		16A
EN 61984 pollution degree 3	rated voltage	500V
	rated impulse voltage	6kV
	pollution degree	3
EN 61984 pollution degree 2	rated voltage	830V
	rated impulse voltage	6kV
	pollution degree	2
UL/CSA certification	rated voltage AC/DC	600V
contact resistance		≤ 1 mΩ
insulation resistance		≥ 10 GΩ
ambient temperature limit (°C)	min	-40 °C
	max	+125 °C
degree of protection	with enclosures (according to version)	<b>IP65, IP66/IP69, IP66/IP67/IP69, IP66/IP68/IP69</b> (according to type and model) (according to type and model)
	without enclosures	<b>IP20</b> (IPXXB)
conductor connections		crimp (only ⊕: screw)
conductor cross-section (CC contact series)	mm <sup>2</sup>	0,14 ..... 4,0
	AWG	26 - 12
stripping length	mm	7,5
mechanical endurance (mating cycles)		≥ 500

1) Please check the inserts derating diagrams to establish the actual maximum operating current according to the ambient temperature, the conductor cross-sectional area, the polarity of the connector, and any external constraint that may derive e.g. by the continuous operating temperature sustained by the chosen conductor sheathing or by end-product safety standards fixing max allowed temperature rise on terminals (e.g. 30 K, 45 K or 50 K)



# CQEE 40 poles + ⊕ 16A - 500V

enclosures: size "77.27"	page:
C-TYPE IP65/IP66	402 - 411
C7 IP67, two levers	439 - 440
V-TYPE IP65/IP66, single lever	454 - 458
BIG hoods	470 - 471
T-TYPE IP65 insulating	484 - 485
T-TYPE / W IP66 insulating	491
HYGIENIC T-TYPE / H IP66/IP69	503
HYGIENIC T-TYPE / C IP66/IP69, -50 °C	508
W-TYPE for aggressive environments	523
E-Xtreme® corrosion proof	534 - 535, 544, 554 - 555
EMC	580
Central lever	609 - 611
LS-TYPE	622 - 623
IP68	640 - 643
panel supports: COB	page: 652 - 653

## inserts, crimp connections

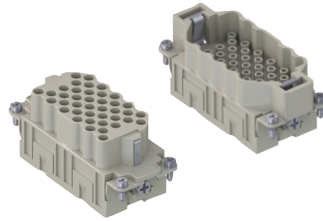

## 16A crimp contacts standard or for advanced opening silver and gold plated



STANDARD

ADVANCED OPENING

description	part No.	part No.
without contacts (to be ordered separately)		
female inserts for female contacts	<b>CQEEF 40</b>	
male inserts for male contacts	<b>CQEEM 40</b>	
16A female contacts		
0,14-0,37 mm <sup>2</sup> AWG 26-22 one groove		<b>CCFA 0.3</b>
0,5 mm <sup>2</sup> AWG 20 with no grooves		<b>CCFA 0.5</b>
0,75 mm <sup>2</sup> AWG 18 one groove (back side)		<b>CCFA 0.7</b>
1 mm <sup>2</sup> AWG 18 one groove		<b>CCFA 1.0</b>
1,5 mm <sup>2</sup> AWG 16 two grooves		<b>CCFA 1.5</b>
2,5 mm <sup>2</sup> AWG 14 three grooves		<b>CCFA 2.5</b>
3 mm <sup>2</sup> AWG 12 one wide groove		<b>CCFA 3.0</b>
4 mm <sup>2</sup> AWG 12 with no grooves		<b>CCFA 4.0</b>
16A male contacts		
0,14-0,37 mm <sup>2</sup> AWG 26-22 one groove		<b>CCMA 0.3</b>
0,5 mm <sup>2</sup> AWG 20 with no grooves		<b>CCMA 0.5</b>
0,75 mm <sup>2</sup> AWG 18 one groove (back side)		<b>CCMA 0.7</b>
1 mm <sup>2</sup> AWG 18 one groove		<b>CCMA 1.0</b>
1,5 mm <sup>2</sup> AWG 16t wo grooves		<b>CCMA 1.5</b>
2,5 mm <sup>2</sup> AWG 14 three grooves		<b>CCMA 2.5</b>
3 mm <sup>2</sup> AWG 12 one wide groove		<b>CCMA 3.0</b>
4 mm <sup>2</sup> AWG 12 with no grooves		<b>CCMA 4.0</b>
16A male crimp contacts for advanced opening		
0,5 mm <sup>2</sup> AWG 20 with no grooves		<b>CC 0.5 AN</b>
0,75 mm <sup>2</sup> AWG 18 one groove (back side)		<b>CC 0.7 AN</b>
1 mm <sup>2</sup> AWG 18 one groove		<b>CC 1.0 AN</b>
1,5 mm <sup>2</sup> AWG 16 two grooves		<b>CC 1.5 AN</b>
2,5 mm <sup>2</sup> AWG 14 three grooves		<b>CC 2.5 AN</b>

silver plated

gold plated\*

\* for basic or high thickness gold plating, please refer to page 675

- characteristics according to EN 61984:  
**16A 500V 6kV 3**
- us (UL for USA and Canada),
- certified
- rated voltage according to UL/CSA: 600V
- insulation resistance: ≥ 10 GΩ
- ambient temperature limit: -40 °C ... +125 °C
- made of self-extinguishing thermoplastic resin UL 94V-0
- mechanical life: ≥ 500 cycles
- contact resistance: ≤ 1 mΩ
- **it is recommended to crimp the contacts with crimping tools homologated by ILME** (please see the crimping tool section 16A contacts, CCF, CCM and CC...AN series on pages 705 - 741)
- for max. current load see the connector inserts derating diagram below; for more information see page 28

**CQEE 40 poles connector inserts**  
Maximum current load derating diagram

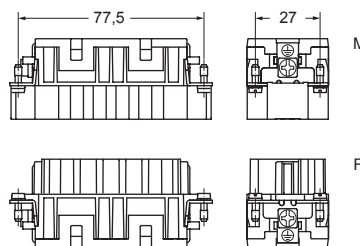
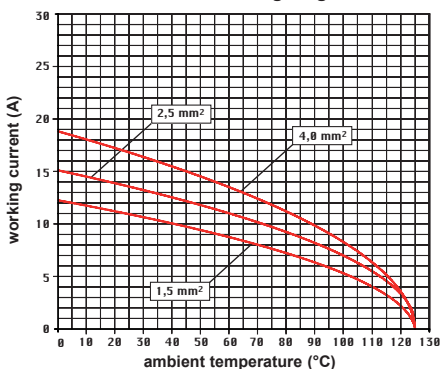

contacts side (front view)

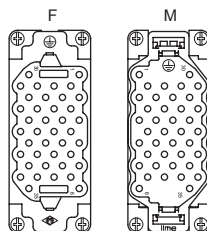

CR CPQ coding pins  
(page 689)



### CCF and CCM

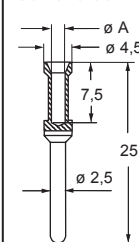

### CC...AN

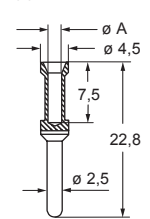

### CCF, CCM and CC...AN contacts

conductor section mm <sup>2</sup>	conductor slot ø A (mm)	conductors stripping length (mm)
0,14-0,37	0,9	7,5
0,5	1,1	7,5
0,75	1,3	7,5
1,0	1,45	7,5
1,5	1,8	7,5
2,5	2,2	7,5
3	2,55	7,5
4	2,85	7,5



# CQEE 64 poles + ⊕ 16A - 500V

enclosures: size "104.27"	page:
C-TYPE IP65/IP66	412 - 423
C7 IP67, two levers	441 - 442
V-TYPE IP65/IP66, single lever	459 - 463
BIG hoods	472 - 473
T-TYPE IP65 insulating	486 - 487
T-TYPE / W IP66 insulating	492
HYGIENIC T-TYPE / H IP66/IP69	504
HYGIENIC T-TYPE / C IP66/IP69, -50 °C	509
W-TYPE for aggressive environments	524
E-Xtreme® corrosion proof	536 - 537, 545, 556 - 557
EMC	581
Central lever	612 - 614
LS-TYPE	624 - 625
IP68	644 - 647
panel supports: COB	page: 652 - 653

## inserts, crimp connections

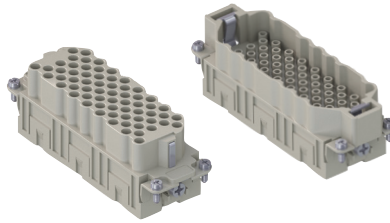

## 16A crimp contacts standard or for advanced opening silver and gold plated

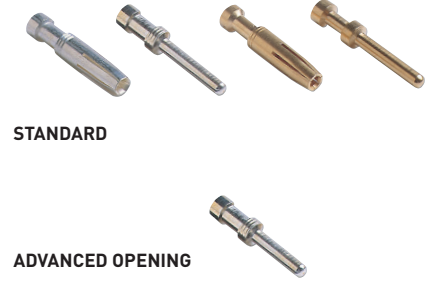

description	part No.	part No.
without contacts (to be ordered separately)		
female inserts for female contacts	<b>CQEEF 64</b>	
male inserts for male contacts	<b>CQEEM 64</b>	
<b>16A female contacts</b>		
0,14-0,37 mm <sup>2</sup> AWG 26-22 one groove		<b>CCFA 0.3</b>
0,5 mm <sup>2</sup> AWG 20 with no grooves		<b>CCFA 0.5</b>
0,75 mm <sup>2</sup> AWG 18 one groove (back side)		<b>CCFA 0.7</b>
1 mm <sup>2</sup> AWG 18 one groove		<b>CCFA 1.0</b>
1,5 mm <sup>2</sup> AWG 16 two grooves		<b>CCFA 1.5</b>
2,5 mm <sup>2</sup> AWG 14 three grooves		<b>CCFA 2.5</b>
3 mm <sup>2</sup> AWG 12 one wide groove		<b>CCFA 3.0</b>
4 mm <sup>2</sup> AWG 12 with no grooves		<b>CCFA 4.0</b>
		<b>silver plated</b>
		<b>gold plated+*</b>
<b>16A male contacts</b>		
0,14-0,37 mm <sup>2</sup> AWG 26-22 one groove		<b>CCMA 0.3</b>
0,5 mm <sup>2</sup> AWG 20 with no grooves		<b>CCMA 0.5</b>
0,75 mm <sup>2</sup> AWG 18 one groove (back side)		<b>CCMA 0.7</b>
1 mm <sup>2</sup> AWG 18 one groove		<b>CCMA 1.0</b>
1,5 mm <sup>2</sup> AWG 16t wo grooves		<b>CCMA 1.5</b>
2,5 mm <sup>2</sup> AWG 14 three grooves		<b>CCMA 2.5</b>
3 mm <sup>2</sup> AWG 12 one wide groove		<b>CCMA 3.0</b>
4 mm <sup>2</sup> AWG 12 with no grooves		<b>CCMA 4.0</b>
		<b>silver plated</b>
		<b>gold plated+*</b>
<b>16A male crimp contacts for advanced opening</b>		
0,5 mm <sup>2</sup> AWG 20 with no grooves		<b>CC 0.5 AN</b>
0,75 mm <sup>2</sup> AWG 18 one groove (back side)		<b>CC 0.7 AN</b>
1 mm <sup>2</sup> AWG 18 one groove		<b>CC 1.0 AN</b>
1,5 mm <sup>2</sup> AWG 16 two grooves		<b>CC 1.5 AN</b>
2,5 mm <sup>2</sup> AWG 14 three grooves		<b>CC 2.5 AN</b>
		<b>silver plated</b>
		<b>gold plated+*</b>

- characteristics according to EN 61984:  
**16A 500V 6kV 3**  
 - cULus (UL for USA and Canada), SR, CEC, DNV-GL  
 - Bureau Veritas EAC certified  
 - rated voltage according to UL/CSA: 600V  
 - insulation resistance: ≥ 10 GΩ  
 - ambient temperature limit: -40 °C ... +125 °C  
 - made of self-extinguishing thermoplastic resin UL 94V-0  
 - mechanical life: ≥ 500 cycles  
 - contact resistance: ≤ 1 mΩ  
 - it is recommended to crimp the contacts with crimping tools homologated by ILME (please see the crimping tool section 16A contacts, CCF, CCM and CC...AN series on pages 705 - 741)  
 - for max. current load see the connector inserts derating diagram below; for more information see page 28

**CQEE 64 poles connector inserts  
Maximum current load derating diagram**

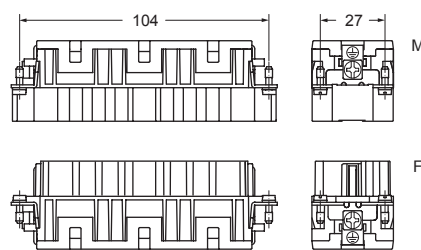
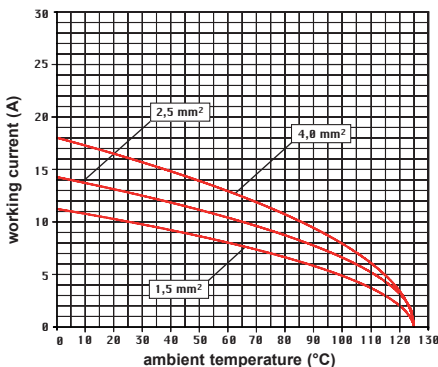

contacts side (front view)

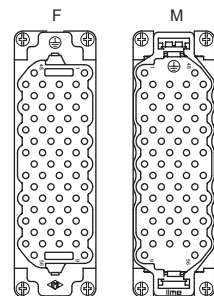

CR CPQ coding pins  
(page 689)



### CCF and CCM

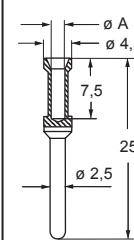

### CC...AN

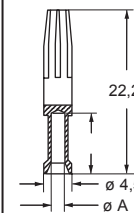
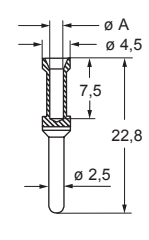

### CCF, CCM and CC...AN contacts

conductor section mm <sup>2</sup>	conductor slot ø A (mm)	conductors stripping length (mm)
0,14-0,37	0,9	7,5
0,5	1,1	7,5
0,75	1,3	7,5
1,0	1,45	7,5
1,5	1,8	7,5
2,5	2,2	7,5
3	2,55	7,5
4	2,85	7,5

# CP - CP...RY 6 poles + ⊕ 35A - 400/690V

enclosures: size "77.27"	page:
C-TYPE IP65/IP66	402 - 411
C7 IP67, two levers	439 - 440
V-TYPE IP65/IP66, single lever	454 - 458
BIG hoods	470 - 471
T-TYPE IP65 insulating	484 - 485
T-TYPE / W IP66 insulating	491
HYGIENIC T-TYPE / H IP66/IP69	503
HYGIENIC T-TYPE / C IP66/IP69, -50 °C	508
W-TYPE for aggressive environments	523
E-Xtreme® corrosion proof	534 - 535, 544, 554 - 555
EMC	580
Central lever	609 - 611
LS-TYPE	622 - 623
IP68	640 - 643
panel supports: COB	page: 652 - 653

inserts, screw terminal connection

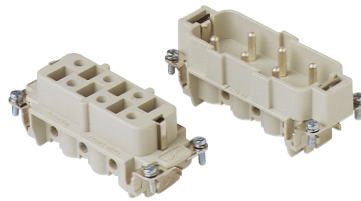

**Q SILVER PLATED CONTACTS**

inserts, screw terminal connection

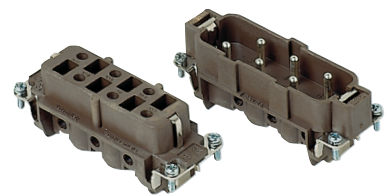

**Q SILVER PLATED CONTACTS**

description

part No.

part No.

indirect, with plate  
female inserts with female contacts  
male inserts with male contacts

CPF 06  
CPM 06

indirect, with plate, use in temperatures up to 180 °C  
female inserts with female contacts, brown  
male inserts with male contacts, brown

CPF 06 RY  
CPM 06 RY

- characteristics according to EN 61984:
- 35A 400/690V 6kV 3**
- certified
- rated voltage according to UL/CSA: 600V
- insulation resistance: ≥ 10 GΩ
- ambient temperature limit: -40 °C ... +125 °C (CP RY version up to 180 °C)
- made of self-extinguishing thermoplastic resin UL 94V-0
- mechanical life: ≥ 500 cycles
- contact resistance: ≤ 0,5 mΩ
- for max. current load see the connector inserts derating diagrams below; for more information see page 28

**CP 06 poles connector inserts**  
Maximum current load derating diagram

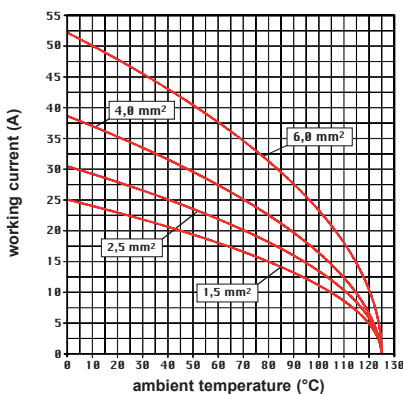

**CP...RY 06 poles connector inserts**  
Maximum current load derating diagram

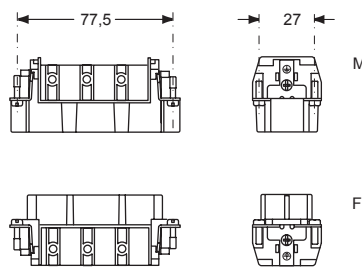
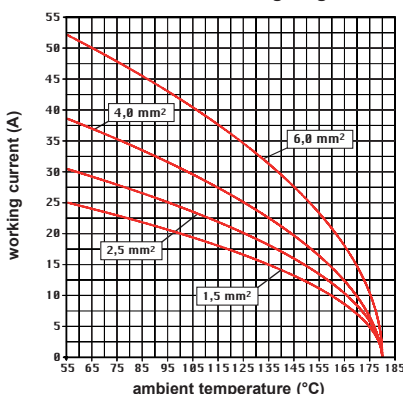

contacts side (front view)

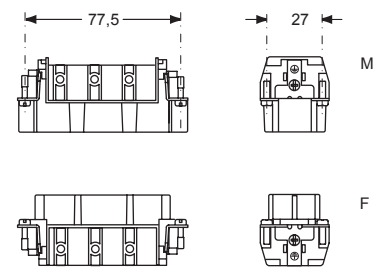
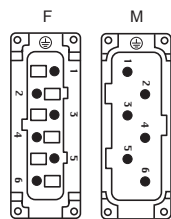

contacts side (front view)

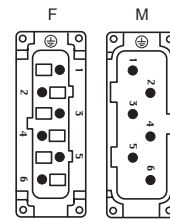

- inserts with plate, for section conductors: 0,75 - 6 mm² - AWG 18 - 10
- conductors stripping length: 10,5 mm
- terminal screw torque: 1,2 Nm (10,7 lb.in), information see page 20 and 21

- inserts with plate, for section conductors: 0,75 - 6 mm² - AWG 18 - 10
- conductors stripping length: 10,5 mm
- terminal screw torque: 1,2 Nm (10,7 lb.in), information see page 20 and 21

CP - CP...RY

# CP 12 poles + ⊕ 35A - 400/690V

enclosures:  
size "77.62"

page:

C-TYPE IP65/IP66

424 - 429

W-TYPE for aggressive environments

525

E-Xtreme® corrosion proof

546

## inserts, screw terminal connection

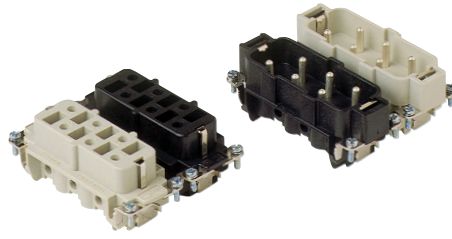

### Q SILVER PLATED CONTACTS

description	part No.	part No.
indirect, with plate female inserts No. (1-6), white and black male inserts No. (1-6), white and black	<b>CPF 06</b> <b>CPM 06</b>	<b>CPF 06 N</b> <b>CPM 06 N</b>

- characteristics according to EN 61984:

**35A 400/690V 6kV 3**

certified

- rated voltage according to UL/CSA: 600V

- insulation resistance:  $\geq 10 \text{ G}\Omega$

- ambient temperature limit:  $-40 \text{ }^\circ\text{C} \dots +125 \text{ }^\circ\text{C}$

(CP RY version up to  $180 \text{ }^\circ\text{C}$ )

- made of self-extinguishing thermoplastic resin UL 94V-0

- mechanical life:  $\geq 500$  cycles

- contact resistance:  $\leq 0,5 \text{ m}\Omega$

- for max. current load see the connector inserts derating diagrams below; for more information see page 28

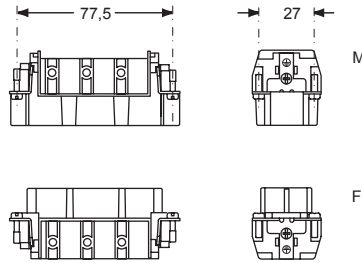

contacts side (front view)

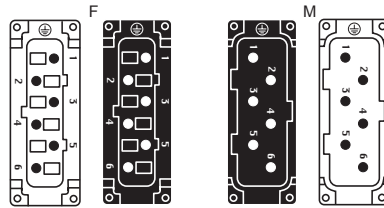

**CP 12 poles connector inserts**  
**Maximum current load derating diagram**

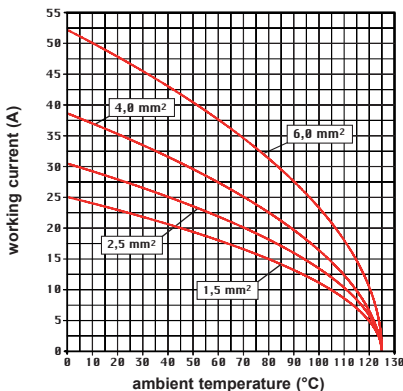

- inserts with plate, for section conductors: 0,75 - 6 mm<sup>2</sup> - AWG 18 - 10
- conductors stripping length: 10,5 mm
- terminal screw torque: 1,2 Nm (10,7 lb.in), information see page 20 and 21

## CQ4 (CQ4F /M 02 – CQ4F /M 02 H – CQ4F /M 03)

### Compact size “21.21” for high current or higher voltage

- Compact size “21.21” **2P+PE** and **3P+PE** connector inserts for **high current (40 A)**, and either standard voltage up to 400 V or **higher voltage 830 V**, ideally complemented by the expanding range of hoods and housings size “21.21” with **M25** threaded cable entry, either insulating or metallic (**MK, MKA, MGK**), which are particularly suitable for use with high cross-sectional area conductors (large cable diameter).

- Series **CQ4** encompasses the following size “21.21” connector inserts:

› **CQ4F /M 03** with 3P+PE with up to 40 A current-carrying capacity and standard rated voltage up to 400 V (e.g. for 3-phase motor connections);

› **CQ4F /M 02** with 2P+PE with up to 40 A current-carrying capacity and standard rated voltage up to 400 V (e.g. for 1-phase AC or for DC power connections), this one with better current-carrying capacity by the derating diagrams, due to a power contact less in the same space;

› **CQ4F /M 02 H** with 2P+PE with up to 40 A current-carrying capacity and higher rated voltage applications, up to **830 V** (for 1-phase AC or for DC higher power connections).

- Suitable for series **CX** crimp contacts (including the **PE pre-leading one**), covering stranded copper conductors cross sectional area range **1,5 mm<sup>2</sup> to 10 mm<sup>2</sup>** (16 AWG to 8 AWG).

- Protection against direct contact when unmated:

› **CQ4F 02**: both male and female connector inserts are **fingerproof (IP2X)** even on the mating face when uncoupled (useful e.g. when a male connector is on the motor side of a drive including capacitors, potentially charged for residual time).

› **CQ4F 03**: the female insert is **fingerproof (IP2X)** even on the mating face when uncoupled, while the male insert **CQ4M 03** in that circumstance is protected from access with the back of the hand (IP1X).

- **CQ4F /M 02** and **CQ4F /M 02 H** specific features:

› Special **polarisation key** on the connector bodies mating face of both versions, differently oriented, to avoid the mismatching of CQ4F /M 02 H **830 V** version with the lower voltage CQ4F /M 02 **400 V** version.

› **CQ4F /M 02 H** supplied with a **special insulating heat-shrinking tube** that provides the required additional insulation towards a metal housing.

› **CQ4F /M 02 H** specific **830 V** rated voltage duly marked on the inserts, to avoid any possible confusion with similar CQ4F /M 02 for 400 V.

- Codings:

› **CQ4 03**: possibility of up to **4 different codings** thanks to the use of the **optional CR Q03 coding pin** (4 possible positions);

› **CQ4 02** and **CQ4 02 H**: possibility of up to **16 different codings** thanks to the use of **two optional CR Q02 coding pins** (it is possible to install two pins with 4 positions each).

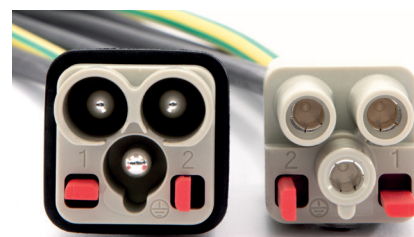

**CQ4F/M 02**  
Lower voltage version

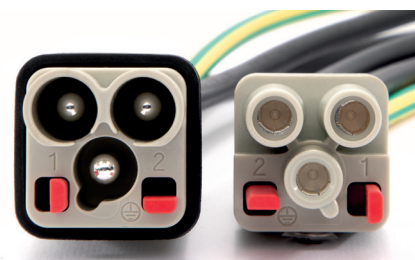

**CQ4F/M 02 H**  
Higher 830V voltage version

## CQ4 series

### TECHNICAL FEATURES

Inserts series		CQ4		
Cat. No.		CQ4F /M 02	CQ4F /M 02 H	CQ4F /M 03
No. of poles		2 + ⊕	2 + ⊕	3 + ⊕
rated current <sup>1)</sup>		40 A		
EN 61984 pollution degree 3	rated voltage	400 V	830 V	400 V
	rated impulse voltage	6 kV		
	pollution degree	3		
contact resistance		≤ 0,3 mΩ		
insulation resistance		≥ 10 GΩ		
ambient temperature limit (°C)	min (LLT)	-40 °C		
	max (ULT)	+125 °C		
degree of protection	with enclosures (according to version)	IP44, IP65, IP66, IP67, IP68, IP69		
conductor connections		crimp		
conductor cross-sectional area	mm <sup>2</sup>	1,5 ..... 10		
	AWG	16 ..... 8		
stripping length	mm	9 - 9,6 - 15 (according to contact size)		
mechanical endurance (mating cycles)		≥ 500		

<sup>1)</sup> See derating diagrams

**CQ4F/M 02 2 poles + ⊕ 40A - 400V**

enclosures:  
size "21.21"

page:

Insulating type	339 - 348
Metallic type	349 - 363
W-TYPE for aggressive environments	512 - 518
EMC	564 - 572
IP68	628 - 631
E-Xtreme® corrosion proof	538 - 539

- cannot be used in angled enclosures  
(IA/IAP/VA version)

inserts, crimp connections

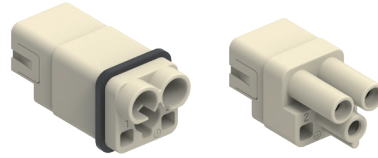

**AVAILABLE JUNE 2019**

40A crimp contacts  
silver plated



description

part No.

part No.

without contacts (to be ordered separately), including PE  
female inserts for female contacts  
male inserts for male contacts

**CQ4F 02**  
**CQ4M 02**

40A female crimp contacts

1,5 mm <sup>2</sup>	AWG 16
2,5 mm <sup>2</sup>	AWG 14
4 mm <sup>2</sup>	AWG 12
6 mm <sup>2</sup>	AWG 10
10 mm <sup>2</sup>	AWG 8

**CXFA 1.5**  
**CXFA 2.5**  
**CXFA 4.0**  
**CXFA 6.0**  
**CXFA 10**

silver plated

40A male crimp contacts

1,5 mm <sup>2</sup>	AWG 16
2,5 mm <sup>2</sup>	AWG 14
4 mm <sup>2</sup>	AWG 12
6 mm <sup>2</sup>	AWG 10
10 mm <sup>2</sup>	AWG 8

**CXMA 1.5**  
**CXMA 2.5**  
**CXMA 4.0**  
**CXMA 6.0**  
**CXMA 10**

- characteristics according to EN 61984:

**40A 400V 6kV 3**

- cURus, CSA, CQC, DNV-GL, BV, EAC pending
- rated voltage according to UL/CSA: 600V
- insulation resistance: ≥ 10 GΩ
- ambient temperature limit: -40 °C ... +125 °C
- made of self-extinguishing thermoplastic resin UL 94V-0
- mechanical life: ≥ 500 cycles
- contact resistance: ≤ 0,3 mΩ
- **it is recommended to crimp the contacts with crimping tools homologated by ILME** (please see the crimping tool section 40A contacts CXF and CXM series, on pages 705 - 741)

- wire diameter: up to 7,5 mm  
conductor cross-sectional area: up to 10 mm<sup>2</sup>

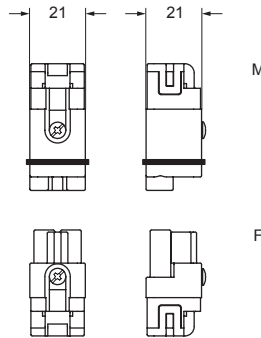

contacts side (front view)



Coding pins  
CR Q02  
(page 691)

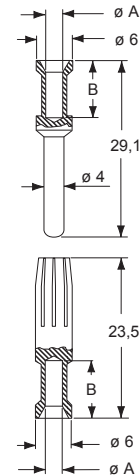

**CXF and CXM contacts**

conductor cross-sectional area (mm <sup>2</sup> )	conductor slot ø A (mm)	conductor stripping length B (mm)
1,5	1,8	9
2,5	2,2	9
4	2,85	9,6
6	3,5	9,6
10	4,3	15

CQ



# CQ4F/M 02 H 2 poles + ⊕ 40A - 830V

enclosures:  
size "21.21"

page:

Insulating type	339 - 348
Metallic type	349 - 363
W-TYPE for aggressive environments	512 - 518
EMC	564 - 572
IP68	628 - 631
E-Xtreme® corrosion proof	538 - 539

- cannot be used in angled enclosures  
(IA/IAF/VA version)

inserts, crimp connections  
heat-shrinking tube

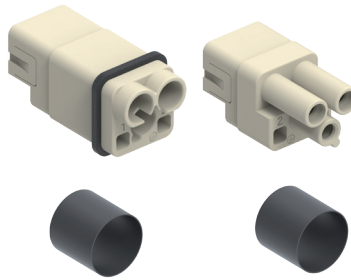

**HIGHER VOLTAGE 830V**  
 **AVAILABLE JUNE 2019**

40A crimp contacts  
silver plated



description	part No.	part No.
-------------	----------	----------

without contacts (to be ordered separately), including PE  
female inserts for female contacts  
male inserts for male contacts

**CQ4F 02 H**  
**CQ4M 02 H**

40A female crimp contacts

1,5 mm <sup>2</sup>	AWG 16
2,5 mm <sup>2</sup>	AWG 14
4 mm <sup>2</sup>	AWG 12
6 mm <sup>2</sup>	AWG 10
10 mm <sup>2</sup>	AWG 8

**CXFA 1.5**  
**CXFA 2.5**  
**CXFA 4.0**  
**CXFA 6.0**  
**CXFA 10**

silver plated

40A male crimp contacts

1,5 mm <sup>2</sup>	AWG 16
2,5 mm <sup>2</sup>	AWG 14
4 mm <sup>2</sup>	AWG 12
6 mm <sup>2</sup>	AWG 10
10 mm <sup>2</sup>	AWG 8

**CXMA 1.5**  
**CXMA 2.5**  
**CXMA 4.0**  
**CXMA 6.0**  
**CXMA 10**

- characteristics according to EN 61984:

**40A 830V 6kV 3**

- cURus, CSA, CQC, DNV-GL, BV, EAC pending
- rated voltage according to UL/CSA: 600V
- insulation resistance: ≥ 10 GΩ
- ambient temperature limit: -40 °C ... +125 °C
- made of self-extinguishing thermoplastic resin UL 94V-0
- mechanical life: ≥ 500 cycles
- contact resistance: ≤ 0,3 mΩ
- **it is recommended to crimp the contacts with crimping tools homologated by ILME** (please see the crimping tool section 40A contacts CXF and CXM series, on pages 705 - 741)

- wire diameter: up to 7,5 mm  
conductor cross-sectional area: up to 10 mm<sup>2</sup>

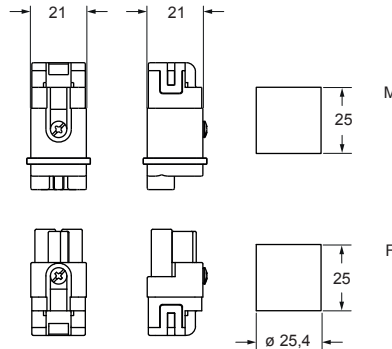

contacts side (front view)

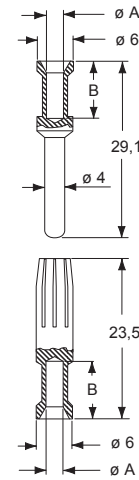

**CXF and CXM contacts**

conductor cross-sectional area (mm <sup>2</sup> )	conductor slot ø A (mm)	conductor stripping length B (mm)
1,5	1,8	9
2,5	2,2	9
4	2,85	9,6
6	3,5	9,6
10	4,3	15

Coding pins  
CR Q02  
(page 691)



# CQ 3 poles + ⊕ 40A - 400V

enclosures: size "21.21"	page:
Insulating type	339 - 348
Metallic type	349 - 363
W-TYPE for aggressive environments	512 - 518
EMC	564 - 572
IP68	628 - 631
E-Xtreme® corrosion proof	538 - 539

inserts, crimp connections

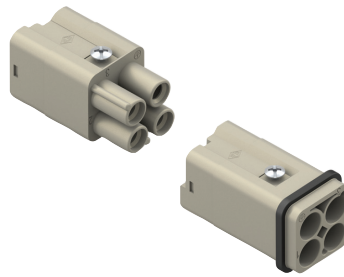

40A crimp contacts  
silver plated



- cannot be used in angled enclosures (IA/IAP/VA version)

description	part No.	part No.
-------------	----------	----------

without contacts (to be ordered separately)  
female inserts for female contacts \*  
male inserts for male contacts \*

**CQ4F 03**  
**CQ4M 03**

40A female crimp contacts

1,5 mm <sup>2</sup>	AWG 16
2,5 mm <sup>2</sup>	AWG 14
4 mm <sup>2</sup>	AWG 12
6 mm <sup>2</sup>	AWG 10
10 mm <sup>2</sup>	AWG 8

**CXFA 1.5**  
**CXFA 2.5**  
**CXFA 4.0**  
**CXFA 6.0**  
**CXFA 10**

silver plated

40A male crimp contacts

1,5 mm <sup>2</sup>	AWG 16
2,5 mm <sup>2</sup>	AWG 14
4 mm <sup>2</sup>	AWG 12
6 mm <sup>2</sup>	AWG 10
10 mm <sup>2</sup>	AWG 8

**CXMA 1.5**  
**CXMA 2.5**  
**CXMA 4.0**  
**CXMA 6.0**  
**CXMA 10**

- the female insert **CQ4F 03** is finger proof (IP2X or IPXXB) even if not coupled, while the male insert **CQ4M 03** in this circumstance is protected from access with the back of the hand (IP1X or IPXXA).

- characteristics according to EN 61984:

**40A 400V 6kV 3**

- (UL for USA and Canada),

**ERC** certified

- insulation resistance:  $\geq 10 \text{ G}\Omega$
- ambient temperature limit:  $-40 \text{ }^\circ\text{C} \dots +125 \text{ }^\circ\text{C}$
- made of self-extinguishing thermoplastic resin UL 94V-0
- mechanical life:  $\geq 500$  cycles
- contact resistance:  $\leq 0,3 \text{ m}\Omega$
- **it is recommended to crimp the contacts with crimping tools homologated by ILME** (please see the crimping tool section 40A contacts CXF and CXM series, on pages 705 - 741)
- for max. current load see the connector inserts derating diagram below; for more information see page 28

\* cable diameter: up to 7,5 mm  
contact section: up to 10 mm<sup>2</sup>

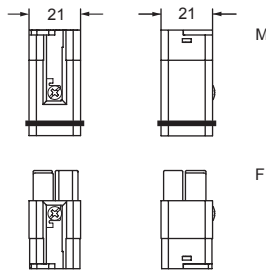

contacts side (front view)

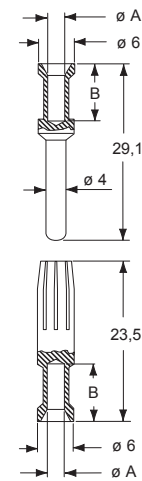

**CXF and CXM contacts**

conductor section mm <sup>2</sup>	conductor slot $\phi A$ (mm)	conductors stripping length B (mm)
1,5	1,8	9
2,5	2,2	9
4	2,85	9,6
6	3,5	9,6
10	4,3	15

**CQ4 03, 3 poles + PE connector inserts**  
Maximum current load derating diagram

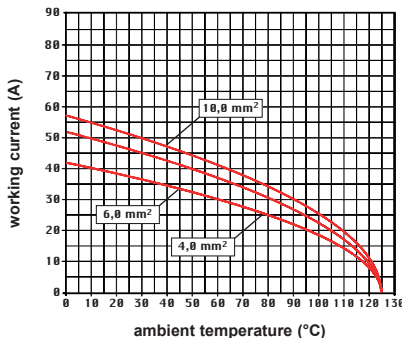

Coding pins  
**CR Q03**  
(4 possible positions)  
(page 693)



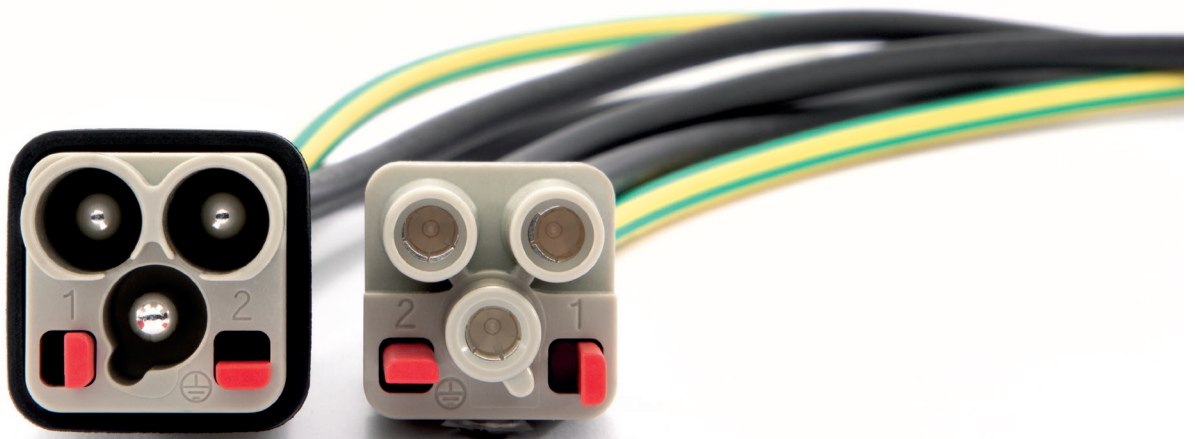

# CQ 5 poles + ⊕ 16A - 230/400V

enclosures:  
size "21.21"

page:

Insulating type	339 - 348
Metallic type	349 - 363
W-TYPE for aggressive environments	512 - 518
EMC	564 - 572
IP68	628 - 631
E-Xtreme® corrosion proof	538 - 539

- it is recommended to crimp the contacts with crimping tools homologated by ILME (please see the crimping tool section 16A contacts, CCF, CCM and CC...AN series on pages 705 - 741)
- inserts and enclosures for applications with temperatures up to 180 °C, available on request
- can also be used partially fitted with 4 mm² section contacts

## inserts, crimp connections



## 16A crimp contacts standard or for advanced opening silver and gold plated



STANDARD

ADVANCED OPENING

description	part No.	part No.
without contacts (to be ordered separately)		
female inserts for female contacts	<b>CQF 05</b>	
male inserts for male contacts	<b>CQF 05</b>	
16A female contacts		
0,14-0,37 mm² AWG 26-22 one groove		<b>CCFA 0.3</b>
0,5 mm² AWG 20 with no grooves		<b>CCFA 0.5</b>
0,75 mm² AWG 18 one groove (back side)		<b>CCFA 0.7</b>
1 mm² AWG 18 one groove		<b>CCFA 1.0</b>
1,5 mm² AWG 16 two grooves		<b>CCFA 1.5</b>
2,5 mm² AWG 14 three grooves		<b>CCFA 2.5</b>
3 mm² AWG 12 one wide groove		<b>CCFA 3.0</b>
4 mm² AWG 12 with no grooves		<b>CCFA 4.0</b>
16A male contacts		
0,14-0,37 mm² AWG 26-22 one groove		<b>CCMA 0.3</b>
0,5 mm² AWG 20 with no grooves		<b>CCMA 0.5</b>
0,75 mm² AWG 18 one groove (back side)		<b>CCMA 0.7</b>
1 mm² AWG 18 one groove		<b>CCMA 1.0</b>
1,5 mm² AWG 16t wo grooves		<b>CCMA 1.5</b>
2,5 mm² AWG 14 three grooves		<b>CCMA 2.5</b>
3 mm² AWG 12 one wide groove		<b>CCMA 3.0</b>
4 mm² AWG 12 with no grooves		<b>CCMA 4.0</b>
16A male crimp contacts for advanced opening		
0,5 mm² AWG 20 with no grooves		<b>CC 0.5 AN</b>
0,75 mm² AWG 18 one groove (back side)		<b>CC 0.7 AN</b>
1 mm² AWG 18 one groove		<b>CC 1.0 AN</b>
1,5 mm² AWG 16 two grooves		<b>CC 1.5 AN</b>
2,5 mm² AWG 14 three grooves		<b>CC 2.5 AN</b>

silver plated

gold plated<sup>+</sup>

<sup>+</sup> for basic or high thickness gold plating, please refer to page 675

- characteristics according to EN 61984:

**16A 230/400V 4kV 3**  
**16A 320/500V 4kV 2**

- cULus (UL for USA and Canada),

certified

- rated voltage according to UL/CSA: 600V
- insulation resistance: ≥ 10 GΩ
- ambient temperature limit: -40 °C ... +125 °C
- made of self-extinguishing thermoplastic resin UL 94V-0
- mechanical life: ≥ 500 cycles
- contact resistance: ≤ 1 mΩ
- for max. current load see the connector inserts derating diagram below; for more information see page 28

**CQ 05 poles connector inserts**  
**Maximum current load derating diagram**

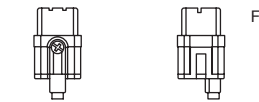
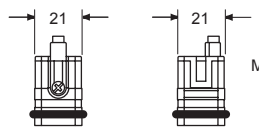
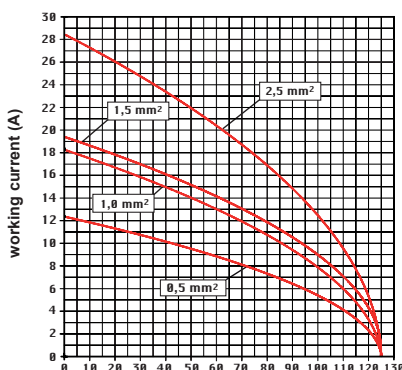

contacts side (front view)



**Note:**  
PE screw connection for unprepared wires only

**Coding pins CR CPQ**  
(page 689)



### CCF and CCM

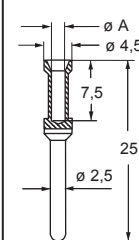

### CC...AN

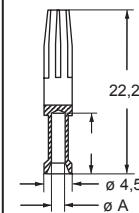
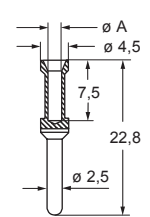

### CCF, CCM and CC...AN contacts

conductor section mm²	conductor slot ø A (mm)	conductors stripping length (mm)
0,14-0,37	0,9	7,5
0,5	1,1	7,5
0,75	1,3	7,5
1,0	1,45	7,5
1,5	1,8	7,5
2,5	2,2	7,5
3	2,55	7,5
4	2,85	7,5

# CQ 7 poles + ⊕ 10A - 400V

enclosures: size "21.21"	page:
Insulating type	339 - 348
Metallic type	349 - 363
W-TYPE for aggressive environments	512 - 518
EMC	564 - 572
IP68	628 - 631
E-Xtreme® corrosion proof	538 - 539

## inserts, crimp connections

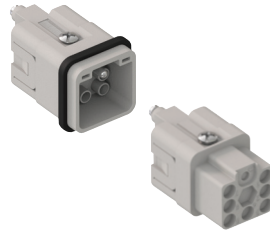

## 10A crimp contacts silver and gold plated



description	part No.	part No.
without contacts (to be ordered separately)		
female inserts for female contacts	<b>CQF 07</b>	
male inserts for male contacts	<b>CQM 07</b>	
10A female contacts		
0,14-0,37 mm <sup>2</sup> AWG 26-22 identification No. 1		<b>CDFA 0.3</b>
0,5 mm <sup>2</sup> AWG 20 identification No. 2		<b>CDFA 0.5</b>
0,75 mm <sup>2</sup> AWG 18 identification No. ②		<b>CDFA 0.7</b>
1 mm <sup>2</sup> AWG 18 identification No. 3		<b>CDFA 1.0</b>
1,5 mm <sup>2</sup> AWG 16 identification No. 4		<b>CDFA 1.5</b>
2,5 mm <sup>2</sup> AWG 14 identification No. 5		<b>CDFA 2.5</b>
		silver plated
		<b>CDFD 0.3</b>
		<b>CDFD 0.5</b>
		<b>CDFD 0.7</b>
		<b>CDFD 1.0</b>
		<b>CDFD 1.5</b>
		<b>CDFD 2.5</b>
		gold plated†
10A male contacts		
0,14-0,37 mm <sup>2</sup> AWG 26-22 identification No. 1		<b>CDMA 0.3</b>
0,5 mm <sup>2</sup> AWG 20 identification No. 2		<b>CDMA 0.5</b>
0,75 mm <sup>2</sup> AWG 18 identification No. ②		<b>CDMA 0.7</b>
1 mm <sup>2</sup> AWG 18 identification No. 3		<b>CDMA 1.0</b>
1,5 mm <sup>2</sup> AWG 16 identification No. 4		<b>CDMA 1.5</b>
2,5 mm <sup>2</sup> AWG 14 identification No. 5		<b>CDMA 2.5</b>
		<b>CDMD 0.3</b>
		<b>CDMD 0.5</b>
		<b>CDMD 0.7</b>
		<b>CDMD 1.0</b>
		<b>CDMD 1.5</b>
		<b>CDMD 2.5</b>

- characteristics according to EN 61984:

### 10A 400V 6kV 3

- certified
- insulation resistance: ≥ 10 GΩ
- ambient temperature limit: -40 °C ... +125 °C
- made of self-extinguishing thermoplastic resin UL 94V-0
- mechanical life: ≥ 500 cycles
- contact resistance: ≤ 3 mΩ
- the CQ 07 inserts are already supplied with mounting screw with sealing, which ensures IP66/IP67 degree of protection
- first-make last-break screw-type PE contact
- **it is recommended to crimp the contacts with crimping tools homologated by ILME** (please see the crimping tool section 10A contacts, CDF and CDM series on pages 705 - 741)
- for max. current load see the connector inserts derating diagram below; for more information see page 28

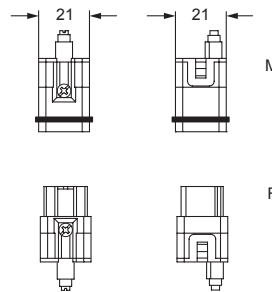

contacts side (front view)

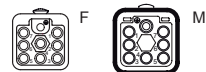

**Note:**  
PE screw connection for unprepared wires only

☑ The **CR QF07** and **CR QM07** coding pins (to be ordered separately), allow the user to create 6 different combinations, according to the diagram shown on **page 690**

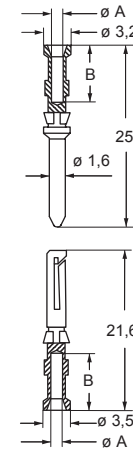

### CDF and CDM contacts

conductor section mm <sup>2</sup>	conductor slot ø A (mm)	conductors stripping length B (mm)
0,14-0,37	0,9	8
0,5	1,1	8
0,75	1,3	8
1,0	1,45	8
1,5	1,8	8
2,5	2,2	6

† for basic or high thickness gold plating, please refer to page 674

### CQ 07 poles connector inserts Maximum current load derating diagram

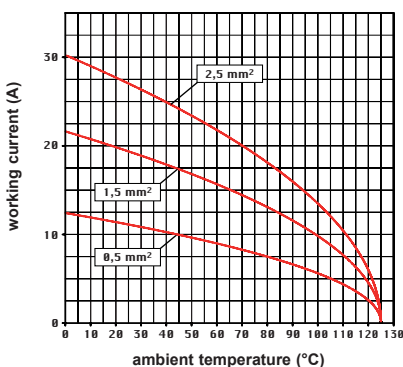

# CQ 12 poles + ⊕ series

## TECHNICAL FEATURES

### Compactness meets performance

Compact solution for high density needs.

Reliable, 16 coding possibilities, perfect for small motors with bridges for star/delta configuration.

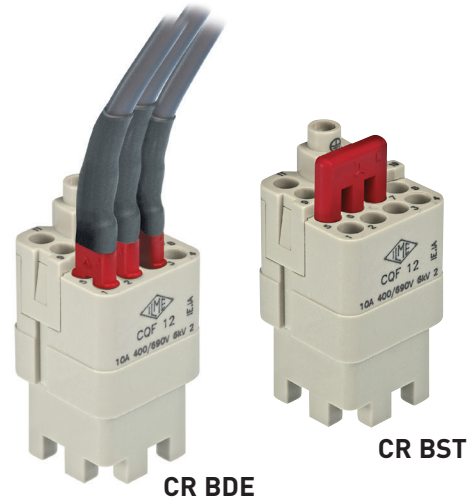

Bridges for delta or star connection  
from page 694, 695

Coding positions for CQ 12 connector  
See following page

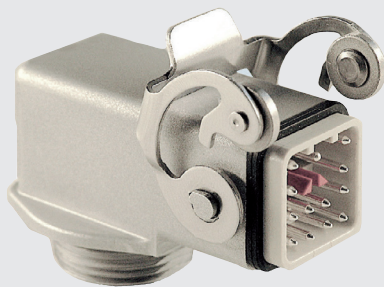

**Legend:**

- ▣ (A B) CQ 12 coding pin
- M = male insert
- F = female insert

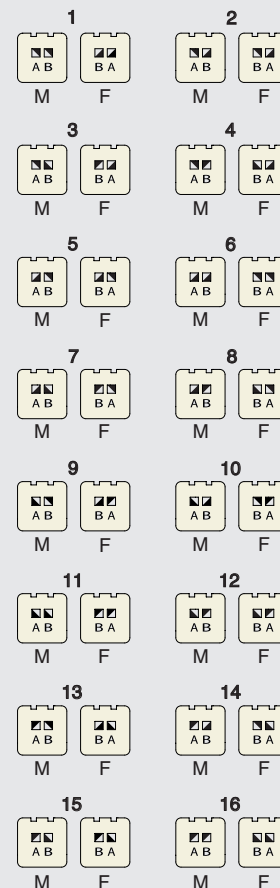



# CQ 12 poles + ⊕ 10A - 400V

enclosures:  
size "21.21"

page:

Insulating type	339 - 348
Metallic type	349 - 363
W-TYPE for aggressive environments	512 - 518
EMC	564 - 572
IP68	628 - 631
E-Xtreme® corrosion proof	538 - 539

ISO 23570-3 standard and  
DESINA, specification  
compliant



## inserts, crimp connections



## 10A crimp contacts silver and gold plated



description	part No.	part No.
without contacts (to be ordered separately)		
female inserts for female contacts	<b>CQF 12</b>	
male inserts for male contacts	<b>CQM 12</b>	
10A female contacts		
0,14-0,37 mm <sup>2</sup> AWG 26-22 identification No. 1		<b>CDFA 0.3</b>
0,5 mm <sup>2</sup> AWG 20 identification No. 2		<b>CDFA 0.5</b>
0,75 mm <sup>2</sup> AWG 18 identification No. ②		<b>CDFA 0.7</b>
1 mm <sup>2</sup> AWG 18 identification No. 3		<b>CDFA 1.0</b>
1,5 mm <sup>2</sup> AWG 16 identification No. 4		<b>CDFA 1.5</b>
2,5 mm <sup>2</sup> AWG 14 identification No. 5		<b>CDFA 2.5</b>
		silver plated
		<b>CDFD 0.3</b>
		<b>CDFD 0.5</b>
		<b>CDFD 0.7</b>
		<b>CDFD 1.0</b>
		<b>CDFD 1.5</b>
		<b>CDFD 2.5</b>
		gold plated†
10A male contacts		
0,14-0,37 mm <sup>2</sup> AWG 26-22 identification No. 1		<b>CDMA 0.3</b>
0,5 mm <sup>2</sup> AWG 20 identification No. 2		<b>CDMA 0.5</b>
0,75 mm <sup>2</sup> AWG 18 identification No. ②		<b>CDMA 0.7</b>
1 mm <sup>2</sup> AWG 18 identification No. 3		<b>CDMA 1.0</b>
1,5 mm <sup>2</sup> AWG 16 identification No. 4		<b>CDMA 1.5</b>
2,5 mm <sup>2</sup> AWG 14 identification No. 5		<b>CDMA 2.5</b>
		<b>CDMD 0.3</b>
		<b>CDMD 0.5</b>
		<b>CDMD 0.7</b>
		<b>CDMD 1.0</b>
		<b>CDMD 1.5</b>
		<b>CDMD 2.5</b>

- characteristics according to EN 61984:

**10A 400V 6kV 3**  
**10A 400/690V 6kV 2**

- cULus (UL for USA and Canada),

- certified

- rated voltage according to UL/CSA: 600V

- insulation resistance: ≥ 10 GΩ

- ambient temperature limit: -40 °C ... +125 °C

- made of self-extinguishing thermoplastic resin UL 94V-0

- mechanical life: ≥ 500 cycles

- contact resistance: ≤ 3 mΩ

- the CQ 12 inserts are already supplied with a seal and a screw, which ensure IP66/IP67 protection rating

- **it is recommended to crimp the contacts with crimping tools homologated by ILME** (please see the crimping tool section 10A contacts, CDF and CDM series on pages 705 - 741)

- for max. current load see the connector inserts derating diagram below; for more information see page 28

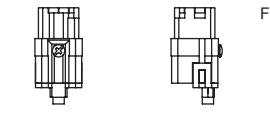
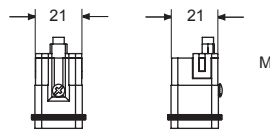

contacts side (front view)

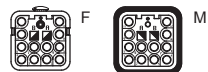

**Note:**  
PE screw connection for unprepared wires only

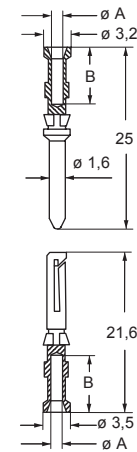

### CDF and CDM contacts

conductor section mm <sup>2</sup>	conductor slot ø A (mm)	conductors stripping length B (mm)
0,14-0,37	0,9	8
0,5	1,1	8
0,75	1,3	8
1,0	1,45	8
1,5	1,8	8
2,5	2,2	6

**CQ 12 poles connector inserts**  
**Maximum current load derating diagram**

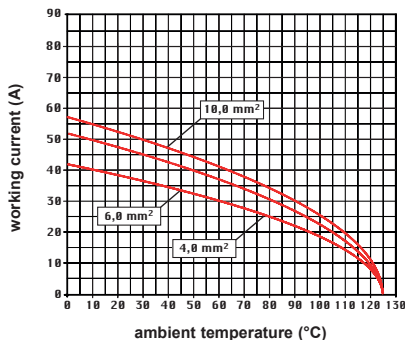

■ The **CR Q12** coding pins (to be ordered separately), allow the user to create 16 different combinations, according to the diagram shown on **page 689**



† for basic or high thickness gold plating, please refer to page 674

# CQ 21 poles 6,5A - 50V ac / 120V dc

enclosures: size "21.21"	page:
Insulating type	339 - 348
Metallic type	349 - 363
W-TYPE for aggressive environments	512 - 518
EMC	564 - 572
IP68	628 - 631
E-Xtreme® corrosion proof	538 - 539

inserts, crimp connections



CI crimp contacts  
silver and gold plated



description	part No.	part No.
-------------	----------	----------

without contacts (to be ordered separately)  
female inserts for female contacts  
male inserts for male contacts

**CQF 21**  
**CQM 21**

CI female crimp contacts  
0,08-0,21 mm<sup>2</sup> AWG 28-24  
0,13-0,33 mm<sup>2</sup> AWG 26-22  
0,33-0,52 mm<sup>2</sup> AWG 22-20

**CIFA 0.2**  
**CIFA 0.3**  
**CIFA 0.5**

silver plated

**CIFD 0.2**  
**CIFD 0.3**  
**CIFD 0.5**

gold plated

CI male crimp contacts  
0,08-0,21 mm<sup>2</sup> AWG 28-24  
0,13-0,33 mm<sup>2</sup> AWG 26-22  
0,33-0,52 mm<sup>2</sup> AWG 22-20

**CIMA 0.2**  
**CIMA 0.3**  
**CIMA 0.5**

**CIMD 0.2**  
**CIMD 0.3**  
**CIMD 0.5**

- characteristics according to EN 61984:  
**6,5A 50V ac / 120V dc 0,8kV 3**
- certified
- insulation resistance:  $\geq 10 \text{ G}\Omega$
- ambient temperature limit: -40 °C ... +125 °C
- made of self-extinguishing thermoplastic resin UL 94V-0
- mechanical life:  $\geq 500$  cycles
- contact resistance:  $\leq 4 \text{ m}\Omega$
- seat of contact #9 on both inserts set forward to obtain pre-leading contact (e.g. for FE functional earth)
- for crimp contacts CI series use, see page 716 - 719
- CIPZ D** crimping tool
- CITP D** turret head
- CIES** insertion / removal tool
- for max. current load see the connector inserts derating diagram below; for more information see page 28

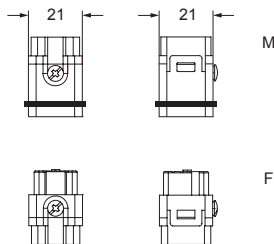

contacts side (front view)

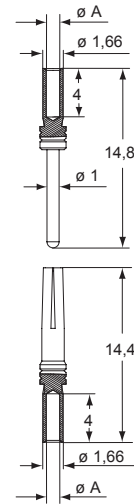

**CIF and CIM contacts**

conductor section mm <sup>2</sup>	conductor slot ø A (mm)	conductors stripping length (mm)
0,08-0,21	0,64	4
0,13-0,33	0,90	4
0,33-0,52	1,12	4

max insulation diameter: 1,7 mm

**CQ 21 poles connector inserts**  
**Maximum current load derating diagram**

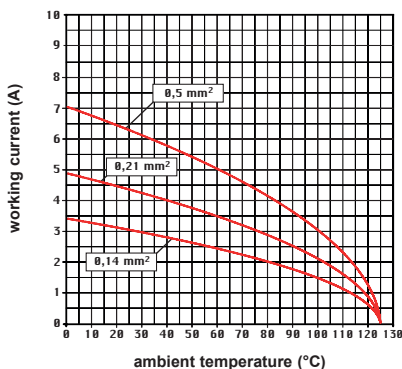

# CQ 4 poles (40A - 400/690V) + 2 poles (10A - 250V) + ⊕

enclosures:  
size "32.13"

page:

insulating type  
EMC

365 - 367  
573 - 574

ISO 23570-3 standard and  
DESINA, specification  
compliant



## inserts, crimp connections

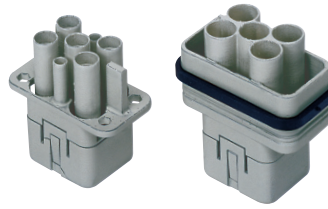

## 40A and 10A crimp contacts silver and gold plated



description	part No.	part No.
-------------	----------	----------

without contacts (to be ordered separately)  
female inserts for female contacts  
male inserts for male contacts

**CQF 04/2**  
**CQM 04/2**

40A female crimp contacts  
1,5 mm<sup>2</sup> AWG 16  
2,5 mm<sup>2</sup> AWG 14  
4 mm<sup>2</sup> AWG 12  
6 mm<sup>2</sup> AWG 10

**CXFA 1.5**  
**CXFA 2.5**  
**CXFA 4.0**  
**CXFA 6.0**

silver plated

40A male crimp contacts  
1,5 mm<sup>2</sup> AWG 16  
2,5 mm<sup>2</sup> AWG 14  
4 mm<sup>2</sup> AWG 12  
6 mm<sup>2</sup> AWG 10

**CXMA 1.5**  
**CXMA 2.5**  
**CXMA 4.0**  
**CXMA 6.0**

+ for basic or high thickness gold plating, please refer to page 674

10A female contacts  
0,14-0,37 mm<sup>2</sup> AWG 26-22 identification No. 1  
0,5 mm<sup>2</sup> AWG 20 identification No. 2  
0,75 mm<sup>2</sup> AWG 18 identification No. ②  
1 mm<sup>2</sup> AWG 18 identification No. 3  
1,5 mm<sup>2</sup> AWG 16 identification No. 4  
2,5 mm<sup>2</sup> AWG 14 identification No. 5

**CDFA 0.3**  
**CDFA 0.5**  
**CDFA 0.7**  
**CDFA 1.0**  
**CDFA 1.5**  
**CDFA 2.5**

**CDFD 0.3**  
**CDFD 0.5**  
**CDFD 0.7**  
**CDFD 1.0**  
**CDFD 1.5**  
**CDFD 2.5**

gold plated+\*

10A male contacts  
0,14-0,37 mm<sup>2</sup> AWG 26-22 identification No. 1  
0,5 mm<sup>2</sup> AWG 20 identification No. 2  
0,75 mm<sup>2</sup> AWG 18 identification No. ②  
1 mm<sup>2</sup> AWG 18 identification No. 3  
1,5 mm<sup>2</sup> AWG 16 identification No. 4  
2,5 mm<sup>2</sup> AWG 14 identification No. 5

**CDMA 0.3**  
**CDMA 0.5**  
**CDMA 0.7**  
**CDMA 1.0**  
**CDMA 1.5**  
**CDMA 2.5**

**CDMD 0.3**  
**CDMD 0.5**  
**CDMD 0.7**  
**CDMD 1.0**  
**CDMD 1.5**  
**CDMD 2.5**

- characteristics according to EN 61984:
- 4 poles 40A 400/690V 6kV 3**
- 2 poles 10A 250V 4kV 3**
- cULus (UL for USA and Canada),
- BUREAU VERITAS ERI certified
- rated voltage according to UL/CSA: 600V
- insulation resistance: ≥ 10 GΩ
- ambient temperature limit: -40 °C ... +125 °C
- made of self-extinguishing thermoplastic resin UL 94V-0
- mechanical life: ≥ 500 cycles
- contact resistance: ≤ 0,3 mΩ (4 poles), ≤ 3 mΩ (2 poles)
- for max. current load see the connector inserts derating diagram below; for more information see page 28

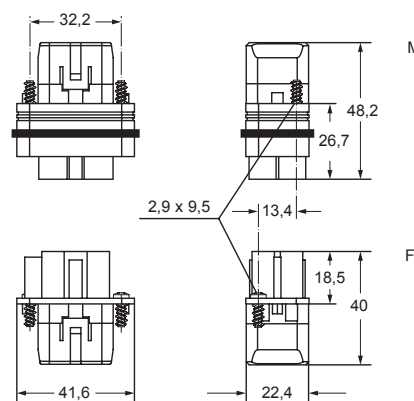

contacts side (front view)

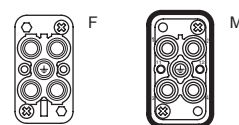

- each insert supplied with 2 fixing screws, self-tapping, zinc plated steel Ø2,9x9,5 mm, Ph1
- it is recommended to crimp the contacts with crimping tools homologated by ILME (please see the crimping tool section 40A contacts, CXF, CXM series and 10A contacts CDF, CDM series on pages 705 - 741)

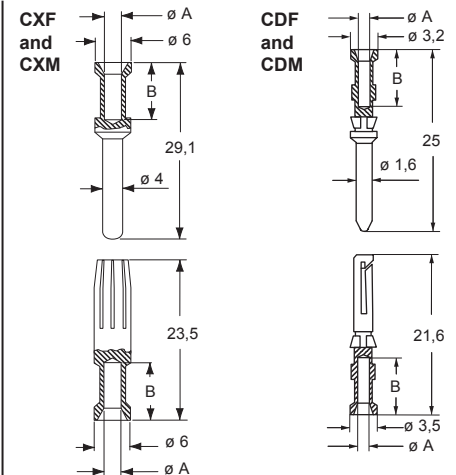

### CXF and CXM contacts

conductor section mm <sup>2</sup>	conductor slot ø A (mm)	conductors stripping length B (mm)
1,5	1,8	9
2,5	2,2	9
4	2,85	9,6
6	3,5	9,6

### CDF and CDM contacts

0,14-0,37	0,9	8
0,5	1,1	8
0,75	1,3	8
1,0	1,45	8
1,5	1,8	8
2,5	2,2	6

**CQ 04/2 power poles connector inserts**  
Maximum current load derating diagram

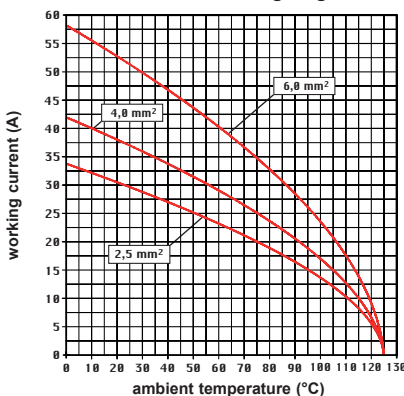

# CQ 8 poles + ⊕ 16A - 500V

enclosures:  
size "32.13"

page:

insulating type  
EMC

365 - 367  
573 - 574

- can also be used partially fitted with 4 mm<sup>2</sup> section contacts

ISO 23570-3 standard and  
DESINA. specification  
compliant



## inserts, crimp connections

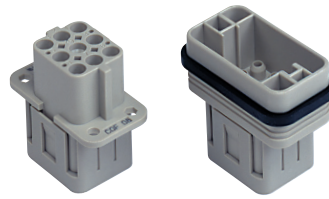

## 16A crimp contacts standard or for advanced opening silver and gold plated



STANDARD

ADVANCED OPENING

description

part No.

part No.

without contacts (to be ordered separately)  
female inserts for female contacts  
male inserts for male contacts

**CQF 08**  
**CQM 08**

### 16A female contacts

0,14-0,37 mm <sup>2</sup>	AWG 26-22	one groove
0,5 mm <sup>2</sup>	AWG 20	with no grooves
0,75 mm <sup>2</sup>	AWG 18	one groove (back side)
1 mm <sup>2</sup>	AWG 18	one groove
1,5 mm <sup>2</sup>	AWG 16	two grooves
2,5 mm <sup>2</sup>	AWG 14	three grooves
3 mm <sup>2</sup>	AWG 12	one wide groove
4 mm <sup>2</sup>	AWG 12	with no grooves

### 16A male contacts

0,14-0,37 mm <sup>2</sup>	AWG 26-22	one groove
0,5 mm <sup>2</sup>	AWG 20	with no grooves
0,75 mm <sup>2</sup>	AWG 18	one groove (back side)
1 mm <sup>2</sup>	AWG 18	one groove
1,5 mm <sup>2</sup>	AWG 16t	wo grooves
2,5 mm <sup>2</sup>	AWG 14	three grooves
3 mm <sup>2</sup>	AWG 12	one wide groove
4 mm <sup>2</sup>	AWG 12	with no grooves

### 16A male crimp contacts for advanced opening

0,5 mm <sup>2</sup>	AWG 20	with no grooves
0,75 mm <sup>2</sup>	AWG 18	one groove (back side)
1 mm <sup>2</sup>	AWG 18	one groove
1,5 mm <sup>2</sup>	AWG 16	two grooves
2,5 mm <sup>2</sup>	AWG 14	three grooves

**CCFA 0.3**  
**CCFA 0.5**  
**CCFA 0.7**  
**CCFA 1.0**  
**CCFA 1.5**  
**CCFA 2.5**  
**CCFA 3.0**  
**CCFA 4.0**

silver plated

**CCFD 0.3**  
**CCFD 0.5**  
**CCFD 0.7**  
**CCFD 1.0**  
**CCFD 1.5**  
**CCFD 2.5**  
**CCFD 3.0**  
**CCFD 4.0**

gold plated<sup>+</sup>

**CCMA 0.3**  
**CCMA 0.5**  
**CCMA 0.7**  
**CCMA 1.0**  
**CCMA 1.5**  
**CCMA 2.5**  
**CCMA 3.0**  
**CCMA 4.0**

**CCMD 0.3**  
**CCMD 0.5**  
**CCMD 0.7**  
**CCMD 1.0**  
**CCMD 1.5**  
**CCMD 2.5**  
**CCMD 3.0**  
**CCMD 4.0**

**CC 0.5 AN**  
**CC 0.7 AN**  
**CC 1.0 AN**  
**CC 1.5 AN**  
**CC 2.5 AN**

+ for basic or high thickness gold plating, please refer to page 675

- characteristics according to EN 61984:

**16A 500V 6kV 3**  
**16A 400/690V 8kV 2**

- cULus (UL for USA and Canada),

- BUREAU VERITAS ERI certified
- rated voltage according to UL/CSA: 600V
- insulation resistance: ≥ 10 GΩ
- ambient temperature limit: -40 °C ... +125 °C
- made of self-extinguishing thermoplastic resin UL 94V-0
- mechanical life: ≥ 500 cycles
- contact resistance: ≤ 3 mΩ
- for max. current load see the connector inserts derating diagram below; for more information see page 28

**CQ 08 poles connector inserts**  
Maximum current load derating diagram

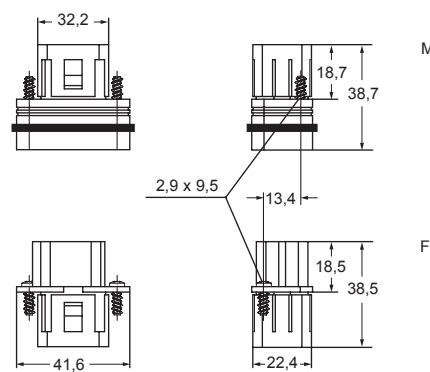
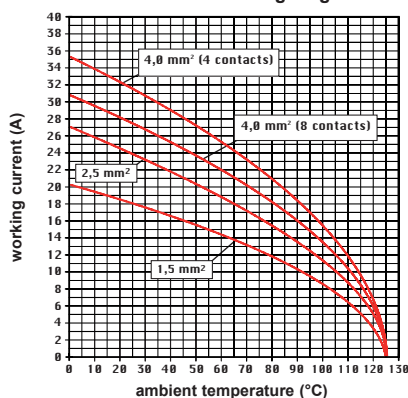

contacts side (front view)

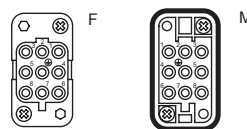

- each insert supplied with 2 fixing screws, self-tapping, zinc plated steel Ø2,9x9,5 mm, Ph1
- it is recommended to crimp the contacts with crimping tools homologated by ILME (please see the crimping tool section 16A contacts, CCF, CCM and CC...AN series on pages 705 - 741)

## CCF and CCM

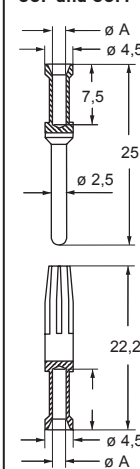

## CC...AN

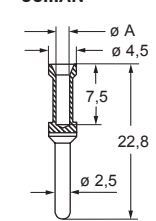

## CCF, CCM and CC...AN contacts

conductor section mm <sup>2</sup>	conductor slot Ø A (mm)	conductors stripping length (mm)
0,14-0,37	0,9	7,5
0,5	1,1	7,5
0,75	1,3	7,5
1,0	1,45	7,5
1,5	1,8	7,5
2,5	2,2	7,5
3	2,55	7,5
4	2,85	7,5

# CQ 17 poles + ⊕ 10A - 160V

enclosures:  
size "32.13"

page:

insulating type  
EMC

365 - 367  
573 - 574

## inserts, crimp connections

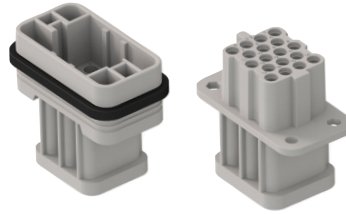

## 10A crimp contacts silver and gold plated



description	part No.	part No.
without contacts (to be ordered separately)		
female inserts for female contacts	<b>CQF 17</b>	
male inserts for male contacts	<b>CQM 17</b>	
<b>10A female contacts</b>		
0,14-0,37 mm <sup>2</sup> AWG 26-22 identification No. 1		<b>CDFA 0.3</b>
0,5 mm <sup>2</sup> AWG 20 identification No. 2		<b>CDFA 0.5</b>
0,75 mm <sup>2</sup> AWG 18 identification No. ②		<b>CDFA 0.7</b>
1 mm <sup>2</sup> AWG 18 identification No. 3		<b>CDFA 1.0</b>
1,5 mm <sup>2</sup> AWG 16 identification No. 4		<b>CDFA 1.5</b>
2,5 mm <sup>2</sup> AWG 14 identification No. 5		<b>CDFA 2.5</b>
		<b>silver plated</b>
		<b>CDFD 0.3</b>
		<b>CDFD 0.5</b>
		<b>CDFD 0.7</b>
		<b>CDFD 1.0</b>
		<b>CDFD 1.5</b>
		<b>CDFD 2.5</b>
		<b>gold plated†</b>
<b>10A male contacts</b>		
0,14-0,37 mm <sup>2</sup> AWG 26-22 identification No. 1		<b>CDMA 0.3</b>
0,5 mm <sup>2</sup> AWG 20 identification No. 2		<b>CDMA 0.5</b>
0,75 mm <sup>2</sup> AWG 18 identification No. ②		<b>CDMA 0.7</b>
1 mm <sup>2</sup> AWG 18 identification No. 3		<b>CDMA 1.0</b>
1,5 mm <sup>2</sup> AWG 16 identification No. 4		<b>CDMA 1.5</b>
2,5 mm <sup>2</sup> AWG 14 identification No. 5		<b>CDMA 2.5</b>
		<b>CDMD 0.3</b>
		<b>CDMD 0.5</b>
		<b>CDMD 0.7</b>
		<b>CDMD 1.0</b>
		<b>CDMD 1.5</b>
		<b>CDMD 2.5</b>

- characteristics according to EN 61984:

**10A 160V 2,5kV 3**  
**10A 250V 4kV 2**

- DNV-GL VERITAS EAC certified
- insulation resistance:  $\geq 10 \text{ G}\Omega$
- ambient temperature limit:  $-40 \text{ }^\circ\text{C} \dots +125 \text{ }^\circ\text{C}$
- made of self-extinguishing thermoplastic resin UL 94V-0
- mechanical life:  $\geq 500$  cycles
- contact resistance:  $\leq 3 \text{ m}\Omega$
- seat of PE contact on female insert set forward to obtain pre-leading PE
- each insert supplied with 2 fixing screws, self-tapping, zinc plated steel  $\text{Ø}2,9 \times 9,5 \text{ mm}$ , Ph1
- **it is recommended to crimp the contacts with crimping tools homologated by ILME** (please see the crimping tool section 10A contacts, CDF and CDM series on pages 705 - 741)
- for max. current load see the connector inserts derating diagram below; for more information see page 28

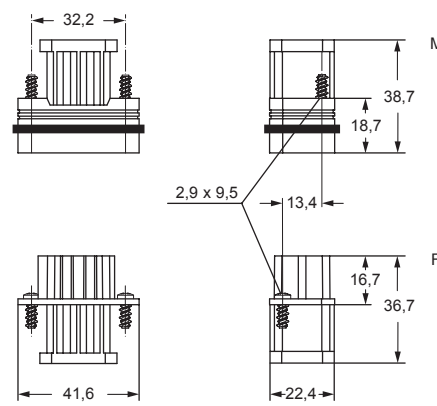

contacts side (front view)

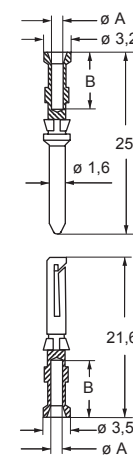
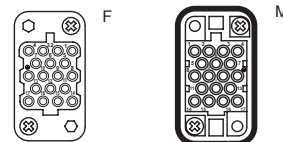

### CDF and CDM contacts

conductor section mm <sup>2</sup>	conductor slot Ø A (mm)	conductors stripping length B (mm)
0,14-0,37	0,9	8
0,5	1,1	8
0,75	1,3	8
1,0	1,45	8
1,5	1,8	8
2,5	2,2	6

**CQ 17 poles connector inserts**  
**Maximum current load derating diagram**

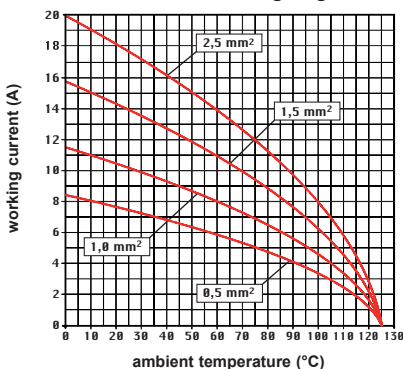

CR CP coding pin  
with loss of one contact  
(page 689)



† for basic or high thickness gold plating, please refer to page 674

# CX 8 poles (16A - 400V) + 24 poles (10A - 250V) + ⊕

enclosures: size "57.27"	page:
C-TYPE IP65/IP66	393 - 401
C7 IP67, two levers	438
V-TYPE IP65/IP66, single lever	448 - 453
BIG hoods	468 - 469
T-TYPE IP65 insulating	482 - 483
T-TYPE / W IP66 insulating	490
HYGIENIC T-TYPE / H IP66/IP69	502
HYGIENIC T-TYPE / C IP66/IP69, -50 °C	507
W-TYPE for aggressive environments	522
E-Xtreme® corrosion proof	532 - 533, 543, 552 - 553
EMC	579
Central lever	606 - 608
LS-TYPE	620 - 621
IP68	636 - 639
panel supports: COB	page: 652 - 653

inserts, crimp connections

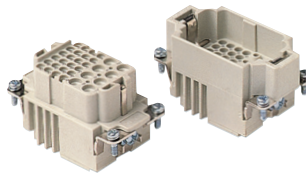

description	part No.
-------------	----------

without contacts (to be ordered separately)  
female inserts for female contacts  
male inserts for male contacts

CXF 8/24  
CXM 8/24

- characteristics according to EN 61984:
- 16A 230/400V 4kV 3**
- 10A 400V 4kV 2**
- 10A 160V 2,5kV 3**
- 10A 250V 4kV 2**
- certified
- rated voltage according to UL/CSA: 600V
- insulation resistance: ≥ 10 GΩ
- ambient temperature limit: -40 °C ... +125 °C
- made of self-extinguishing thermoplastic resin UL 94V-0
- mechanical life: ≥ 500 cycles
- contact resistance:
  - ≤ 1 mΩ (8 poles)
  - ≤ 3 mΩ (24 poles)
- **it is recommended to crimp the contacts with crimping tools homologated by ILME**  
(please see the crimping tool section 16A contacts, CCF, CCM, CC...AN series and 10A contacts CDF, CDM series on pages 705 - 741)
- PCBs interface, see article CIF 2.4 (10A contacts)
- for max. current load see the connector inserts derating diagrams below; for more information see page 28

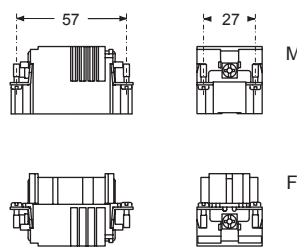

contacts side (front view)

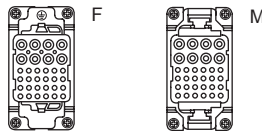

CX 8/24 power poles connector inserts  
Maximum current load derating diagram

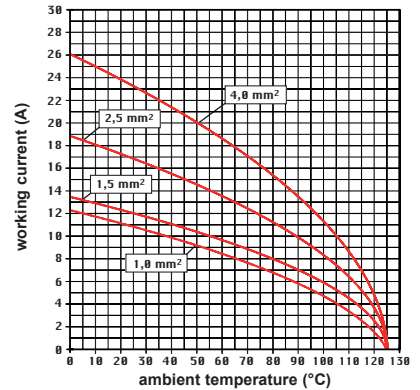

CX 8/24 auxiliary poles connector inserts  
Maximum current load derating diagram

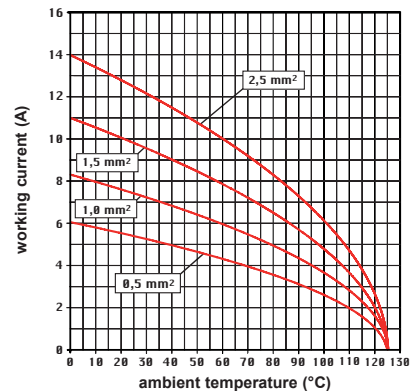

**Note:** for connector with power poles and auxiliary poles simultaneously loaded in the combinations

power poles	auxiliary poles
4,0 mm <sup>2</sup>	2,5 mm <sup>2</sup>
2,5 mm <sup>2</sup>	1,5 mm <sup>2</sup>
1,5 mm <sup>2</sup>	1,0 mm <sup>2</sup>
1,0 mm <sup>2</sup>	0,5 mm <sup>2</sup>

with power / auxiliary current ratios = 1,6 / 1

CX 8/24



### 16A crimp contacts standard or for advanced opening silver and gold plated

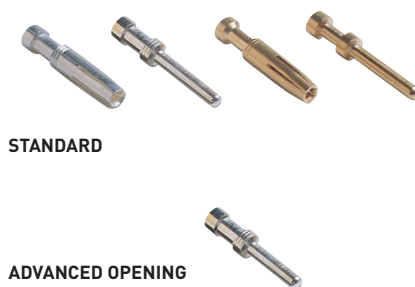

STANDARD

ADVANCED OPENING

### 10A crimp contacts silver and gold plated



description			part No.		part No.	
<b>16A female contacts</b>						
0,14-0,37 mm <sup>2</sup>	AWG 26-22	one groove	<b>CCFA 0.3</b>	silver plated	<b>CCFD 0.3</b>	
0,5 mm <sup>2</sup>	AWG 20	with no grooves	<b>CCFA 0.5</b>		<b>CCFD 0.5</b>	
0,75 mm <sup>2</sup>	AWG 18	one groove (back side)	<b>CCFA 0.7</b>		<b>CCFD 0.7</b>	
1 mm <sup>2</sup>	AWG 18	one groove	<b>CCFA 1.0</b>		<b>CCFD 1.0</b>	
1,5 mm <sup>2</sup>	AWG 16	two grooves	<b>CCFA 1.5</b>		<b>CCFD 1.5</b>	
2,5 mm <sup>2</sup>	AWG 14	three grooves	<b>CCFA 2.5</b>		<b>CCFD 2.5</b>	
3 mm <sup>2</sup>	AWG 12	one wide groove	<b>CCFA 3.0</b>		<b>CCFD 3.0</b>	
4 mm <sup>2</sup>	AWG 12	with no grooves	<b>CCFA 4.0</b>		<b>CCFD 4.0</b>	
<b>16A male contacts</b>						
0,14-0,37 mm <sup>2</sup>	AWG 26-22	one groove	<b>CCMA 0.3</b>		gold plated <sup>+</sup>	<b>CCMD 0.3</b>
0,5 mm <sup>2</sup>	AWG 20	with no grooves	<b>CCMA 0.5</b>	<b>CCMD 0.5</b>		
0,75 mm <sup>2</sup>	AWG 18	one groove (back side)	<b>CCMA 0.7</b>	<b>CCMD 0.7</b>		
1 mm <sup>2</sup>	AWG 18	one groove	<b>CCMA 1.0</b>	<b>CCMD 1.0</b>		
1,5 mm <sup>2</sup>	AWG 16t	wo grooves	<b>CCMA 1.5</b>	<b>CCMD 1.5</b>		
2,5 mm <sup>2</sup>	AWG 14	three grooves	<b>CCMA 2.5</b>	<b>CCMD 2.5</b>		
3 mm <sup>2</sup>	AWG 12	one wide groove	<b>CCMA 3.0</b>	<b>CCMD 3.0</b>		
4 mm <sup>2</sup>	AWG 12	with no grooves	<b>CCMA 4.0</b>	<b>CCMD 4.0</b>		
<b>16A male crimp contacts for advanced opening</b>						
0,5 mm <sup>2</sup>	AWG 20	with no grooves	<b>CC 0.5 AN</b>			
0,75 mm <sup>2</sup>	AWG 18	one groove (back side)	<b>CC 0.7 AN</b>			
1 mm <sup>2</sup>	AWG 18	one groove	<b>CC 1.0 AN</b>			
1,5 mm <sup>2</sup>	AWG 16	two grooves	<b>CC 1.5 AN</b>			
2,5 mm <sup>2</sup>	AWG 14	three grooves	<b>CC 2.5 AN</b>			
<b>10A female contacts</b>						
0,14-0,37 mm <sup>2</sup>	AWG 26-22	identification No. 1		silver plated	<b>CDFA 0.3</b>	
0,5 mm <sup>2</sup>	AWG 20	identification No. 2			<b>CDFA 0.5</b>	
0,75 mm <sup>2</sup>	AWG 18	identification No. ②			<b>CDFA 0.7</b>	
1 mm <sup>2</sup>	AWG 18	identification No. 3			<b>CDFA 1.0</b>	
1,5 mm <sup>2</sup>	AWG 16	identification No. 4			<b>CDFA 1.5</b>	
2,5 mm <sup>2</sup>	AWG 14	identification No. 5			<b>CDFA 2.5</b>	
<b>10A male contacts</b>						
0,14-0,37 mm <sup>2</sup>	AWG 26-22	identification No. 1		gold plated <sup>+</sup>	<b>CDMA 0.3</b>	
0,5 mm <sup>2</sup>	AWG 20	identification No. 2			<b>CDMA 0.5</b>	
0,75 mm <sup>2</sup>	AWG 18	identification No. ②			<b>CDMA 0.7</b>	
1 mm <sup>2</sup>	AWG 18	identification No. 3			<b>CDMA 1.0</b>	
1,5 mm <sup>2</sup>	AWG 16	identification No. 4			<b>CDMA 1.5</b>	
2,5 mm <sup>2</sup>	AWG 14	identification No. 5			<b>CDMA 2.5</b>	

#### CCF, CCM and CC..AN contacts

conductor section mm <sup>2</sup>	conductor slot $\varnothing A$ (mm)	conductors stripping length (mm)
0,14-0,37	0,9	7,5
0,5	1,1	7,5
0,75	1,3	7,5
1,0	1,45	7,5
1,5	1,8	7,5
2,5	2,2	7,5
3	2,55	7,5
4	2,85	7,5

#### CDF and CDM contacts

conductor section mm <sup>2</sup>	conductor slot $\varnothing A$ (mm)	conductors stripping length B (mm)
0,14-0,37	0,9	8
0,5	1,1	8
0,75	1,3	8
1,0	1,45	8
1,5	1,8	8
2,5	2,2	6

#### CCF and CCM

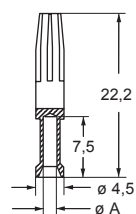
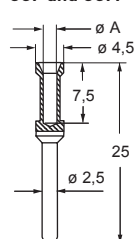

#### CC...AN

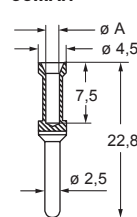

\* for basic or high thickness gold plating, please refer to page 675

#### CDF and CDM

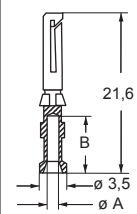
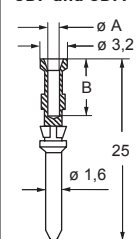

\* for basic or high thickness gold plating, please refer to page 674

## Inserts with a retainer device on crimp contacts

**CX 6/12 insert** has been developed **with a retainer device on crimp contacts**.

This layout enables the wires to be connected to the socket and plug insert removable contacts by crimping them with a crimp tool and its locating turret.

The crimp connection is insured and is **extremely resistant even to the most insidious strains**, such as vibrations.

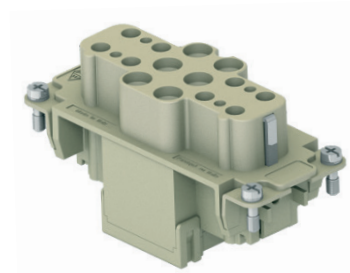

### SUM-UP

- ☑ **Crimp connection**
- ☑ **Great resistance to strong vibrations**
- ☑ **For wires: up to 10 mm<sup>2</sup> (AWG 8)**
- ☑ **Auxiliary crimp contacts: silver or gold plated**

Inserts series		CX 6/12	
No. of poles	main contact	6 + ⊕ (40A)	
	auxiliary contacts	12 (10A)	
rated current		40A	10A
EN 61984 pollution degree 3	rated voltage	690V	230V/400V
	rated impulse withstand voltage	8kV	4kV
	pollution degree	3	3
contact resistance		≤ 0,3 mΩ (40A) ≤ 1 mΩ (16A)	
insulation resistance		≥ 10 GΩ	
ambient temperature limit (°C)	min	-40 °C	
	max	+125 °C	
degree of protection	with enclosures (according to version)	IP65, IP66, IP67, IP68, IP69	
	without enclosures	IP20	
conductor connections		crimp	
conductor cross-section	mm <sup>2</sup>	1,5 ..... 10	
	AWG	16 - 8	
conductor cross-section (CC contact series)	mm <sup>2</sup>	0,14 ..... 2,5	
	AWG	26 - 14	
CX/CC stripping length	mm	8 / 9 / 15	
mechanical endurance (mating cycles)		≥ 500	

# CX 6 poles (40A - 690V) + 12 poles (10A - 230/400V) + ⊕

enclosures: size "77.27"	page:
C-TYPE IP65/IP66	402 - 411
C7 IP67, two levers	439 - 440
V-TYPE IP65/IP66, single lever	454 - 458
BIG hoods	470 - 471
T-TYPE IP65 insulating	484 - 485
T-TYPE / W IP66 insulating	491
HYGIENIC T-TYPE / H IP66/IP69	503
HYGIENIC T-TYPE / C IP66/IP69, -50 °C	508
W-TYPE for aggressive environments	523
E-Xtreme® corrosion proof	534 - 535, 544, 554 - 555
EMC	580
Central lever	609 - 611
LS-TYPE	622 - 623
IP68	640 - 643
panel supports: COB	page: 652 - 653

inserts, crimp connections

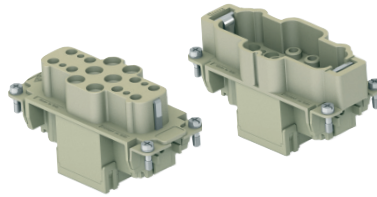

40A and 10A crimp contacts  
silver and gold plated



description	part No.	part No.
without contacts (to be ordered separately)		
female inserts for female contacts	CXF 6/12	
male inserts for male contacts	CXM 6/12	
40A female crimp contacts		CXFA 1.5 CXFA 2.5 CXFA 4.0 CXFA 6.0 CXFA 10
1,5 mm <sup>2</sup> AWG 16		
2,5 mm <sup>2</sup> AWG 14		
4 mm <sup>2</sup> AWG 12		
6 mm <sup>2</sup> AWG 10		
10 mm <sup>2</sup> AWG 8		
40A male crimp contacts		CXMA 1.5 CXMA 2.5 CXMA 4.0 CXMA 6.0 CXMA 10
1,5 mm <sup>2</sup> AWG 16		
2,5 mm <sup>2</sup> AWG 14		
4 mm <sup>2</sup> AWG 12		
6 mm <sup>2</sup> AWG 10		
10 mm <sup>2</sup> AWG 8		
10A female contacts		CDF 0.3 CDF 0.5 CDF 0.7 CDF 1.0 CDF 1.5 CDF 2.5
0,14-0,37 mm <sup>2</sup> AWG 26-22 identification No. 1		
0,5 mm <sup>2</sup> AWG 20 identification No. 2		
0,75 mm <sup>2</sup> AWG 18 identification No. ②		
1 mm <sup>2</sup> AWG 18 identification No. 3		
1,5 mm <sup>2</sup> AWG 16 identification No. 4		
2,5 mm <sup>2</sup> AWG 14 identification No. 5		
10A male contacts		CDMA 0.3 CDMA 0.5 CDMA 0.7 CDMA 1.0 CDMA 1.5 CDMA 2.5
0,14-0,37 mm <sup>2</sup> AWG 26-22 identification No. 1		
0,5 mm <sup>2</sup> AWG 20 identification No. 2		
0,75 mm <sup>2</sup> AWG 18 identification No. ②		
1 mm <sup>2</sup> AWG 18 identification No. 3		
1,5 mm <sup>2</sup> AWG 16 identification No. 4		
2,5 mm <sup>2</sup> AWG 14 identification No. 5		

silver plated

+ for basic or high thickness gold plating, please refer to page 674

gold plated+

- characteristics according to EN 61984:
- 40A 690V 8kV 3**
- 10A 230/400V 4kV 3**
- certified
- insulation resistance: ≥ 10 GΩ
- ambient temperature limit: -40 °C ... +125 °C
- made of self-extinguishing thermoplastic resin UL 94V-0
- mechanical life: ≥ 500 cycles
- contact resistance:
  - ≤ 0,3 mΩ (6 poles)
  - ≤ 1 mΩ (12 poles)
- cable diameter: up to 7,5 mm
- contact section: up to 10 mm<sup>2</sup>
- **it is recommended to crimp the contacts with crimping tools homologated by ILME** (please see the crimping tool section 40A contacts, CXF, CXM series and 10A contacts CDF, CDM series on pages 705 - 741
- for max. current load see the connector inserts derating diagram below; for more information see page 28

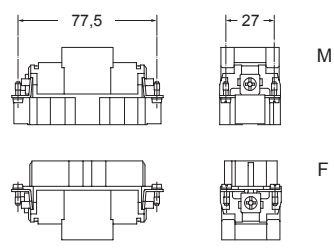

contacts side (front view)

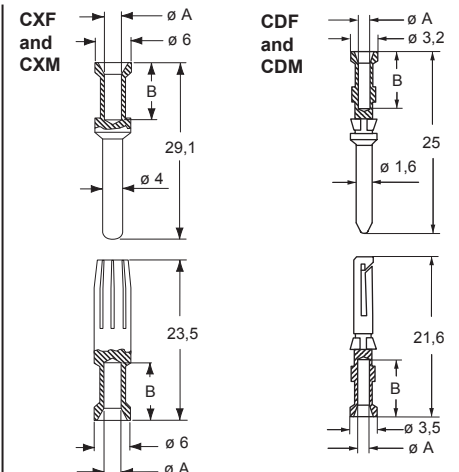
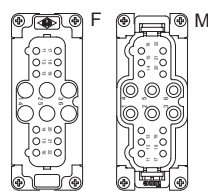

CXF and CXM contacts		
conductor section mm <sup>2</sup>	conductor slot Ø A (mm)	conductors stripping length B (mm)
1,5	1,8	9
2,5	2,2	9
4	2,85	9,6
6	3,5	9,6
10	4,3	15
CDF and CDM contacts		
0,14-0,37	0,9	8
0,5	1,1	8
0,75	1,3	8
1,0	1,45	8
1,5	1,8	8
2,5	2,2	6

CX 6/12 power poles connector inserts  
Maximum current load derating diagram

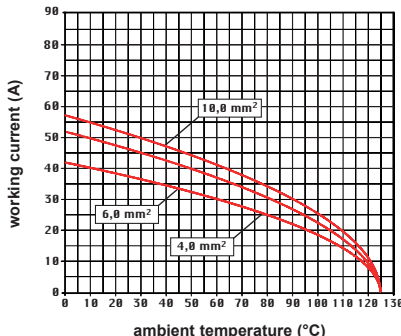

# CX 6 poles (40A - 690V) + 36 poles (10A - 250V) + ⊕

enclosures: size "77.27"	page:
C-TYPE IP65/IP66	402 - 411
C7 IP67, two levers	439 - 440
V-TYPE IP65/IP66, single lever	454 - 458
BIG hoods	470 - 471
T-TYPE IP65 insulating	484 - 485
T-TYPE / W IP66 insulating	491
HYGIENIC T-TYPE / H IP66/IP69	503
HYGIENIC T-TYPE / C IP66/IP69, -50 °C	508
W-TYPE for aggressive environments	523
E-Xtreme® corrosion proof	534 - 535, 544, 554 - 555
EMC	580
Central lever	609 - 611
LS-TYPE	622 - 623
IP68	640 - 643

panel supports: COB	page: 652 - 653
------------------------	--------------------

- PCBs interface, see article CIF 2.4 (10A contacts)

## inserts, crimp connections

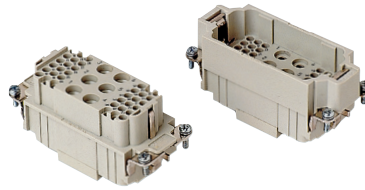

## 40A and 10A crimp contacts silver and gold plated



description	part No.	part No.
-------------	----------	----------

without contacts (to be ordered separately)		
female inserts for female contacts	<b>CXF 6/36</b>	
male inserts for male contacts	<b>CXM 6/36</b>	

40A female crimp contacts			
1,5 mm <sup>2</sup> AWG 16		<b>CXFA 1.5</b>	silver plated
2,5 mm <sup>2</sup> AWG 14		<b>CXFA 2.5</b>	
4 mm <sup>2</sup> AWG 12		<b>CXFA 4.0</b>	
6 mm <sup>2</sup> AWG 10		<b>CXFA 6.0</b>	
40A male crimp contacts			
1,5 mm <sup>2</sup> AWG 16		<b>CXMA 1.5</b>	silver plated
2,5 mm <sup>2</sup> AWG 14		<b>CXMA 2.5</b>	
4 mm <sup>2</sup> AWG 12		<b>CXMA 4.0</b>	
6 mm <sup>2</sup> AWG 10		<b>CXMA 6.0</b>	

+ for basic or high thickness gold plating, please refer to page 674

10A female contacts					
0,14-0,37 mm <sup>2</sup> AWG 26-22	identification No. 1	<b>CDFA 0.3</b>	gold plated+	<b>CDFD 0.3</b>	
0,5 mm <sup>2</sup> AWG 20	identification No. 2	<b>CDFA 0.5</b>		<b>CDFD 0.5</b>	
0,75 mm <sup>2</sup> AWG 18	identification No. ②	<b>CDFA 0.7</b>		<b>CDFD 0.7</b>	
1 mm <sup>2</sup> AWG 18	identification No. 3	<b>CDFA 1.0</b>		<b>CDFD 1.0</b>	
1,5 mm <sup>2</sup> AWG 16	identification No. 4	<b>CDFA 1.5</b>		<b>CDFD 1.5</b>	
2,5 mm <sup>2</sup> AWG 14	identification No. 5	<b>CDFA 2.5</b>		<b>CDFD 2.5</b>	
10A male contacts					
0,14-0,37 mm <sup>2</sup> AWG 26-22	identification No. 1	<b>CDMA 0.3</b>		<b>CDMD 0.3</b>	
0,5 mm <sup>2</sup> AWG 20	identification No. 2	<b>CDMA 0.5</b>		<b>CDMD 0.5</b>	
0,75 mm <sup>2</sup> AWG 18	identification No. ②	<b>CDMA 0.7</b>		<b>CDMD 0.7</b>	
1 mm <sup>2</sup> AWG 18	identification No. 3	<b>CDMA 1.0</b>	<b>CDMD 1.0</b>		
1,5 mm <sup>2</sup> AWG 16	identification No. 4	<b>CDMA 1.5</b>	<b>CDMD 1.5</b>		
2,5 mm <sup>2</sup> AWG 14	identification No. 5	<b>CDMA 2.5</b>	<b>CDMD 2.5</b>		

- characteristics according to EN 61984:
- 40A 690V 8kV 3**
- 10A 160V 2,5kV 3**
- 10A 250V 4kV 2**
- certified
- rated voltage according to UL/CSA: 600V
- insulation resistance: ≥ 10 GΩ
- ambient temperature limit: -40 °C ... +125 °C
- made of self-extinguishing thermoplastic resin UL 94V-0
- mechanical life: ≥ 500 cycles
- contact resistance: ≤ 0,3 mΩ (6 poles), ≤ 1 mΩ (36 poles)
- for max. current load see the connector inserts derating diagram below; for more information see page 28

**CX 6/36 power poles connector inserts**  
Maximum current load derating diagram

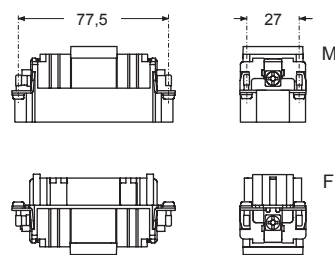
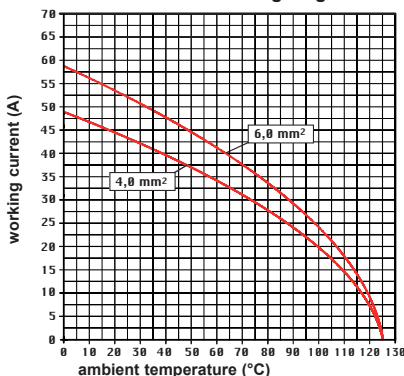

contacts side (front view)

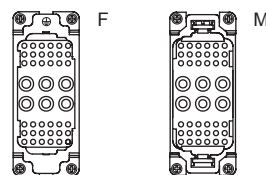

- it is recommended to crimp the contacts with crimping tools homologated by ILME (please see the crimping tool section 40A contacts, CXF, CXM series and 10A contacts CDF, CDM series on pages 705 - 741

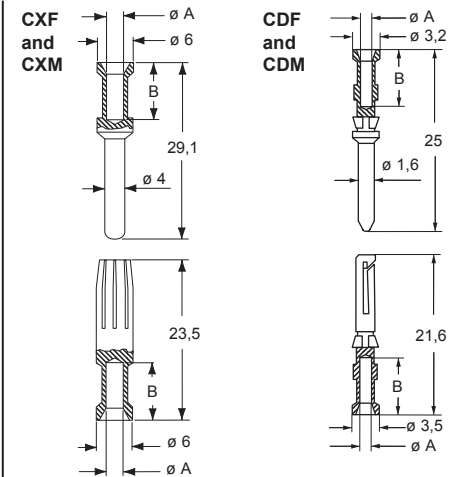

CXF and CXM contacts		
conductor section mm <sup>2</sup>	conductor slot Ø A (mm)	conductors stripping length B (mm)
1,5	1,8	9
2,5	2,2	9
4	2,85	9,6
6	3,5	9,6

CDF and CDM contacts		
conductor section mm <sup>2</sup>	conductor slot Ø A (mm)	conductors stripping length B (mm)
0,14-0,37	0,9	8
0,5	1,1	8
0,75	1,3	8
1,0	1,45	8
1,5	1,8	8
2,5	2,2	6

CX 6/36

# CX 12 poles (40A - 690V) + 2 poles (10A - 250V) + ⊕

enclosures: size "77.27"	page:
C-TYPE IP65/IP66	402 - 411
C7 IP67, two levers	439 - 440
V-TYPE IP65/IP66, single lever	454 - 458
BIG hoods	470 - 471
T-TYPE IP65 insulating	484 - 485
T-TYPE / W IP66 insulating	491
HYGIENIC T-TYPE / H IP66/IP69	503
HYGIENIC T-TYPE / C IP66/IP69, -50 °C	508
W-TYPE for aggressive environments	523
E-Xtreme® corrosion proof	534 - 535, 544, 554 - 555
EMC	580
Central lever	609 - 611
LS-TYPE	622 - 623
IP68	640 - 643
panel supports: COB	page: 652 - 653

inserts, crimp connections

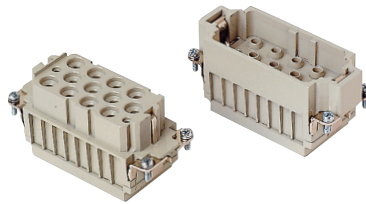

40A and 10A crimp contacts  
silver and gold plated



description	part No.	part No.
without contacts (to be ordered separately)		
female inserts for female contacts	CXF 12/2	
male inserts for male contacts	CXM 12/2	
40A female crimp contacts		
1,5 mm <sup>2</sup> AWG 16		CXFA 1.5
2,5 mm <sup>2</sup> AWG 14		CXFA 2.5
4 mm <sup>2</sup> AWG 12		CXFA 4.0
6 mm <sup>2</sup> AWG 10		CXFA 6.0
40A male crimp contacts		
1,5 mm <sup>2</sup> AWG 16		CXMA 1.5
2,5 mm <sup>2</sup> AWG 14		CXMA 2.5
4 mm <sup>2</sup> AWG 12		CXMA 4.0
6 mm <sup>2</sup> AWG 10		CXMA 6.0
10A female contacts		
0,14-0,37 mm <sup>2</sup> AWG 26-22 identification No. 1		C DFA 0.3
0,5 mm <sup>2</sup> AWG 20 identification No. 2		C DFA 0.5
0,75 mm <sup>2</sup> AWG 18 identification No. ②		C DFA 0.7
1 mm <sup>2</sup> AWG 18 identification No. 3		C DFA 1.0
1,5 mm <sup>2</sup> AWG 16 identification No. 4		C DFA 1.5
2,5 mm <sup>2</sup> AWG 14 identification No. 5		C DFA 2.5
10A male contacts		
0,14-0,37 mm <sup>2</sup> AWG 26-22 identification No. 1		C DMA 0.3
0,5 mm <sup>2</sup> AWG 20 identification No. 2		C DMA 0.5
0,75 mm <sup>2</sup> AWG 18 identification No. ②		C DMA 0.7
1 mm <sup>2</sup> AWG 18 identification No. 3		C DMA 1.0
1,5 mm <sup>2</sup> AWG 16 identification No. 4		C DMA 1.5
2,5 mm <sup>2</sup> AWG 14 identification No. 5		C DMA 2.5

silver plated

+ for basic or high thickness gold plating, please refer to page 674

gold plated+

- characteristics according to EN 61984:
- 40A 690V 8kV 3**
- 10A 160V 2,5kV 3**
- 10A 250V 4kV 2**
- certified
- rated voltage according to UL/CSA: 600V
- insulation resistance: ≥ 10 GΩ
- ambient temperature limit: -40 °C ... +125 °C
- made of self-extinguishing thermoplastic resin UL 94V-0
- mechanical life: ≥ 500 cycles
- contact resistance: ≤ 0,3 mΩ (12 poles), ≤ 1 mΩ (2 poles)
- for max. current load see the connector inserts derating diagram below; for more information see page 28

CX 12/2 power poles connector inserts  
Maximum current load derating diagram

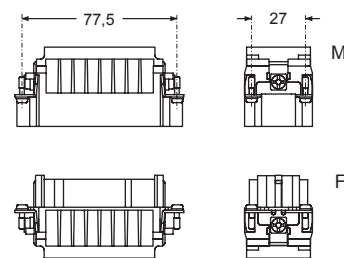
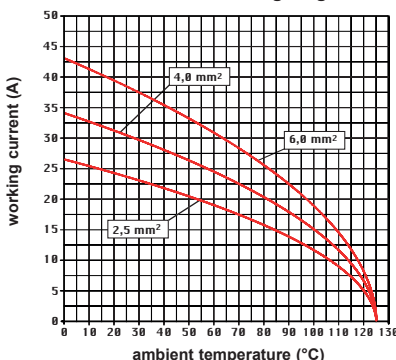

contacts side (front view)

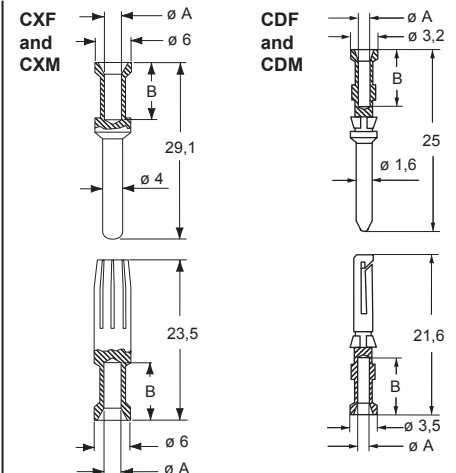
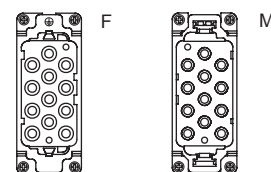

CXF and CXM contacts

conductor section	conductor slot	conductors stripping length
mm <sup>2</sup>	ø A (mm)	B (mm)
1,5	1,8	9
2,5	2,2	9
4	2,85	9,6
6	3,5	9,6

CDF and CDM contacts

0,14-0,37	0,9	8
0,5	1,1	8
0,75	1,3	8
1,0	1,45	8
1,5	1,8	8
2,5	2,2	6

- it is recommended to crimp the contacts with crimping tools homologated by ILME (please see the crimping tool section 40A contacts, CXF, CXM series and 10A contacts CDF, CDM series on pages 705 - 741

# CX 4 poles (80A - 830V) + ⊕

enclosures: size "77.27"	page:
C-TYPE IP65/IP66	402 - 411
C7 IP67, two levers	439 - 440
V-TYPE IP65/IP66, single lever	454 - 458
BIG hoods	470 - 471
T-TYPE IP65 insulating	484 - 485
T-TYPE / W IP66 insulating	491
HYGIENIC T-TYPE / H IP66/IP69	503
HYGIENIC T-TYPE / C IP66/IP69, -50 °C	508
W-TYPE for aggressive environments	523
E-Xtreme® corrosion proof	534 - 535, 544, 554 - 555
EMC	580
Central lever	609 - 611
LS-TYPE	622 - 623
IP68	640 - 643
panel supports: COB	page: 652 - 653

## inserts, screw terminal connection

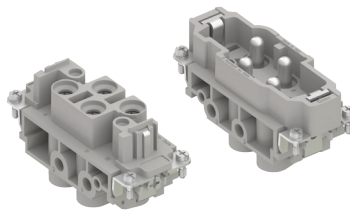

**✓ RATING 830V**  
**Q SILVER PLATED CONTACTS**

description	part No.
female inserts with female contacts	CXF 4/0
male inserts with male contacts	CXM 4/0

- characteristics according to EN 61984:
- 80A 830V 8kV 3**
- certified
- rated voltage according to UL/CSA: 600V
- insulation resistance: ≥ 10 GΩ
- ambient temperature limit: -40 °C ... +125 °C
- made of self-extinguishing thermoplastic resin UL 94V-0
- mechanical life: ≥ 500 cycles
- contact resistance: ≤ 0,3 mΩ
- for max. current load see the connector inserts derating diagram below; for more information see page 28

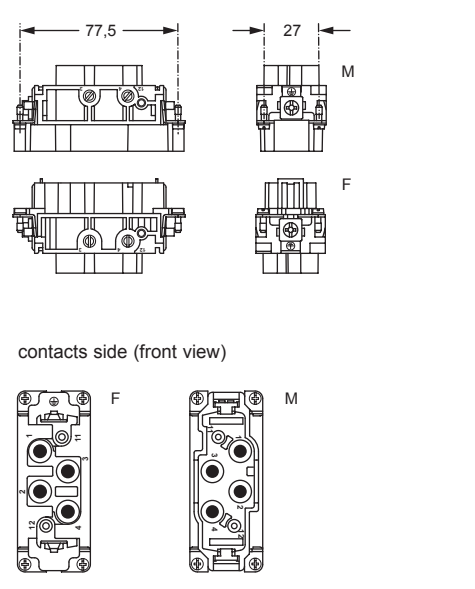

- 80A contacts**
- without plate for section conductors: 4 - 16 mm<sup>2</sup> - AWG 12 - 6
  - conductors stripping length: 14 mm
  - terminal screw torque: 2,5 Nm (22.1 lb.in), for more information see page 20 and 21

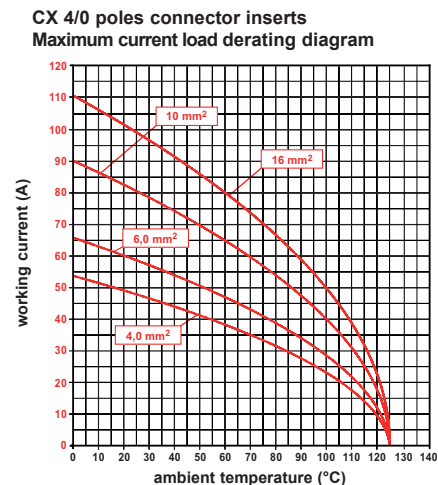

CX 4/0



# CX 4 poles (80A - 830V) + 2 poles (16A - 400V) + ⊕

enclosures: size "77.27"	page:
C-TYPE IP65/IP66	402 - 411
C7 IP67, two levers	439 - 440
V-TYPE IP65/IP66, single lever	454 - 458
BIG hoods	470 - 471
T-TYPE IP65 insulating	484 - 485
T-TYPE / W IP66 insulating	491
HYGIENIC T-TYPE / H IP66/IP69	503
HYGIENIC T-TYPE / C IP66/IP69, -50 °C	508
W-TYPE for aggressive environments	523
E-Xtreme® corrosion proof	534 - 535, 544, 554 - 555
EMC	580
Central lever	609 - 611
LS-TYPE	622 - 623
IP68	640 - 643
panel supports: COB	page: 652 - 653

## inserts, screw terminal connection

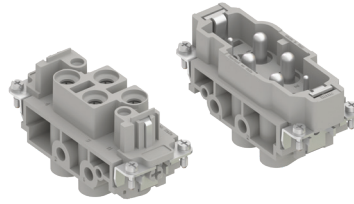

**Q RATING 830V**  
**Q SILVER PLATED CONTACTS**

description	part No.
-------------	----------

female inserts with female contacts	CXF 4/2
male inserts with male contacts	CXM 4/2

- characteristics according to EN 61984:  
**80A 830V 8kV 3**  
**16A 400V 6kV 3**  
**16A 400/690V 6kV 2**
- certified
- rated voltage according to UL/CSA: 600V
- insulation resistance: ≥ 10 GΩ
- ambient temperature limit: -40 °C ... +125 °C
- made of self-extinguishing thermoplastic resin UL 94V-0
- mechanical life: ≥ 500 cycles
- contact resistance:  
≤ 0,3 mΩ (4 poles)  
≤ 1 mΩ (2 poles)
- for max. current load see the connector inserts derating diagrams below; for more information see page 28

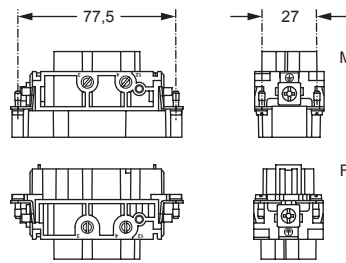

contacts side (front view)

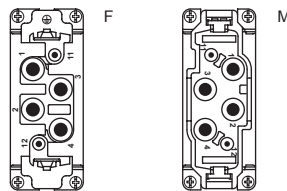

### 80A contacts

- without plate for section conductors:  
4 - 16 mm<sup>2</sup> - AWG 12 - 6
- conductors stripping length: 14 mm
- terminal screw torque: 2,5 Nm (22.1 lb.in),  
for more information see page 20 and 21

### 16A contacts

- without plate for section conductors:  
0,25 - 2,5 mm<sup>2</sup> - AWG 24 - 14
- conductors stripping length: 7 mm
- terminal screw torque: 0,5 Nm (4.4 lb.in),  
for more information see page 20 and 21

### CX 4/2 poles connector inserts Maximum current load derating diagram

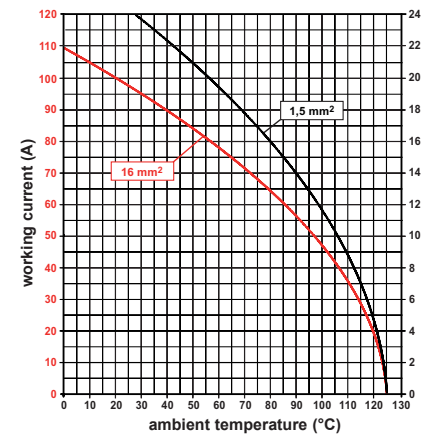
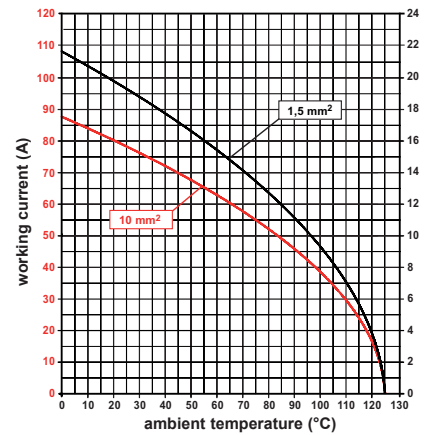
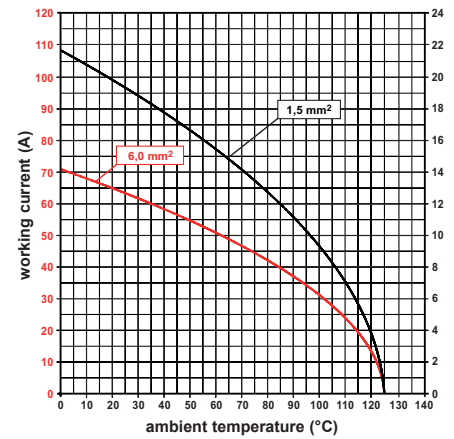

enclosures: size "77.27"	page:
C-TYPE IP65/IP66	402 - 411
C7 IP67, two levers	439 - 440
V-TYPE IP65/IP66, single lever	454 - 458
BIG hoods	470 - 471
T-TYPE IP65 insulating	484 - 485
T-TYPE / W IP66 insulating	491
HYGIENIC T-TYPE / H IP66/IP69	503
HYGIENIC T-TYPE / C IP66/IP69, -50 °C	508
W-TYPE for aggressive environments	523
E-Xtreme® corrosion proof	534 - 535, 544, 554 - 555
EMC	580
For 180 °C	588
Central lever	609 - 611
LS-TYPE	622 - 623
IP68	640 - 643
panel supports: COB	page: 652 - 653

inserts,  
screw terminal connection

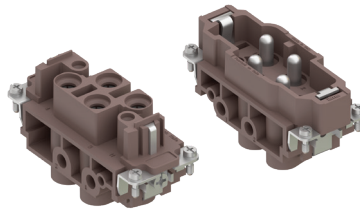

**✍ RATING 830V**  
**🌡 180 °C**  
**Q SILVER PLATED CONTACTS**

description

part No.

use in temperatures up to 180 °C  
female inserts with female contacts, brown  
male inserts with male contacts, brown

**CXF 4/0 RY**  
**CXM 4/0 RY**

- characteristics according to EN 61984:  
**80A 830V 8kV 3**
- certified
- rated voltage according to UL/CSA: 600V
- insulation resistance: ≥ 10 GΩ
- ambient temperature limit: -40 °C ... +180 °C
- made of self-extinguishing thermoplastic resin UL 94V-0
- mechanical life: ≥ 500 cycles
- contact resistance:  
≤ 0,3 mΩ
- for max. current load see the connector inserts derating diagram below; for more information see page 28

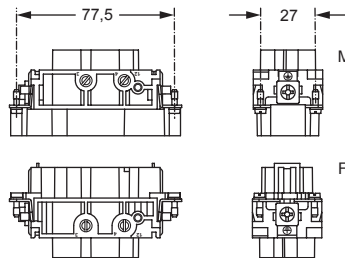

contacts side (front view)

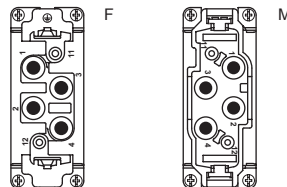

**80A contacts**

- without plate for section conductors:  
4-16 mm<sup>2</sup> - AWG 12-6
- conductors stripping length: 14 mm
- terminal screw torque: 2,5 Nm (22.1 lb.in),  
for more information see page 20 and 21

**CX...RY 4/0 poles connector inserts**  
**Maximum current load derating diagram**

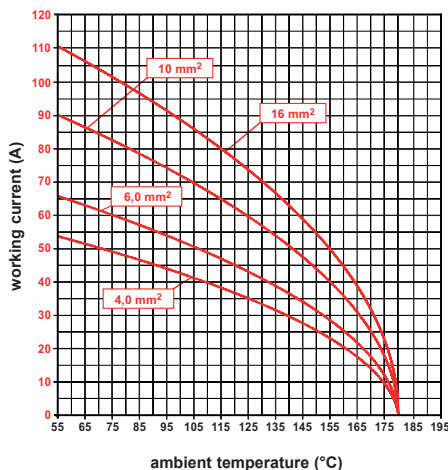

CX...RY 4/0

enclosures: size "77.27"	page:
C-TYPE IP65/IP66	402 - 411
C7 IP67, two levers	439 - 440
V-TYPE IP65/IP66, single lever	454 - 458
BIG hoods	470 - 471
T-TYPE IP65 insulating	484 - 485
T-TYPE / W IP66 insulating	491
HYGIENIC T-TYPE / H IP66/IP69	503
HYGIENIC T-TYPE / C IP66/IP69, -50 °C	508
W-TYPE for aggressive environments	523
E-Xtreme® corrosion proof	534 - 535, 544, 554 - 555
EMC	580
For 180 °C	588
Central lever	609 - 611
LS-TYPE	622 - 623
IP68	640 - 643
panel supports:	page:
COB	652 - 653

**inserts,  
screw terminal connection**

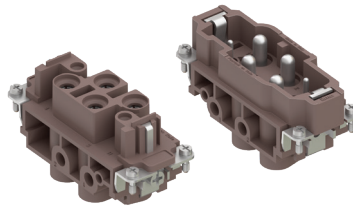

**✍ RATING 830V**  
**🌡 180 °C**  
**🔍 SILVER PLATED CONTACTS**

description	part No.
-------------	----------

use in temperatures up to 180 °C  
 female inserts with female contacts, brown  
 male inserts with male contacts, brown

**CXF 4/2 RY**  
**CXM 4/2 RY**

- characteristics according to EN 61984:  
**80A 830V 8kV 3**  
**16A 400V 6kV 3**  
**16A 400/690V 6kV 2**
- certified
- rated voltage according to UL/CSA: 600V
- insulation resistance: ≥ 10 GΩ
- ambient temperature limit: -40 °C ... +180 °C
- made of self-extinguishing thermoplastic resin  
 UL 94V-0
- mechanical life: ≥ 500 cycles
- contact resistance:  
 ≤ 0,3 mΩ (4 poles)  
 ≤ 1 mΩ (2 poles)
- for max. current load see the connector inserts derating diagram below; for more information see page 28

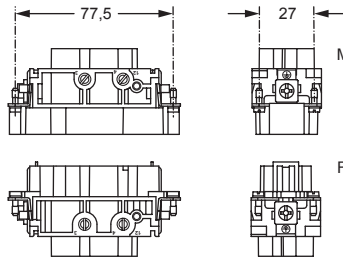

contacts side (front view)

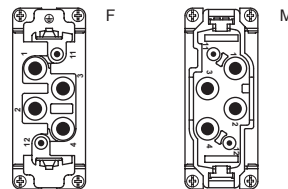

**80A contacts**

- without plate for section conductors:  
 4 - 16 mm<sup>2</sup> - AWG 12 - 6
- conductors stripping length: 14 mm
- terminal screw torque: 2,5 Nm (22.1 lb.in),  
 for more information see page 20 and 21

**16A contacts**

- without plate for section conductors:  
 0,25 - 2,5 mm<sup>2</sup> - AWG 24 - 14
- conductors stripping length: 7 mm
- terminal screw torque: 0,5 Nm (4.4 lb.in),  
 for more information see page 20 and 21

**CX...RY 4/2 poles connector inserts  
 Maximum current load derating diagram**

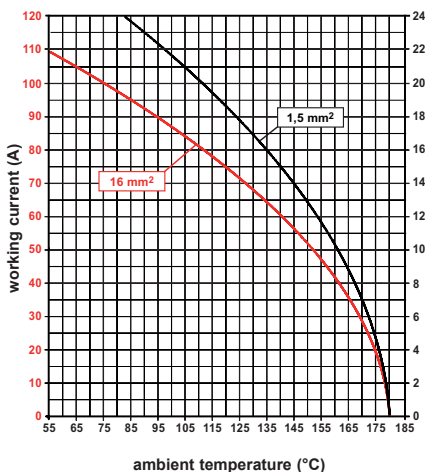

enclosures: size "104.27"	page:
C-TYPE IP65/IP66	412 - 423
C7 IP67, two levers	441 - 442
V-TYPE IP65/IP66, single lever	459 - 463
BIG hoods	472 - 473
T-TYPE IP65 insulating	486 - 487
T-TYPE / W IP66 insulating	492
HYGIENIC T-TYPE / H IP66/IP69	504
HYGIENIC T-TYPE / C IP66/IP69, -50 °C	509
W-TYPE for aggressive environments	524
E-Xtreme® corrosion proof	536 - 537, 545, 556 - 557
EMC	581
For 180 °C	589
Central lever	612 - 614
LS-TYPE	624 - 625
IP68	644 - 647
panel supports: COB	page: 652 - 653

inserts,  
screw terminal connection

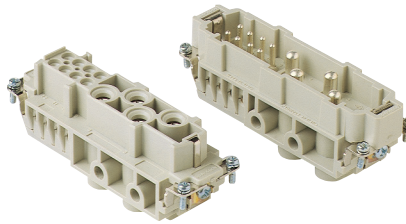

☺ 180 °C  
Q SILVER PLATED CONTACTS

inserts,  
screw terminal connection

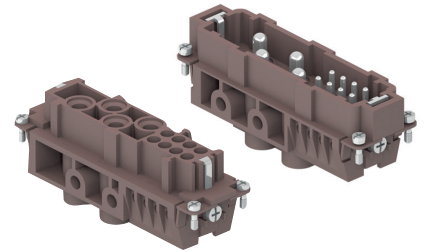

☺ 180 °C  
Q SILVER PLATED CONTACTS

description

part No.

part No

female inserts with female contacts  
male inserts with male contacts  
use in temperatures up to 180 °C  
female inserts with female contacts  
male inserts with male contacts

CXF 4/8  
CXM 4/8

CXF 4/8 RY  
CXM 4/8 RM

- characteristics according to EN 61984:  
80A 400V 6kV 3  
80A 400/690V 6kV 2  
16A 230/400V 4kV 3  
16A 400V 4kV 2
- certified
- rated voltage according to UL/CSA: 600V
- insulation resistance: ≥ 10 GΩ
- ambient temperature limit: -40 °C ... +125 °C
- made of self-extinguishing thermoplastic resin UL 94V-0
- mechanical life: ≥ 500 cycles
- contact resistance:  
≤ 0,3 mΩ (4 poles)  
≤ 1 mΩ (8 poles)
- for max. current load see the connector inserts derating diagram below; for more information see page 28

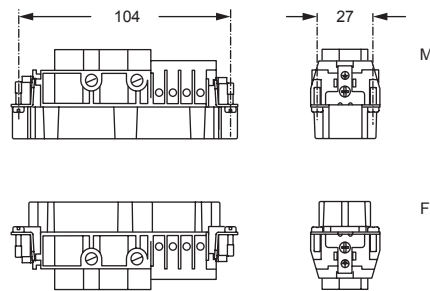

contacts side (front view)

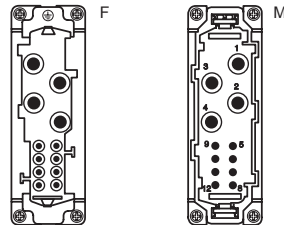

- 80A contacts**
- without plate for section conductors:  
4 - 16 mm<sup>2</sup> - AWG 12 - 6
  - conductors stripping length: 14 mm
  - terminal screw torque: 2,5 Nm (22.1 lb.in), for more information see page 20 and 21
- 16A contacts**
- with plate for section conductors:  
0,75 - 2,5 mm<sup>2</sup> - AWG 18 - 14
  - conductors stripping length: 7 mm
  - terminal screw torque: 0,5 Nm (4.4 lb.in), for more information see page 20 and 21

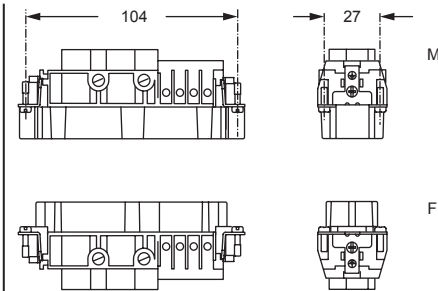

contacts side (front view)

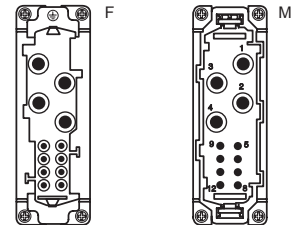

- 80A contacts**
- without plate for section conductors:  
4 - 16 mm<sup>2</sup> - AWG 12 - 6
  - conductors stripping length: 14 mm
  - terminal screw torque: 2,5 Nm (22.1 lb.in), for more information see page 20 and 21
- 16A contacts**
- with plate for section conductors:  
0,75 - 2,5 mm<sup>2</sup> - AWG 18 - 14
  - conductors stripping length: 7 mm
  - terminal screw torque: 0,5 Nm (4.4 lb.in), for more information see page 20 and 21

**CX 4/8 poles connector inserts**  
Maximum current load derating diagram

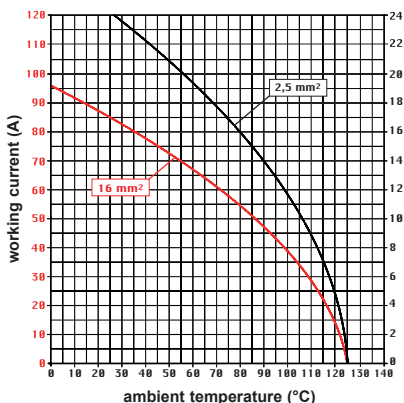
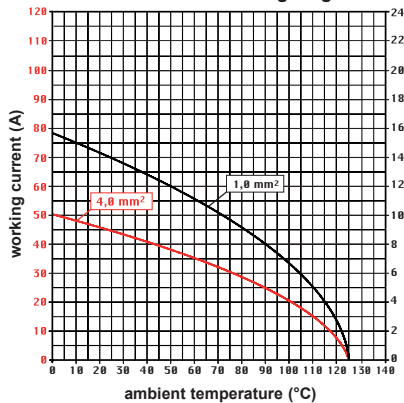

**CX RY 4/8 poles connector inserts**  
Maximum current load derating diagram

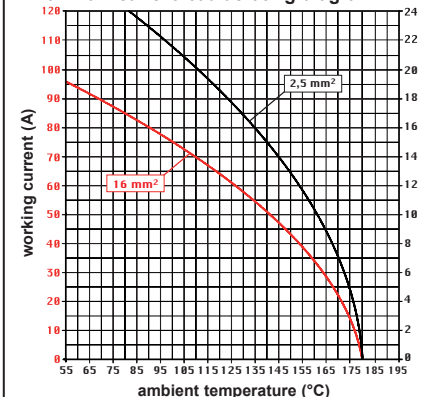

CX - CX...RY 4/8

## CX 6/6 inserts 100A/16A version

The CX series of combined “power /auxiliaries” connector inserts has been enhanced with a **new insert, CX 6/6 suitable for currents up to 100A** in the power side and 16A on the auxiliaries side, for crimp contacts series CG (100A max) and series CC (16A max) several benefits over conventional screw or axial screw contacts:

- more **resistant to mechanical stresses** such as vibrations, shock and cable loads;
- more **corrosion resistant** (gas tight);
- **quicker to connect** and ensuring more **consistent results** (regardless of the operators “force”);
- the connector is **electrically more efficient** (reduced voltage drop).

This innovative insert design, by following the same concepts of the MIXO 100A CX..G model, **patented by ILME**, ensures a quicker fitting and removal of crimped contacts.

The **provided locking keys** firmly fasten the contact holder. The power contacts may be removed **without any special tool**, using a simple screwdriver (e.g.: 0,5 x 3 mm, 0,5 x 3,5 mm, 0,6 x 4 mm and 0,8 x 4 mm flat blade).

The removal of auxiliary contacts series CC requires the CQES extraction tool. See figure below.

The crimping operation may be carried out quickly and efficiently with the **hand operated hydraulic pliers**, which is pre-fitted with the suitable locator. Suitable crimp dies are available on request.

Inserts series		CX 6/6	
No. of poles	main contact	6 + ⊕ (100A) **	
	auxiliary contacts	6 (16A)	
rated current <sup>1)</sup>		100A	16A
EN 61984 pollution degree 3	rated voltage	690V	400V
	rated impulse withstand voltage	8kV	6kV
	pollution degree	3	3
contact resistance		≤ 0,3 mΩ (100A) ≤ 1 mΩ (16A)	
insulation resistance		≥ 10 GΩ	
ambient temperature limit (°C)	min	-40 °C	
	max	+125 °C	
degree of protection	with enclosures (according to version)	IP65, IP66, IP67, IP68, IP69	
	without enclosures	IP20	
conductor connections *		crimp	
conductor cross-section (CG contact series)	mm <sup>2</sup>	16, 25, 35	
	AWG	6 - 5, 4 - 3, 2	
conductor cross-section (CC contact series)	mm <sup>2</sup>	0,14 ..... 4,0	
	AWG	26 ÷ 12	
CG/CC stripping length	mm	15 / 7,5	
mechanical endurance (mating cycles)		≥ 500	

<sup>1)</sup> Please check the insert load curves to establish the actual maximum operating current according to the ambient temperature.

\* max external conductor Ø = 11,5 mm

\*\* the power PE contact is not included and must be the same size as the power contacts used (for a total n° at contacts = 7)

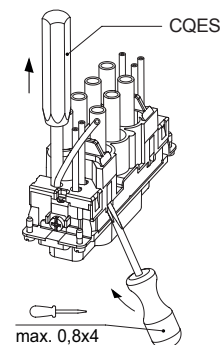
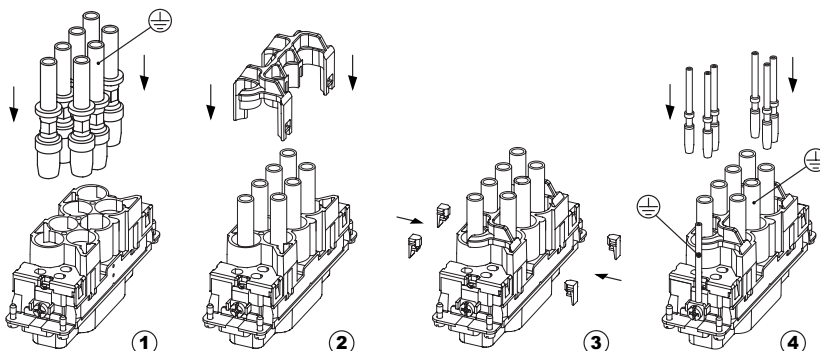



# CX 6 poles + ⊕ (100A - 690V) + 6 poles (16A - 400V) + ⊖

enclosures: size "104.27"	page:
C-TYPE IP65/IP66	412 - 423
C7 IP67, two levers	441 - 442
V-TYPE IP65/IP66, single lever	459 - 463
BIG hoods	472 - 473
T-TYPE IP65 insulating	486 - 487
T-TYPE / W IP66 insulating	492
HYGIENIC T-TYPE / H IP66/IP69	504
HYGIENIC T-TYPE / C IP66/IP69, -50 °C	509
W-TYPE for aggressive environments	524
E-Xtreme® corrosion proof	536 - 537, 545, 556 - 557
EMC	581
Central lever	612 - 614
LS-TYPE	624 - 625
IP68	644 - 647

panel supports: COB	page: 652 - 653
------------------------	--------------------

enclosures:  
bulkhead mounting housings, high construction housings  
or high construction hoods

## inserts, crimp connections

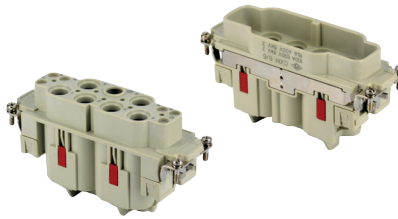

## 100A and 16A crimp contacts silver and gold plated



description	part No.	part No.
-------------	----------	----------

without contacts (to be ordered separately)

female inserts for female contacts

CXF 6/6

male inserts for male contacts

CXM 6/6

100A female crimp contacts

8 - 10 mm <sup>2</sup>	AWG 8 - 7
16 mm <sup>2</sup>	AWG 6 - 5
25 mm <sup>2</sup>	AWG 4 - 3
35 mm <sup>2</sup>	AWG 2

CGFA 10  
CGFA 16  
CGFA 25  
CGFA 35

silver plated

100A male crimp contacts

8 - 10 mm <sup>2</sup>	AWG 8 - 7
16 mm <sup>2</sup>	AWG 6 - 5
25 mm <sup>2</sup>	AWG 4 - 3
35 mm <sup>2</sup>	AWG 2

CGMA 10  
CGMA 16  
CGMA 25  
CGMA 35

\* for basic or high thickness gold plating, please refer to page 675

16A female contacts

0,14-0,37 mm <sup>2</sup>	AWG 26-22	one groove
0,5 mm <sup>2</sup>	AWG 20	with no grooves
0,75 mm <sup>2</sup>	AWG 18	one groove (back side)
1 mm <sup>2</sup>	AWG 18	one groove
1,5 mm <sup>2</sup>	AWG 16	two grooves
2,5 mm <sup>2</sup>	AWG 14	three grooves
3 mm <sup>2</sup>	AWG 12	one wide groove
4 mm <sup>2</sup>	AWG 12	with no grooves

CCFA 0.3  
CCFA 0.5  
CCFA 0.7  
CCFA 1.0  
CCFA 1.5  
CCFA 2.5  
CCFA 3.0  
CCFA 4.0

CCFD 0.3  
CCFD 0.5  
CCFD 0.7  
CCFD 1.0  
CCFD 1.5  
CCFD 2.5  
CCFD 3.0  
CCFD 4.0

gold plated

16A male contacts

0,14-0,37 mm <sup>2</sup>	AWG 26-22	one groove
0,5 mm <sup>2</sup>	AWG 20	with no grooves
0,75 mm <sup>2</sup>	AWG 18	one groove (back side)
1 mm <sup>2</sup>	AWG 18	one groove
1,5 mm <sup>2</sup>	AWG 16t	no grooves
2,5 mm <sup>2</sup>	AWG 14	three grooves
3 mm <sup>2</sup>	AWG 12	one wide groove
4 mm <sup>2</sup>	AWG 12	with no grooves

CCMA 0.3  
CCMA 0.5  
CCMA 0.7  
CCMA 1.0  
CCMA 1.5  
CCMA 2.5  
CCMA 3.0  
CCMA 4.0

CCMD 0.3  
CCMD 0.5  
CCMD 0.7  
CCMD 1.0  
CCMD 1.5  
CCMD 2.5  
CCMD 3.0  
CCMD 4.0

- characteristics according to EN 61984:

**100A 690V 8kV 3**

**16A 400V 6kV 3**

- cULus (UL for USA and Canada),

- certified

- insulation resistance: ≥ 10 GΩ

- ambient temperature limit: -40 °C ... +125 °C

- made of self-extinguishing thermoplastic resin UL 94V-0

- mechanical life: ≥ 500 cycles

- contact resistance: ≤ 0,3 mΩ (100A), ≤ 1 mΩ (16A)

- for max. current load see the connector inserts derating diagram below; for more information see page 28

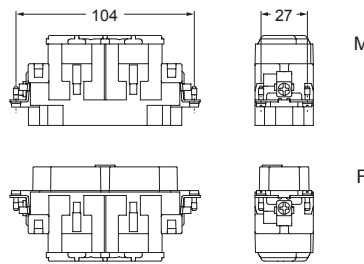

contacts side (front view)

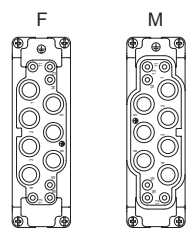

CGF and CGM

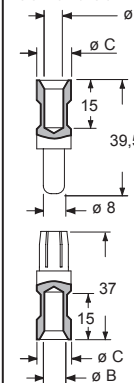

CCF and CCM

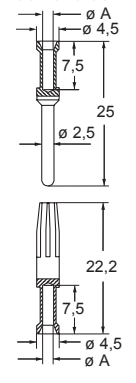

CGF and CGM contacts

conductor section (mm <sup>2</sup> )	conductor slot ø A (mm)	ø B (mm)	ø C (mm)	conductor stripping length (mm)
8-10	4,3	4,3	13	15
16	5,5	5,5	13	15
25	7,0	7,0	13	15
35	7,9	8,2	12,5	15

CCF and CCM contacts

conductor section (mm <sup>2</sup> )	conductor slot ø A (mm)	conductors stripping length (mm)
0,14-0,37	0,9	7,5
0,5	1,1	7,5
0,75	1,3	7,5
1,0	1,45	7,5
1,5	1,8	7,5
2,5	2,2	7,5
3	2,55	7,5
4	2,85	7,5

CGX 6/6 power poles connector inserts  
Maximum current load derating diagram

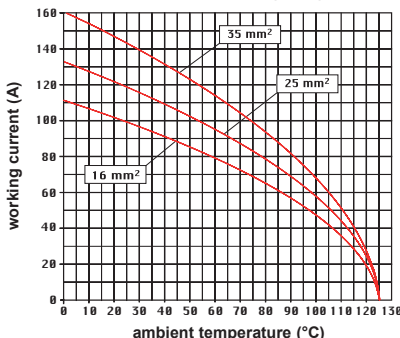

- it is recommended to crimp the contacts with crimping tools homologated by ILME (please see the crimping tool section 100A contacts CGF, CGM series and 16A contacts CCF, CCM series) on pages 705 - 741

CX 6/6



## HNM series

### TECHNICAL FEATURES

Specifically designed for applications requiring a high number of mating cycles, the **HNM series** guarantees **up to 10.000 matings**.

Ideal for test benches, the special **HNM inserts** guarantee 10.000 matings when used together with the **dedicated enclosure series**, thanks to the special antifriction treatment applied both on the contacts of the inserts and on the V-TYPE locking lever and the riveted pegs.

5.000 matings are achieved when working with standard enclosures.

The series features **special versions of the 10 and 16A gold plated crimp contacts** to be used both with **special crimp inserts** (up to 108 poles) and with standard MIXO inserts mounted in **special frames** equipped with **gold PE contacts**.

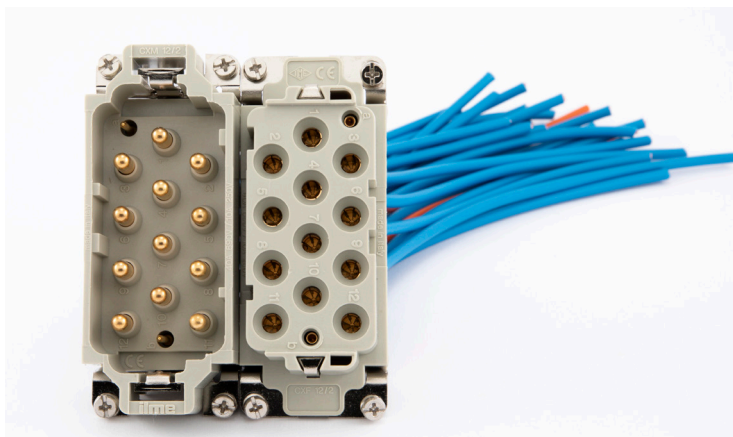

#### SUM-UP

- ☑ **Special treatment + special lubricant**
- ☑ **HNM marking on each insert**

# RD 40 poles + ⊕ 10A - 250V HNM (High Number of Matings)

enclosures:  
size "77.27"

page:

HNM  
C-TYPE IP65/IP66, single lever  
V-TYPE IP65/IP66, single lever

596 - 597  
402 - 411  
454 - 458

inserts, crimp connections

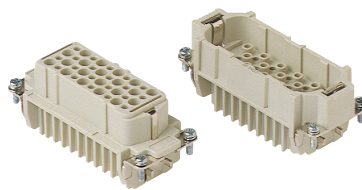

10A crimp contacts  
gold plated



Q 10.000 MATINGS WITH HNM ENCLOSURES

Q 5.000 MATINGS WITH STANDARD ENCLOSURES, SINGLE LEVER

description

part No.

part No.

without contacts (to be ordered separately)  
female inserts for female contacts  
male inserts for male contacts

RDF 40  
RDM 40

10A female contacts

0,14-0,37 mm <sup>2</sup>	AWG 26-22	identification No. 1
0,5 mm <sup>2</sup>	AWG 20	identification No. 2
0,75 mm <sup>2</sup>	AWG 18	identification No. ②
1 mm <sup>2</sup>	AWG 18	identification No. 3
1,5 mm <sup>2</sup>	AWG 16	identification No. 4
2,5 mm <sup>2</sup>	AWG 14	identification No. 5

RDF2D 0.3  
RDF2D 0.5  
RDF2D 0.7  
RDF2D 1.0  
RDF2D 1.5  
RDF2D 2.5

gold plated

10A male contacts

0,14-0,37 mm <sup>2</sup>	AWG 26-22	identification No. 1
0,5 mm <sup>2</sup>	AWG 20	identification No. 2
0,75 mm <sup>2</sup>	AWG 18	identification No. ②
1 mm <sup>2</sup>	AWG 18	identification No. 3
1,5 mm <sup>2</sup>	AWG 16	identification No. 4
2,5 mm <sup>2</sup>	AWG 14	identification No. 5

RDM2D 0.3  
RDM2D 0.5  
RDM2D 0.7  
RDM2D 1.0  
RDM2D 1.5  
RDM2D 2.5

- characteristics according to EN 61984:

**10A 250V 4kV 3**  
**10A 230/400V 4kV 2**

- DNV-GL VERITAS EAC certified
- insulation resistance:  $\geq 10 \text{ G}\Omega$
- ambient temperature limit:  $-40 \text{ }^\circ\text{C} \dots +125 \text{ }^\circ\text{C}$
- made of self-extinguishing thermoplastic resin UL 94V-0
- mechanical life:  $\geq 10.000$  cycles
- contact resistance:  $\leq 3 \text{ m}\Omega$
- for applications requiring higher voltages, please see the special voltage application section on page 65
- it is recommended to crimp the contacts with crimping tools homologated by ILME (please see the crimping tool section 10A contacts, RDF2D and RDM2D series) on pages 705 - 741
- for max. current load see the connector inserts derating diagram below; for more information see page 28

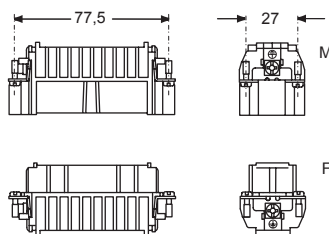

contacts side (front view)

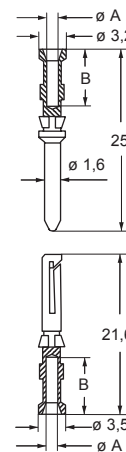
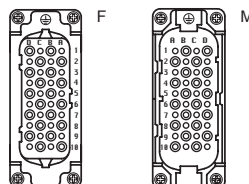

RDF2D and RDM2D contacts

conductor section mm <sup>2</sup>	conductor slot ø A (mm)	conductors stripping length B (mm)
0,14-0,37	0,9	8
0,5	1,1	8
0,75	1,3	8
1,0	1,45	8
1,5	1,8	8
2,5	2,2	6

RD 40 poles connector inserts  
Maximum current load derating diagram

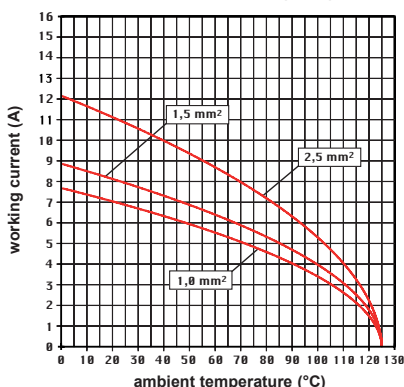

CR CP coding pin with loss of one contact (page 684)



# RD 64 poles + ⊕ 10A - 250V HNM (High Number of Matings)

enclosures:  
size "104.27"

page:

HNM  
C-TYPE IP65/IP66, single lever  
V-TYPE IP65/IP66, single lever

598 - 599  
412 - 423  
459 - 463

inserts, crimp connections

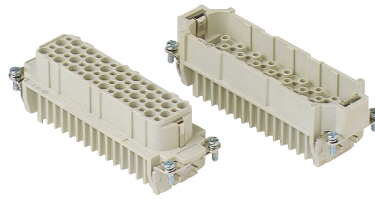

10A crimp contacts  
gold plated



Q 10.000 MATINGS WITH HNM ENCLOSURES

Q 5.000 MATINGS WITH STANDARD ENCLOSURES, SINGLE LEVER

description	part No.	part No.
-------------	----------	----------

without contacts (to be ordered separately)  
female inserts for female contacts  
male inserts for male contacts

RDF 64  
RDM 64

10A female contacts

0,14-0,37 mm <sup>2</sup>	AWG 26-22	identification No. 1
0,5 mm <sup>2</sup>	AWG 20	identification No. 2
0,75 mm <sup>2</sup>	AWG 18	identification No. ②
1 mm <sup>2</sup>	AWG 18	identification No. 3
1,5 mm <sup>2</sup>	AWG 16	identification No. 4
2,5 mm <sup>2</sup>	AWG 14	identification No. 5

RDF2D 0.3  
RDF2D 0.5  
RDF2D 0.7  
RDF2D 1.0  
RDF2D 1.5  
RDF2D 2.5

gold plated+

10A male contacts

0,14-0,37 mm <sup>2</sup>	AWG 26-22	identification No. 1
0,5 mm <sup>2</sup>	AWG 20	identification No. 2
0,75 mm <sup>2</sup>	AWG 18	identification No. ②
1 mm <sup>2</sup>	AWG 18	identification No. 3
1,5 mm <sup>2</sup>	AWG 16	identification No. 4
2,5 mm <sup>2</sup>	AWG 14	identification No. 5

RDM2D 0.3  
RDM2D 0.5  
RDM2D 0.7  
RDM2D 1.0  
RDM2D 1.5  
RDM2D 2.5

- characteristics according to EN 61984:

**10A 250V 4kV 3**  
**10A 230/400V 4kV 2**

- DNV-GL BUREAU VERITAS EAC certified
- insulation resistance:  $\geq 10$  G $\Omega$
- ambient temperature limit: -40 °C ... +125 °C
- made of self-extinguishing thermoplastic resin UL 94V-0
- mechanical life:  $\geq 10.000$  cycles
- contact resistance:  $\leq 3$  m $\Omega$
- for applications requiring higher voltages, please see the special voltage application section on page 65
- it is recommended to crimp the contacts with crimping tools homologated by ILME (please see the crimping tool section 10A contacts, RDF2D and RDM2D series) on pages 705 - 741
- for max. current load see the connector inserts derating diagram below; for more information see page 28

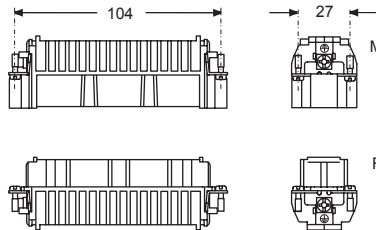

contacts side (front view)

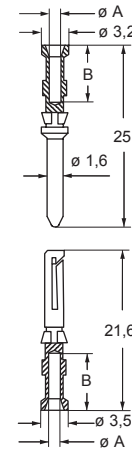
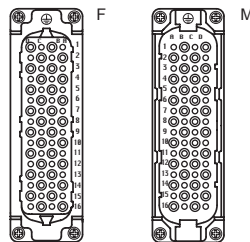

RDF2D and RDM2D contacts

conductor section mm <sup>2</sup>	conductor slot $\phi A$ (mm)	conductors stripping length B (mm)
0,14-0,37	0,9	8
0,5	1,1	8
0,75	1,3	8
1,0	1,45	8
1,5	1,8	8
2,5	2,2	6

RD 64 poles connector inserts  
Maximum current load derating diagram

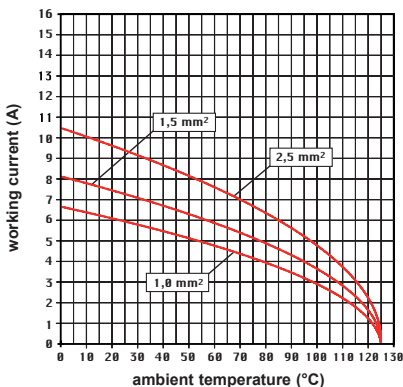

CR CP coding pin with loss of one contact (page 684)



# RDD 24 poles + ⊕ 10A - 250V HNM (High Number of Matings)

enclosures:  
size "44.27"

page:

HNM

592 - 593

inserts, crimp connections

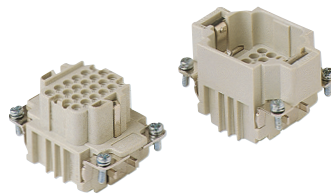

10A crimp contacts  
gold plated



**Q 10.000 MATINGS WITH HNM ENCLOSURES**

description

part No.

part No.

without contacts (to be ordered separately)  
female inserts for female contacts  
male inserts for male contacts

**RDDF 24**  
**RDDM 24**

10A female contacts

0,14-0,37 mm <sup>2</sup>	AWG 26-22	identification No. 1
0,5 mm <sup>2</sup>	AWG 20	identification No. 2
0,75 mm <sup>2</sup>	AWG 18	identification No. ②
1 mm <sup>2</sup>	AWG 18	identification No. 3
1,5 mm <sup>2</sup>	AWG 16	identification No. 4
2,5 mm <sup>2</sup>	AWG 14	identification No. 5

**RDF2D 0.3**  
**RDF2D 0.5**  
**RDF2D 0.7**  
**RDF2D 1.0**  
**RDF2D 1.5**  
**RDF2D 2.5**

gold plated

10A male contacts

0,14-0,37 mm <sup>2</sup>	AWG 26-22	identification No. 1
0,5 mm <sup>2</sup>	AWG 20	identification No. 2
0,75 mm <sup>2</sup>	AWG 18	identification No. ②
1 mm <sup>2</sup>	AWG 18	identification No. 3
1,5 mm <sup>2</sup>	AWG 16	identification No. 4
2,5 mm <sup>2</sup>	AWG 14	identification No. 5

**RDM2D 0.3**  
**RDM2D 0.5**  
**RDM2D 0.7**  
**RDM2D 1.0**  
**RDM2D 1.5**  
**RDM2D 2.5**

- characteristics according to EN 61984:

**10A 250V 4kV 2**

- certified
- insulation resistance:  $\geq 10 \text{ G}\Omega$
- ambient temperature limit:  $-40 \text{ }^\circ\text{C} \dots +125 \text{ }^\circ\text{C}$
- made of self-extinguishing thermoplastic resin UL 94V-0
- mechanical life:  $\geq 10.000$  cycles
- contact resistance:  $\leq 3 \text{ m}\Omega$
- for applications requiring higher voltages, please see the special voltage application section on page 75
- **it is recommended to crimp the contacts with crimping tools homologated by ILME** (please see the crimping tool section 10A contacts, RDF2D and RDM2D series) on pages 705 - 741
- PCBs interface, see article CIF 2.4
- for max. current load see the connector inserts derating diagram below; for more information see page 28

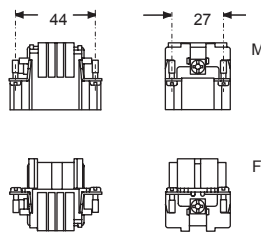

contacts side (front view)

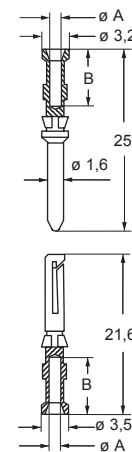
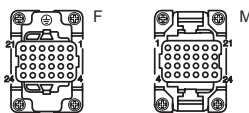

**RDF2D and RDM2D contacts**

conductor section mm <sup>2</sup>	conductor slot ø A (mm)	conductors stripping length B (mm)
0,14-0,37	0,9	8
0,5	1,1	8
0,75	1,3	8
1,0	1,45	8
1,5	1,8	8
2,5	2,2	6

**RDD 24 poles connector inserts**  
**Maximum current load derating diagram**

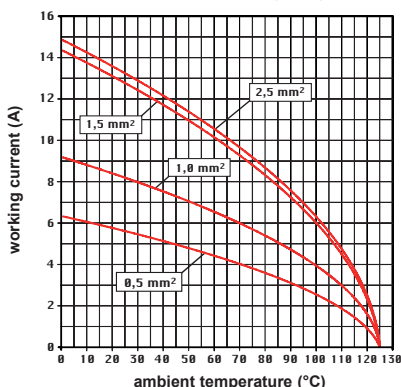

CR CP coding pin  
with loss of one contact  
(page 684)



# RDD 42 poles + ⊕ 10A - 250V HNM (High Number of Matings)

enclosures:  
size "57.27"

page:

HNM  
C-TYPE IP65/IP66, single lever  
V-TYPE IP65/IP66, single lever

594 - 595  
393 - 401  
448 - 453

inserts, crimp connections

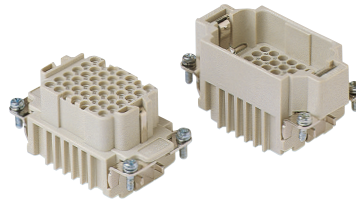

Q 10.000 MATINGS WITH HNM ENCLOSURES  
Q 5.000 MATINGS WITH STANDARD ENCLOSURES, SINGLE LEVER

10A crimp contacts  
gold plated



description	part No.	part No.
-------------	----------	----------

without contacts (to be ordered separately)  
female inserts for female contacts  
male inserts for male contacts

RDDF 42  
RDDM 42

10A female contacts

cross-section	AWG	identification No.
0,14-0,37 mm <sup>2</sup>	AWG 26-22	identification No. 1
0,5 mm <sup>2</sup>	AWG 20	identification No. 2
0,75 mm <sup>2</sup>	AWG 18	identification No. ②
1 mm <sup>2</sup>	AWG 18	identification No. 3
1,5 mm <sup>2</sup>	AWG 16	identification No. 4
2,5 mm <sup>2</sup>	AWG 14	identification No. 5

RDF2D 0.3  
RDF2D 0.5  
RDF2D 0.7  
RDF2D 1.0  
RDF2D 1.5  
RDF2D 2.5

gold plated+

10A male contacts

cross-section	AWG	identification No.
0,14-0,37 mm <sup>2</sup>	AWG 26-22	identification No. 1
0,5 mm <sup>2</sup>	AWG 20	identification No. 2
0,75 mm <sup>2</sup>	AWG 18	identification No. ②
1 mm <sup>2</sup>	AWG 18	identification No. 3
1,5 mm <sup>2</sup>	AWG 16	identification No. 4
2,5 mm <sup>2</sup>	AWG 14	identification No. 5

RDM2D 0.3  
RDM2D 0.5  
RDM2D 0.7  
RDM2D 1.0  
RDM2D 1.5  
RDM2D 2.5

- characteristics according to EN 61984:

**10A 250V 4kV 2**

- certified
- insulation resistance:  $\geq 10 \text{ G}\Omega$
- ambient temperature limit:  $-40 \text{ }^\circ\text{C} \dots +125 \text{ }^\circ\text{C}$
- made of self-extinguishing thermoplastic resin UL 94V-0
- mechanical life:  $\geq 10.000$  cycles
- contact resistance:  $\leq 3 \text{ m}\Omega$
- for applications requiring higher voltages, please see the special voltage application section on page 75
- **it is recommended to crimp the contacts with crimping tools homologated by ILME** (please see the crimping tool section 10A contacts, RDF2D and RDM2D series) on pages 705 - 741
- PCBs interface, see article CIF 2.4
- for max. current load see the connector inserts derating diagram below; for more information see page 28

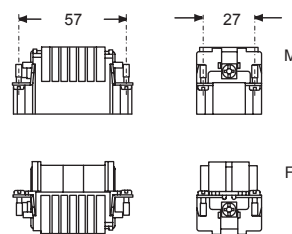

contacts side (front view)

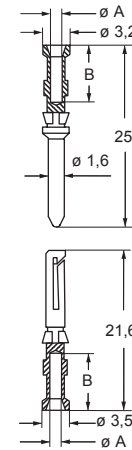
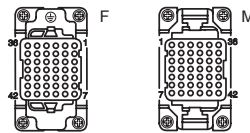

RDF2D and RDM2D contacts

conductor section mm <sup>2</sup>	conductor slot $\phi A$ (mm)	conductors stripping length B (mm)
0,14-0,37	0,9	8
0,5	1,1	8
0,75	1,3	8
1,0	1,45	8
1,5	1,8	8
2,5	2,2	6

RDD 42 poles connector inserts  
Maximum current load derating diagram

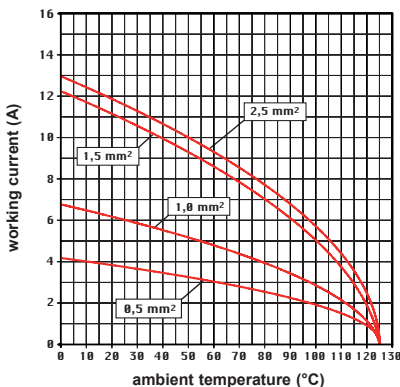

CR CP coding pin with loss of one contact (page 684)



# RDD 72 poles + ⊕ 10A - 250V HNM (High Number of Matings)

enclosures:  
size "77.27"

page:

HNM  
C-TYPE IP65/IP66, single lever  
V-TYPE IP65/IP66, single lever

596 - 597  
402 - 411  
454 - 458

inserts, crimp connections

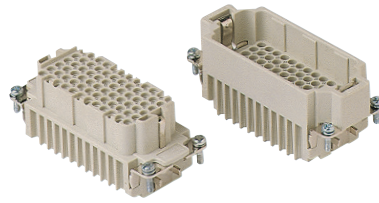

10A crimp contacts  
gold plated



Q 10.000 MATINGS WITH HNM ENCLOSURES

Q 5.000 MATINGS WITH STANDARD ENCLOSURES, SINGLE LEVER

description

part No.

part No.

without contacts (to be ordered separately)  
female inserts for female contacts  
male inserts for male contacts

RDDF 72  
RDDM 72

10A female contacts

0,14-0,37 mm <sup>2</sup>	AWG 26-22	identification No. 1
0,5 mm <sup>2</sup>	AWG 20	identification No. 2
0,75 mm <sup>2</sup>	AWG 18	identification No. ②
1 mm <sup>2</sup>	AWG 18	identification No. 3
1,5 mm <sup>2</sup>	AWG 16	identification No. 4
2,5 mm <sup>2</sup>	AWG 14	identification No. 5

RDF2D 0.3  
RDF2D 0.5  
RDF2D 0.7  
RDF2D 1.0  
RDF2D 1.5  
RDF2D 2.5

gold plated

10A male contacts

0,14-0,37 mm <sup>2</sup>	AWG 26-22	identification No. 1
0,5 mm <sup>2</sup>	AWG 20	identification No. 2
0,75 mm <sup>2</sup>	AWG 18	identification No. ②
1 mm <sup>2</sup>	AWG 18	identification No. 3
1,5 mm <sup>2</sup>	AWG 16	identification No. 4
2,5 mm <sup>2</sup>	AWG 14	identification No. 5

RDM2D 0.3  
RDM2D 0.5  
RDM2D 0.7  
RDM2D 1.0  
RDM2D 1.5  
RDM2D 2.5

- characteristics according to EN 61984:

**10A 250V 4kV 2**

- certified
- insulation resistance:  $\geq 10 \text{ G}\Omega$
- ambient temperature limit:  $-40 \text{ }^\circ\text{C} \dots +125 \text{ }^\circ\text{C}$
- made of self-extinguishing thermoplastic resin UL 94V-0
- mechanical life:  $\geq 10.000$  cycles
- contact resistance:  $\leq 3 \text{ m}\Omega$
- for applications requiring higher voltages, please see the special voltage application section on page 75
- **it is recommended to crimp the contacts with crimping tools homologated by ILME** (please see the crimping tool section 10A contacts, RDF2D and RDM2D series) on pages 705 - 741
- PCBs interface, see article CIF 2.4
- for max. current load see the connector inserts derating diagram below; for more information see page 28

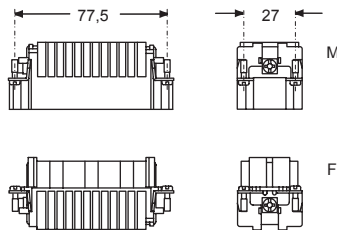

contacts side (front view)

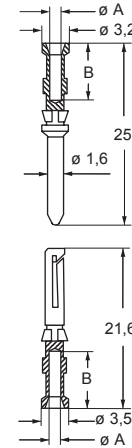
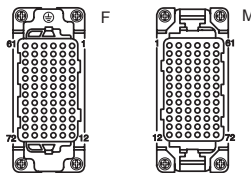

RDF2D and RDM2D contacts

conductor section mm <sup>2</sup>	conductor slot Ø A (mm)	conductors stripping length B (mm)
0,14-0,37	0,9	8
0,5	1,1	8
0,75	1,3	8
1,0	1,45	8
1,5	1,8	8
2,5	2,2	6

RDD 72 poles connector inserts  
Maximum current load derating diagram

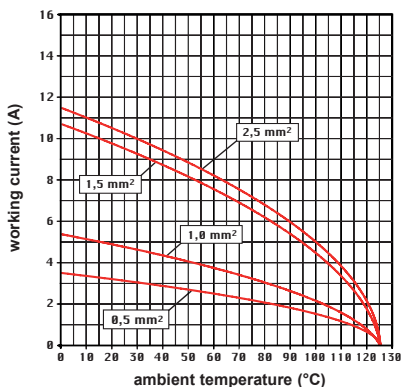

CR CP coding pin with loss of one contact (page 684)





# RDD 108 poles + ⊕ 10A - 250V HNM (High Number of Matings)

enclosures:  
size "104.27"

page:

HNM  
C-TYPE IP65/IP66, single lever  
V-TYPE IP65/IP66, single lever

598 - 599  
412 - 423  
459 - 463

inserts, crimp connections

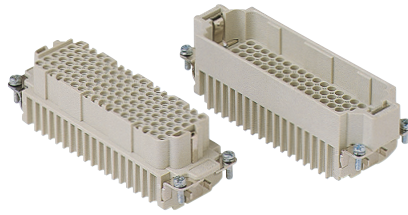

10A crimp contacts  
gold plated



Q 10.000 MATINGS WITH HNM ENCLOSURES

Q 5.000 MATINGS WITH STANDARD ENCLOSURES, SINGLE LEVER

description	part No.	part No.
-------------	----------	----------

without contacts (to be ordered separately)  
female inserts for female contacts  
male inserts for male contacts

RDDF 108  
RDDM 108

10A female contacts

0,14-0,37 mm <sup>2</sup>	AWG 26-22	identification No. 1
0,5 mm <sup>2</sup>	AWG 20	identification No. 2
0,75 mm <sup>2</sup>	AWG 18	identification No. ②
1 mm <sup>2</sup>	AWG 18	identification No. 3
1,5 mm <sup>2</sup>	AWG 16	identification No. 4
2,5 mm <sup>2</sup>	AWG 14	identification No. 5

RDF2D 0.3  
RDF2D 0.5  
RDF2D 0.7  
RDF2D 1.0  
RDF2D 1.5  
RDF2D 2.5

gold plated+

10A male contacts

0,14-0,37 mm <sup>2</sup>	AWG 26-22	identification No. 1
0,5 mm <sup>2</sup>	AWG 20	identification No. 2
0,75 mm <sup>2</sup>	AWG 18	identification No. ②
1 mm <sup>2</sup>	AWG 18	identification No. 3
1,5 mm <sup>2</sup>	AWG 16	identification No. 4
2,5 mm <sup>2</sup>	AWG 14	identification No. 5

RDM2D 0.3  
RDM2D 0.5  
RDM2D 0.7  
RDM2D 1.0  
RDM2D 1.5  
RDM2D 2.5

- characteristics according to EN 61984:

**10A 250V 4kV 2**

- certified
- insulation resistance:  $\geq 10 \text{ G}\Omega$
- ambient temperature limit:  $-40 \text{ }^\circ\text{C} \dots +125 \text{ }^\circ\text{C}$
- made of self-extinguishing thermoplastic resin UL 94V-0
- mechanical life:  $\geq 10.000$  cycles
- contact resistance:  $\leq 3 \text{ m}\Omega$
- for applications requiring higher voltages, please see the special voltage application section on page 75
- **it is recommended to crimp the contacts with crimping tools homologated by ILME** (please see the crimping tool section 10A contacts, RDF2D and RDM2D series) on pages 705 - 741
- PCBs interface, see article CIF 2.4
- for max. current load see the connector inserts derating diagram below; for more information see page 28

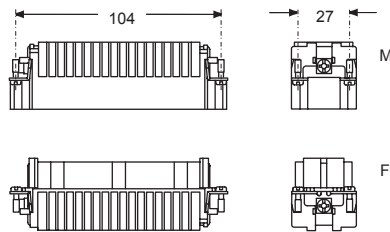

contacts side (front view)

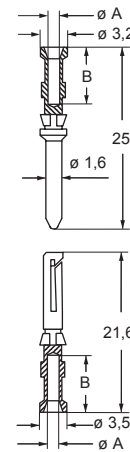
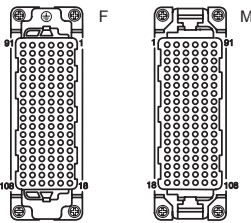

RDF2D and RDM2D contacts

conductor section mm <sup>2</sup>	conductor slot ø A (mm)	conductors stripping length B (mm)
0,14-0,37	0,9	8
0,5	1,1	8
0,75	1,3	8
1,0	1,45	8
1,5	1,8	8
2,5	2,2	6

RDD 108 poles connector inserts  
Maximum current load derating diagram

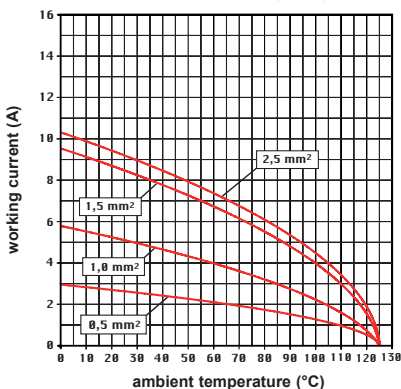

CR CP coding pin with loss of one contact (page 684)



**RCE 6 poles + ⊕ 16A - 500V HNM (High Number of Matings)**

enclosures:  
size "44.27"

page:

HNM

592 - 593

inserts, crimp connections

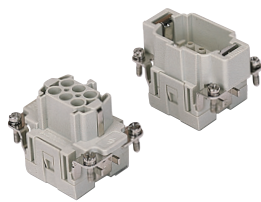

16A crimp contacts  
gold plated



**Q 10.000 MATINGS WITH HNM ENCLOSURES**

description

part No.

part No.

without contacts (to be ordered separately)  
female inserts for female contacts  
male inserts for male contacts

**RCEF 06**  
**RCEM 06**

16A female contacts

0,14-0,37 mm <sup>2</sup>	AWG 26-22	one groove
0,5 mm <sup>2</sup>	AWG 20	with no grooves
0,75 mm <sup>2</sup>	AWG 18	one groove (back side)
1 mm <sup>2</sup>	AWG 18	one groove
1,5 mm <sup>2</sup>	AWG 16	two grooves
2,5 mm <sup>2</sup>	AWG 14	three grooves
3 mm <sup>2</sup>	AWG 12	one wide groove
4 mm <sup>2</sup>	AWG 12	with no grooves

**RCF2D 0.3**  
**RCF2D 0.5**  
**RCF2D 0.7**  
**RCF2D 1.0**  
**RCF2D 1.5**  
**RCF2D 2.5**  
**RCF2D 3.0**  
**RCF2D 4.0**

gold plated

16A male contacts

0,14-0,37 mm <sup>2</sup>	AWG 26-22	one groove
0,5 mm <sup>2</sup>	AWG 20	with no grooves
0,75 mm <sup>2</sup>	AWG 18	one groove (back side)
1 mm <sup>2</sup>	AWG 18	one groove
1,5 mm <sup>2</sup>	AWG 16	two grooves
2,5 mm <sup>2</sup>	AWG 14	three grooves
3 mm <sup>2</sup>	AWG 12	one wide groove
4 mm <sup>2</sup>	AWG 12	with no grooves

**RCM2D 0.3**  
**RCM2D 0.5**  
**RCM2D 0.7**  
**RCM2D 1.0**  
**RCM2D 1.5**  
**RCM2D 2.5**  
**RCM2D 3.0**  
**RCM2D 4.0**

- characteristics according to EN 61984:

**16A 500V 6kV 3**  
**16A 400/690V 6kV 2**

- certified
- insulation resistance:  $\geq 10 \text{ G}\Omega$
- ambient temperature limit:  $-40 \text{ }^\circ\text{C} \dots +125 \text{ }^\circ\text{C}$
- made of self-extinguishing thermoplastic resin UL 94V-0
- mechanical life:  $\geq 10.000$  cycles
- contact resistance:  $\leq 1 \text{ m}\Omega$
- **it is recommended to crimp the contacts with crimping tools homologated by ILME** (please see the crimping tool section 16A contacts, RCF2D and RCM2D series) on pages 705 - 741
- for max. current load see the connector inserts derating diagram below; for more information see page 28

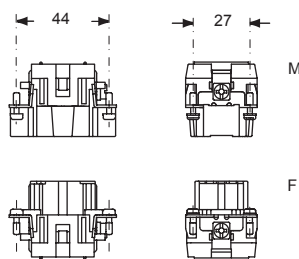

contacts side (front view)

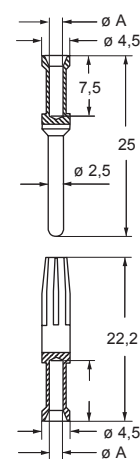
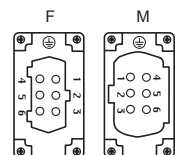

**RCF2D and RCM2D contacts**

conductor section mm <sup>2</sup>	conductor slot $\varnothing A$ (mm)	conductors stripping length (mm)
0,14-0,37	0,9	7,5
0,5	1,1	7,5
0,75	1,3	7,5
1,0	1,45	7,5
1,5	1,8	7,5
2,5	2,2	7,5
3	2,55	7,5
4	2,85	7,5

**RCE 06 poles connector inserts**  
**Maximum current load derating diagram**

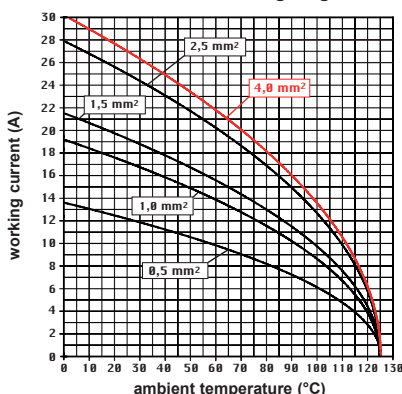

# RCE 10 poles + ⊕ 16A - 500V HNM (High Number of Matings)

enclosures:  
size "57.27"

page:

HNM  
C-TYPE IP65/IP66, single lever  
V-TYPE IP65/IP66, single lever

594 - 595  
393 - 401  
448 - 453

inserts, crimp connections

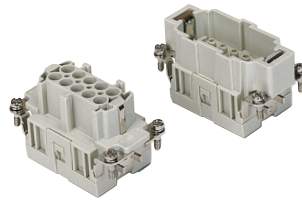

**Q 10.000 MATINGS WITH HNM ENCLOSURES**  
**Q 5.000 MATINGS WITH STANDARD ENCLOSURES, SINGLE LEVER**

16A crimp contacts  
gold plated



description	part No.	part No.
-------------	----------	----------

without contacts (to be ordered separately)  
female inserts for female contacts  
male inserts for male contacts

RCEF 10  
RCEM 10

16A female contacts

Area (mm²)	AWG	Configuration
0,14-0,37	26-22	one groove
0,5	20	with no grooves
0,75	18	one groove (back side)
1	18	one groove
1,5	16	two grooves
2,5	14	three grooves
3	12	one wide groove
4	12	with no grooves

RCF2D 0.3  
RCF2D 0.5  
RCF2D 0.7  
RCF2D 1.0  
RCF2D 1.5  
RCF2D 2.5  
RCF2D 3.0  
RCF2D 4.0

gold plated+

16A male contacts

Area (mm²)	AWG	Configuration
0,14-0,37	26-22	one groove
0,5	20	with no grooves
0,75	18	one groove (back side)
1	18	one groove
1,5	16	two grooves
2,5	14	three grooves
3	12	one wide groove
4	12	with no grooves

RCM2D 0.3  
RCM2D 0.5  
RCM2D 0.7  
RCM2D 1.0  
RCM2D 1.5  
RCM2D 2.5  
RCM2D 3.0  
RCM2D 4.0

- characteristics according to EN 61984:

**16A 500V 6kV 3**  
**16A 400/690V 6kV 2**

- certified
- insulation resistance:  $\geq 10 \text{ G}\Omega$
- ambient temperature limit:  $-40 \text{ }^\circ\text{C} \dots +125 \text{ }^\circ\text{C}$
- made of self-extinguishing thermoplastic resin UL 94V-0
- mechanical life:  $\geq 10.000$  cycles
- contact resistance:  $\leq 1 \text{ m}\Omega$
- **it is recommended to crimp the contacts with crimping tools homologated by ILME** (please see the crimping tool section 16A contacts, RCF2D and RCM2D series) on pages 705 - 741
- for max. current load see the connector inserts derating diagram below; for more information see page 28

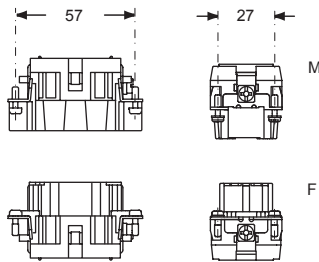

contacts side (front view)

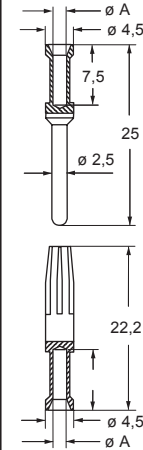
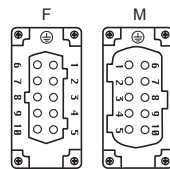

**RCF2D and RCM2D contacts**

conductor section mm²	conductor slot $\varnothing A$ (mm)	conductors stripping length (mm)
0,14-0,37	0,9	7,5
0,5	1,1	7,5
0,75	1,3	7,5
1,0	1,45	7,5
1,5	1,8	7,5
2,5	2,2	7,5
3	2,55	7,5
4	2,85	7,5

**RCE 10 poles connector inserts**  
**Maximum current load derating diagram**

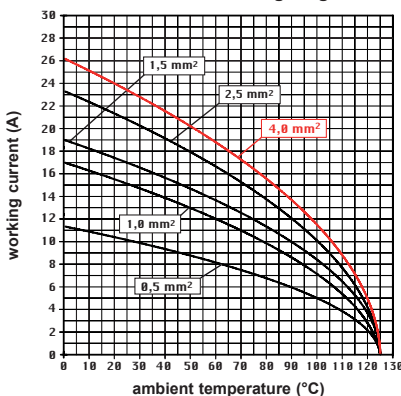

# RCE 16 poles + ⊕ 16A - 500V HNM (High Number of Matings)

enclosures:  
size "77.27"

page:

HNM  
C-TYPE IP65/IP66, single lever  
V-TYPE IP65/IP66, single lever

596 - 597  
402 - 411  
454 - 458

inserts, crimp connections

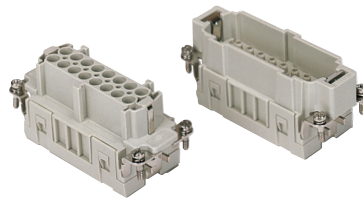

Q 10.000 MATINGS WITH HNM ENCLOSURES

Q 5.000 MATINGS WITH STANDARD ENCLOSURES, SINGLE LEVER

16A crimp contacts  
gold plated



description

part No.

part No.

without contacts (to be ordered separately)  
female inserts for female contacts  
male inserts for male contacts

RCEF 16  
RCEF 16

16A female contacts

0,14-0,37 mm <sup>2</sup>	AWG 26-22	one groove
0,5 mm <sup>2</sup>	AWG 20	with no grooves
0,75 mm <sup>2</sup>	AWG 18	one groove (back side)
1 mm <sup>2</sup>	AWG 18	one groove
1,5 mm <sup>2</sup>	AWG 16	two grooves
2,5 mm <sup>2</sup>	AWG 14	three grooves
3 mm <sup>2</sup>	AWG 12	one wide groove
4 mm <sup>2</sup>	AWG 12	with no grooves

RCF2D 0.3
RCF2D 0.5
RCF2D 0.7
RCF2D 1.0
RCF2D 1.5
RCF2D 2.5
RCF2D 3.0
RCF2D 4.0

gold plated

16A male contacts

0,14-0,37 mm <sup>2</sup>	AWG 26-22	one groove
0,5 mm <sup>2</sup>	AWG 20	with no grooves
0,75 mm <sup>2</sup>	AWG 18	one groove (back side)
1 mm <sup>2</sup>	AWG 18	one groove
1,5 mm <sup>2</sup>	AWG 16	two grooves
2,5 mm <sup>2</sup>	AWG 14	three grooves
3 mm <sup>2</sup>	AWG 12	one wide groove
4 mm <sup>2</sup>	AWG 12	with no grooves

RCM2D 0.3
RCM2D 0.5
RCM2D 0.7
RCM2D 1.0
RCM2D 1.5
RCM2D 2.5
RCM2D 3.0
RCM2D 4.0

- characteristics according to EN 61984:

**16A 500V 6kV 3**  
**16A 400/690V 6kV 2**

- BUREAU VERITAS ERE certified
- insulation resistance:  $\geq 10 \text{ G}\Omega$
- ambient temperature limit:  $-40 \text{ }^\circ\text{C} \dots +125 \text{ }^\circ\text{C}$
- made of self-extinguishing thermoplastic resin UL 94V-0
- mechanical life:  $\geq 10.000$  cycles
- contact resistance:  $\leq 1 \text{ m}\Omega$
- it is recommended to crimp the contacts with crimping tools homologated by ILME (please see the crimping tool section 16A contacts, RCF2D and RCM2D series) on pages 705 - 741
- for max. current load see the connector inserts derating diagram below; for more information see page 28

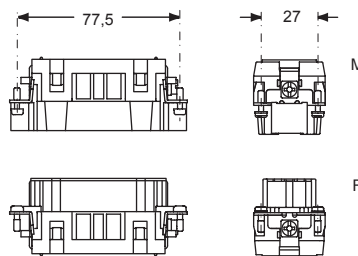

contacts side (front view)

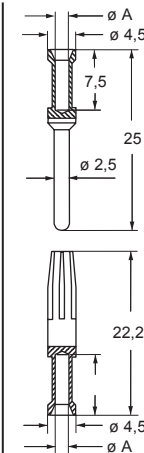
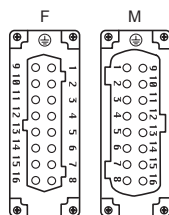

RCF2D and RCM2D contacts

conductor section mm <sup>2</sup>	conductor slot ø A (mm)	conductors stripping length (mm)
0,14-0,37	0,9	7,5
0,5	1,1	7,5
0,75	1,3	7,5
1,0	1,45	7,5
1,5	1,8	7,5
2,5	2,2	7,5
3	2,55	7,5
4	2,85	7,5

RCE 16 poles connector inserts  
Maximum current load derating diagram

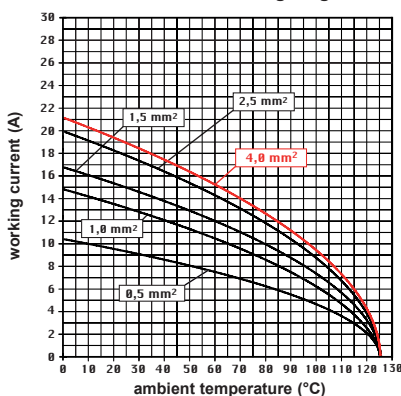

# RCE 24 poles + ⊕ 16A - 500V HNM (High Number of Matings)

enclosures:  
size "104.27"

page:

HNM  
C-TYPE IP65/IP66, single lever  
V-TYPE IP65/IP66, single lever

598 - 599  
412 - 423  
459 - 463

inserts, crimp connections

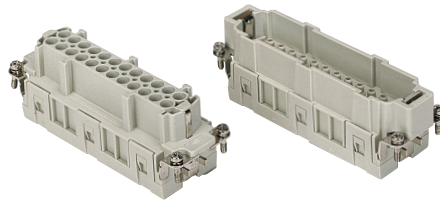

16A crimp contacts  
gold plated



Q 10.000 MATINGS WITH HNM ENCLOSURES

Q 5.000 MATINGS WITH STANDARD ENCLOSURES, SINGLE LEVER

description	part No.	part No.
-------------	----------	----------

without contacts (to be ordered separately)  
female inserts for female contacts  
male inserts for male contacts

RCEF 24  
RCEM 24

16A female contacts

Area (mm²)	AWG	Configuration
0,14-0,37	26-22	one groove
0,5	20	with no grooves
0,75	18	one groove (back side)
1	18	one groove
1,5	16	two grooves
2,5	14	three grooves
3	12	one wide groove
4	12	with no grooves

RCF2D 0.3  
RCF2D 0.5  
RCF2D 0.7  
RCF2D 1.0  
RCF2D 1.5  
RCF2D 2.5  
RCF2D 3.0  
RCF2D 4.0

gold plated+

16A male contacts

Area (mm²)	AWG	Configuration
0,14-0,37	26-22	one groove
0,5	20	with no grooves
0,75	18	one groove (back side)
1	18	one groove
1,5	16	two grooves
2,5	14	three grooves
3	12	one wide groove
4	12	with no grooves

RCM2D 0.3  
RCM2D 0.5  
RCM2D 0.7  
RCM2D 1.0  
RCM2D 1.5  
RCM2D 2.5  
RCM2D 3.0  
RCM2D 4.0

- characteristics according to EN 61984:

**16A 500V 6kV 3**  
**16A 400/690V 6kV 2**

- BUREAU VERITAS ENEC certified
- insulation resistance:  $\geq 10 \text{ G}\Omega$
- ambient temperature limit:  $-40 \text{ }^\circ\text{C} \dots +125 \text{ }^\circ\text{C}$
- made of self-extinguishing thermoplastic resin UL 94V-0
- mechanical life:  $\geq 10.000$  cycles
- contact resistance:  $\leq 1 \text{ m}\Omega$
- it is recommended to crimp the contacts with crimping tools homologated by ILME (please see the crimping tool section 16A contacts, RCF2D and RCM2D series) on pages 705 - 741
- for max. current load see the connector inserts derating diagram below; for more information see page 28

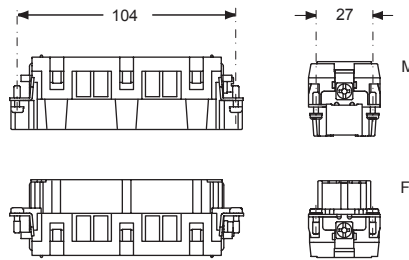

contacts side (front view)

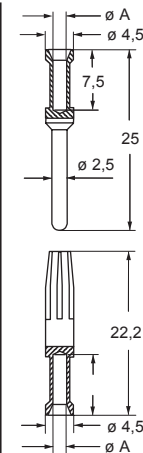
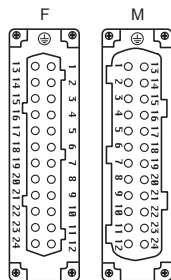

RCF2D and RCM2D contacts

conductor section mm²	conductor slot ø A (mm)	conductors stripping length (mm)
0,14-0,37	0,9	7,5
0,5	1,1	7,5
0,75	1,3	7,5
1,0	1,45	7,5
1,5	1,8	7,5
2,5	2,2	7,5
3	2,55	7,5
4	2,85	7,5

RCE 24 poles connector inserts  
Maximum current load derating diagram

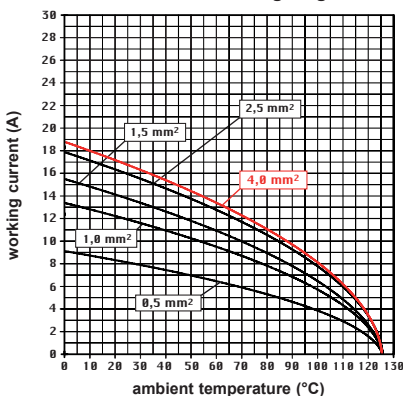

# RQEE 40 poles + ⊕ 16A - 500V HNM (High Number of Matings)

enclosures:  
size "77.27"

page:

HNM  
C-TYPE IP65/IP66, single lever  
V-TYPE IP65/IP66, single lever

596 - 597  
402 - 411  
454 - 458

inserts, crimp connections

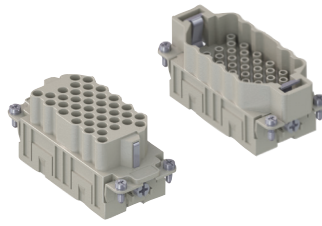

**Q 10.000 MATINGS WITH HNM ENCLOSURES**

**Q 5.000 MATINGS WITH STANDARD ENCLOSURES, SINGLE LEVER**

16A crimp contacts  
gold plated



description

part No.

part No.

without contacts (to be ordered separately)  
female inserts for female contacts  
male inserts for male contacts

RQEEF 40  
RQEEM 40

16A female contacts

0,14-0,37 mm <sup>2</sup>	AWG 26-22	one groove
0,5 mm <sup>2</sup>	AWG 20	with no grooves
0,75 mm <sup>2</sup>	AWG 18	one groove (back side)
1 mm <sup>2</sup>	AWG 18	one groove
1,5 mm <sup>2</sup>	AWG 16	two grooves
2,5 mm <sup>2</sup>	AWG 14	three grooves
3 mm <sup>2</sup>	AWG 12	one wide groove
4 mm <sup>2</sup>	AWG 12	with no grooves

RCF2D 0.3
RCF2D 0.5
RCF2D 0.7
RCF2D 1.0
RCF2D 1.5
RCF2D 2.5
RCF2D 3.0
RCF2D 4.0

gold plated

16A male contacts

0,14-0,37 mm <sup>2</sup>	AWG 26-22	one groove
0,5 mm <sup>2</sup>	AWG 20	with no grooves
0,75 mm <sup>2</sup>	AWG 18	one groove (back side)
1 mm <sup>2</sup>	AWG 18	one groove
1,5 mm <sup>2</sup>	AWG 16	two grooves
2,5 mm <sup>2</sup>	AWG 14	three grooves
3 mm <sup>2</sup>	AWG 12	one wide groove
4 mm <sup>2</sup>	AWG 12	with no grooves

RCM2D 0.3
RCM2D 0.5
RCM2D 0.7
RCM2D 1.0
RCM2D 1.5
RCM2D 2.5
RCM2D 3.0
RCM2D 4.0

- characteristics according to EN 61984:

**16A 500V 6kV 3**

- DNV-GL BUREAU VERITAS EAC certified

- insulation resistance:  $\geq 10 \text{ G}\Omega$

- ambient temperature limit:  $-40 \text{ }^\circ\text{C} \dots +125 \text{ }^\circ\text{C}$

- made of self-extinguishing thermoplastic resin  
UL 94V-0

- mechanical life:  $\geq 10.000$  cycles

- contact resistance:  $\leq 1 \text{ m}\Omega$

- **it is recommended to crimp the contacts with crimping tools homologated by ILME** (please see the crimping tool section 16A contacts, RCF2D and RCM2D series) on pages 705 - 741

- for max. current load see the connector inserts derating diagram below; for more information see page 28

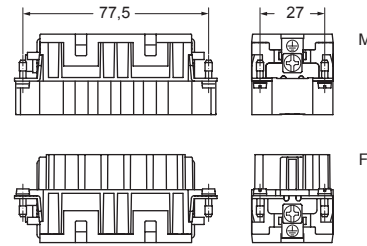

contacts side (front view)

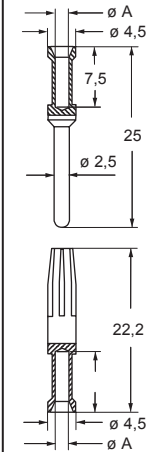
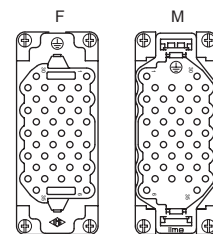

**RCF2D and RCM2D contacts**

conductor section mm <sup>2</sup>	conductor slot ø A (mm)	conductors stripping length (mm)
0,14-0,37	0,9	7,5
0,5	1,1	7,5
0,75	1,3	7,5
1,0	1,45	7,5
1,5	1,8	7,5
2,5	2,2	7,5
3	2,55	7,5
4	2,85	7,5

**RQEE 40 poles connector inserts**  
Maximum current load derating diagram

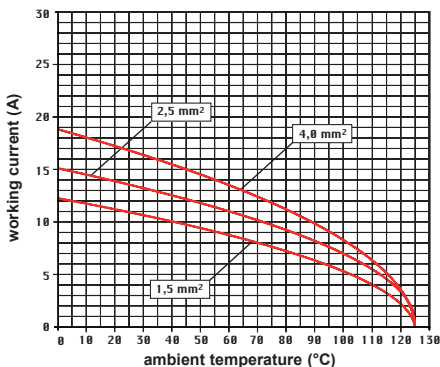

CR CPQ coding pins  
[page 689]





# RQEE 64 poles + ⊕ 16A - 500V HNM (High Number of Matings)

enclosures:  
size "104.27"

page:

HNM  
C-TYPE IP65/IP66, single lever  
V-TYPE IP65/IP66, single lever

598 - 599  
412 - 423  
459 - 463

inserts, crimp connections

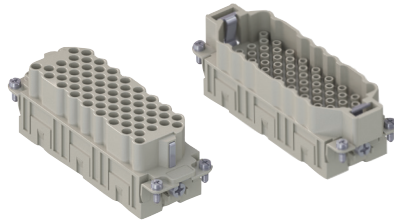

Q 10.000 MATINGS WITH HNM ENCLOSURES

Q 5.000 MATINGS WITH STANDARD ENCLOSURES, SINGLE LEVER

16A crimp contacts  
gold plated



description	part No.	part No.
-------------	----------	----------

without contacts (to be ordered separately)  
female inserts for female contacts  
male inserts for male contacts

RQEEF 64  
RQEEM 64

16A female contacts

Area (mm <sup>2</sup> )	AWG	Configuration
0,14-0,37	26-22	one groove
0,5	20	with no grooves
0,75	18	one groove (back side)
1	18	one groove
1,5	16	two grooves
2,5	14	three grooves
3	12	one wide groove
4	12	with no grooves

RCF2D 0.3  
RCF2D 0.5  
RCF2D 0.7  
RCF2D 1.0  
RCF2D 1.5  
RCF2D 2.5  
RCF2D 3.0  
RCF2D 4.0

gold plated+

16A male contacts

Area (mm <sup>2</sup> )	AWG	Configuration
0,14-0,37	26-22	one groove
0,5	20	with no grooves
0,75	18	one groove (back side)
1	18	one groove
1,5	16	two grooves
2,5	14	three grooves
3	12	one wide groove
4	12	with no grooves

RCM2D 0.3  
RCM2D 0.5  
RCM2D 0.7  
RCM2D 1.0  
RCM2D 1.5  
RCM2D 2.5  
RCM2D 3.0  
RCM2D 4.0

- characteristics according to EN 61984:

**16A 500V 6kV 3**

- BUREAU VERITAS EAC certified
- DNV-GL certified
- insulation resistance:  $\geq 10 \text{ G}\Omega$
- ambient temperature limit:  $-40 \text{ }^\circ\text{C} \dots +125 \text{ }^\circ\text{C}$
- made of self-extinguishing thermoplastic resin UL 94V-0
- mechanical life:  $\geq 10.000$  cycles
- contact resistance:  $\leq 1 \text{ m}\Omega$
- it is recommended to crimp the contacts with crimping tools homologated by ILME (please see the crimping tool section 16A contacts, RCF2D and RCM2D series) on pages 705 - 741
- for max. current load see the connector inserts derating

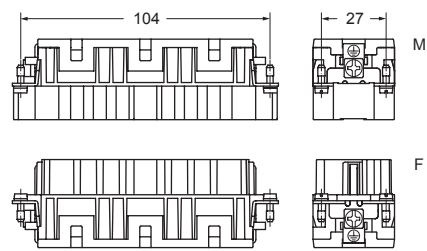

contacts side (front view)

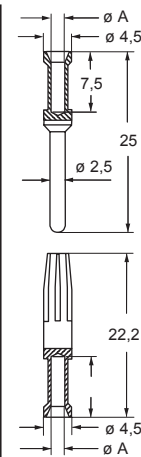
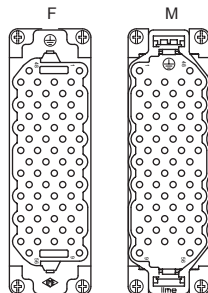

RQEE 64 poles connector inserts  
Maximum current load derating diagram

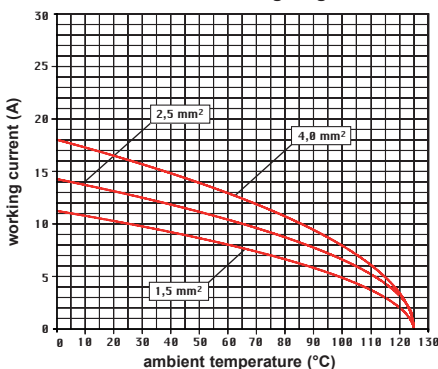

CR CPQ coding pins  
(page 689)



RCF2D and RCM2D contacts

conductor section mm <sup>2</sup>	conductor slot ø A (mm)	conductors stripping length (mm)
0,14-0,37	0,9	7,5
0,5	1,1	7,5
0,75	1,3	7,5
1,0	1,45	7,5
1,5	1,8	7,5
2,5	2,2	7,5
3	2,55	7,5
4	2,85	7,5

## RXF/M 12/2

## TECHNICAL FEATURES

- Special HNM version (**High Number of Matings** up to 10.000 cycles) of CXF/M 12/2 connector inserts, to be used in combination with:

- **up to 12 40A HNM gold plated removable crimp contacts** of the **new RX** series,
- **2 10A HNM gold plated removable crimp contacts** of the **already available RD** series;

- crimp connector inserts with a combination of 12 power contacts (40A) plus 2 auxiliary contacts (10A) + PE;

- suitable for the operation of 4 three-phase AC motors with 2 auxiliary contacts;

- featuring a special antifriction treatment to guarantee up to **10.000 mating cycles**

- **5.000 mating cycles** with standard enclosures, single lever (excluding size "44.27").

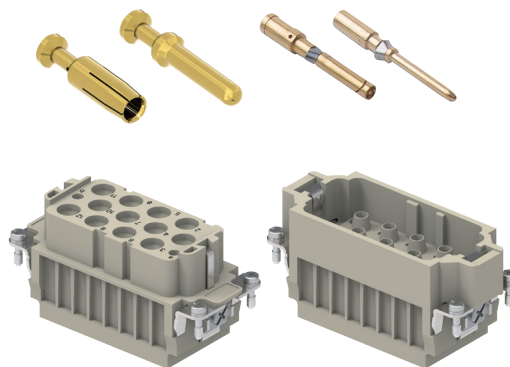

## SUM-UP

- ☑ **Crimp connection**
- ☑ **Great resistance to strong vibrations**
- ☑ **For wires: up to 10 mm<sup>2</sup> (AWG 8)**
- ☑ **Auxiliary crimp contacts: silver or gold plated**



enclosures:  
size "77.27"

page:

HNM  
C-TYPE IP65/IP66, single lever  
V-TYPE IP65/IP66, single lever

596 - 597  
402 - 411  
454 - 458

inserts, crimp connections

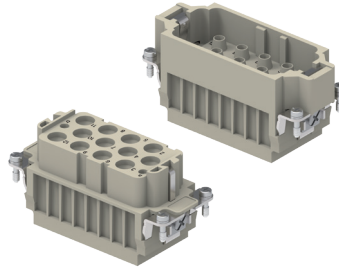

**Q 10.000 MATINGS WITH HNM ENCLOSURES**  
**Q 5.000 MATINGS WITH STANDARD ENCLOSURES, SINGLE LEVER**

40A and 10A crimp contacts  
gold plated



description	part No.	part No
-------------	----------	---------

without contacts (to be ordered separately)  
female inserts for female contacts  
male inserts for male contacts

RXF 12/2  
RXM 12/2

40A female crimp contacts  
1,5 mm<sup>2</sup> AWG 16  
2,5 mm<sup>2</sup> AWG 14  
4 mm<sup>2</sup> AWG 12  
6 mm<sup>2</sup> AWG 10

RXF2D 1.5  
RXF2D 2.5  
RXF2D 4.0  
RXF2D 6.0

gold plated

40A male crimp contacts  
1,5 mm<sup>2</sup> AWG 16  
2,5 mm<sup>2</sup> AWG 14  
4 mm<sup>2</sup> AWG 12  
6 mm<sup>2</sup> AWG 10

RXM2D 1.5  
RXM2D 2.5  
RXM2D 4.0  
RXM2D 6.0

10A female contacts

0,14-0,37 mm<sup>2</sup> AWG 26-22 identification No. 1  
0,5 mm<sup>2</sup> AWG 20 identification No. 2  
0,75 mm<sup>2</sup> AWG 18 identification No. ②  
1 mm<sup>2</sup> AWG 18 identification No. 3  
1,5 mm<sup>2</sup> AWG 16 identification No. 4  
2,5 mm<sup>2</sup> AWG 14 identification No. 5

RDF2D 0.3  
RDF2D 0.5  
RDF2D 0.7  
RDF2D 1.0  
RDF2D 1.5  
RDF2D 2.5

gold plated

10A male contacts

0,14-0,37 mm<sup>2</sup> AWG 26-22 identification No. 1  
0,5 mm<sup>2</sup> AWG 20 identification No. 2  
0,75 mm<sup>2</sup> AWG 18 identification No. ②  
1 mm<sup>2</sup> AWG 18 identification No. 3  
1,5 mm<sup>2</sup> AWG 16 identification No. 4  
2,5 mm<sup>2</sup> AWG 14 identification No. 5

RDM2D 0.3  
RDM2D 0.5  
RDM2D 0.7  
RDM2D 1.0  
RDM2D 1.5  
RDM2D 2.5

- characteristics according to EN 61984:

**40A 690V 8kV 3**  
**10A 250V 4kV 2**

- cURus, CSA, CQC, DNV-GL, BV, EAC pending
- rated voltage according to UL/CSA: 600V
- insulation resistance: ≥ 10 GΩ
- ambient temperature limit: -40 °C ... +125 °C
- made of self-extinguishing thermoplastic resin UL 94V-0
- mechanical life: ≥ 10.000 cycles
- contact resistance: ≤ 0,3 mΩ (12 poles), ≤ 1 mΩ (2 poles)
- for max. current load see the connector inserts derating diagram below; for more information see page 28

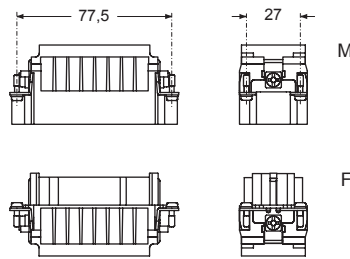

contacts side (front view)

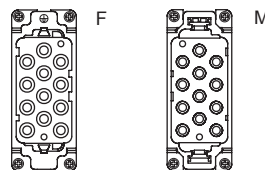

**RX 12/2 power poles connector inserts**  
**Maximum current load derating diagram**

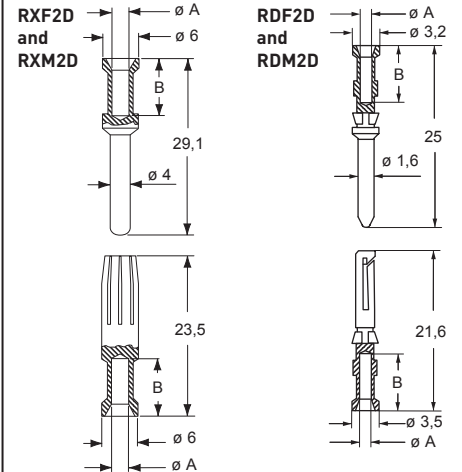
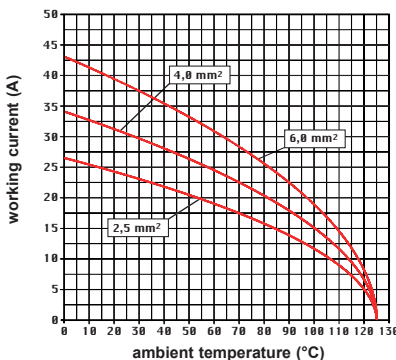

**RXF2D and RXM2D contacts**

conductor cross-sectional area mm <sup>2</sup>	conductor slot ø A (mm)	conductor stripping length B (mm)
1,5	1,8	9
2,5	2,2	9
4	2,85	9,6
6	3,5	9,6

**RDF2D and RDM2D contacts**

conductor cross-sectional area mm <sup>2</sup>	conductor slot ø A (mm)	conductor stripping length B (mm)
0,14-0,37	0,9	8
0,5	1,1	8
0,75	1,3	8
1,0	1,45	8
1,5	1,8	8
2,5	2,2	6

- it is recommended to crimp the contacts with crimping tools homologated by ILME (please see the crimping tool section 40A contacts, RXF2D, RXM2D series and 10A contacts RDF2D, RDM2D series) on pages 705 - 741



# BUILD YOUR CONNECTOR

MIXO

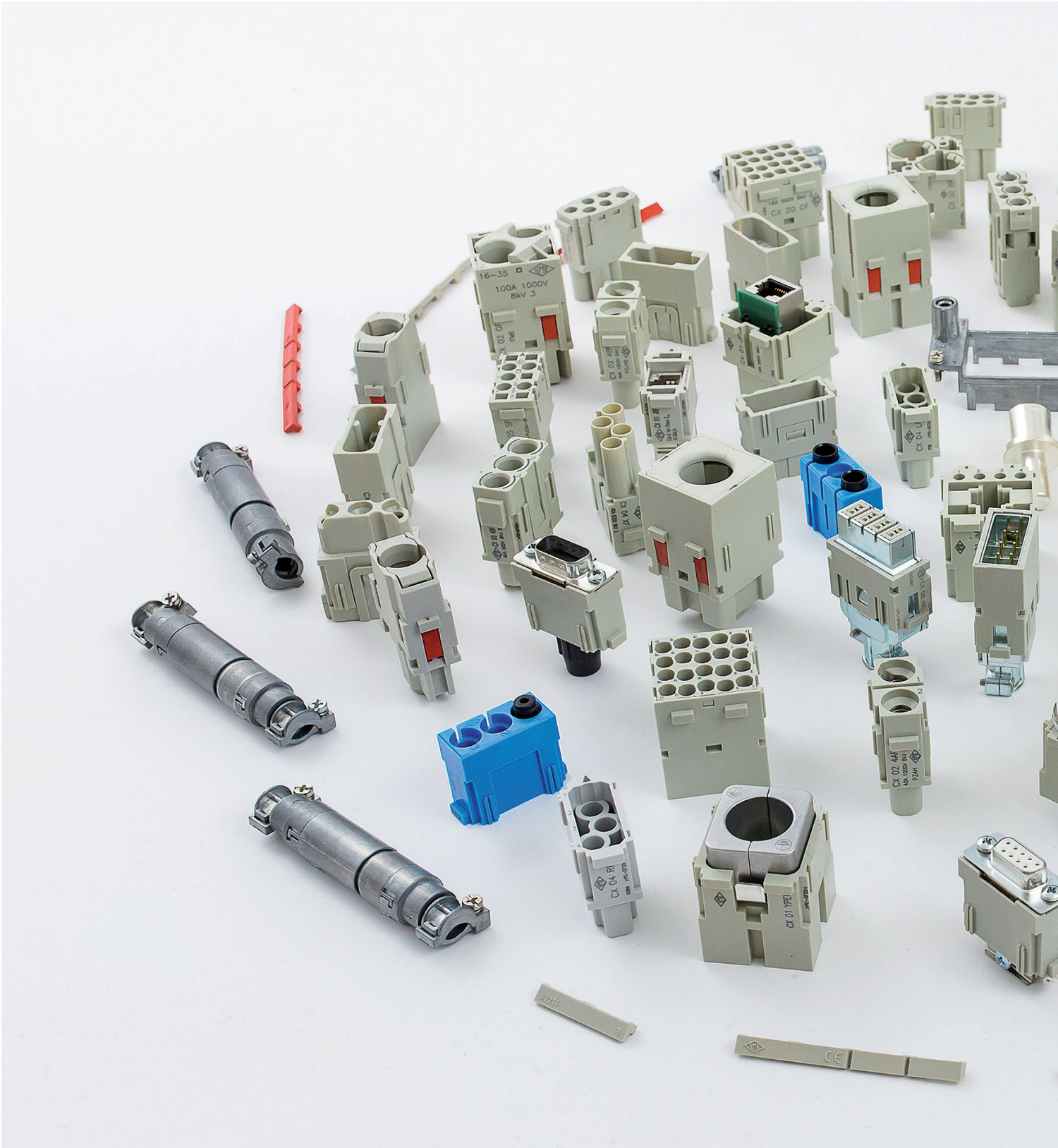



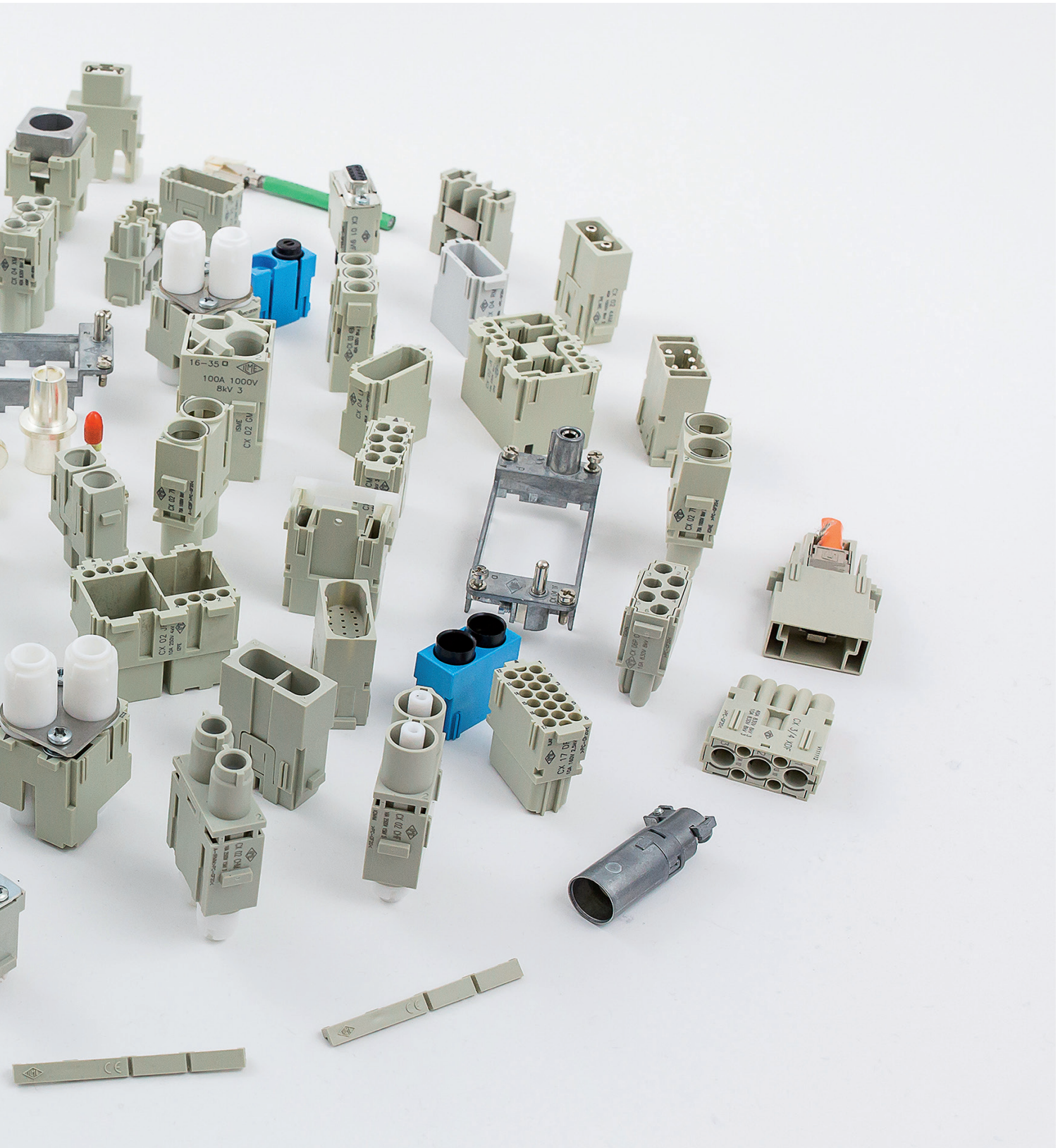

## MIXO SERIES

### GENERAL OVERVIEW

The MIXO series is a system of modular units for special applications that uses the traditional ILME enclosures. Each enclosure can house different types of connections such as: electric signals and contacts for the conduction of compressed air with pressure values of up to 8 bars.

The inserts are arranged side by side to form a single **compact block** which is inserted into metallic frames with mandatory housings. Once the modules have been inserted and locked with the special tabs, the connector can be placed into the enclosure.

The modular system makes it easy to access a series of contacts inserted in the frame (e.g., for substitution, check or the addition of signals with new inserts for needs not foreseen during the initial installation) without having to disassemble the entire connector.

ILME MIXO series of modular connectors is an open connector system that provides versatile configuration to the users' individual requirements, giving the **freedom to assemble a customized connector** from a range of almost 40 modules for power electrical, data transmission, optical signals or air. The module range is continuously expanded, allowing new configurations to be realised.

The use of enclosures provides the possibility of innumerable **applications**.

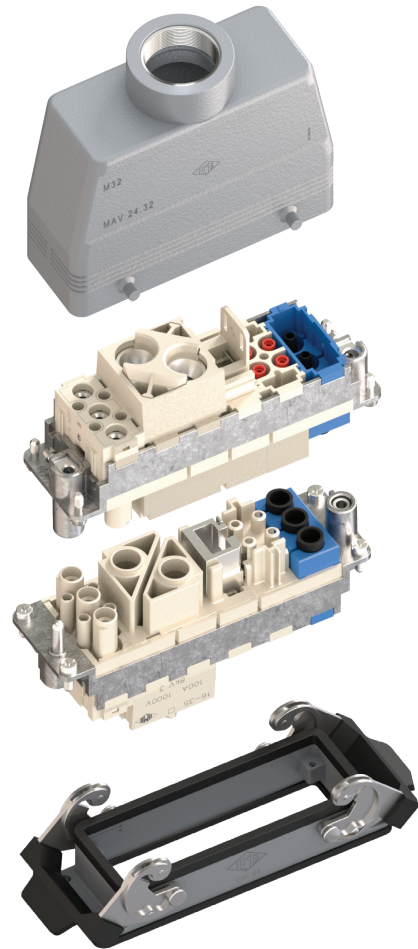

POWER/  
SIGNAL



POWER

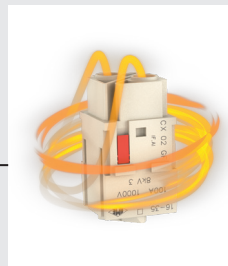

DATA  
TRANSMISSION



FIBRE OPTIC

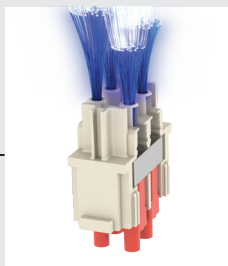

PNEUMATIC

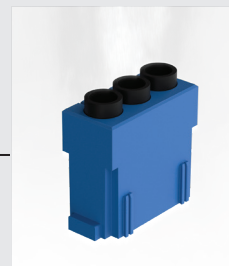



The MIXO series can be used with **5 different frame sizes:**

Frames	one or two-level metallic enclosures
<b>CX 01 T</b>	size "49.16"
<b>CX 02 TM/TF</b>	size "44.27"
<b>CX 03 TM/TF</b>	size "57.27"
<b>CX 04 TM/TF</b>	size "77.27"
<b>CX 06 TM/TF</b>	size "104.27"
<b>CX 04 TM/TF (x 2)</b>	size "77.62"
<b>CX 06 TM/TF (x 2)</b>	size "104.62"

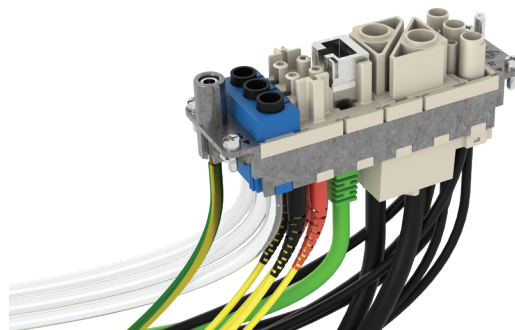

MIXO

**CX 01 T**  
1 module



**CX 02 TF/TM**  
2 modules

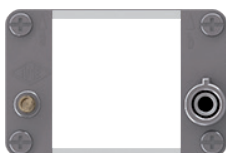

**CX 03 TF/TM**  
3 modules

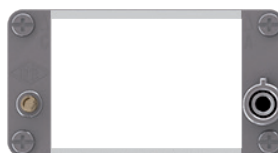

**CX 04 TF/TM**  
4 modules

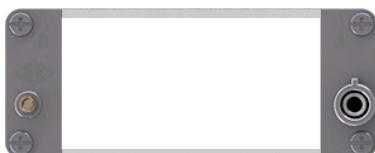

**CX 06 TF/TM**  
6 modules



Possibility – to be verified case-by-case – to use the recently added MIXO **HNM frames** (provided with special gold plated PE contacts) together with R series of crimp contacts and the relevant

connector hoods and housings, to produce, where required, an **HNM connector** (High Number of Matings, up to 10.000 cycles of operation). For more information refer to page 303

Fill the unused frame slots with **CX FM dummy module**

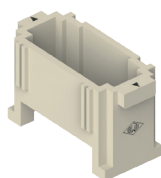

In addition, the MIXO series can be used with the **COB series panel supports**.

Frames	COB panel supports part No.
<b>CX 02 TM/TF</b>	fixed: <b>COB 06 BC</b> and <b>COB TCQ</b> mobile: <b>COB TSF, COB TSFS</b> and <b>COB 06 CMS</b>
<b>CX 03 TM/TF</b>	fixed: <b>COB 10 BC</b> and <b>COB TCQ</b> mobile: <b>COB TSF, COB TSFS</b> and <b>COB 10 CMS</b>

Frames	COB panel supports part No.
<b>CX 04 TM/TF</b>	fixed: <b>COB 16 BC</b> and <b>COB TCQ</b> mobile: <b>COB TSF, COB TSFS</b> and <b>COB 16 CMS</b>
<b>CX 06 TM/TF</b>	fixed: <b>COB 24 BC</b> and <b>COB TCQ</b> mobile: <b>COB TSF, COB TSFS</b> and <b>COB 24 CMS</b>

## THE COMPLETE RANGE

Inserts	Contact type	Signal type	Kind of connection	Rated current (A)	Rated voltage (V)	No. of frame slots	HNM suitable
CX 01 YF/M	main	electric	crimp	200	1000	2	—
CX 01 YPEF/M	PE	—	crimp	200	—	2	—
CX 01 GF/M	main	electric	crimp	100	830	1	—
CX 02 GF/M	main	electric	crimp	100	1000	2	—
CX 02 7F/M	main	electric	crimp	70	1000	1	—
CX 02 4AF/M	main	electric	axial screw	40	1000	1	—
CX 02 4BF/M	main	electric	axial screw	40	1000	1	—
CX 02 4F/M	main	electric	crimp	40	1000	1	—
CX 03 4F/M	main	electric	crimp	40	400/690	1	yes
CX 03 4BF/BM	main	electric	crimp	40	500	1	yes
CX 3/4 XDF/M	main	electric	crimp	40/10	830	1	—
CX 04 XF/M	main	electric	crimp	40	830	1	yes
CX 05 SF/M	main	electric	spring	16	400	1	—
CX 05 SHF/M	main	electric	SQUICH®-spring	16	400	1	—
CX 06 CF/M	main	electric	crimp	16	500	1	yes
CX 06P CF/M	main	electric	crimp	16	830	1	yes
CX 08 CF/M	main	electric	crimp	16	400	1	yes
CX 08 I6F/M	main	electric	crimp	5	50	1	—
CX 20 CF/M	main	electric	crimp	16	500	2	yes
CX 12 DF/M	main / auxiliary	electric	crimp	10	250	1	yes
CX 17 DF/M	main / auxiliary	electric	crimp	10	160	1	yes
CX 42 DF/M	main / auxiliary	electric	crimp	10	150	2	yes
CX 25 IBF/M	main / auxiliary	electric	crimp	4	50	1	—
CX 25 IF/M	main / auxiliary	electric	crimp	4	50	1	—
CX 02 CHF/M	main	electric	crimp	16	2500	1	—
CX 02 HF/M	main	electric	crimp	16	2900/5000	2	—
CX 02 BF/M	seat for two shielded connectors (refer to CX 04 B, CX 01 B, CX 01 BC, CX 08 B)					2	—
CX 01 BCF/M	main / auxiliary + shield	electric	crimp	16	50	—	—
CX 01 BF/M	main / auxiliary + shield	electric	crimp	10	50	—	—
CX 04 BF/M	main / auxiliary + shield	electric	crimp	10	50	—	—
CX 08 BF/M	main / auxiliary + shield	electric	crimp	5	50	—	—
CX 03 P	pneumatic Ø 1,6 - 3,0 - 4,0 mm	air	push-in	—	—	1	—
CX 02 P	pneumatic Ø 6,0 mm	air	push-in	—	—	1	—
CX FM	none (dummy module)	—	—	—	—	1	yes
CX 01 J8F/M/IM	RJ45	electric	crimp/IDC	—	—	1	—
CX 01 JF/M	RJ45 + auxiliary	electric	crimp	10	250	2	—
CX 02 JF/M	RJ45 + auxiliary	electric	crimp	10	250	3	—
CX 01 UF/M	USB	electric	—	—	—	1	—
CX 01 9VF/M	D-SUB	electric	crimp	5	50	1	—
CX 01 9VTF	D-SUB	electric	screw	5	50	1	—
CX 04 LF/M	POF / MOST	optic	crimp	—	—	1	—
CX 04 RF/M	coaxial	electric	crimp	—	—	1	—
CX 04 SCF/M	SC fibre optic	optic	crimp/glue	—	—	1	—

Calculate the number of frame slots taken up by the required inserts (frame slot 1, 2 or 3 modules) and select the right frame according to the number of required modules (available 1, 2, 3, 4 and 6 modules).



size: 1 frame slot

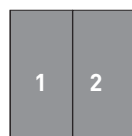

size: 2 frame slots



size: 3 frame slots

# THE 39-VARIANT RANGE OF CHOICE

ILME MIXO portfolio includes a series of key modular units being continuously widened:

<b>21 modules</b>	<b>for electric power and signal transmission</b> with contacts for rated current up to:
- 1 module for 200A	with CX 01 YF/YM and CX 01 YPEF/YPEM (for PE connection) (crimp)
- 2 modules for 100A	with CX 02 GF/GM and CX 01 GF/GM (crimp)
- 1 module for 70A	with CX 02 7F/7M (crimp)
- 7 modules for 40A	with CX 02 4F/4M (crimp), CX 02 4AF/4AM and CX 02 4BF/4BM (axial screw), with CX 03 4F/4M and CX 03 4BF/4BM (crimp), CX 3/4 XDF/XDM (crimp), CX 04 XF/XM (crimp)
- 6 modules for 16A	with CX 05 SF/SM (spring clamp), CX 05 SHF/SHM (SQUICH®), CX 06 P CF/CM, CX 06 CF/CM, CX 08 CF/CM, CX 20 CF/CM
- 3 modules for 10A	with CX 12 DF/DM (crimp), CX 17 DF/DM (crimp), CX 42 DF/DM (crimp)
- 1 module for 4A	with CX 25 IF/IM and CX 25 IBF/IBM (crimp)
<b>2 modules</b>	<b>for high voltage connections</b> 16A – 2,9/5,0 kV with CX 02 HF/HM and 2,5 kV with CX 02 CHF/ CHM
<b>4 MIXO-BUS</b>	<b>shielded connectors for bus data transmission:</b>
- 1 module CX 02 BF/BM	for two shielded connectors to be chosen among the following 4 options:
1. CX 01 BF/BM	coaxial, 10A (crimp) – 75 Ω characteristic impedance
2. CX 01 BCF/BCM	coaxial, 16A (crimp) – 50 Ω characteristic impedance
3. CX 04 BF/BM	quad-axial 10A (crimp)
4. CX 08 BF/BM	8-ways 5A (crimp)
<b>3 modules/adapters</b>	<b>for RJ-45:</b>
- CX 01 J8F/J8M/J8IM	single-sized module for 1 RJ-45 patch cord, female module is a “gender changer”
- CX 01 JF/JM	double-sized module for 1 RJ-45 patch cord + 4 auxiliary 10A (crimp) contacts
- CX 02 JF/JM	triple-sized module for 2 RJ-45 patch cords + 8 auxiliary 10A (crimp) contacts
<b>1 module</b>	<b>for Gigabit Ethernet</b> , with CX 08 I6F/ I6M, 5 A (crimp) and relevant accessories
<b>1 module/adapter</b>	<b>for USB:</b>
	male adapter for USB patch cord
	female adapter is a F/F “gender changer”, for rear connection to a male USB patch cord with CX 01 UF/ UM
<b>2 modules</b>	<b>with D-Sub 9-pole</b> with CX 01 9VF/9VM, 5A (crimp) and CX 01 9VTF (for RS-485 T-connection)
<b>2 modules</b>	<b>for pneumatic quick-couplings</b> with CX 02 P and CX 03 P
<b>3 modules</b>	<b>for fibre optic</b> (POF or MOST® or SC) or coaxial crimp contacts (50 Ω or 75 Ω characteristic impedance) with CX 04 LF/LM, CX 04 RF/RM and CX 04 SCF/SCM

In addition to:

<b>5 frames</b>	for the build-up of a modular connector. The connector consists of a multiple number of the above listed single-sized and/or double-sized modular units and/or triple-sized modules; 4 +1 frames in particular fit the main housing sizes:
- “44.27”	for 2 single-sized modules or 1 double-sized module;
- “57.27”	for 3 single-sized modules or a combination of 1 single-sized module or 1 double-sized module, or 1 triple-sized module;
- “77.27”	for 4 single-sized modules, 2 double-sized modules, 1 triple-sized module and 1 single-sized module, or a combination of 2 single-sized modules or 1 double-sized module;
- “104.27”	for 6 single-sized modules, 4 single-sized modules and 1 double-sized module, 2 single-sized modules and 2 double-sized modules, 3 double-sized modules, 2 triple-sized modules, 1 triple-sized module and 1 double-sized module and 1 single-sized module, or 1 triple-sized module and 3 single-sized modules.
<b>1 frame</b>	for the build-up of 1 single-sized module in connector housings size “49.16”.

The frame range allows the build-up of 7 different sizes of multipole modular connectors (this because 2 frames each of sizes “77.27” and “104.27” may be additionally combined in the double-sized “77.62” and “104.62” connector housings).

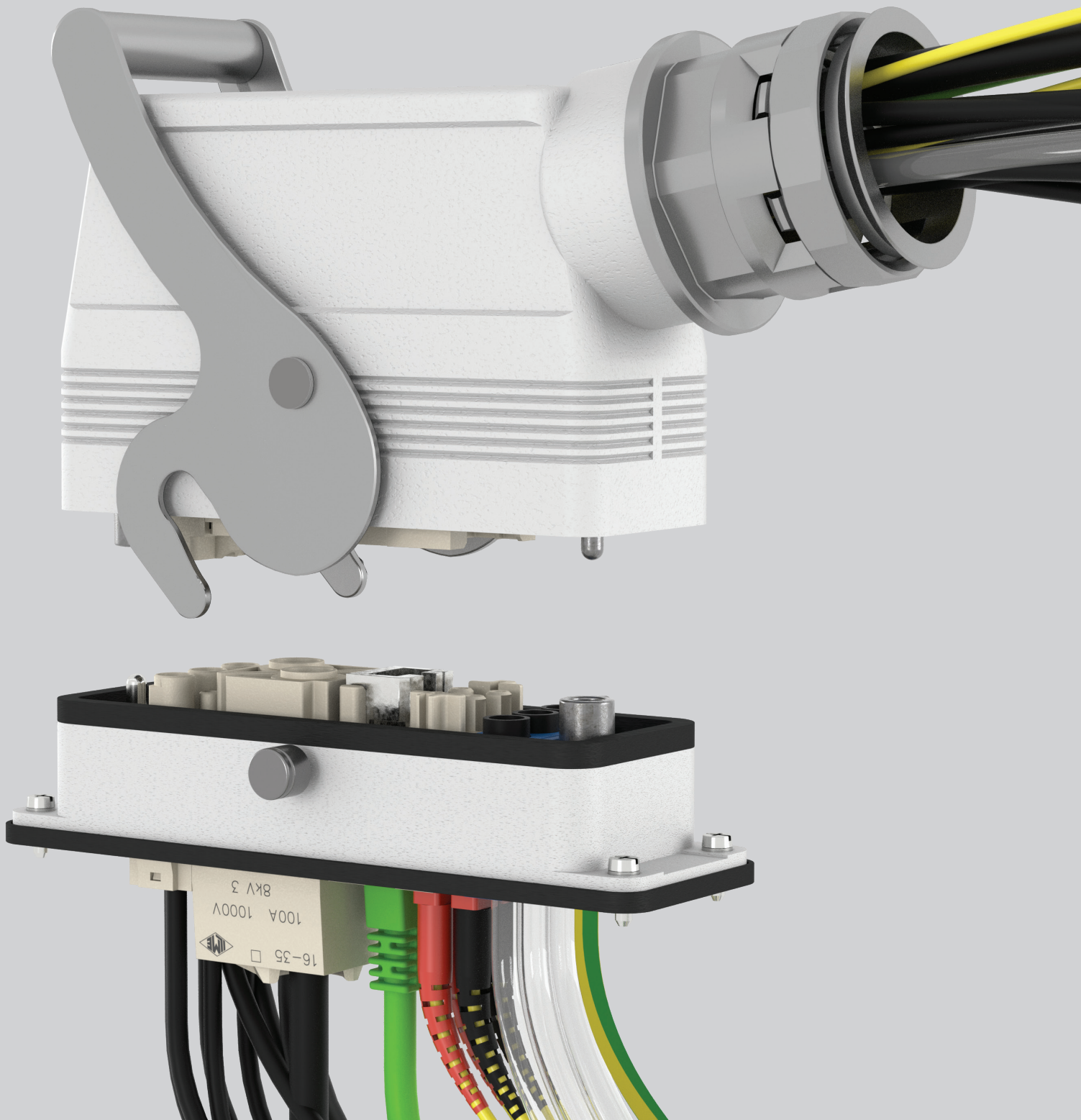

# TECHNICAL CHARACTERISTICS

- ❶ Pneumatic contacts in plastic with hose barb connection.
- ❷ Fibre optic contacts SC type.
- ❸ Electric contacts in silver-plated or gold-plated brass with connections to the conductors via crimping, spring clamp or axial screw.
- ❹ Modular inserts of identical size with insertion system for forming the complete module and frame lock tab.
- ❺ Inserts in self-extinguishing thermoplastic material, reinforced with glass fibre, UL 94V-0 approved, with a working temperature range of -40 °C to +125 °C.
- ❻ Inserts in conformance with the requirements of the EN 61984 standard and certified and marked with the UL, CSA, CQC, DNV-GL, EAC marks.
- ❼ Inserts with patented "dovetails" to prevent incorrect coupling.
- ❽ Position of contacts identified with numbers or codes on both sides of every insert.
- ❾ Male/female module carrier frames with mandatory housings and polarity, in die-cast zinc alloy.
- ❿ Module lock tab, may be divided according to the number of modules used; it guarantees a perfect stability of the modules during wiring and coupling/uncoupling of the connectors.
- ⓫ Asymmetric protective earth contacts (two per frame) with wide contact surface to prevent incorrect coupling; when two or more identical connectors of the MIXO series are used, coded pins may prevent incorrect coupling (refer to pages 684, 685 and 689).
- ⓬ Captive frame fastening screws, with spring washer.
- ⓭ Dummy module for unused frame slots.

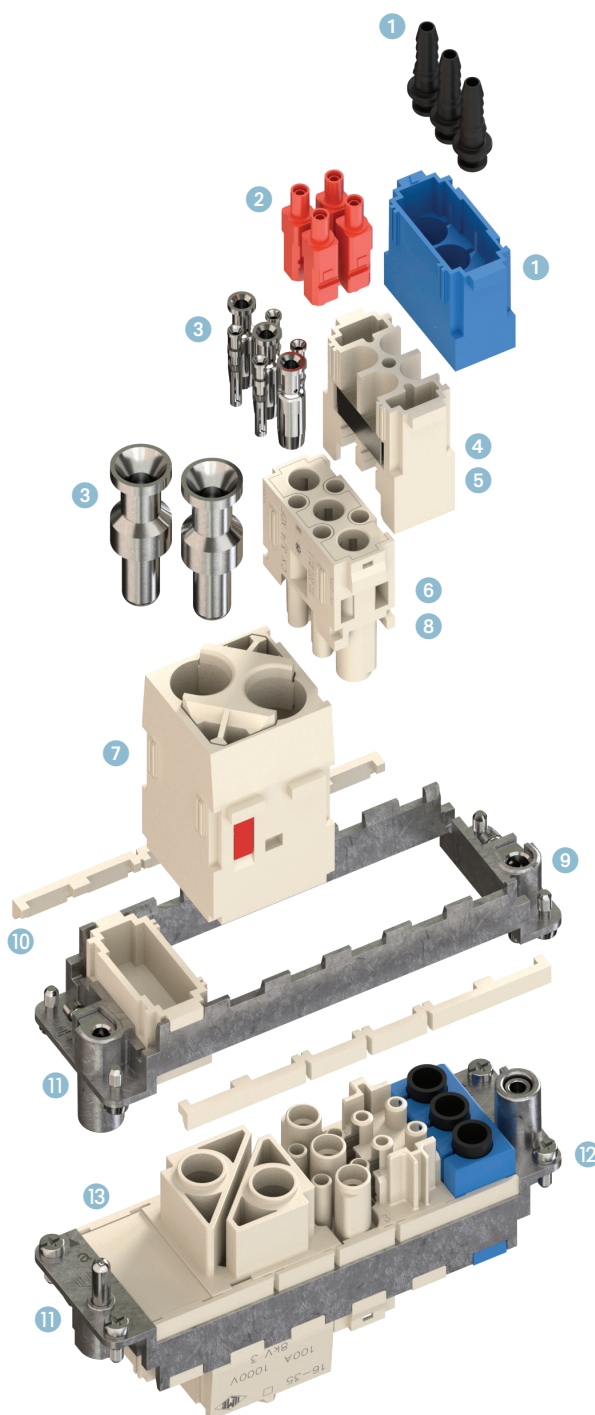

Watch  
our  
online  
tutorial



## MIXO SERIES ADVANTAGES

- Easy and user-friendly assembly of the complete multi-module insert before fixing it on the relevant sized metal frame;
- use of proprietary ILME technology providing each module with "swallowtail" lateral keys/keyways, for reciprocal locking of modules and overall assembly of the insert into rigid (non hinged) frames with snap-in locking strips;
- faster and easier assembly compared with competitor solutions (e.g. no need for additional, optional plastic stoppers to lock the hinge, no need for a hinged frame at all, easier handling of modules as a complete block than e.g. 6 independent parts);
- intermateability at "complete connector" (modules in frame) with other industry standard products;
- robust and long lasting prevailing crimp connection technology (largely preferred over screw type technology in high vibration and shock environments).

### MIXO SERIES AT A GLANCE

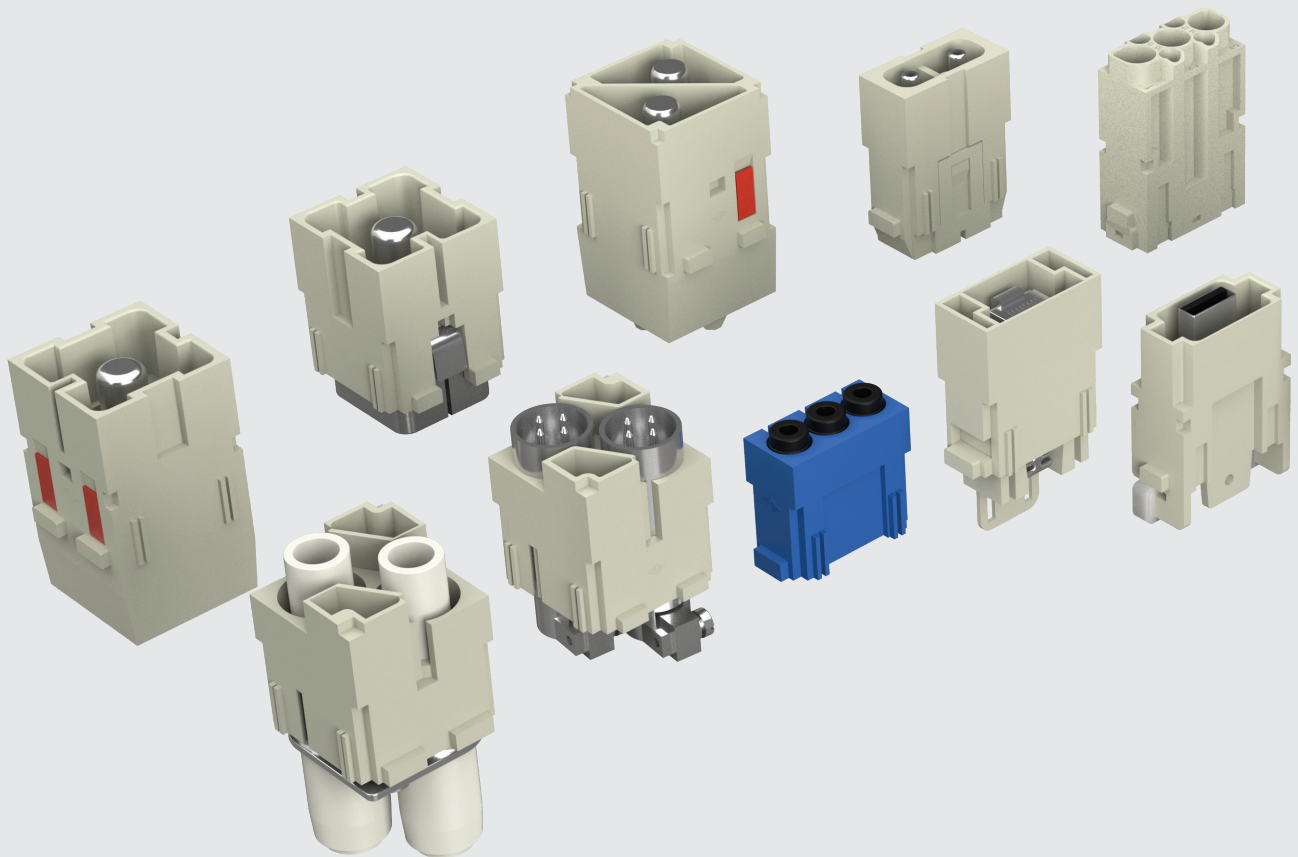





Find more information on our products at [www.ilme.com](http://www.ilme.com)

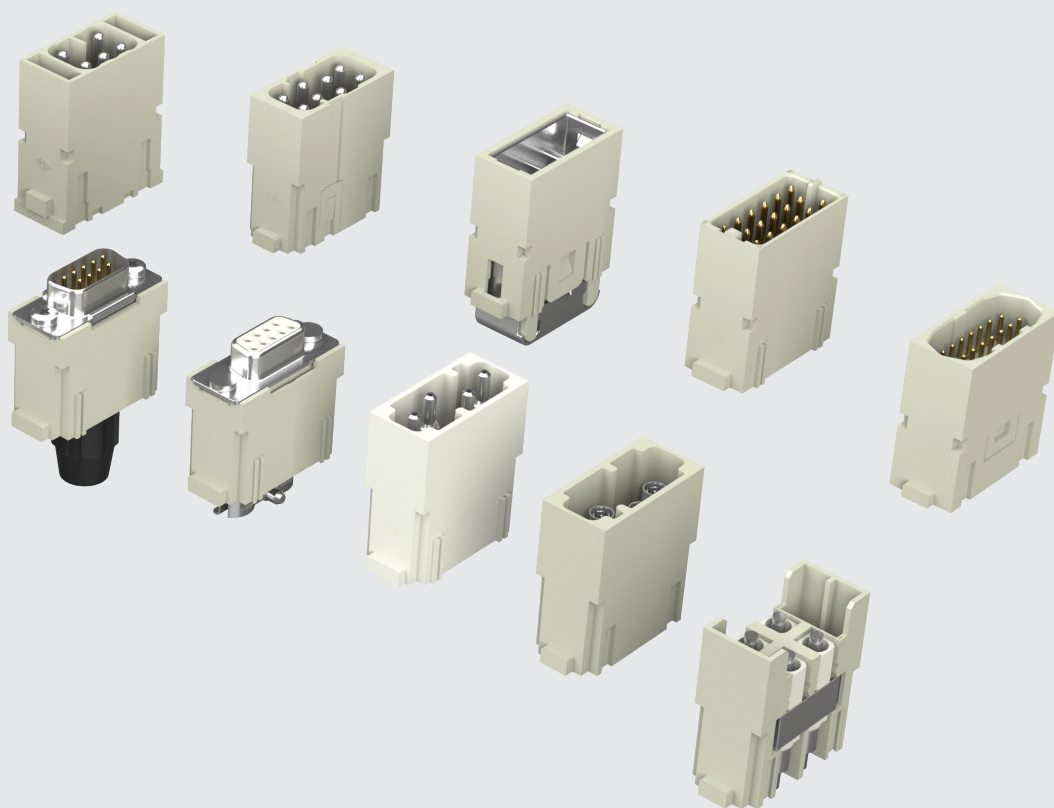

# CX 01 YF/YM 1 pole 200A - 1000V

The modular inserts must be installed in suitable frames, which are then mounted in traditional enclosures\* or in COB panel supports.

frames for modular units\*

page: 287

modular units, crimp connections

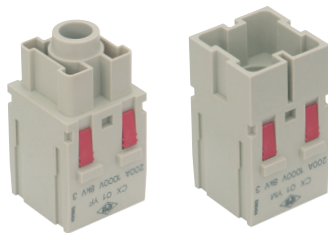

200A silver plated crimp contacts heat shrink tube

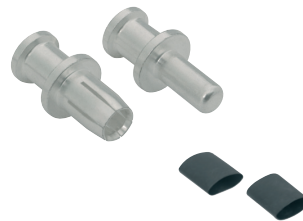

\* enclosures: housings or high construction hoods

description	part No.	part No.
-------------	----------	----------

without contacts (to be ordered separately)  
female inserts for female contacts  
male inserts for male contacts

CX 01 YF  
CX 01 YM

200A female crimp contacts

16 mm <sup>2</sup>	AWG 6	one groove (back side)
25 mm <sup>2</sup>	AWG 4	with no grooves
35 mm <sup>2</sup>	AWG 2	one groove
50 mm <sup>2</sup>	AWG 1	two grooves
70 mm <sup>2</sup>	AWG 2/0	with no grooves

CYFA 16  
CYFA 25  
CYFA 35  
CYFA 50  
CYFA 70

silver plated

200A male crimp contacts

16 mm <sup>2</sup>	AWG 6	one groove (back side)
25 mm <sup>2</sup>	AWG 4	with no grooves
35 mm <sup>2</sup>	AWG 2	one groove
50 mm <sup>2</sup>	AWG 1	two grooves
70 mm <sup>2</sup>	AWG 2/0	with no grooves

CYMA 16  
CYMA 25  
CYMA 35  
CYMA 50  
CYMA 70

heat shrink tube for CYFA/CYMA 16 contacts or for conductor with total external Ø < 10 mm

CR TT

- characteristics according to EN 61984:  
**200A 1000V 8kV 3**  
**200A 920/1600V 8kV 2**
- cULus (UL for USA and Canada), VDE, CEC, DNV-GL
- BUREAU VERITAS ERI certified
- rated voltage according to UL/CSA: 600V
- insulation resistance: ≥ 10 GΩ
- ambient temperature limit: -40 °C ... +125 °C
- made of self-extinguishing thermoplasticresin UL 94V-0
- mechanical life: ≥ 500 cycles
- contact resistance: ≤ 0,2 mΩ
- **it is recommended to crimp the contacts with crimping tools homologated by ILME** (please see the crimping tool section 200A contacts, CYF and CYM series) on pages 705 - 741
- for max. current load see the connector inserts derating diagram below; for more information see page 28

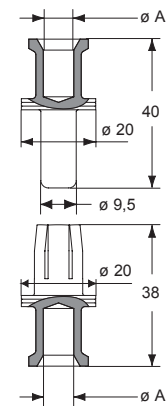
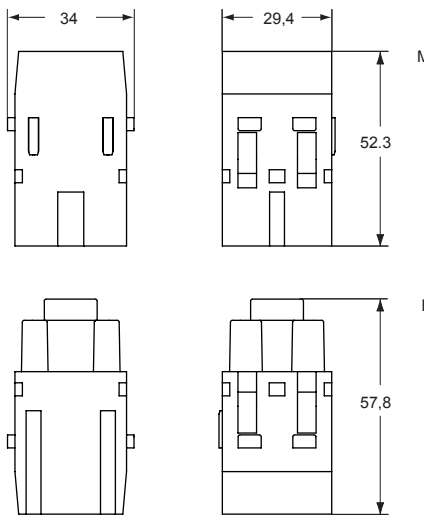

**CX 01 Y, 1 pole connector inserts (MIXO 200A)**  
Maximum current load derating diagram

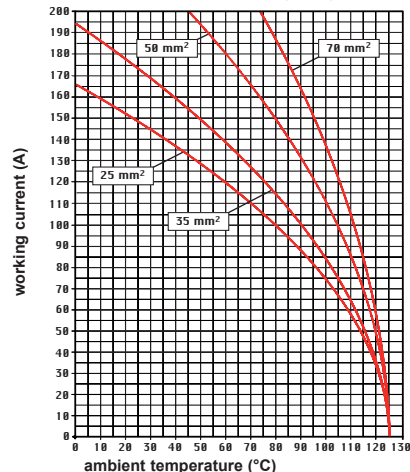

contacts side (front view)

side with reference arrow ▲

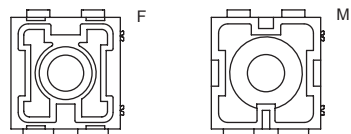

- 2 frame slots

**CYF and CYM contacts**

conductor section (mm <sup>2</sup> )	conductor slot (mm)	conductor stripping length (mm)
16	6,1	15
25	7,0	15
35	8,2	15
50	9,8	15
70	11,8	15

# CX 01 YPEF/YPEM 1 PE pole 200A

The modular inserts must be installed in suitable frames, which are then mounted in traditional enclosures\* or in COB panel supports.

frames for modular units\*

page:  
287

modular units, crimp connections  
PE module for earth termination

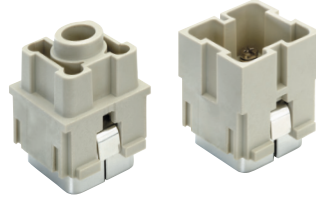

200A silver plated crimp contacts



\* enclosures: housings or high construction hoods

description	part No.	part No
-------------	----------	---------

without contacts (to be ordered separately)  
PE female inserts for female contacts  
PE male inserts for male contacts

**CX 01 YPEF**  
**CX 01 YPEM**

200A female crimp contacts

16 mm <sup>2</sup>	AWG 6	one groove (back side)
25 mm <sup>2</sup>	AWG 4	with no grooves
35 mm <sup>2</sup>	AWG 2	one groove
50 mm <sup>2</sup>	AWG 1	two grooves
70 mm <sup>2</sup>	AWG 2/0	with no grooves

**CYFA 16**  
**CYFA 25**  
**CYFA 35**  
**CYFA 50**  
**CYFA 70**

silver plated

200A male crimp contacts

16 mm <sup>2</sup>	AWG 6	one groove (back side)
25 mm <sup>2</sup>	AWG 4	with no grooves
35 mm <sup>2</sup>	AWG 2	one groove
50 mm <sup>2</sup>	AWG 1	two grooves
70 mm <sup>2</sup>	AWG 2/0	with no grooves

**CYMA 16**  
**CYMA 25**  
**CYMA 35**  
**CYMA 50**  
**CYMA 70**

- cULus (UL for USA and Canada), certified
- ambient temperature limit: -40 °C ... +125 °C
- made of self-extinguishing thermoplastic resin UL 94V-0
- **it is recommended to crimp the contacts with crimping tools homologated by ILME** (please see the crimping tool section 200A contacts, CYF and CYM series) on pages 705 - 741

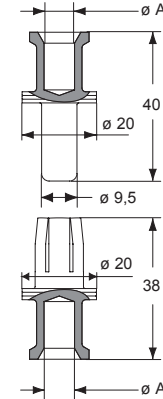
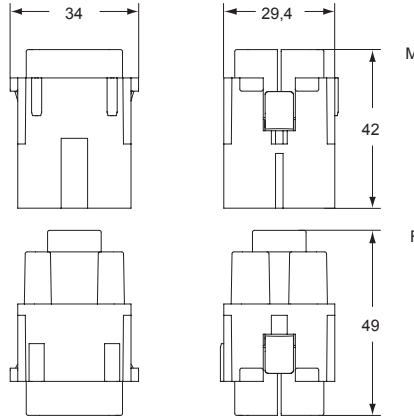

contacts side (front view)

side with reference arrow ▲

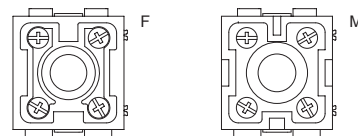

- 2 frame slots

**CYF and CYM contacts**

conductor section ø A (mm <sup>2</sup> )	conductor slot (mm)	conductor stripping length (mm)
16	6,1	15
25	7,0	15
35	8,2	15
50	9,8	15
70	11,8	15

# CX 01 GF/GM 1 pole 100A - 830V

The modular inserts must be installed in suitable frames which are then mounted in traditional enclosures\* or in COB panel support.  
Single-sized modular units may be directly mounted inside MIXO ONE enclosures.

frames for modular units\* page: 286 - 287

MIXO ONE enclosures 369

\* enclosures: bulkhead mounting housings, high construction housings or high construction hoods

modular units,  
crimp connections

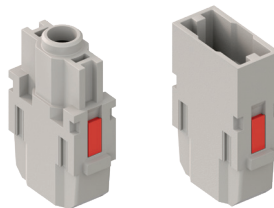

100A silver plated crimp contacts,  
PE adapter



description

part No.

part No.

without contacts (to be ordered separately)  
female inserts for female contacts  
male inserts for male contacts

CX 01 GF  
CX 01 GM

100A female crimp contacts  
8-10 mm<sup>2</sup> AWG 8-7  
16 mm<sup>2</sup> AWG 6-5  
25 mm<sup>2</sup> AWG 4-3  
35 mm<sup>2</sup> AWG 2

CGFA 10  
CGFA 16  
CGFA 25  
CGFA 35

silver plated

100A male crimp contacts  
8-10 mm<sup>2</sup> AWG 8-7  
16 mm<sup>2</sup> AWG 6-5  
25 mm<sup>2</sup> AWG 4-3  
35 mm<sup>2</sup> AWG 2

CGMA 10  
CGMA 16  
CGMA 25  
CGMA 35

cable earthing adapter 16 mm<sup>2</sup> (AWG 6-5)

CGT 16

- characteristics according to EN 61984:

**100A 830V 8kV 3**

- certified
- rated voltage according to UL/CSA: 600V
- insulation resistance:  $\geq 10 \text{ G}\Omega$
- ambient temperature limit:  $-40 \text{ }^\circ\text{C} \dots +125 \text{ }^\circ\text{C}$
- made of self-extinguishing thermoplastic resin UL 94V-0
- mechanical life:  $\geq 500$  cycles
- contact resistance:  $\leq 0,3 \text{ m}\Omega$
- **it is recommended to crimp the contacts with crimping tools homologated by ILME** (please see the crimping tool section 100A contacts, CGF and CGM series) on pages 705 - 741
- contact removal only using a screwdriver
- for max. current load see the connector inserts derating diagram below; for more information see page 28

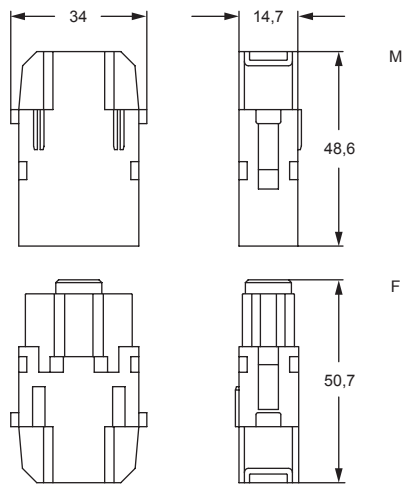

contacts side (front view)

side with reference arrow ▲

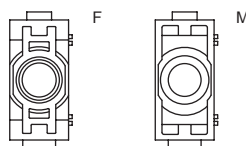

- 1 frame slot

CGF and CGM

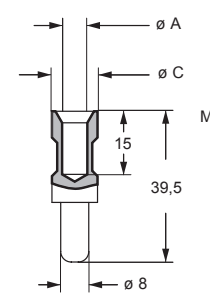

CGT 16

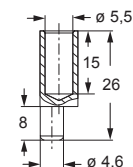

CGF and CGM contacts

conductor section (mm <sup>2</sup> )	conductor diameter (mm) ø A	conductor slot diameter (mm) ø B	conductor diameter (mm) ø C	conductor stripping length (mm)
8-10	4,3	4,3	13	15
16	5,5	5,5	13	15
25	7,0	7,0	13	15
35	7,9	8,2	12,5	15

How to use the PE adapter (CGT 16):

- 1) Strip 15 mm of flexible PE protective cable
- 2) Crimp the cable on the CGT 16 adapter by using the CGPZ pliers with the CGD 16 C matrix
- 3) Fix the adapter tip in the larger earth terminal (6 mm<sup>2</sup>) of frames CX...TM/TF
- 4) To be used with bulkhead mounting housings or high construction hoods
- 5) Cannot be used with T-TYPE series

CX 01 poles connector inserts  
Maximum current load derating diagram

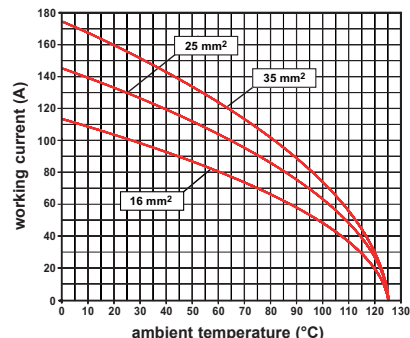

Watch our online tutorial

# CX 02 GF/GM 2 poles 100A - 1000V

The modular inserts must be installed in suitable frames, which are then mounted in traditional enclosures\* or in COB panel supports.

frames for modular units\*

page:  
287

modular units,  
crimp connections

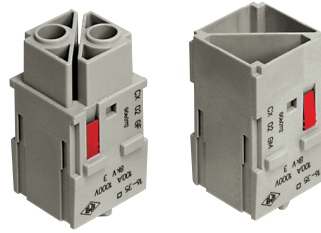

100A silver plated crimp contacts,  
PE adapter



\* enclosures: bulkhead mounting housings, high construction housings or high construction hoods

description	part No.	part No.
without contacts (to be ordered separately)		
female inserts for female contacts **	<b>CX 02 GF</b>	
male inserts for male contacts **	<b>CX 02 GM</b>	
100A female crimp contacts		<b>CGFA 10</b>
8-10 mm <sup>2</sup> AWG 8-7		<b>CGFA 16</b>
16 mm <sup>2</sup> AWG 6-5		<b>CGFA 25</b>
25 mm <sup>2</sup> AWG 4-3		<b>CGFA 35</b>
35 mm <sup>2</sup> AWG 2		
100A male crimp contacts		<b>CGMA 10</b>
8-10 mm <sup>2</sup> AWG 8-7		<b>CGMA 16</b>
16 mm <sup>2</sup> AWG 6-5		<b>CGMA 25</b>
25 mm <sup>2</sup> AWG 4-3		<b>CGMA 35</b>
35 mm <sup>2</sup> AWG 2		
cable earthing adapter 16 mm <sup>2</sup> (AWG 6-5)		<b>CGT 16</b>

silver plated

\*\* on request, version with pole 3/4 numbering.  
..references: **CX 02 GFN, CX 02 GMN**

- characteristics according to EN 61984:

**100A 1000V 8kV 3**  
**100A 920/1600V 8kV 2**

- cULus (UL for USA and Canada),

**ERC** certified

- rated voltage according to UL/CSA: 600V

- insulation resistance:  $\geq 10 \text{ G}\Omega$

- ambient temperature limit:  $-40 \text{ }^\circ\text{C} \dots +125 \text{ }^\circ\text{C}$

- made of self-extinguishing thermoplastic resin UL 94V-0

- mechanical life:  $\geq 500$  cycles

- contact resistance:  $\leq 0,3 \text{ m}\Omega$

- **it is recommended to crimp the contacts with crimping tools homologated by ILME** (please see the crimping tool section 100A contacts, CGF and CGM series) on pages 705 - 741

- for max. current load see the connector inserts derating diagram below; for more information see page 28

**CX 02 poles connector inserts**  
**Maximum current load derating diagram**

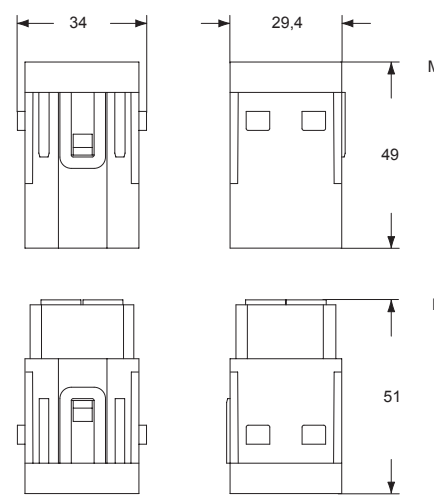
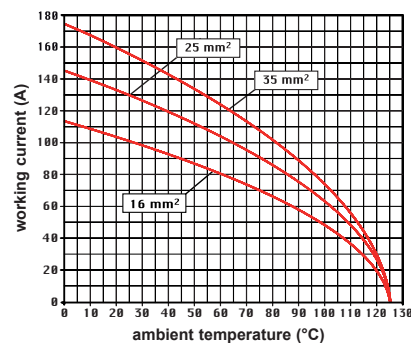

contacts side (front view)

side with reference arrow ▲

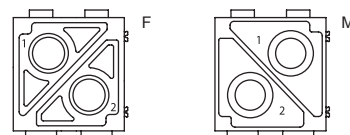

- 2 frame slots

**CGF and CGM**

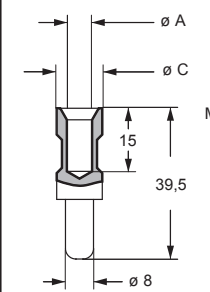

**CGT 16**

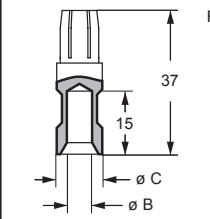
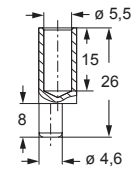

**CGF and CGM contacts**

conductor section (mm <sup>2</sup> )	conductor slot ø A (mm)	conductor slot ø B (mm)	conductor slot ø C (mm)	conductor stripping length (mm)
8-10	4,3	4,3	13	15
16	5,5	5,5	13	15
25	7,0	7,0	13	15
35	7,9	8,2	12,5	15

**How to use the PE adapter (CGT 16):**

- 1) Strip 15 mm of flexible PE protective cable
- 2) Crimp the cable on the CGT 16 adapter by using the CGPZ pliers with the CGD 16 C matrix
- 3) Fix the adapter tip in the larger earth terminal (6 mm<sup>2</sup>) of frames CX...TM/TF
- 4) To be used with bulkhead mounting housings or high construction hoods
- 5) Cannot be used with T-TYPE series

# CX 02 7F/7M 2 poles 70A - 1000V

The modular inserts must be installed in suitable frames which are then mounted in traditional enclosures\* or in COB panel support.  
Single-sized modular units may be directly mounted inside MIXO ONE enclosures.

frames for modular units\* page: 287  
MIXO ONE enclosures 369

\* enclosures: bulkhead mounting housings, high construction housings or high construction hoods

## modular units, crimp connections

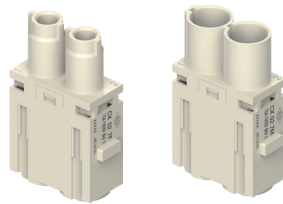

## 70A silver plated crimp contacts



description	part No.	part No
-------------	----------	---------

without contacts (to be ordered separately)  
female inserts for female contacts  
male inserts for male contacts

**CX 02 7F**  
**CX 02 7M**

70A female crimp contacts  
10 mm<sup>2</sup> AWG 8 - 7  
16 mm<sup>2</sup> AWG 6 - 5  
25 mm<sup>2</sup> AWG 4 - 3

**CX7FA 10**  
**CX7FA 16**  
**CX7FA 25**

70A male crimp contacts  
10 mm<sup>2</sup> AWG 8 - 7  
16 mm<sup>2</sup> AWG 6 - 5  
25 mm<sup>2</sup> AWG 4 - 3

**CX7MA 10**  
**CX7MA 16**  
**CX7MA 25**

silver plated

- characteristics according to EN 61984:

**70A 1000V 8kV 3**  
**70A 1600V 12kV 2**

- us (UL for USA and Canada),

certified

- insulation resistance:  $\geq 10 \text{ G}\Omega$
- ambient temperature limit:  $-40 \text{ }^\circ\text{C} \dots +125 \text{ }^\circ\text{C}$
- made of self-extinguishing thermoplastic resin UL 94V-0
- mechanical life:  $\geq 500$  cycles
- **it is recommended to crimp the contacts with crimping tools homologated by ILME** (please see the crimping tool section 70A contacts, CX7F and CX7M series) on pages 705 - 741
- **C7ES** removal tool
- for max. current load see the connector inserts derating diagram below; for more information see page 28

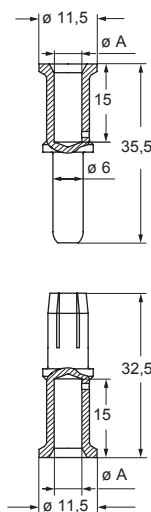
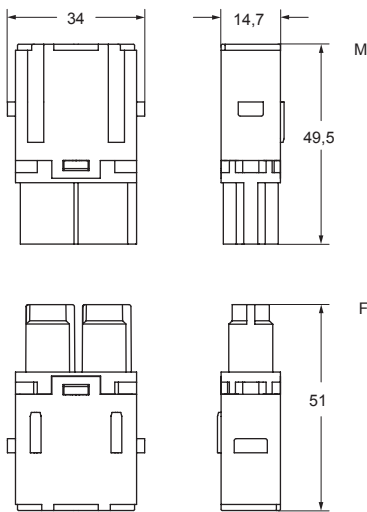

**CX 02 7, 2 poles connector inserts**  
**Maximum current load derating diagram**

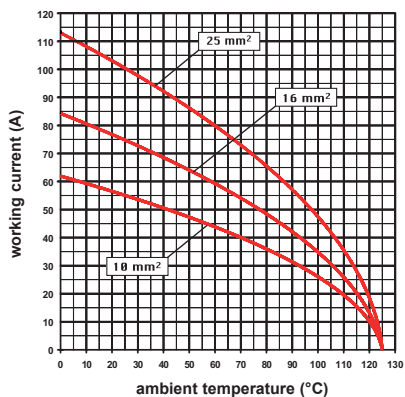

contacts side (front view)

side with reference arrow ▲

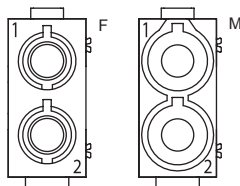

- 1 frame slot

### CX7F and CX7M contacts

conductor section (mm <sup>2</sup> )	conductor slot ø A (mm)	conductor stripping length (mm)
10	4,3	15
16	5,5	15
25	7,0	15



# CX 02 4F/4M 2 poles 40A - 1000V

The modular inserts must be installed in suitable frames which are then mounted in traditional enclosures\* or in COB panel support.  
Single-sized modular units may be directly mounted inside MIXO ONE enclosures.

frames for modular units\* page: 286 - 287  
MIXO ONE enclosures 369

\* enclosures: bulkhead mounting housings, high construction housings or high construction hoods

## modular units, crimp connections

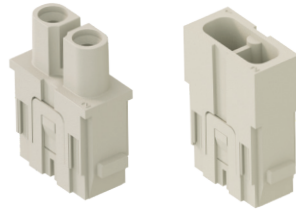

## 40A silver plated crimp contacts



description	part No.	part No.
-------------	----------	----------

without contacts (to be ordered separately)  
female inserts for female contacts \*  
male inserts for male contacts \*

CX 02 4F  
CX 02 4M

40A female crimp contacts  
1,5 mm<sup>2</sup> AWG 16  
2,5 mm<sup>2</sup> AWG 14  
4 mm<sup>2</sup> AWG 12  
6 mm<sup>2</sup> AWG 10  
10 mm<sup>2</sup> AWG 8

CXFA 1.5  
CXFA 2.5  
CXFA 4.0  
CXFA 6.0  
CXFA 10

silver plated

40A male crimp contacts  
1,5 mm<sup>2</sup> AWG 16  
2,5 mm<sup>2</sup> AWG 14  
4 mm<sup>2</sup> AWG 12  
6 mm<sup>2</sup> AWG 10  
10 mm<sup>2</sup> AWG 8

CXMA 1.5  
CXMA 2.5  
CXMA 4.0  
CXMA 6.0  
CXMA 10

\* cable diameter up to 7,5 mm  
contact size up to 10 mm<sup>2</sup>

- characteristics according to EN 61984:  
**40A 1000V 8kV 3**



- insulation resistance: ≥ 10 GΩ  
- ambient temperature limit: -40 °C ... +125 °C  
- made of self-extinguishing thermoplastic resin UL 94V-0

- mechanical life: ≥ 500 cycles  
- contact resistance: ≤ 0,3 mΩ

- can be mated with CX 02 A/B modules

- **it is recommended to crimp the contacts** (1,5 - 10 mm<sup>2</sup>), with crimping tools homologated by **ILME** (please see the crimping tool section 40A contacts, CXF and CXM series) on pages 705 - 741

- for max. current load see the connector insert derating diagram below; for more information see page 28

**CX 02 4, 2 poles connector inserts**  
Maximum current load derating diagram

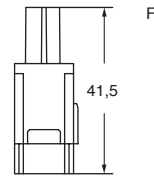
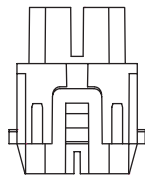
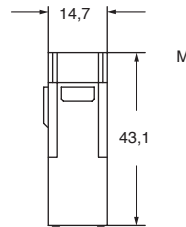
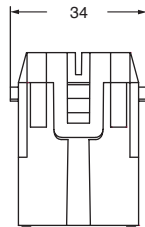
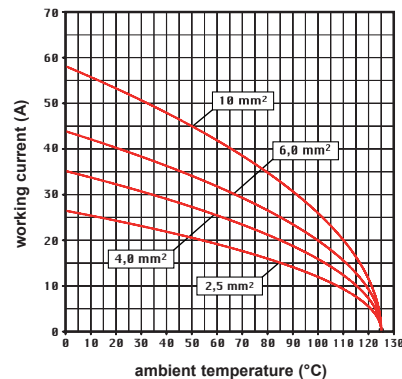

contacts side (front view)

side with reference arrow ▲

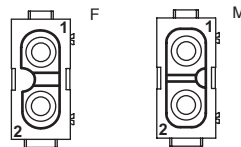

- 1 frame slot

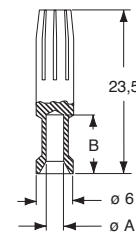
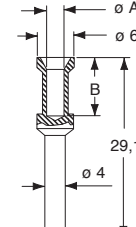

**CXF and CXM contacts**

conductor section (mm <sup>2</sup> )	conductor slot ø A (mm)	conductor stripping length B (mm)
1,5	1,8	9
2,5	2,2	9
4	2,85	9,6
6	3,5	9,6
10	4,3	15

# CX 02 4AF/4AM - CX 02 4BF/4BM 2 poles 40A - 1000V

The modular inserts must be installed in suitable frames which are then mounted in traditional enclosures or in COB panel support.  
Single-sized modular units may be directly mounted inside MIXO ONE enclosures.

frames for modular units page: 286 - 287  
MIXO ONE enclosures 369

modular units,  
screw terminal connection  
2,5 - 8 mm<sup>2</sup>

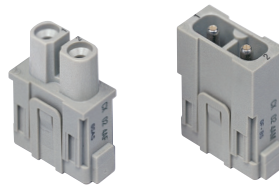

modular units,  
screw terminal connection  
6 - 10 mm<sup>2</sup>

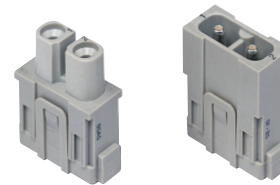

description

part No.

part No.

female inserts with female contacts  
male inserts with male contacts

**CX 02 4AF**  
**CX 02 4AM**

female inserts with female contacts  
male inserts with male contacts

**CX 02 4BF**  
**CX 02 4BM**

- use flexible cables with sections from 2,5 to 10 mm<sup>2</sup> or extra flexible cables with sections from 2,5 to 6 mm<sup>2</sup>
- do not twist the cables
- fully insert the braids in the rear section of the contact

conductor section (mm <sup>2</sup> )	conductor stripping length (mm)	tightening torque (Nm)
2,5	5+1	1,5
4	5+1	1,5
6	8+1	2
10	8+1	2

- insert a 2 mm hexagonal key in the front section of the contact and tighten by keeping the cable held down in position
- a 2 mm hexagonal key can be supplied on request, reference **CX AS**



- characteristics according to EN 61984:

**40A 1000V 8kV 3**  
**40A 1600V 12kV 2**

- certified
- rated voltage according to UL/CSA: 600V
- insulation resistance: ≥ 10 GΩ
- ambient temperature limit: -40 °C ... +125 °C
- made of self-extinguishing thermoplastic resin UL 94V-0
- mechanical life: ≥ 500 cycles
- contact resistance: ≤ 0,5 mΩ
- for max. current load see the connector inserts derating diagram below; for more information see page 28

**CX 02 4A/B, 2 poles connector inserts**  
**Maximum current load derating diagram**

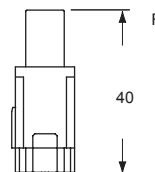
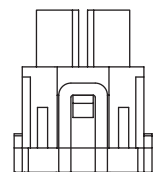
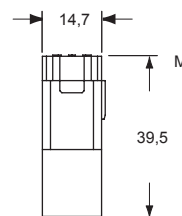
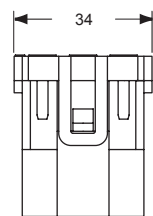
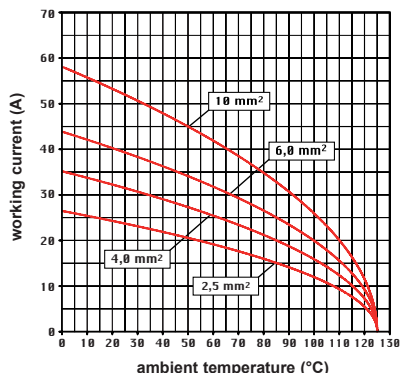

contacts side (front view)

side with reference arrow ▲

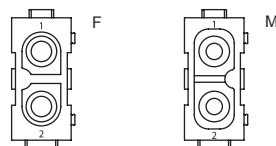

- inserts for Ø 4mm cables, section: 2,5-8 mm<sup>2</sup> - AWG 14-8
- 1 frame slot

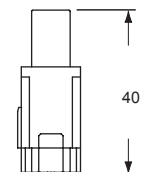
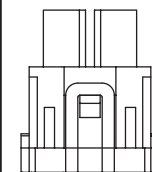
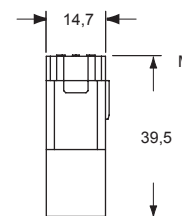
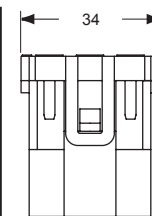

contacts side (front view)

side with reference arrow ▲

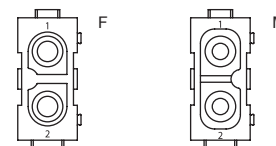

- inserts for Ø 4,8 mm cables, section: 6-10 mm<sup>2</sup> - AWG 10-8
- 1 frame slot

# CX 03 4F/4M 3 poles 40A - 400/690V

The modular inserts must be installed in suitable frames which are then mounted in traditional enclosures or in COB panel support.  
Single-sized modular units may be directly mounted inside MIXO ONE enclosures.

frames for modular units page: 286 - 287  
MIXO ONE enclosures 369

modular units, crimp connections

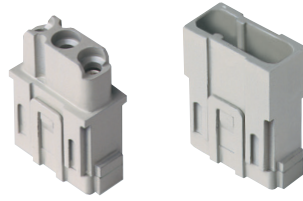

40A silver plated crimp contacts



description	part No.	part No.
without contacts (to be ordered separately)		
female inserts for female contacts *	<b>CX 03 4F</b>	
male inserts for male contacts *	<b>CX 03 4M</b>	
40A female crimp contacts		
1,5 mm <sup>2</sup> AWG 16		<b>CXFA 1.5</b>
2,5 mm <sup>2</sup> AWG 14		<b>CXFA 2.5</b>
4 mm <sup>2</sup> AWG 12		<b>CXFA 4.0</b>
6 mm <sup>2</sup> AWG 10		<b>CXFA 6.0</b>
40A male crimp contacts		
1,5 mm <sup>2</sup> AWG 16		<b>CXMA 1.5</b>
2,5 mm <sup>2</sup> AWG 14		<b>CXMA 2.5</b>
4 mm <sup>2</sup> AWG 12		<b>CXMA 4.0</b>
6 mm <sup>2</sup> AWG 10		<b>CXMA 6.0</b>

silver plated

\* cable diameter up to 5 mm

- characteristics according to EN 61984:
- 40A 400/690V 6kV 3**
- certified
- rated voltage according to UL/CSA: 600V
- insulation resistance: ≥ 10 GΩ
- ambient temperature limit: -40 °C ... +125 °C
- made of self-extinguishing thermoplastic resin UL 94V-0
- mechanical life: ≥ 500 cycles
- contact resistance: ≤ 0,3 mΩ
- **it is recommended to crimp the contacts with crimping tools homologated by ILME** (please see the crimping tool section 40A contacts, CXF and CXM series) on pages 705 - 741
- for max. current load see the connector inserts derating diagram below; for more information see page 28

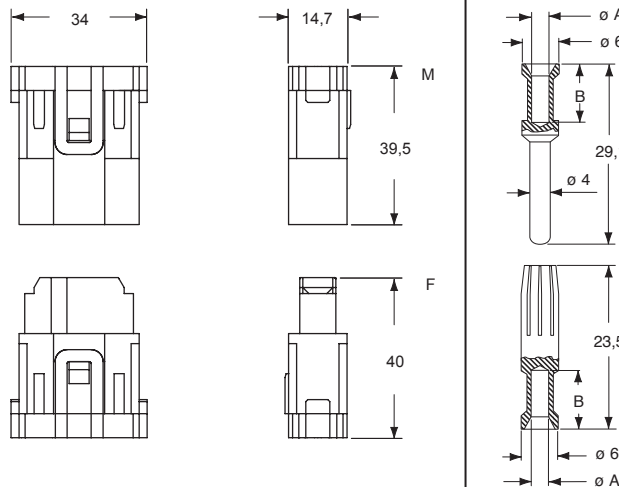

contacts side (front view)

side with reference arrow ▲

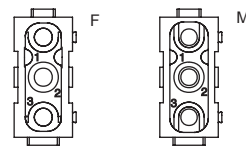

- 1 frame slot

**CXF and CXM contacts**

conductor section (mm <sup>2</sup> )	conductor slot ø A (mm)	conductor stripping length B (mm)
1,5	1,8	9
2,5	2,2	9
4	2,85	9,6
6	3,5	9,6

**CX 03 poles connector inserts**  
Maximum current load derating diagram

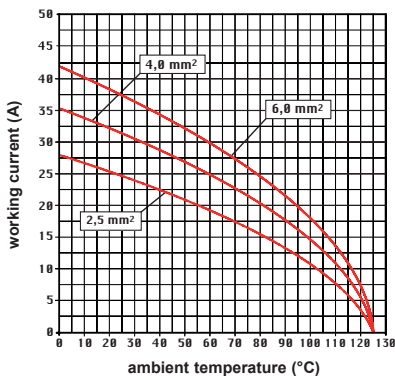

# CX 03 4BF/4BM 3 poles 40A - 500V

The modular inserts must be installed in suitable frames which are then mounted in traditional enclosures\* or in COB panel support.  
Single-sized modular units may be directly mounted inside MIXO ONE enclosures.

frames for modular units\* page: 286 - 287

MIXO ONE enclosures 369

\* enclosures: bulkhead mounting housings, high construction housings or high construction hoods

## modular units, crimp connections

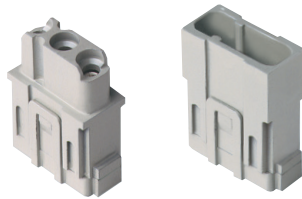

## 40A silver plated crimp contacts



description

part No.

part No.

without contacts (to be ordered separately)  
female inserts for female contacts \*  
male inserts for male contacts \*

CX 03 4BF  
CX 03 4BM

40A female crimp contacts

1,5 mm <sup>2</sup>	AWG 16
2,5 mm <sup>2</sup>	AWG 14
4 mm <sup>2</sup>	AWG 12
6 mm <sup>2</sup>	AWG 10
10 mm <sup>2</sup>	AWG 8

40A male crimp contacts

1,5 mm <sup>2</sup>	AWG 16
2,5 mm <sup>2</sup>	AWG 14
4 mm <sup>2</sup>	AWG 12
6 mm <sup>2</sup>	AWG 10
10 mm <sup>2</sup>	AWG 8

CXFA 1.5  
CXFA 2.5  
CXFA 4.0  
CXFA 6.0  
CXFA 10

silver plated

CXMA 1.5  
CXMA 2.5  
CXMA 4.0  
CXMA 6.0  
CXMA 10

\* cable diameter up to 7,5 mm  
contact size up to 10 mm<sup>2</sup>

- characteristics according to EN 61984:

**40A 500V 6kV 3**

- cULus (UL for USA and Canada),

certified

- insulation resistance:  $\geq 10 \text{ G}\Omega$

- ambient temperature limit:  $-40 \text{ }^\circ\text{C} \dots +125 \text{ }^\circ\text{C}$

- made of self-extinguishing thermoplastic resin  
UL 94V-0

- mechanical life:  $\geq 500$  cycles

- contact resistance:  $\leq 0,3 \text{ m}\Omega$

- can be mated with CX 02 A/B modules

- **it is recommended to crimp the contacts**  
(1,5 - 10 mm<sup>2</sup>), **with crimping tools homologated**  
**by ILME** (please see the crimping tool section 40A  
contacts, CXF and CXM series) on pages 705 - 741

- for max. current load see the connector inserts derating  
diagram below; for more information see page 28

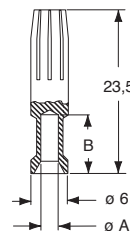
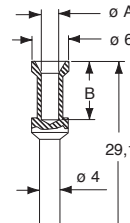
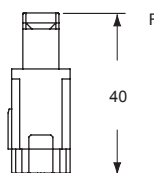
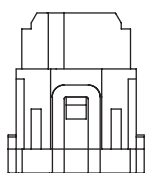
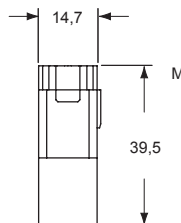
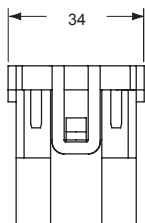

contacts side (front view)

side with reference arrow ▲

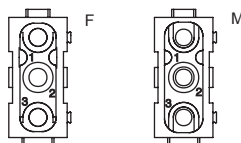

- 1 frame slot

**CX 03 4B, 3 poles connector inserts**  
**Maximum current load derating diagram**

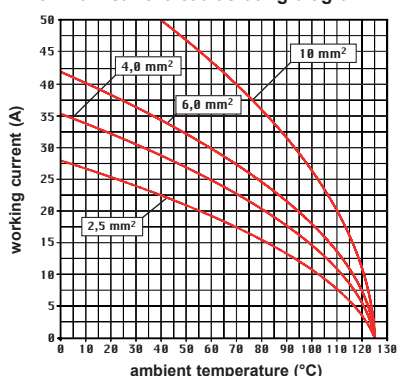

**CXF and CXM contacts**

conductor section (mm <sup>2</sup> )	conductor slot $\phi A$ (mm)	conductor stripping length B (mm)
1,5	1,8	9
2,5	2,2	9
4	2,85	9,6
6	3,5	9,6
10	4,3	15

# CX 3/4 XDF/XDM 3 poles (40A - 830V) + 4 poles (10A - 830V)

The modular inserts must be installed in suitable frames which are then mounted in traditional enclosures or in COB panel support. Single-sized modular units may be directly mounted inside MIXO ONE enclosures.

page:

frames for modular units 286 - 287  
MIXO ONE enclosures 369

- male and female contacts finger proof
- their key characteristic lies in the fact that they guarantee maximum safety even in case of accidental contact with fingers (IP2X or IPXXB). Safety is guaranteed as standard on female contacts, but also on male contacts. This feature is important as it ensures full compliance with the recent safety standard EN 60204-1, concerning electric equipment fitted on machines and in particular with the requirements of Article 6.2.4 concerning protection against residual voltage. In the case of plugs or similar devices, the with drawal of which results in the exposure of conductors (for example pins), the discharge time shall not exceed 1 s, otherwise such conductors shall be protected against direct contact to at least an IP2X or IPXXB.

## modular units, crimp connections

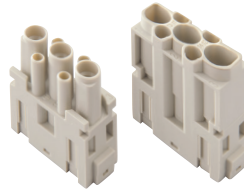

## 40A and 10A crimp contacts silver and gold plated



description	part No.	part No.
without contacts (to be ordered separately)		
female inserts for female contacts	<b>CX 3/4 XDF</b>	
male inserts for male contacts	<b>CX 3/4 XDM</b>	
<b>40A female crimp contacts</b>		<b>CXFA 1.5</b>
1,5 mm <sup>2</sup> AWG 16		<b>CXFA 2.5</b>
2,5 mm <sup>2</sup> AWG 14		<b>CXFA 4.0</b>
4 mm <sup>2</sup> AWG 12		<b>CXFA 6.0</b>
6 mm <sup>2</sup> AWG 10		
<b>40A male crimp contacts</b>		<b>CXMA 1.5</b>
1,5 mm <sup>2</sup> AWG 16		<b>CXMA 2.5</b>
2,5 mm <sup>2</sup> AWG 14		<b>CXMA 4.0</b>
4 mm <sup>2</sup> AWG 12		<b>CXMA 6.0</b>
6 mm <sup>2</sup> AWG 10		
<b>10A female crimp contacts</b>		<b>CDFA 0.3</b>
0,14-0,37 mm <sup>2</sup> AWG 26-22 identification No. 1		<b>CDFA 0.5</b>
0,5 mm <sup>2</sup> AWG 20 identification No. 2		<b>CDFA 0.7</b>
0,75 mm <sup>2</sup> AWG 18 identification No. ②		<b>CDFA 1.0</b>
1 mm <sup>2</sup> AWG 18 identification No. 3		<b>CDFA 1.5</b>
1,5 mm <sup>2</sup> AWG 16 identification No. 4		<b>CDFA 2.5</b>
2,5 mm <sup>2</sup> AWG 14 identification No. 5		
<b>10A male crimp contacts</b>		<b>CDMA 0.3</b>
0,14-0,37 mm <sup>2</sup> AWG 26-22 identification No. 1		<b>CDMA 0.5</b>
0,5 mm <sup>2</sup> AWG 20 identification No. 2		<b>CDMA 0.7</b>
0,75 mm <sup>2</sup> AWG 18 identification No. ②		<b>CDMA 1.0</b>
1 mm <sup>2</sup> AWG 18 identification No. 3		<b>CDMA 1.5</b>
1,5 mm <sup>2</sup> AWG 16 identification No. 4		<b>CDMA 2.5</b>
2,5 mm <sup>2</sup> AWG 14 identification No. 5		

silver plated

+ for basic or high thickness gold plating, please refer to page 674

gold plated+

- characteristics according to EN 61984:
- 3 poles 40A 830V 8kV 3**
- 4 poles 10A 830V 8kV 3**
- cULus (UL for USA and Canada),
- certified
- rated voltage according to UL/CSA: 600V
- insulation resistance: ≥ 10 GΩ
- ambient temperature limit: -40 °C ... +125 °C
- made of self-extinguishing thermoplastic resin UL 94V-0
- mechanical life: ≥ 500 cycles
- contact resistance: ≤ 0,3 mΩ (3 poles), ≤ 3 mΩ (4 poles)
- for max. current load see the connector inserts derating diagram below; for more information see page 28

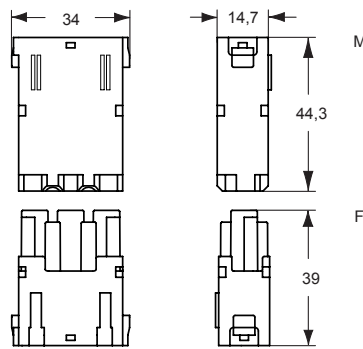

contacts side (front view)

side with reference arrow ▲

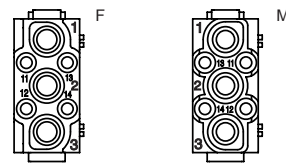

- 1 frame slot

- it is recommended to crimp the contacts with crimping tools homologated by ILME (please see the crimping tool section 40A contacts, CXF, CXM series and 10A contacts CDF, CDM series) on pages 705 - 741

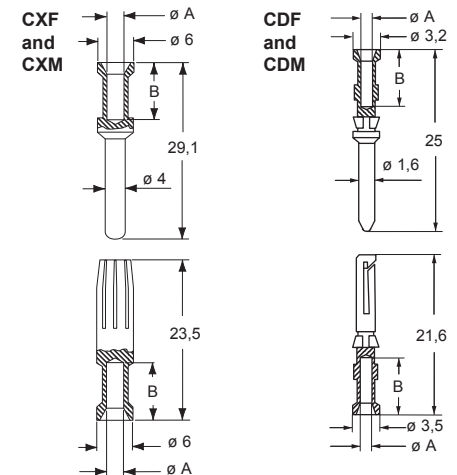

### CXF and CXM contacts

conductor section (mm <sup>2</sup> )	conductor slot ø A (mm)	conductors stripping length B (mm)
1,5	1,8	9
2,5	2,2	9
4	2,85	9,6
6	3,5	9,6

### CDF and CDM contacts

conductor section (mm <sup>2</sup> )	conductor slot ø A (mm)	conductors stripping length B (mm)
0,14-0,37	0,9	8
0,5	1,1	8
0,75	1,3	8
1,0	1,45	8
1,5	1,8	8
2,5	2,2	6

### CX 3/4 poles connector inserts Maximum current load derating diagram

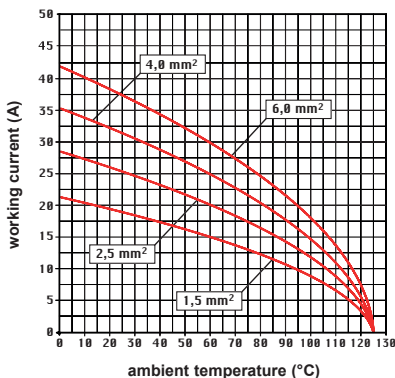

# CX 04 XF/XM 4 poles 40A - 830V

The modular inserts must be installed in suitable frames which are then mounted in traditional enclosures\* or in COB panel support.  
Single-sized modular units may be directly mounted inside MIXO ONE enclosures.

frames for modular units\* page: 286 - 287

MIXO ONE enclosures 369

\* enclosures: bulkhead mounting housings, high construction housings or high construction hoods

modular units, crimp connections with red lock-in tabs (included)

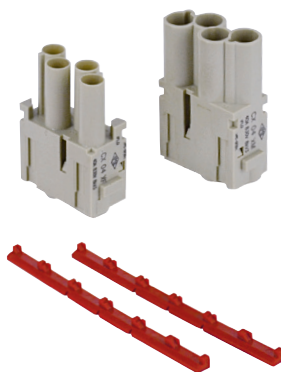

40A silver plated crimp contacts



description

part No.

part No

without contacts (to be ordered separately)  
(module red lock-in tabs included)  
female inserts for female contacts  
male inserts for male contacts

CX 04 XF  
CX 04 XM

40A female crimp contacts  
1,5 mm<sup>2</sup> AWG 16  
2,5 mm<sup>2</sup> AWG 14  
4 mm<sup>2</sup> AWG 12  
6 mm<sup>2</sup> AWG 10

CXFA 1.5  
CXFA 2.5  
CXFA 4.0  
CXFA 6.0

40A male crimp contacts  
1,5 mm<sup>2</sup> AWG 16  
2,5 mm<sup>2</sup> AWG 14  
4 mm<sup>2</sup> AWG 12  
6 mm<sup>2</sup> AWG 10

CXMA 1.5  
CXMA 2.5  
CXMA 4.0  
CXMA 6.0

silver plated

- characteristics according to EN 61984:

**40A 830V 8kV 3**  
**40A 1000V 8kV 2**

- cULus (UL for USA and Canada), VDE, CQC, DNV-GL

- BUREAU VERITAS EAC certified

- rated voltage according to UL/CSA: 600V

- insulation resistance:  $\geq 10 \text{ G}\Omega$

- ambient temperature limit: -40 °C ... +125 °C

- made of self-extinguishing thermoplastic resin UL 94V-0

- mechanical life:  $\geq 500$  cycles

- contact resistance:  $\leq 0,3 \text{ m}\Omega$

- **it is recommended to crimp the contacts with crimping tools homologated by ILME** (please see the crimping tool section 40A contacts, CXF and CXM series) on pages 705 - 741

- for max. current load see the connector inserts derating diagram below; for more information see page 28

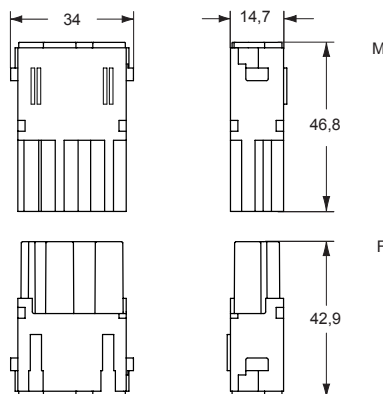

contacts side (front view)  
side with reference arrow ▲

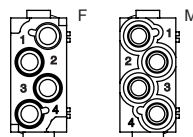

- 1 frame slot

Female inserts are supplied with two red lock tabs that must be used instead of those supplied with the frames.

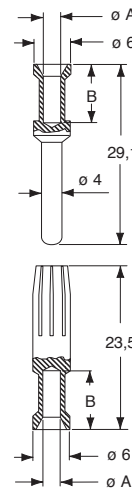
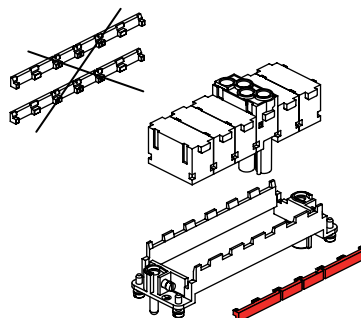

**CXF and CXM contacts**

conductor section (mm <sup>2</sup> )	conductor slot $\varnothing A$ (mm)	conductor stripping length B (mm)
1,5	1,8	9
2,5	2,2	9
4	2,85	9,6
6	3,5	9,6

- male and female contacts finger proof  
- their key characteristic lies in the fact that they guarantee maximum safety even in case of accidental contact with fingers (IP2X or IPXXB). Safety is guaranteed as standard on female contacts, but also on male contacts. This feature is important as it ensures full compliance with the recent safety standard EN 60204-1, concerning electric equipment fitted on machines and in particular with the requirements of Article 6.2.4 concerning protection against residual voltage. **In the case of plugs or similar devices, the with drawal of which results in the exposure of conductors (for example pins), the discharge time shall not exceed 1 s, otherwise such conductors shall be protected against direct contact to at least an IP2X or IPXXB.**

**CX 04 poles connector inserts**  
**Maximum current load derating diagram**

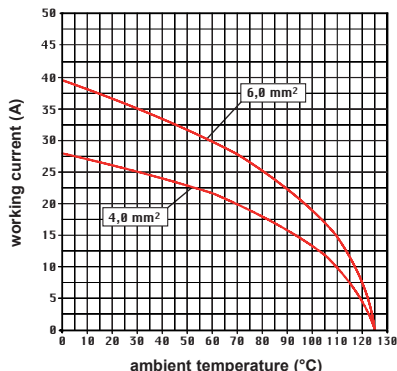

MIXO



# CX 05 SF/SM 5 poles 16A - 400V

The modular inserts must be installed in suitable frames which are then mounted in traditional enclosures or in COB panel support.  
Single-sized modular units may be directly mounted inside MIXO ONE enclosures.

frames for modular units	page: 286 - 287
MIXO ONE enclosures	369

## modular units, spring connection

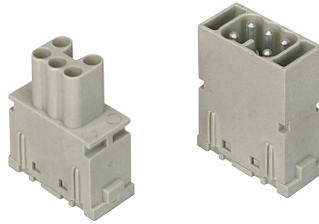

description	part No.
female inserts with female contacts	<b>CX 05 SF</b>
male inserts with male contacts	<b>CX 05 SM</b>

- characteristics according to EN 61984:  
**16A 400V 6kV 3**  
**16A 500V 6kV 2**
- certified
- rated voltage according to UL/CSA: 600V
- insulation resistance:  $\geq 10 \text{ G}\Omega$
- ambient temperature limit:  $-40 \text{ }^\circ\text{C} \dots +125 \text{ }^\circ\text{C}$
- made of self-extinguishing thermoplastic resin UL 94V-0
- mechanical life:  $\geq 500$  cycles
- contact resistance:  $\leq 3 \text{ m}\Omega$
- for max. current load see the connector inserts derating diagram below; for more information see page 28

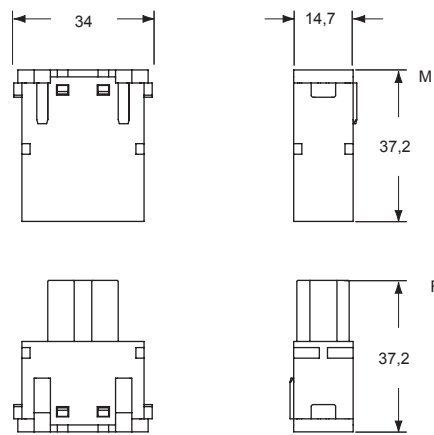

contacts side (front view)

side with reference arrow ▲

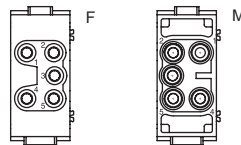

- inserts for section conductors: 0,14 - 2,5 mm<sup>2</sup> - AWG 26 - 14
- conductors stripping length: 9...11 mm
- 1 frame slot

**CX 05 poles connector inserts**  
**Maximum current load derating diagram**

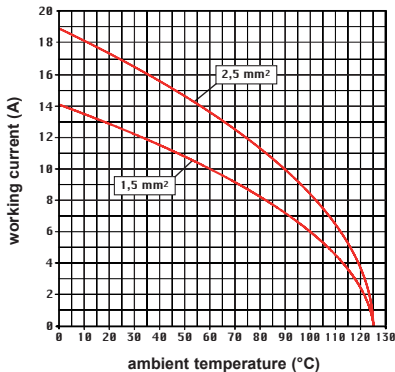

## Connection technology with spring terminal

**step 1**  
When the screwdriver is inserted in the square housing provided, the wire housing in the spring is opened

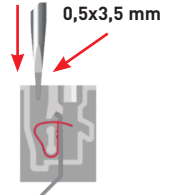

**step 2**  
The wire is pushed all the way in the round housing provided

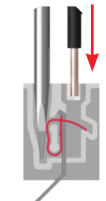

**step 3**  
When the screwdriver is removed, the spring is held down on the inserted wire

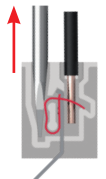

**step 4**  
The connection is complete; pull on the wire to make sure that the spring firmly holds down the wire

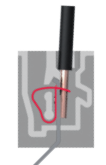

The modular inserts must be installed in suitable frames which are then mounted in traditional enclosures or in COB panel support.  
Single-sized modular units may be directly mounted inside MIXO ONE enclosures.

frames for modular units	page: 286
MIXO ONE enclosures	369

Suitable for every conductor type (prepared with ferrule, unprepared and solid) up to cross-sectional area 2,5 mm<sup>2</sup>

modular units,  
SQUICH®-spring terminal connection

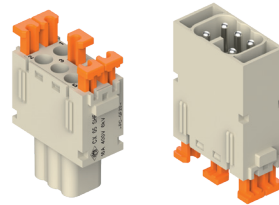

**AVAILABLE JULY 2019**

description	part No.
-------------	----------

spring terminals with actuator button  
female inserts with female contacts  
male inserts with male contacts

**CX 05 SHF**  
**CX 05 SHM**

- characteristics according to EN 61984:
- 16A 400V 6kV 3**
- cURus, CSA, CQC, DNV-GL, BV, EAC pending
- rated voltage according to UL/CSA: 600V
- insulation resistance: ≥ 10 GΩ
- ambient temperature limit: -40 °C ... +125 °C
- made of self-extinguishing thermoplastic resin UL 94V-0
- mechanical life: ≥ 500 cycles
- contact resistance: ≤ 3 mΩ
- for max. current load see the connector inserts derating diagram below; for more information see page 28

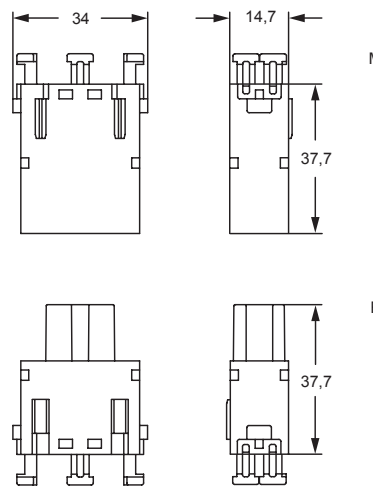

contacts side (front view)

rear view, side with reference arrow ▲

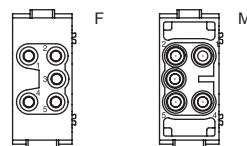

- 1 frame slot

- inserts for cables with the following cross-sectional area: 0,14 - 2,5 mm<sup>2</sup> - AWG 26 - 14
- conductors stripping length: 9...11 mm

**CX 05 SHF/SHM power poles connector inserts**  
**Maximum current load derating diagram**

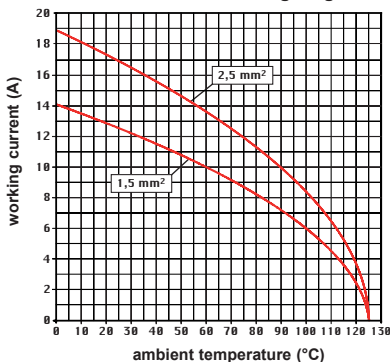

**MIXO CX 05 SHF/M**  
**SQUICH®-spring connection technology**

**WIRING**

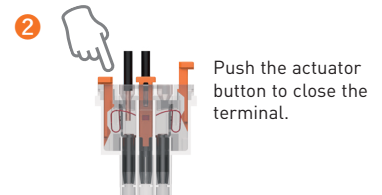
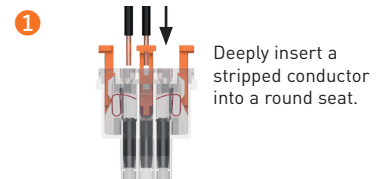

**RE-OPENING**

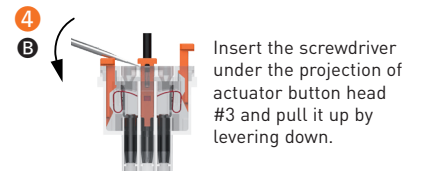
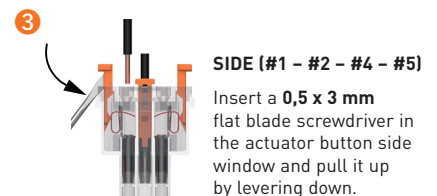

MIXO

# CX 06 CF/CM 6 poles 16A - 500V

The modular inserts must be installed in suitable frames which are then mounted in traditional enclosures or in COB panel support.  
Single-sized modular units may be directly mounted inside MIXO ONE enclosures.

frames for modular units	page: 286 - 287
MIXO ONE enclosures	369

- it is recommended to crimp the contacts with crimping tools homologated by ILME (please see the crimping tool section 16A contacts, CCF, CCM and CC...AN series) on pages 705 - 741

## modular units, crimp connections

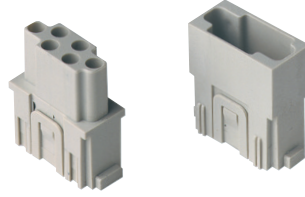

## 16A crimp contacts standard or for advanced opening silver and gold plated

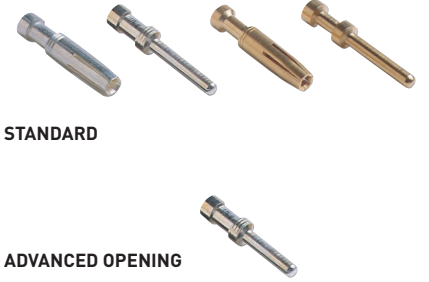

STANDARD

ADVANCED OPENING

description	part No.	part No.
without contacts (to be ordered separately)		
female inserts for female contacts	<b>CX 06 CF</b>	
male inserts for male contacts	<b>CX 06 CM</b>	
16A female crimp contacts		
0,14-0,37 mm <sup>2</sup> AWG 26-22 one groove	<b>CCFA 0.3</b>	<b>CCFD 0.3</b>
0,5 mm <sup>2</sup> AWG 20 with no grooves	<b>CCFA 0.5</b>	<b>CCFD 0.5</b>
0,75 mm <sup>2</sup> AWG 18 one groove (back side)	<b>CCFA 0.7</b>	<b>CCFD 0.7</b>
1 mm <sup>2</sup> AWG 18 one groove	<b>CCFA 1.0</b>	<b>CCFD 1.0</b>
1,5 mm <sup>2</sup> AWG 16 two grooves	<b>CCFA 1.5</b>	<b>CCFD 1.5</b>
2,5 mm <sup>2</sup> AWG 14 three grooves	<b>CCFA 2.5</b>	<b>CCFD 2.5</b>
3 mm <sup>2</sup> AWG 12 one wide groove	<b>CCFA 3.0</b>	<b>CCFD 3.0</b>
4 mm <sup>2</sup> AWG 12 with no grooves	<b>CCFA 4.0</b>	<b>CCFD 4.0</b>
16A male crimp contacts		
0,14-0,37 mm <sup>2</sup> AWG 26-22 one groove	<b>CCMA 0.3</b>	<b>CCMD 0.3</b>
0,5 mm <sup>2</sup> AWG 20 with no grooves	<b>CCMA 0.5</b>	<b>CCMD 0.5</b>
0,75 mm <sup>2</sup> AWG 18 one groove (back side)	<b>CCMA 0.7</b>	<b>CCMD 0.7</b>
1 mm <sup>2</sup> AWG 18 one groove	<b>CCMA 1.0</b>	<b>CCMD 1.0</b>
1,5 mm <sup>2</sup> AWG 16 two grooves	<b>CCMA 1.5</b>	<b>CCMD 1.5</b>
2,5 mm <sup>2</sup> AWG 14 three grooves	<b>CCMA 2.5</b>	<b>CCMD 2.5</b>
3 mm <sup>2</sup> AWG 12 one wide groove	<b>CCMA 3.0</b>	<b>CCMD 3.0</b>
4 mm <sup>2</sup> AWG 12 with no grooves	<b>CCMA 4.0</b>	<b>CCMD 4.0</b>
16A male crimp contacts for advanced opening		
0,5 mm <sup>2</sup> AWG 20 with no grooves	<b>CC 0.5 AN</b>	+ for basic or high thickness gold plating, please refer to page 675
0,75 mm <sup>2</sup> AWG 18 one groove (back side)	<b>CC 0.7 AN</b>	
1 mm <sup>2</sup> AWG 18 one groove	<b>CC 1.0 AN</b>	
1,5 mm <sup>2</sup> AWG 16 two grooves	<b>CC 1.5 AN</b>	
2,5 mm <sup>2</sup> AWG 14 three grooves	<b>CC 2.5 AN</b>	

- characteristics according to EN 61984:
- 16A 500V 6kV 3**
- 16A 400/690V 6kV 2**
- certified
- rated voltage according to UL/CSA: 600V
- insulation resistance: ≥ 10 GΩ
- ambient temperature limit: -40 °C ... +125 °C
- made of self-extinguishing thermoplastic resin UL 94V-0
- mechanical life: ≥ 500 cycles
- contact resistance: ≤ 1 mΩ
- for max. current load see the connector inserts derating diagram below; for more information see page 28

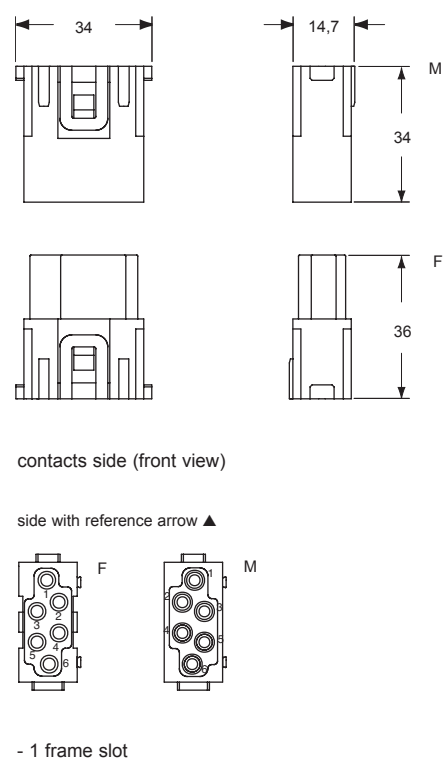
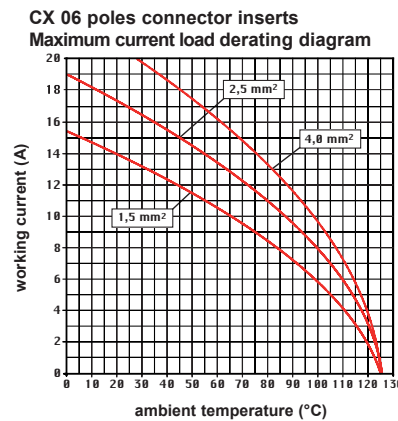

CCF and CCM		CC...AN	
conductor section (mm <sup>2</sup> )	conductor slot ø A (mm)	conductor section (mm <sup>2</sup> )	conductor slot ø A (mm)
0,14-0,37	0,9	0,5	1,1
0,5	1,1	0,75	1,3
1,0	1,45	1,0	1,45
1,5	1,8	1,5	1,8
2,5	2,2	2,5	2,2
3	2,55	3	2,55
4	2,85	4	2,85

# CX 06P CF/CM 6 poles protected 16A - 830V

The modular inserts must be installed in suitable frames which are then mounted in traditional enclosures or in COB panel support.  
Single-sized modular units may be directly mounted inside MIXO ONE enclosures.

frames for modular units page:  
286 - 287

MIXO ONE enclosures 369

- we recommend the use of CRF / CRM code pins together with relevant MIXO frame

- it is recommended to crimp the contacts with crimping tools homologated by ILME (please see the crimping tool section 16A contacts, CCF, CCM and CC...AN series) on pages 705 - 741

modular units, crimp connections

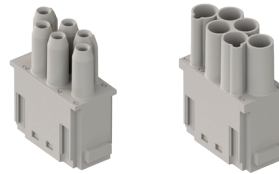

**RATING 830V**

16A crimp contacts standard or for advanced opening silver and gold plated



STANDARD



ADVANCED OPENING

description	part No.	part No.
without contacts (to be ordered separately)		
female inserts for female contacts	<b>CX 06P CF</b>	
male inserts for male contacts	<b>CX 06P CM</b>	
16A female contacts		
0,14-0,37 mm <sup>2</sup> AWG 26-22 one groove		<b>CCFA 0.3</b>
0,5 mm <sup>2</sup> AWG 20 with no grooves		<b>CCFA 0.5</b>
0,75 mm <sup>2</sup> AWG 18 one groove (back side)		<b>CCFA 0.7</b>
1 mm <sup>2</sup> AWG 18 one groove		<b>CCFA 1.0</b>
1,5 mm <sup>2</sup> AWG 16 two grooves		<b>CCFA 1.5</b>
2,5 mm <sup>2</sup> AWG 14 three grooves		<b>CCFA 2.5</b>
3 mm <sup>2</sup> AWG 12 one wide groove		<b>CCFA 3.0</b>
4 mm <sup>2</sup> AWG 12 with no grooves		<b>CCFA 4.0</b>
16A male contacts		
0,14-0,37 mm <sup>2</sup> AWG 26-22 one groove		<b>CCMA 0.3</b>
0,5 mm <sup>2</sup> AWG 20 with no grooves		<b>CCMA 0.5</b>
0,75 mm <sup>2</sup> AWG 18 one groove (back side)		<b>CCMA 0.7</b>
1 mm <sup>2</sup> AWG 18 one groove		<b>CCMA 1.0</b>
1,5 mm <sup>2</sup> AWG 16 two grooves		<b>CCMA 1.5</b>
2,5 mm <sup>2</sup> AWG 14 three grooves		<b>CCMA 2.5</b>
3 mm <sup>2</sup> AWG 12 one wide groove		<b>CCMA 3.0</b>
4 mm <sup>2</sup> AWG 12 with no grooves		<b>CCMA 4.0</b>
16A male crimp contacts for advanced opening		
0,5 mm <sup>2</sup> AWG 20 with no grooves		<b>CC 0.5 AN</b>
0,75 mm <sup>2</sup> AWG 18 one groove (back side)		<b>CC 0.7 AN</b>
1 mm <sup>2</sup> AWG 18 one groove		<b>CC 1.0 AN</b>
1,5 mm <sup>2</sup> AWG 16 two grooves		<b>CC 1.5 AN</b>
2,5 mm <sup>2</sup> AWG 14 three grooves		<b>CC 2.5 AN</b>
		<b>CCFA 0.3</b>
		<b>CCFA 0.5</b>
		<b>CCFA 0.7</b>
		<b>CCFA 1.0</b>
		<b>CCFA 1.5</b>
		<b>CCFA 2.5</b>
		<b>CCFA 3.0</b>
		<b>CCFA 4.0</b>
		<b>CCMA 0.3</b>
		<b>CCMA 0.5</b>
		<b>CCMA 0.7</b>
		<b>CCMA 1.0</b>
		<b>CCMA 1.5</b>
		<b>CCMA 2.5</b>
		<b>CCMA 3.0</b>
		<b>CCMA 4.0</b>
		<b>CCMD 0.3</b>
		<b>CCMD 0.5</b>
		<b>CCMD 0.7</b>
		<b>CCMD 1.0</b>
		<b>CCMD 1.5</b>
		<b>CCMD 2.5</b>
		<b>CCMD 3.0</b>
		<b>CCMD 4.0</b>
		<b>CC 0.5 AN</b>
		<b>CC 0.7 AN</b>
		<b>CC 1.0 AN</b>
		<b>CC 1.5 AN</b>
		<b>CC 2.5 AN</b>
		<b>silver plated</b>
		<b>gold plated+</b>
		+ for basic or high thickness gold plating, please refer to page 675

- characteristics according to EN 61984:

**16A 830V 8kV 3**

- certified
- rated voltage according to UL/CSA: 600V
- insulation resistance: ≥ 10 GΩ
- ambient temperature limit: -40 °C ... +125 °C
- made of self-extinguishing thermoplastic resin UL 94V-0
- mechanical life: ≥ 500 cycles \*
- \* with silver or standard gold plated contacts
- in combination with removable crimp contacts series RC and mounted inside MIXO frames for HNM, it may be used as an HNM insert, up to 10.000 mating cycles
- contact resistance: ≤ 1 mΩ
- for max. current load see the connector inserts derating diagram below; for more information see page 28

**CX 06 poles connector inserts**  
**Maximum current load derating diagram**

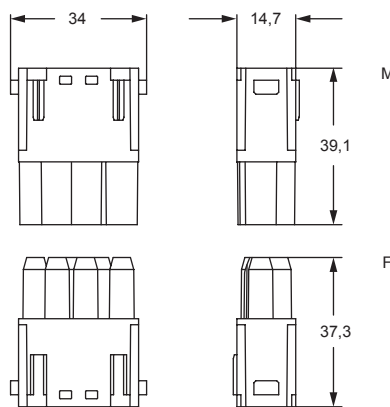
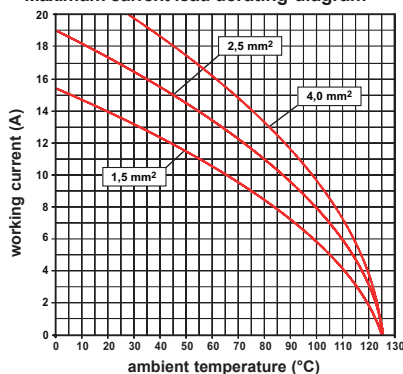

contacts side (front view)

side with reference arrow ▲

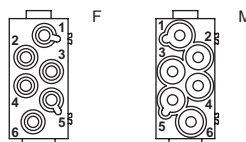

- 1 frame slot

**CCF and CCM**

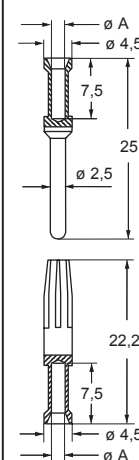

**CC...AN**

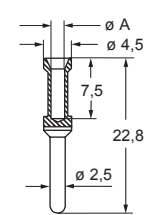

**CCF, CCM and CC...AN contacts**

conductor section (mm <sup>2</sup> )	conductor slot ø A (mm)	conductors stripping length (mm)
0,14-0,37	0,9	7,5
0,5	1,1	7,5
0,75	1,3	7,5
1,0	1,45	7,5
1,5	1,8	7,5
2,5	2,2	7,5
3	2,55	7,5
4	2,85	7,5

MIXO

# CX 08 CF/CM 8 poles 16A - 400V

The modular inserts must be installed in suitable frames which are then mounted in traditional enclosures or in COB panel support.  
Single-sized modular units may be directly mounted inside MIXO ONE enclosures.

frames for modular units page: 286 - 287  
MIXO ONE enclosures 369

- it is recommended to crimp the contacts with crimping tools homologated by ILME (please see the crimping tool section 16A contacts, CCF, CCM and CC...AN series) on pages 705 - 741

## modular units, crimp connections

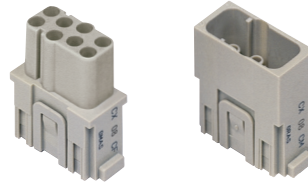

## 16A crimp contacts standard or for advanced opening silver and gold plated

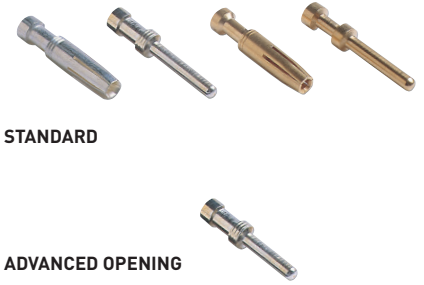

STANDARD

ADVANCED OPENING

description	part No.	part No.
without contacts (to be ordered separately)		
female inserts for female contacts	<b>CX 08 CF</b>	
male inserts for male contacts	<b>CX 08 CM</b>	
16A female crimp contacts		
0,14-0,37 mm <sup>2</sup> AWG 26-22 one groove		<b>CCFA 0.3</b>
0,5 mm <sup>2</sup> AWG 20 with no grooves		<b>CCFA 0.5</b>
0,75 mm <sup>2</sup> AWG 18 one groove (back side)		<b>CCFA 0.7</b>
1 mm <sup>2</sup> AWG 18 one groove		<b>CCFA 1.0</b>
1,5 mm <sup>2</sup> AWG 16 two grooves		<b>CCFA 1.5</b>
2,5 mm <sup>2</sup> AWG 14 three grooves		<b>CCFA 2.5</b>
3 mm <sup>2</sup> AWG 12 one wide groove		<b>CCFA 3.0</b>
4 mm <sup>2</sup> AWG 12 with no grooves		<b>CCFA 4.0</b>
16A male crimp contacts		
0,14-0,37 mm <sup>2</sup> AWG 26-22 one groove		<b>CCMA 0.3</b>
0,5 mm <sup>2</sup> AWG 20 with no grooves		<b>CCMA 0.5</b>
0,75 mm <sup>2</sup> AWG 18 one groove (back side)		<b>CCMA 0.7</b>
1 mm <sup>2</sup> AWG 18 one groove		<b>CCMA 1.0</b>
1,5 mm <sup>2</sup> AWG 16 two grooves		<b>CCMA 1.5</b>
2,5 mm <sup>2</sup> AWG 14 three grooves		<b>CCMA 2.5</b>
3 mm <sup>2</sup> AWG 12 one wide groove		<b>CCMA 3.0</b>
4 mm <sup>2</sup> AWG 12 with no grooves		<b>CCMA 4.0</b>
16A male crimp contacts for advanced opening		
0,5 mm <sup>2</sup> AWG 20 with no grooves		<b>CC 0.5 AN</b>
0,75 mm <sup>2</sup> AWG 18 one groove (back side)		<b>CC 0.7 AN</b>
1 mm <sup>2</sup> AWG 18 one groove		<b>CC 1.0 AN</b>
1,5 mm <sup>2</sup> AWG 16 two grooves		<b>CC 1.5 AN</b>
2,5 mm <sup>2</sup> AWG 14 three grooves		<b>CC 2.5 AN</b>

silver plated

gold plated+

† for basic or high thickness gold plating, please refer to page 675

- characteristics according to EN 61984:

**16A 400V 6kV 3**  
**16A 400/690V 6kV 2**

- certified

- rated voltage according to UL/CSA: 600V
- insulation resistance: ≥ 10 GΩ
- ambient temperature limit: -40 °C ... +125 °C
- made of self-extinguishing thermoplastic resin UL 94V-0
- mechanical life: ≥ 500 cycles
- contact resistance: ≤ 1 mΩ
- for max. current load see the connector inserts derating diagram below; for more information see page 28

**CX 08 poles connector inserts**  
**Maximum current load derating diagram**

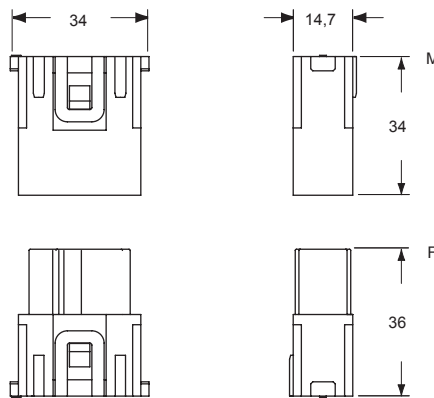
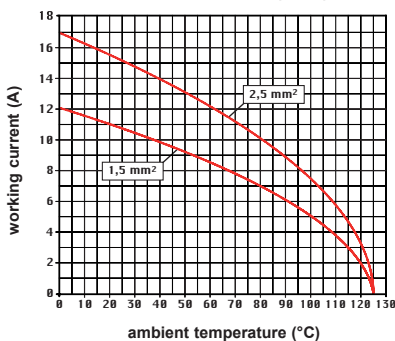

contacts side (front view)

side with reference arrow ▲

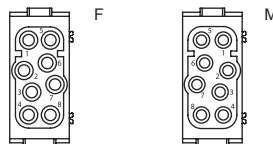

- 1 frame slot

### CCF and CCM

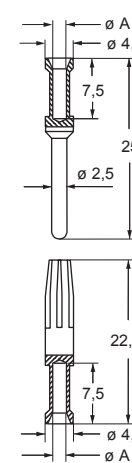

### CC...AN

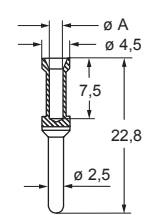

### CCF, CCM and CC...AN contacts

conductor section (mm <sup>2</sup> )	conductor slot ø A (mm)	conductors stripping length (mm)
0,14-0,37	0,9	7,5
0,5	1,1	7,5
0,75	1,3	7,5
1,0	1,45	7,5
1,5	1,8	7,5
2,5	2,2	7,5
3	2,55	7,5
4	2,85	7,5



# CX 20 CF/CM 20 poles 16A - 500V

The modular inserts must be installed in suitable frames, which are then mounted in traditional enclosures or in COB panel supports.

frames for modular units page:  
286 - 287

- it is recommended to crimp the contacts with crimping tools homologated by ILME (please see the crimping tool section 16A contacts, CCF, CCM and CC...AN series) on pages 705 - 741

modular units, crimp connections

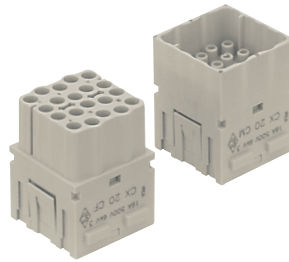

16A crimp contacts standard or for advanced opening silver and gold plated



STANDARD

ADVANCED OPENING

description	part No.	part No.
-------------	----------	----------

without contacts (to be ordered separately)

female inserts for female contacts \*

**CX 20 CF**  
**CX 20 CM**

male inserts for male contacts \*

16A female crimp contacts

Area (mm²)	AWG	Configuration
0,14-0,37	26-22	one groove
0,5	20	with no grooves
0,75	18	one groove (back side)
1	18	one groove
1,5	16	two grooves
2,5	14	three grooves
3	12	one wide groove
4	12	with no grooves

16A male crimp contacts

Area (mm²)	AWG	Configuration
0,14-0,37	26-22	one groove
0,5	20	with no grooves
0,75	18	one groove (back side)
1	18	one groove
1,5	16	two grooves
2,5	14	three grooves
3	12	one wide groove
4	12	with no grooves

16A male crimp contacts for advanced opening

Area (mm²)	AWG	Configuration
0,5	20	with no grooves
0,75	18	one groove (back side)
1	18	one groove
1,5	16	two grooves
2,5	14	three grooves

CCFA 0.3  
CCFA 0.5  
CCFA 0.7  
CCFA 1.0  
CCFA 1.5  
CCFA 2.5  
CCFA 3.0  
CCFA 4.0

silver plated

CCFD 0.3  
CCFD 0.5  
CCFD 0.7  
CCFD 1.0  
CCFD 1.5  
CCFD 2.5  
CCFD 3.0  
CCFD 4.0

gold plated+

CCMA 0.3  
CCMA 0.5  
CCMA 0.7  
CCMA 1.0  
CCMA 1.5  
CCMA 2.5  
CCMA 3.0  
CCMA 4.0

CCMD 0.3  
CCMD 0.5  
CCMD 0.7  
CCMD 1.0  
CCMD 1.5  
CCMD 2.5  
CCMD 3.0  
CCMD 4.0

CC 0.5 AN  
CC 0.7 AN  
CC 1.0 AN  
CC 1.5 AN  
CC 2.5 AN

+ for basic or high thickness gold plating, please refer to page 675

\* on request, version with 3 fastened CX 20 CF/CM inserts with poles numbered from 1 - 60  
references: **CX 60 CF**, **CX 60 CM**

- characteristics according to EN 61984:

**16A 500V 6kV 3**  
**16A 830V 8kV 2**

- **UL** (UL for USA and Canada), **CEC**, **DNV-GL**

- **UL** certified
- rated voltage according to UL/CSA: 600V
- insulation resistance:  $\geq 10 \text{ G}\Omega$
- ambient temperature limit:  $-40 \text{ }^\circ\text{C} \dots +125 \text{ }^\circ\text{C}$
- made of self-extinguishing thermoplastic resin UL 94V-0
- mechanical life:  $\geq 500$  cycles
- contact resistance:  $\leq 1 \text{ m}\Omega$
- for max. current load see the connector inserts derating diagram below; for more information see page 28

**CX20 poles connector inserts**  
**Maximum current load derating diagram**

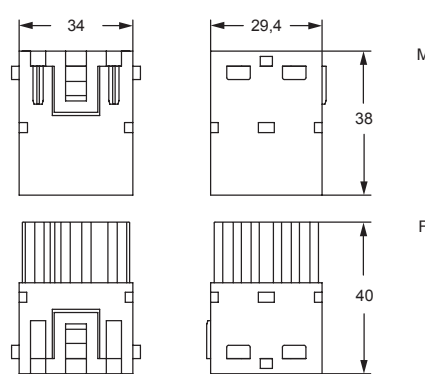
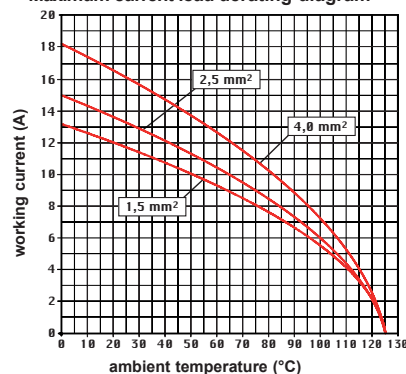

contacts side (front view)

side with reference arrow ▲

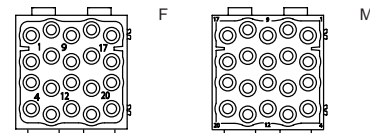

- 2 frame slots

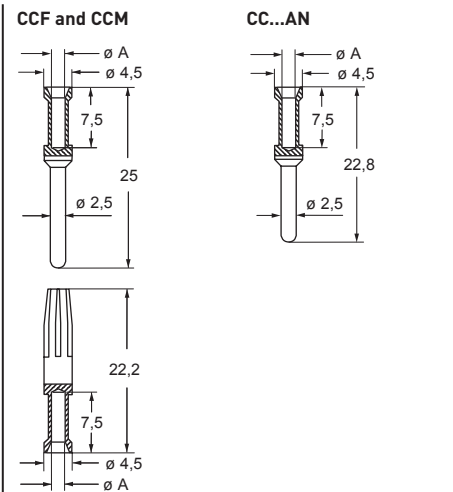

**CCF, CCM and CC..AN contacts**

conductor section (mm²)	conductor slot ø A (mm)	conductors stripping length (mm)
0,14-0,37	0,9	7,5
0,5	1,1	7,5
0,75	1,3	7,5
1,0	1,45	7,5
1,5	1,8	7,5
2,5	2,2	7,5
3	2,55	7,5
4	2,85	7,5



# HV 2 poles single module 16A - 2500V

The modular inserts must be installed in suitable frames which are then mounted in traditional enclosures\* or in COB panel support.  
Single-sized modular units may be directly mounted inside MIXO ONE enclosures.

frames for modular units*	page: 286 - 287
MIXO ONE enclosures	369

\* enclosures: bulkhead mounting housings, high construction housings or high construction hoods

## high voltage modular units, crimp connections

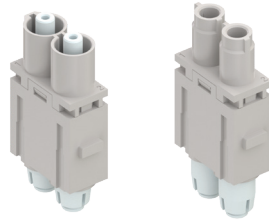

## 16A crimp contacts silver and gold plated



description	part No.	part No.
without contacts (to be ordered separately)		
high voltage female inserts for female contacts	<b>CX 02 CHF</b>	
high voltage male inserts for male contacts	<b>CX 02 CHM</b>	
contact holder removal tool	<b>CH1ES</b>	
16A female crimp contacts		
0,5 mm <sup>2</sup> AWG 20 with no grooves		<b>CCFA 0.5</b>
0,75 mm <sup>2</sup> AWG 18 one groove (back side)		<b>CCFA 0.7</b>
1 mm <sup>2</sup> AWG 18 one groove		<b>CCFA 1.0</b>
1,5 mm <sup>2</sup> AWG 16 two grooves		<b>CCFA 1.5</b>
2,5 mm <sup>2</sup> AWG 14 three grooves		<b>CCFA 2.5</b>
3 mm <sup>2</sup> AWG 12 one wide groove		<b>CCFA 3.0</b>
4 mm <sup>2</sup> AWG 12 with no grooves		<b>CCFA 4.0</b>
16A male crimp contacts		
0,5 mm <sup>2</sup> AWG 20 with no grooves		<b>CCMA 0.5</b>
0,75 mm <sup>2</sup> AWG 18 one groove (back side)		<b>CCMA 0.7</b>
1 mm <sup>2</sup> AWG 18 one groove		<b>CCMA 1.0</b>
1,5 mm <sup>2</sup> AWG 16 two grooves		<b>CCMA 1.5</b>
2,5 mm <sup>2</sup> AWG 14 three grooves		<b>CCMA 2.5</b>
3 mm <sup>2</sup> AWG 12 one wide groove		<b>CCMA 3.0</b>
4 mm <sup>2</sup> AWG 12 with no grooves		<b>CCMA 4.0</b>

- characteristics according to EN 61984\*\*:
- 16A 2500V 15kV 3**
- \*\* used for guidance as applicable
- cURus, CSA, CQC, DNV-GL, BV, EAC pending
- insulation resistance:  $\geq 10 \text{ G}\Omega$
- ambient temperature limit:  $-40 \text{ }^\circ\text{C} \dots +125 \text{ }^\circ\text{C}$
- made of self-extinguishing thermoplastic resin UL 94V-0
- mechanical life:  $\geq 500$  cycles
- contact resistance:  $\leq 1 \text{ m}\Omega$
- **it is recommended to crimp the contacts with crimping tools homologated by ILME** (please see the crimping tool section 16A contacts, CCF and CCM series) on pages 705 - 741
- contact holder removal tool: **CH1ES**

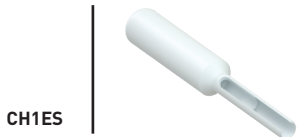

CH1ES

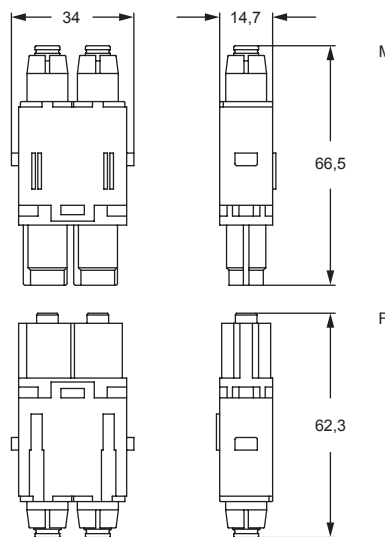

contacts side (front view)

side with reference arrow ▲

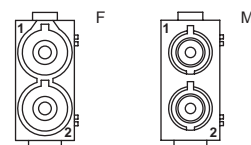

- 1 frame slot

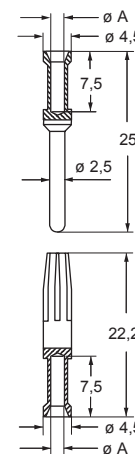

### CCF and CCM contacts

conductor section (mm <sup>2</sup> )	conductor slot $\varnothing A$ (mm)	conductors stripping length (mm)
0,5	1,1	9,5
0,75	1,3	9,5
1,0	1,45	9,5
1,5	1,8	9,5
2,5	2,2	9,5
3	2,55	9,5
4	2,85	9,5

+ for basic or high thickness gold plating, please refer to page 675



Watch our online tutorial

# HV 2 poles 16A - 2900/5000V

The modular inserts must be installed in suitable frames, which are then mounted in traditional enclosures\* or in COB panel supports.

frames for modular units\*

page:  
286

high voltage modular units,  
crimp connections  
contact holder removal tool



16A crimp contacts  
silver and gold plated



\* enclosures: bulkhead mounting housings, high construction housings or high construction hoods

description	part No.	part No.
-------------	----------	----------

without contacts (to be ordered separately)  
high voltage female inserts for female contacts  
high voltage male inserts for male contacts

CX 02 HF  
CX 02 HM

contact holder removal tool

CHES

16A female crimp contacts

Area (mm²)	AWG	Characteristics
0,5	20	with no grooves
0,75	18	one groove (back side)
1	18	one groove
1,5	16	two grooves
2,5	14	three grooves
3	12	one wide groove
4	12	with no grooves

CCFA 0.5  
CCFA 0.7  
CCFA 1.0  
CCFA 1.5  
CCFA 2.5  
CCFA 3.0  
CCFA 4.0

silver plated

CCFD 0.5  
CCFD 0.7  
CCFD 1.0  
CCFD 1.5  
CCFD 2.5  
CCFD 3.0  
CCFD 4.0

gold plated+

16A male crimp contacts

Area (mm²)	AWG	Characteristics
0,5	20	with no grooves
0,75	18	one groove (back side)
1	18	one groove
1,5	16	two grooves
2,5	14	three grooves
3	12	one wide groove
4	12	with no grooves

CCMA 0.5  
CCMA 0.7  
CCMA 1.0  
CCMA 1.5  
CCMA 2.5  
CCMA 3.0  
CCMA 4.0

CCMD 0.5  
CCMD 0.7  
CCMD 1.0  
CCMD 1.5  
CCMD 2.5  
CCMD 3.0  
CCMD 4.0

- characteristics according to EN 61984\*\*:

**16A 2900/5000V 15kV 3**

\*\* used for guidance as applicable

- cURus, CSA, CQC, DNV-GL, BV, EAC pending
- insulation resistance:  $\geq 10 \text{ G}\Omega$
- ambient temperature limit:  $-40 \text{ }^\circ\text{C} \dots +125 \text{ }^\circ\text{C}$
- made of self-extinguishing thermoplastic resin UL 94V-0
- mechanical life:  $\geq 500$  cycles
- contact resistance:  $\leq 1 \text{ m}\Omega$
- **it is recommended to crimp the contacts with crimping tools homologated by ILME** (please see the crimping tool section 16A contacts, CCF and CCM series) on pages 705 - 741
- contact holder removal tool: **CHES**

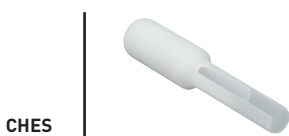
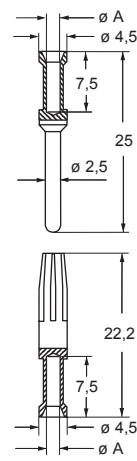
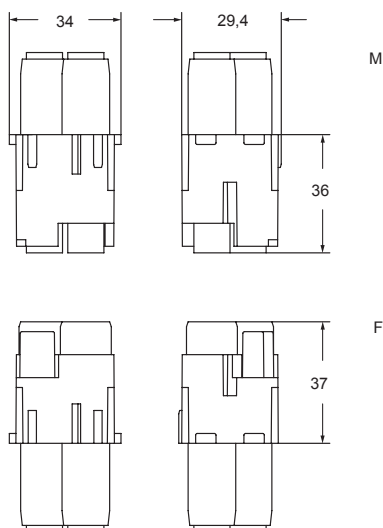

CHES

contacts side (front view)

side with reference arrow ▲

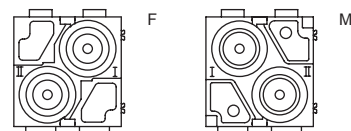

- 2 frame slots

**CCF and CCM contacts**

conductor section (mm²)	conductor slot $\varnothing A$ (mm)	conductors stripping length (mm)
0,14-0,37	0,9	9,5
0,5	1,1	9,5
0,75	1,3	9,5
1,0	1,45	9,5
1,5	1,8	9,5
2,5	2,2	9,5
3	2,55	9,5
4	2,85	9,5

+ for basic or high thickness gold plating, please refer to page 675

# CX 12 DF/DM 12 poles 10A - 250V

The modular inserts must be installed in suitable frames which are then mounted in traditional enclosures\* or in COB panel support.  
Single-sized modular units may be directly mounted inside MIXO ONE enclosures.

frames for modular units*	page: 286 - 287
MIXO ONE enclosures	369

\* enclosures: bulkhead mounting housings, high construction housings or high construction hoods

modular units,  
crimp connections

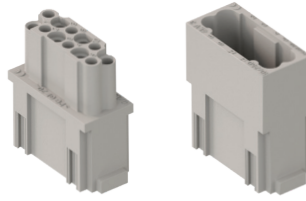

**RATING 250V**

10A crimp contacts,  
silver and gold plated



description	part No.	part No.
without contacts (to be ordered separately)		
female inserts for female contacts	<b>CX 12 DF</b>	
male inserts for male contacts	<b>CX 12 DM</b>	
10A female crimp contacts		
0,14-0,37 mm <sup>2</sup> AWG 26-22 identification No. 1	<b>CDFA 0.3</b>	<b>CDFD 0.3</b>
0,5 mm <sup>2</sup> AWG 20 identification No. 2	<b>CDFA 0.5</b>	<b>CDFD 0.5</b>
0,75 mm <sup>2</sup> AWG 18 identification No. ②	<b>CDFA 0.7</b>	<b>CDFD 0.7</b>
1 mm <sup>2</sup> AWG 18 identification No. 3	<b>CDFA 1.0</b>	<b>CDFD 1.0</b>
1,5 mm <sup>2</sup> AWG 16 identification No. 4	<b>CDFA 1.5</b>	<b>CDFD 1.5</b>
2,5 mm <sup>2</sup> AWG 14 identification No. 5	<b>CDFA 2.5</b>	<b>CDFD 2.5</b>
10A male crimp contacts		
0,14-0,37 mm <sup>2</sup> AWG 26-22 identification No. 1	<b>CDMA 0.3</b>	<b>CDMD 0.3</b>
0,5 mm <sup>2</sup> AWG 20 identification No. 2	<b>CDMA 0.5</b>	<b>CDMD 0.5</b>
0,75 mm <sup>2</sup> AWG 18 identification No. ②	<b>CDMA 0.7</b>	<b>CDMD 0.7</b>
1 mm <sup>2</sup> AWG 18 identification No. 3	<b>CDMA 1.0</b>	<b>CDMD 1.0</b>
1,5 mm <sup>2</sup> AWG 16 identification No. 4	<b>CDMA 1.5</b>	<b>CDMD 1.5</b>
2,5 mm <sup>2</sup> AWG 14 identification No. 5	<b>CDMA 2.5</b>	<b>CDMD 2.5</b>

- characteristics according to EN 61984:  
**10A 160V 2,5kV 3**  
**10A 250V 4kV 2**
- certified
- rated voltage according to UL/CSA: 600V
- insulation resistance: ≥ 10 GΩ
- ambient temperature limit: -40 °C ... +125 °C
- made of self-extinguishing thermoplastic resin UL 94V-0
- mechanical life: ≥ 500 cycles
- contact resistance: ≤ 3 mΩ
- PCBs interface, refer to article CIF 2.4 on page 670
- **it is recommended to crimp the contacts with crimping tools homologated by ILME** (please see the crimping tool section 10A contacts, CDF and CDM series) on pages 705 - 741
- for max. current load see the connector inserts derating diagram below; for more information see page 28

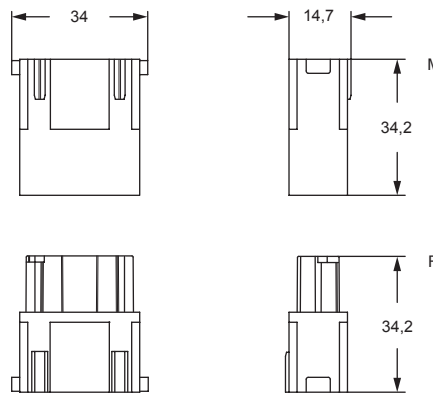

contacts side (front view)

side with reference arrow ▲

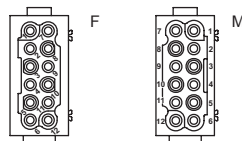

- 1 frame slot

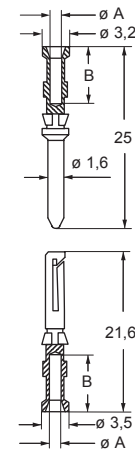

**CDF and CDM contacts**

conductor section (mm <sup>2</sup> )	conductor slot ø A (mm)	conductors stripping length B (mm)
0,14-0,37	0,9	8
0,5	1,1	8
0,75	1,3	8
1,0	1,45	8
1,5	1,8	8
2,5	2,2	6

† for basic or high thickness gold plating, please refer to page 674

**CX 12 poles connector inserts**  
**Maximum current load derating diagram**

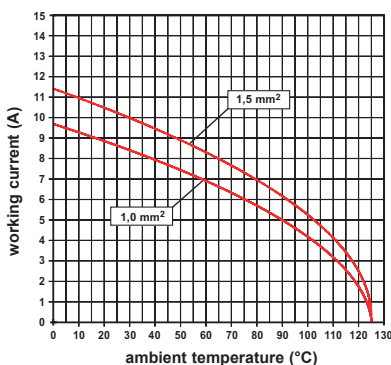

# CX 17 DF/DM 17 poles 10A - 160V

The modular inserts must be installed in suitable frames which are then mounted in traditional enclosures or in COB panel support.  
Single-sized modular units may be directly mounted inside MIXO ONE enclosures.

frames for modular units page: 286 - 287  
MIXO ONE enclosures 369

modular units,  
crimp connections

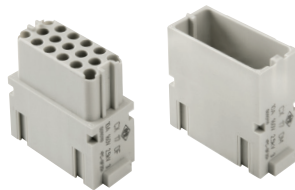

10A crimp contacts,  
silver and gold plated



description	part No.	part No.
-------------	----------	----------

without contacts (to be ordered separately)		
female inserts for female contacts	<b>CX 17 DF</b>	
male inserts for male contacts	<b>CX 17 DM</b>	
10A female crimp contacts		
0,14-0,37 mm <sup>2</sup> AWG 26-22 identification No. 1	<b>CDFA 0.3</b>	<b>CDFD 0.3</b>
0,5 mm <sup>2</sup> AWG 20 identification No. 2	<b>CDFA 0.5</b>	<b>CDFD 0.5</b>
0,75 mm <sup>2</sup> AWG 18 identification No. ②	<b>CDFA 0.7</b>	<b>CDFD 0.7</b>
1 mm <sup>2</sup> AWG 18 identification No. 3	<b>CDFA 1.0</b>	<b>CDFD 1.0</b>
1,5 mm <sup>2</sup> AWG 16 identification No. 4	<b>CDFA 1.5</b>	<b>CDFD 1.5</b>
2,5 mm <sup>2</sup> AWG 14 identification No. 5	<b>CDFA 2.5</b>	<b>CDFD 2.5</b>
	<b>silver plated</b>	<b>gold plated+</b>
10A male crimp contacts		
0,14-0,37 mm <sup>2</sup> AWG 26-22 identification No. 1	<b>CDMA 0.3</b>	<b>CDMD 0.3</b>
0,5 mm <sup>2</sup> AWG 20 identification No. 2	<b>CDMA 0.5</b>	<b>CDMD 0.5</b>
0,75 mm <sup>2</sup> AWG 18 identification No. ②	<b>CDMA 0.7</b>	<b>CDMD 0.7</b>
1 mm <sup>2</sup> AWG 18 identification No. 3	<b>CDMA 1.0</b>	<b>CDMD 1.0</b>
1,5 mm <sup>2</sup> AWG 16 identification No. 4	<b>CDMA 1.5</b>	<b>CDMD 1.5</b>
2,5 mm <sup>2</sup> AWG 14 identification No. 5	<b>CDMA 2.5</b>	<b>CDMD 2.5</b>

- characteristics according to EN 61984:
- 10A 160V 2,5kV 3**
- 10A 250V 4kV 2**
- (UL for USA and Canada), certified
- rated voltage according to UL/CSA: 250V
- insulation resistance: ≥ 10 GΩ
- ambient temperature limit: -40 °C ... +125 °C
- made of self-extinguishing thermoplastic resin UL 94V-0
- mechanical life: ≥ 500 cycles
- contact resistance: ≤ 3 mΩ
- **it is recommended to crimp the contacts with crimping tools homologated by ILME** (please see the crimping tool section 10A contacts, CDF and CDM series) on pages 705 - 741
- for max. current load see the connector inserts derating diagram below; for more information see page 28

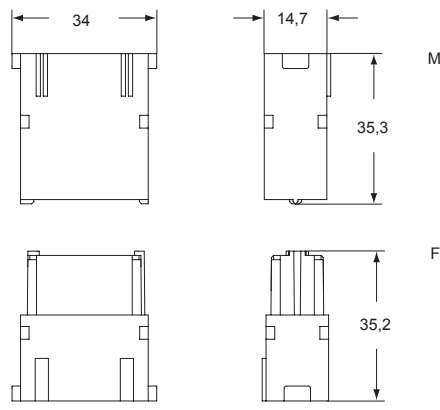

contacts side (front view)

side with reference arrow ▲

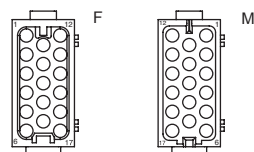

- 1 frame slot

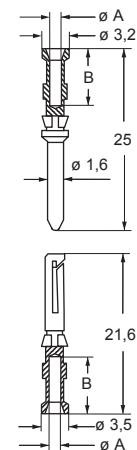

**CDF and CDM contacts**

conductor section (mm <sup>2</sup> )	conductor slot $\varnothing$ A (mm)	conductors stripping length B (mm)
0,14-0,37	0,9	8
0,5	1,1	8
0,75	1,3	8
1,0	1,45	8
1,5	1,8	8
2,5	2,2	6

+ for basic or high thickness gold plating, please refer to page 674

**CX 17 poles connector inserts**  
Maximum current load derating diagram

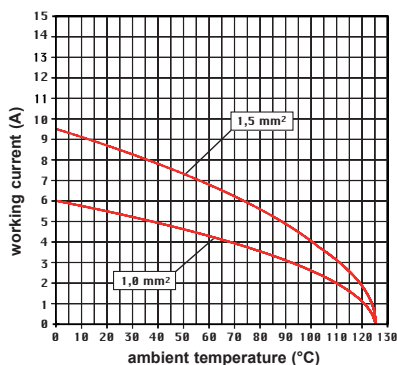

# CX 42 DF/DM 42 poles 10A - 150V

The modular inserts must be installed in suitable frames, which are then mounted in traditional enclosures\* or in COB panel supports.

frames for modular units\*

page: 286

modular units, crimp connections

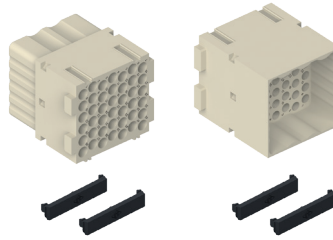

10A crimp contacts, silver and gold plated



AVAILABLE MAY 2019

description	part No.	part No.
-------------	----------	----------

without contacts (to be ordered separately), supplied with 2 dedicated black coloured 2-slot sized lock-in tabs  
female inserts for female contacts  
male inserts for male contacts

CX 42 DF  
CX 42 DM

10A female crimp contacts

0,14-0,37 mm <sup>2</sup>	AWG 26-22	identification No. 1
0,5 mm <sup>2</sup>	AWG 20	identification No. 2
0,75 mm <sup>2</sup>	AWG 18	identification No. ②
1 mm <sup>2</sup>	AWG 18	identification No. 3
1,5 mm <sup>2</sup>	AWG 16	identification No. 4
2,5 mm <sup>2</sup>	AWG 14	identification No. 5

CDFA 0.3  
CDFA 0.5  
CDFA 0.7  
CDFA 1.0  
CDFA 1.5  
CDFA 2.5

silver plated

CDFD 0.3  
CDFD 0.5  
CDFD 0.7  
CDFD 1.0  
CDFD 1.5  
CDFD 2.5

gold plated<sup>+</sup>

10A male crimp contacts

0,14-0,37 mm <sup>2</sup>	AWG 26-22	identification No. 1
0,5 mm <sup>2</sup>	AWG 20	identification No. 2
0,75 mm <sup>2</sup>	AWG 18	identification No. ②
1 mm <sup>2</sup>	AWG 18	identification No. 3
1,5 mm <sup>2</sup>	AWG 16	identification No. 4
2,5 mm <sup>2</sup>	AWG 14	identification No. 5

CDMA 0.3  
CDMA 0.5  
CDMA 0.7  
CDMA 1.0  
CDMA 1.5  
CDMA 2.5

CDMD 0.3  
CDMD 0.5  
CDMD 0.7  
CDMD 1.0  
CDMD 1.5  
CDMD 2.5

- characteristics according to EN 61984: **10A 150V 2,5kV 3**
- cURus, CSA, CQC, DNV-GL, BV, EAC pending
- rated voltage according to UL/CSA: 250V
- insulation resistance:  $\geq 10 \text{ G}\Omega$
- ambient temperature limit:  $-40 \text{ }^\circ\text{C} \dots +125 \text{ }^\circ\text{C}$
- made of self-extinguishing thermoplastic resin UL 94V-0
- mechanical life:  $\geq 500$  cycles
- contact resistance:  $\leq 3 \text{ m}\Omega$
- **it is recommended to crimp the contacts with crimping tools homologated by ILME** (please see the crimping tool section 10A contacts, CDF and CDM series) on pages 705 - 741

- suitable for realizing **HNM** connectors (High Number of Matings up to 10 000 cycles) when used in combination with: HNM MIXO frames, HNM crimp contacts RD series and HNM enclosures;

- supplied with dedicated black coloured 2-slot sized lock-in tabs (2, one per each side).

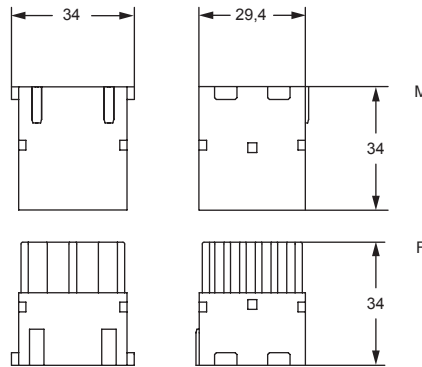

contacts side (front view)

rear view, side with reference arrow ▲

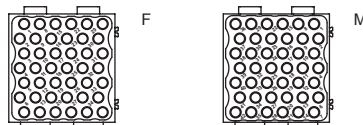

- 2 frame slots

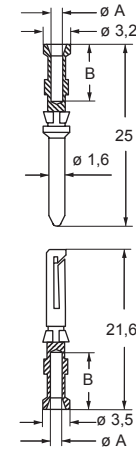

**CDF and CDM contacts**

conductor section (mm <sup>2</sup> )	conductor slot $\varnothing A$ (mm)	conductors stripping length B (mm)
0,14-0,37	0,9	8
0,5	1,1	8
0,75	1,3	8
1,0	1,45	8
1,5	1,8	8
2,5	2,2	6

<sup>+</sup> for basic or high thickness gold plating, please refer to page 674

# CX 25 IBF/IBM 25 poles 4A - 50V

The modular inserts must be installed in suitable frames which are then mounted in traditional enclosures or in COB panel support.  
Single-sized modular units may be directly mounted inside MIXO ONE enclosures.

frames for modular units page: 286 - 287  
MIXO ONE enclosures 369

- max insulating diameter 2,1 mm
- we recommend the use of CRF / CRM code pins

modular units,  
crimp connections

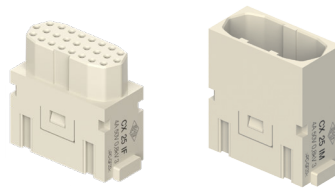

CI (4A) crimp contacts,  
silver and gold plated



description	part No.	part No.
-------------	----------	----------

without contacts (to be ordered separately)  
female inserts for female contacts  
male inserts for male contacts

**CX 25 IBF**  
**CX 25 IBM**

CI (4A) female crimp contacts  
0,08-0,21 mm<sup>2</sup> AWG 28-24  
0,13-0,33 mm<sup>2</sup> AWG 26-22  
0,33-0,52 mm<sup>2</sup> AWG 22-20  
0,52-0,75 mm<sup>2</sup> AWG 20-18

**CIFA 0.2**  
**CIFA 0.3**  
**CIFA 0.5**  
**CIFA 0.7**

silver plated

**CIFD 0.2**  
**CIFD 0.3**  
**CIFD 0.5**  
**CIFD 0.7**

gold plated

CI (4A) male crimp contacts  
0,08-0,21 mm<sup>2</sup> AWG 28-24  
0,13-0,33 mm<sup>2</sup> AWG 26-22  
0,33-0,52 mm<sup>2</sup> AWG 22-20  
0,52-0,75 mm<sup>2</sup> AWG 20-18

**CIMA 0.2**  
**CIMA 0.3**  
**CIMA 0.5**  
**CIMA 0.7**

**CIMD 0.2**  
**CIMD 0.3**  
**CIMD 0.5**  
**CIMD 0.7**

- characteristics according to EN 61984:

**4A 50V 0,8kV 3**  
**4A 160V 2,5kV 2**

- certified
- insulation resistance:  $\geq 10 \text{ G}\Omega$
- ambient temperature limit:  $-40 \text{ }^\circ\text{C} \dots +125 \text{ }^\circ\text{C}$
- made of self-extinguishing thermoplastic resin UL 94V-0
- mechanical life:  $\geq 500$  cycles
- for crimp contacts CI series use, on page 716 - 719
- **CIPZ D** crimping tool
- **CITP D** turret head
- **CIES** insertion / removal tool for contacts 0,2 - 0,5 mm<sup>2</sup>
- **CIES B** insertion / removal tool for contacts 0,75 mm<sup>2</sup>
- for max. current load see the connector inserts derating diagram below; for more information see page 28

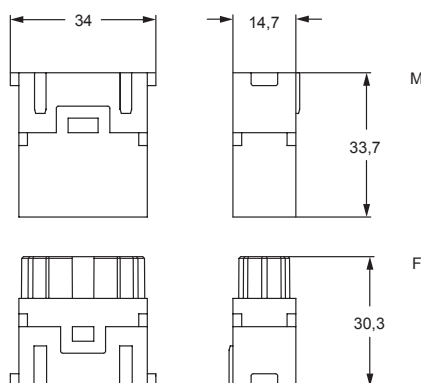

contacts side (front view)

side with reference arrow ▲

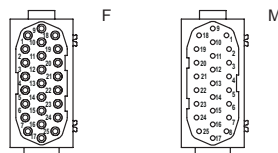

- 1 frame slot

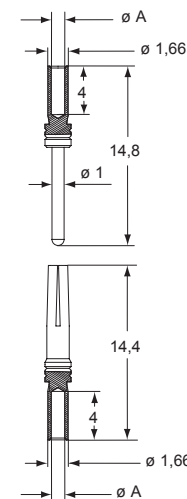

**CIF and CIM contacts**

conductor section (mm <sup>2</sup> )	conductor slot ø A (mm)	conductors stripping length (mm)
0,08-0,21	0,64	4
0,13-0,33	0,90	4
0,33-0,52	1,12	4
0,52-0,75	1,12	4

**CX IBF/IBM 25 poles connector inserts**  
**Maximum current load derating diagram**

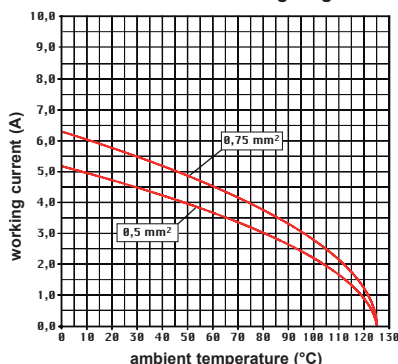

MIXO



# CX 25 IF/IM 25 poles 4A - 50V

The modular inserts must be installed in suitable frames which are then mounted in traditional enclosures or in COB panel support.  
Single-sized modular units may be directly mounted inside MIXO ONE enclosures.

frames for modular units page: 286 - 287  
MIXO ONE enclosures 369

- we recommend the use of CRF / CRM code pins

modular units,  
crimp connections

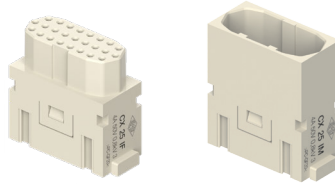

CI (4A) crimp contacts,  
silver and gold plated



description	part No.	part No.
without contacts (to be ordered separately)		
female inserts for female contacts	<b>CX 25 IF</b>	
male inserts for male contacts	<b>CX 25 IM</b>	
CI (4A) female crimp contacts		
0,08-0,21 mm <sup>2</sup> AWG 28-24		<b>CIFA 0.2</b> <span style="background-color: #d3d3d3; padding: 2px;">silver plated</span> <b>CIFD 0.2</b> <span style="background-color: #ffd700; padding: 2px;">gold plated</span>
0,13-0,33 mm <sup>2</sup> AWG 26-22		<b>CIFA 0.3</b> <span style="background-color: #d3d3d3; padding: 2px;">silver plated</span> <b>CIFD 0.3</b> <span style="background-color: #ffd700; padding: 2px;">gold plated</span>
0,33-0,52 mm <sup>2</sup> AWG 22-20		<b>CIFA 0.5</b> <span style="background-color: #d3d3d3; padding: 2px;">silver plated</span> <b>CIFD 0.5</b> <span style="background-color: #ffd700; padding: 2px;">gold plated</span>
CI (4A) male crimp contacts		
0,08-0,21 mm <sup>2</sup> AWG 28-24		<b>CIMA 0.2</b> <span style="background-color: #d3d3d3; padding: 2px;">silver plated</span> <b>CIMD 0.2</b> <span style="background-color: #ffd700; padding: 2px;">gold plated</span>
0,13-0,33 mm <sup>2</sup> AWG 26-22		<b>CIMA 0.3</b> <span style="background-color: #d3d3d3; padding: 2px;">silver plated</span> <b>CIMD 0.3</b> <span style="background-color: #ffd700; padding: 2px;">gold plated</span>
0,33-0,52 mm <sup>2</sup> AWG 22-20		<b>CIMA 0.5</b> <span style="background-color: #d3d3d3; padding: 2px;">silver plated</span> <b>CIMD 0.5</b> <span style="background-color: #ffd700; padding: 2px;">gold plated</span>

- characteristics according to EN 61984:  
**4A 50V 0,8kV 3**  
**4A 160V 2,5kV 2**
- certified (UL for USA and Canada), certified
- insulation resistance:  $\geq 10 \text{ G}\Omega$
- ambient temperature limit:  $-40 \text{ }^\circ\text{C} \dots +125 \text{ }^\circ\text{C}$
- made of self-extinguishing thermoplastic resin UL 94V-0
- mechanical life:  $\geq 500$  cycles
- for crimp contacts CI series use, on page 716 - 719
- CIPZ D** crimping tool
- CITP D** turret head
- CIES** insertion / removal tool
- for max. current load see the connector inserts derating diagram below; for more information see page 28

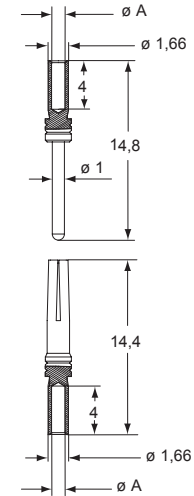
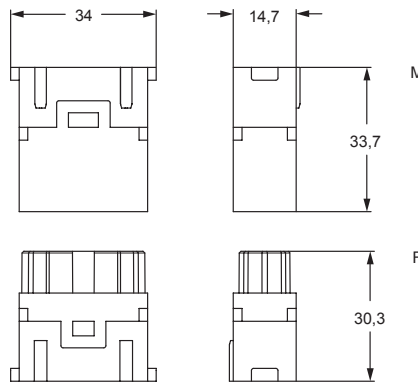

contacts side (front view)

side with reference arrow ▲

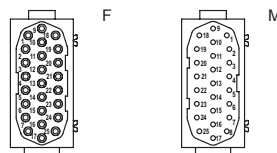

- 1 frame slot

**CX IF/IM 25 poles connector inserts**  
**Maximum current load derating diagram**

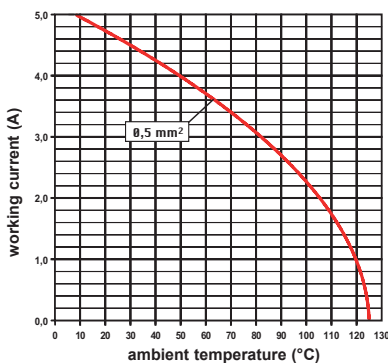

**CIF and CIM contacts**

conductor section (mm <sup>2</sup> )	conductor slot $\phi A$ (mm)	conductors stripping length (mm)
0,08-0,21	0,64	4
0,13-0,33	0,90	4
0,33-0,52	1,12	4

# Gigabit 8 poles 5A - 50V

The modular inserts must be installed in suitable frames which are then mounted in traditional enclosures or in COB panel support.  
Single-sized modular units may be directly mounted inside MIXO ONE enclosures.

frames for modular units page:  
286 - 287

MIXO ONE enclosures 369

- we recommend the use of CRF / CRM code pins together with relevant MIXO frame

## modular units, crimp connections

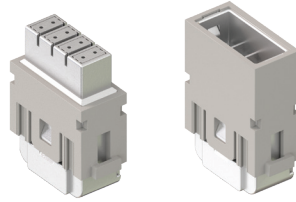

## cable clamp



description

part No.

part No.

without contacts (to be ordered separately)  
female insert for female contacts  
male insert for male contacts

**CX 08 I6F**  
**CX 08 I6M**

cable clamp for 5-7 mm cable diameter  
cable clamp for 7-10 mm cable diameter  
cable clamp for 10-12 mm cable diameter

**CX 5/7 CA**  
**CX 7/10 CA**  
**CX 10/12 CA**

- characteristics according to EN 61984:

- 5A 50V 0,8kV 3**
- insulation resistance:  $\geq 10 \text{ G}\Omega$
- ambient temperature limit:  $-40 \text{ }^\circ\text{C} \dots +85 \text{ }^\circ\text{C}$
- suitable for bus signals, in particular for Ethernet Cat. 6A (Gigabit)
- shield electrically separated from the PE of the housings
- made of self-extinguishing thermoplastic resin UL 94V-0
- mechanical life:  $\geq 500$  cycles
- for crimp contacts CI series use:  
**CIPZ D** crimping tool  
**CITP D** turret head

### CX 08 I6F, CX 08 I6M

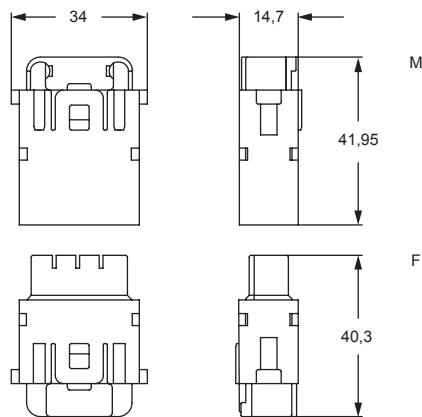

contacts side (front view)

side with reference arrow ▲

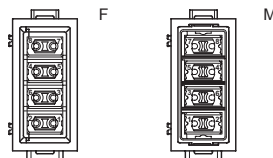

- 1 frame slot

### CX 5/7 CA, CX 7/10 CA, CX 10/12 CA

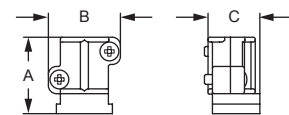

part No.	A	B	C
<b>CX 5/7 CA</b>	19,1	18	12,95
<b>CX 7/10 CA</b>	19,1	18	12,95
<b>CX 10/12 CA</b>	19,1	20,8	12,95



Watch our online tutorial

MIXO DATA

**CI (5A) crimp contacts  
gold plated**



description

part No.

CI (5A) female crimp contacts  
0,08-0,21 mm<sup>2</sup> AWG 28-24  
0,13-0,33 mm<sup>2</sup> AWG 26-22  
0,33-0,52 mm<sup>2</sup> AWG 22-20

**CIFD 0.2**  
**CIFD 0.3**  
**CIFD 0.5**

gold plated

CI (5A) male crimp contacts  
0,08-0,21 mm<sup>2</sup> AWG 28-24  
0,13-0,33 mm<sup>2</sup> AWG 26-22  
0,33-0,52 mm<sup>2</sup> AWG 22-20

**CIMD 0.2**  
**CIMD 0.3**  
**CIMD 0.5**

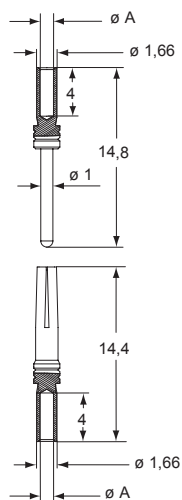

**CIF and CIM contacts**

conductor section (mm <sup>2</sup> )	conductor slot ø A (mm)	conductors stripping length (mm)
0,08-0,21	0,64	4
0,13-0,33	0,90	4
0,33-0,52	1,12	4

# CX 02 BF/BM 2 seats for connector 1 pole + shield

The modular inserts must be installed in suitable frames, which are then mounted in traditional enclosures\* or in COB panel supports.

frames for modular units\*

page: 286

\* enclosures: bulkhead mounting housings, high construction housings or high construction hoods

## seat for shielded connectors

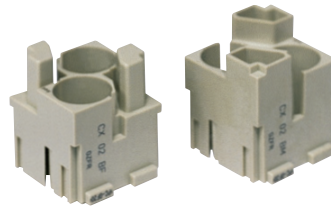

## metal adaptor



description	part No.	part No
-------------	----------	---------

seat for two shielded connectors  
 female insert, two seats for BUS connectors  
 male insert, two seats for BUS connectors  
 metal adaptor (optional)

**CX 02 BF**  
**CX 02 BM**

**CR GND**

- certified
- made of self-extinguishing thermoplastic resin UL 94V-0
- extraction tool for BUS shielded connectors from MIXO BUS insert part No. CX BES see page 703

**Note:**  
 The shielded connectors have their shield insulated from the enclosure's earthing point.  
 If you wish to earth-connect the shield, install on the panel an anchorage for shielded cables CR..ST (see page 678) or the CR GND metal adaptor.

- characteristics according to EN 61984:

**10A 160V 2,5kV 3**  
**10A 250V 4kV 2**

- certified
- rated voltage according to UL/CSA: 600V
- insulation resistance:  $\geq 10 \text{ G}\Omega$
- ambient temperature limit:  $-40 \text{ }^\circ\text{C} \dots +125 \text{ }^\circ\text{C}$
- made of self-extinguishing thermoplastic resin UL 94V-0
- mechanical life:  $\geq 10.000$  cycles
- contact resistance:  $\leq 3 \text{ m}\Omega$
- PCBs interface, refer to article CIF 2.4 on page 670
- **it is recommended to crimp the contacts with crimping tools homologated by ILME** (please see the crimping tool section 10A contacts, RDF2D and RDM2D series) on pages 705 - 741
- for max. current load see the connector inserts derating diagram below; for more information see page 28



contacts side (front view)

side with reference arrow ▲

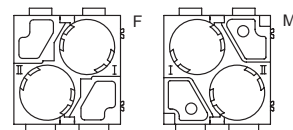

- 2 frame slots

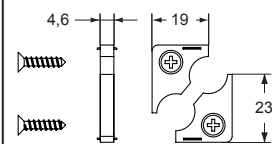

## USE OF THE CR GND METAL ADAPTOR

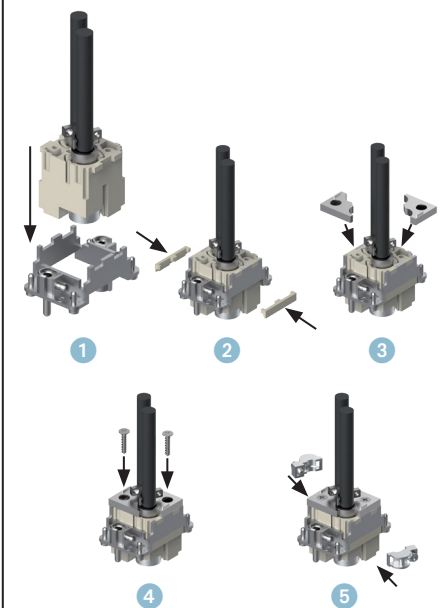

Watch our online tutorial

MIXO DATA

# CX 01 BCF/BCM 1 pole + shield (each connector) 16A - 50V

- characteristics according to EN 61984:  
CX 01 BC shielded connector  
**16A 50V 0,8kV 3**
- certified
- rated voltage according to UL/CSA: 50V
- insulation resistance:  $\geq 10 \text{ G}\Omega$
- ambient temperature limit:  $-40 \text{ }^\circ\text{C} \dots +70 \text{ }^\circ\text{C}$
- contact resistance:  $\leq 1 \text{ m}\Omega$
- mechanical life:  $\geq 500$  cycles
- for information on the crimping of contacts series CC (CX 01 BC shielded connector) and on the insertion/removal tools, see the section related to crimping tools (16A contacts, CCF and CCM series) on pages 705 - 741
- CX 01 BC shielded connector for **cable with a typical impedance of 50  $\Omega$**  (attenuation see below)

## shielded connectors



## 16A crimp contacts, silver and gold plated



description	part No.	part No.
-------------	----------	----------

shielded BUS coaxial connectors, 1 pole + shield female insert, one contact seat 16A (CCF) + shield male insert, one contact seat 16A (CCM) + shield

**CX 01 BCF**  
**CX 01 BCM**

### 16A female crimp contacts

Area	AWG	Characteristics
0,14-0,37 mm <sup>2</sup>	AWG 26-22	one groove
0,5 mm <sup>2</sup>	AWG 20	with no grooves
0,75 mm <sup>2</sup>	AWG 18	one groove (back side)
1 mm <sup>2</sup>	AWG 18	one groove
1,5 mm <sup>2</sup>	AWG 16	two grooves
2,5 mm <sup>2</sup>	AWG 14	three grooves
3 mm <sup>2</sup>	AWG 12	one wide groove
4 mm <sup>2</sup>	AWG 12	with no grooves

### 16A male crimp contacts

Area	AWG	Characteristics
0,14-0,37 mm <sup>2</sup>	AWG 26-22	one groove
0,5 mm <sup>2</sup>	AWG 20	with no grooves
0,75 mm <sup>2</sup>	AWG 18	one groove (back side)
1 mm <sup>2</sup>	AWG 18	one groove
1,5 mm <sup>2</sup>	AWG 16	two grooves
2,5 mm <sup>2</sup>	AWG 14	three grooves
3 mm <sup>2</sup>	AWG 12	one wide groove
4 mm <sup>2</sup>	AWG 12	with no grooves

Part No.	Plating	Part No.	Plating
CCFA 0.3	silver plated	CCFD 0.3	gold plated+
CCFA 0.5		CCFD 0.5	
CCFA 0.7		CCFD 0.7	
CCFA 1.0		CCFD 1.0	
CCFA 1.5		CCFD 1.5	
CCFA 2.5		CCFD 2.5	
CCFA 3.0		CCFD 3.0	
CCFA 4.0	CCFD 4.0		

Part No.	Plating	Part No.	Plating
CCMA 0.3	silver plated	CCMD 0.3	gold plated+
CCMA 0.5		CCMD 0.5	
CCMA 0.7		CCMD 0.7	
CCMA 1.0		CCMD 1.0	
CCMA 1.5		CCMD 1.5	
CCMA 2.5		CCMD 2.5	
CCMA 3.0		CCMD 3.0	
CCMA 4.0	CCMD 4.0		

### CX 01 BCF, CX 01 BCM

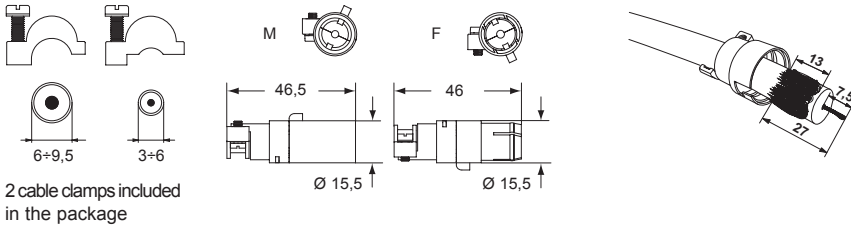

2 cable clamps included in the package

Test performed in accordance with IEC/EN 60512-25-2 (2002), 4.1.3.2 (coaxial cable only) and 4.2.2.2 (coaxial cable and connector).

Attenuation (insertion loss) 50 ohm coaxial connector (CX 01 BCF / BCM)

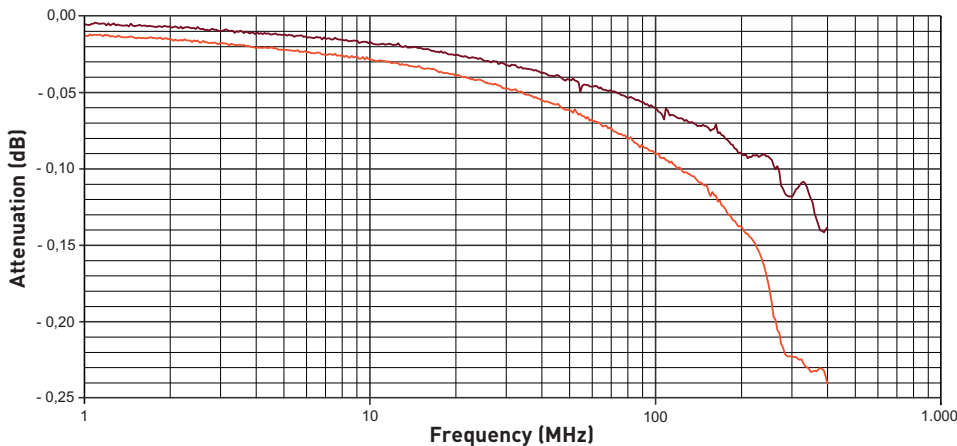

- RG 213/U cable and CX 01 BC connector (50 ohm)
- RG 213/U cable (50 ohm)

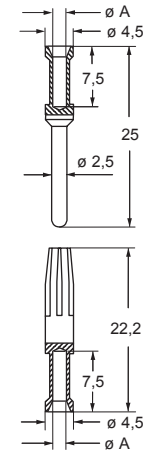

### CCF and CCM contacts

conductor section (mm <sup>2</sup> )	conductor slot $\varnothing A$ (mm)	conductors stripping length (mm)
0,14-0,37	0,9	7,5
0,5	1,1	7,5
0,75	1,3	7,5
1,0	1,45	7,5
1,5	1,8	7,5
2,5	2,2	7,5
3	2,55	7,5
4	2,85	7,5

+ for basic or high thickness gold plating, please refer to page 675

# CX 02 BF/BM 2 seats for connector 1 or 4 poles + shield

The modular inserts must be installed in suitable frames, which are then mounted in traditional enclosures\* or in COB panel supports.

frames for modular units\*

page:  
286

\* enclosures: bulkhead mounting housings, high construction housings or high construction hoods

## seat for shielded connectors

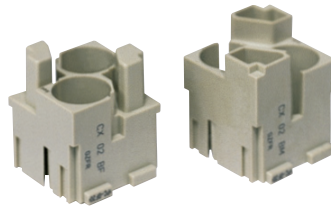

## metal adaptor



description

part No.

part No

seat for two shielded connectors  
female insert, two seats for BUS connectors  
male insert, two seats for BUS connectors  
metal adaptor (optional)

**CX 02 BF**  
**CX 02 BM**

**CR GND**

- certified
- made of self-extinguishing thermoplastic resin UL 94V-0
- extraction tool for BUS shielded connectors from MIXO BUS insert part No. CX BES see page 703

**Note:**  
The shielded connectors have their shield insulated from the enclosure's earthing point.  
If you wish to earth-connect the shield, install on the panel an anchorage for shielded cables CR..ST (see page 678) or the CR GND metal adaptor.

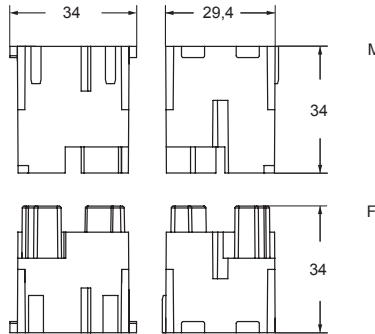

contacts side (front view)

side with reference arrow ▲

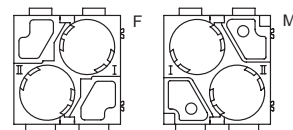

- 2 frame slots

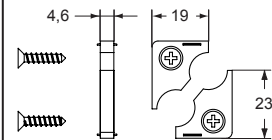

## USE OF THE CR GND METAL ADAPTOR

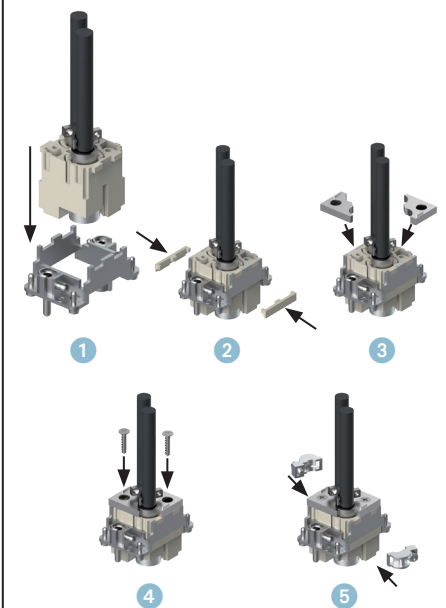

MIXO DATA





- characteristics according to EN 61984:  
CX 04 B / CX 01 B shielded connector  
**10A 50V 0,8kV 3**
- certified
- rated voltage according to UL/CSA: 50V
- insulation resistance:  $\geq 10 \text{ G}\Omega$
- ambient temperature limit:  $-40 \text{ }^\circ\text{C} \dots +70 \text{ }^\circ\text{C}$
- mechanical life:  $\geq 500$  cycles
- contact resistance:  
shielded connector CX 04 B:  $\leq 3 \text{ m}\Omega$   
coaxial connector CX 01 B:  $\leq 3 \text{ m}\Omega$
- for contact crimping instructions, refer to the crimping tool section (10A contacts, CDF and CDM series) on pages 705 - 741
- coaxial connector CX 01 B cables with a typical impedance of  $75 \Omega$  (attenuation see below)
- CX 04 B multi axial connector for STP cables with 2 pairs and terminations compliant with EN 50173-1 Cat. 5 (100 MHz), compatible with 4-wire field bus protocols

**shielded connectors**



**10A crimp contacts, silver and gold plated**



description	part No.	part No.
-------------	----------	----------

shielded BUS coaxial connectors, 1 pole + shield female insert, one contact seat 10A (CDF) + shield male insert, one contact seat 10A (CDM) + shield	<b>CX 01 BF</b> <b>CX 01 BM</b>	
--	------------------------------------	--

shielded BUS multi axial connectors, 4 poles + shield female insert, four contact seats 10A (CDF) + shield male insert, four contact seats 10A (CDM) + shield	<b>CX 04 BF</b> <b>CX 04 BM</b>	
---	------------------------------------	--

**10A female crimp contacts**

0,14-0,37 mm <sup>2</sup>	AWG 26-22	identification No. 1
0,5 mm <sup>2</sup>	AWG 20	identification No. 2
0,75 mm <sup>2</sup>	AWG 18	identification No. ②
1 mm <sup>2</sup>	AWG 18	identification No. 3
1,5 mm <sup>2</sup>	AWG 16	identification No. 4
2,5 mm <sup>2</sup>	AWG 14	identification No. 5

<b>CDFA 0.3</b>
<b>CDFA 0.5</b>
<b>CDFA 0.7</b>
<b>CDFA 1.0</b>
<b>CDFA 1.5</b>
<b>CDFA 2.5</b>

silver plated

<b>CDFD 0.3</b>
<b>CDFD 0.5</b>
<b>CDFD 0.7</b>
<b>CDFD 1.0</b>
<b>CDFD 1.5</b>
<b>CDFD 2.5</b>

gold plated+

**10A male crimp contacts**

0,14-0,37 mm <sup>2</sup>	AWG 26-22	identification No. 1
0,5 mm <sup>2</sup>	AWG 20	identification No. 2
0,75 mm <sup>2</sup>	AWG 18	identification No. ②
1 mm <sup>2</sup>	AWG 18	identification No. 3
1,5 mm <sup>2</sup>	AWG 16	identification No. 4
2,5 mm <sup>2</sup>	AWG 14	identification No. 5

<b>CDMA 0.3</b>
<b>CDMA 0.5</b>
<b>CDMA 0.7</b>
<b>CDMA 1.0</b>
<b>CDMA 1.5</b>
<b>CDMA 2.5</b>

<b>CDMD 0.3</b>
<b>CDMD 0.5</b>
<b>CDMD 0.7</b>
<b>CDMD 1.0</b>
<b>CDMD 1.5</b>
<b>CDMD 2.5</b>

**CX 01 BF, CX 01 BM**

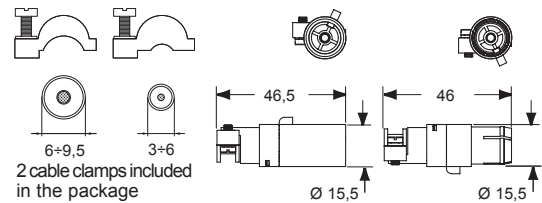

**CX 04 BF, CX 04 BM**

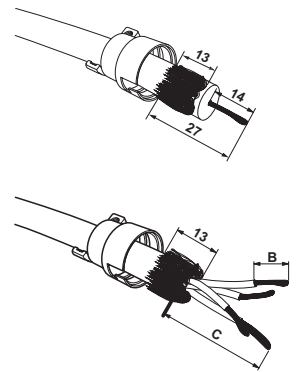
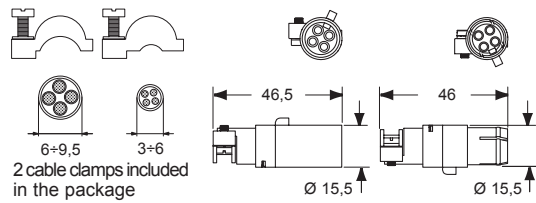

Test performed in accordance with IEC/EN 60512-25-2 (2002), 4.1.3.2 (coaxial cable only) and 4.2.2.2 (coaxial cable and connector).

**Attenuation (insertion loss) 75 ohm coaxial connector (CX 01 BF / BM)**

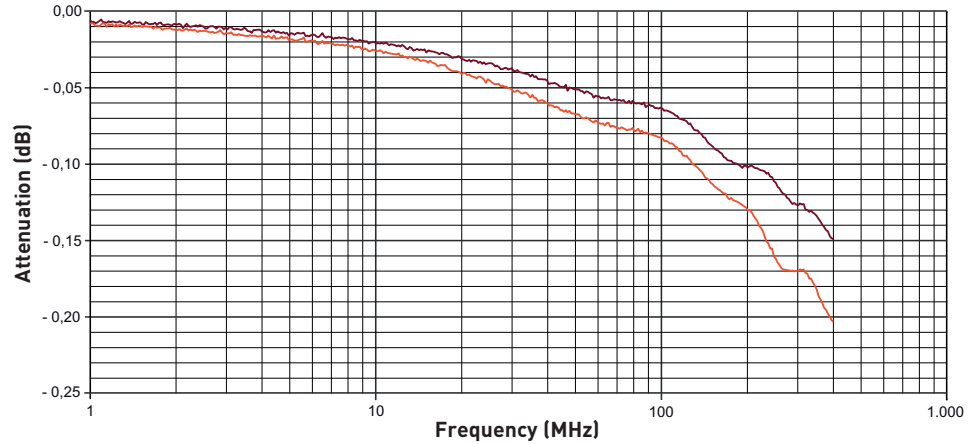

- RG 11 A/U cable and CX 01 B connector (75 ohm)
- RG 11 A/U cable (75 ohm)

cable clamp	C (mm)
3-6	20
6-9,5	25

CDF and CDM contacts		
conductor section	conductor slot	conductors stripping length
(mm <sup>2</sup> )	ø A (mm)	B (mm)
0,14-0,37	0,9	8
0,5	1,1	8
0,75	1,3	8
1,0	1,45	8
1,5	1,8	8
2,5	2,2	6

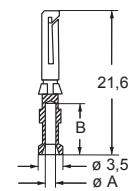

+ for basic or high thickness gold plating, please refer to page 674

# CX 02 BF/BM 2 seats for connector 8 poles + shield

The modular inserts must be installed in suitable frames, which are then mounted in traditional enclosures\* or in COB panel supports.

frames for modular units\*

page:  
286

\* enclosures: bulkhead mounting housings, high construction housings or high construction hoods

## seat for shielded connectors

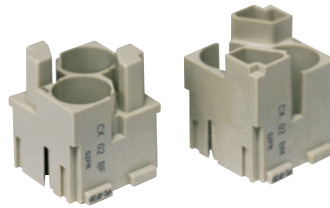

## metal adaptor

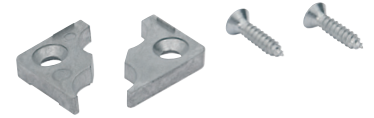

description

part No.

part No

seat for two shielded connectors  
female insert, two seats for BUS connectors  
male insert, two seats for BUS connectors  
metal adaptor (optional)

**CX 02 BF**  
**CX 02 BM**

**CR GND**

- certified
- made of self-extinguishing thermoplastic resin UL 94V-0
- extraction tool for BUS shielded connectors from MIXO BUS insert part No. CX BES see page 703

**Note:**  
The shielded connectors have their shield insulated from the enclosure's earthing point.  
If you wish to earth-connect the shield, install on the panel an anchorage for shielded cables CR..ST (see page 678) or the CR GND metal adaptor.

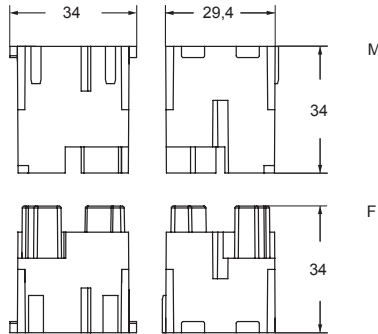

contacts side (front view)

side with reference arrow ▲

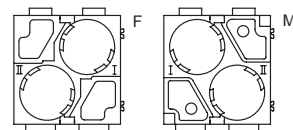

- 2 frame slots

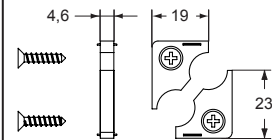

## USE OF THE CR GND METAL ADAPTOR

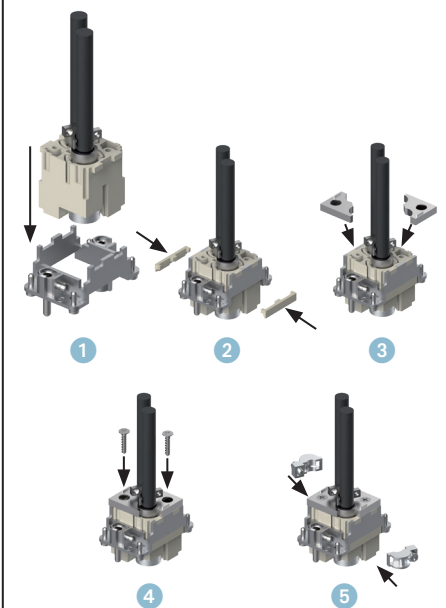

MIXO DATA

# CX 08 BF/BM 8 poles + shield (each connector) 5A - 50V

## shielded connectors



## CI (5A) crimp contacts, silver and gold plated



description	part No.	part No.
-------------	----------	----------

shielded BUS multi axial connectors, 8 poles + shield  
 female insert, eight contact seats 5A (CIF) + shield  
 male insert, eight contact seats 5A (CIM) + shield

**CX 08 BF**  
**CX 08 BM**

**CIFA 0.2**  
**CIFA 0.3**  
**CIFA 0.5**

silver plated

**CIFD 0.2**  
**CIFD 0.3**  
**CIFD 0.5**

gold plated

CI (5A) female crimp contacts  
 0,08-0,21 mm<sup>2</sup> AWG 28-24  
 0,13-0,33 mm<sup>2</sup> AWG 26-22  
 0,33-0,52 mm<sup>2</sup> AWG 22-20

CI (5A) male crimp contacts  
 0,08-0,21 mm<sup>2</sup> AWG 28-24  
 0,13-0,33 mm<sup>2</sup> AWG 26-22  
 0,33-0,52 mm<sup>2</sup> AWG 22-20

- characteristics according to EN 61984:

CX 08 B shielded connector

**5A 50V 0,8kV 3**

- certified
- rated voltage according to UL/CSA: 50V
- insulation resistance: ≥ 10 GΩ
- ambient temperature limit: -40 °C ... +70 °C
- mechanical life: ≥ 500 cycles
- contact resistance: ≤ 4 mΩ
- max. Ø of insulation for contacts CI series: 2,4 mm
- maximum Ø of the insulator: 2,4 mm

- for crimp 5A contacts CI series using:

**CIPZ D** crimping tool

**CITP D** turret head

**CIES** insertion / removal tool

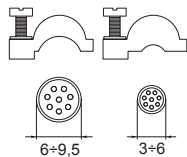

2 cable clamps included in the package

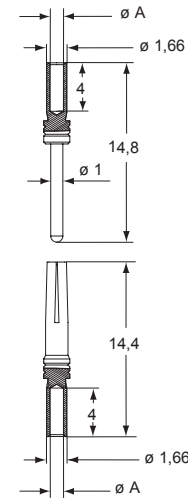
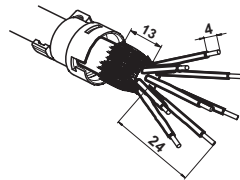
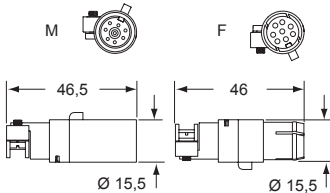

### CIF and CIM contacts

conductor section (mm <sup>2</sup> )	conductor slot ø A (mm)	conductors stripping length (mm)
0,08-0,21	0,64	4
0,13-0,33	0,90	4
0,33-0,52	1,12	4

# CX 01 UF/UM for 1 USB connector

The modular inserts must be installed in suitable frames which are then mounted in traditional enclosures or in COB panel support.  
Single-sized modular units may be directly mounted inside MIXO ONE enclosures.

frames for modular units page: 286 - 287

MIXO ONE enclosures 369

**WARNING**

enclosures: bulkhead mounting housings, high construction housings or high construction hoods

housing for USB male connectors,  
USB female - female connectors

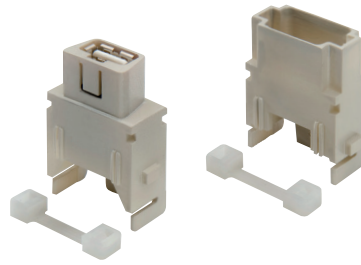

patch cable USB



description

part No.

part No.

female insert with USB female - female connector  
male insert without USB male connector (patch cable to be ordered separately)

**CX 01 UF** <sup>1)</sup>  
**CX 01 UM** <sup>1)</sup>

patch cable USB-A / USB-A, 2 m \*\*

**CW 2 UAM**

\*\* 5 m on request

**USB connector features:**  
- USB-A / USB-A Hi-Speed - 2.0 insert  
- temperature range: from -25 °C to +80 °C

**FIXING**

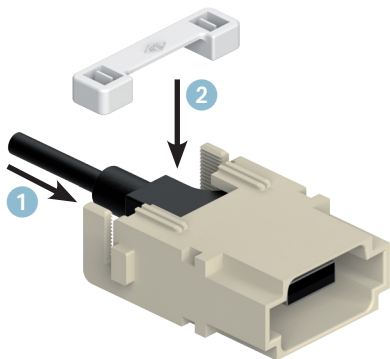

**REOPENING**

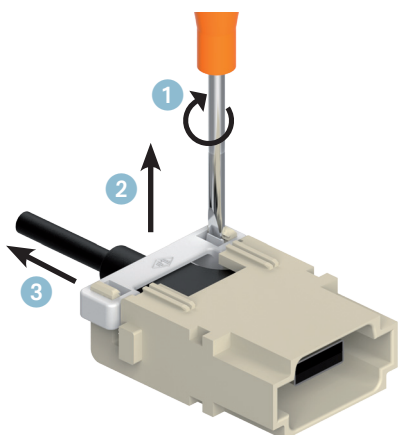

<sup>1)</sup> (UL for USA and Canada), certified

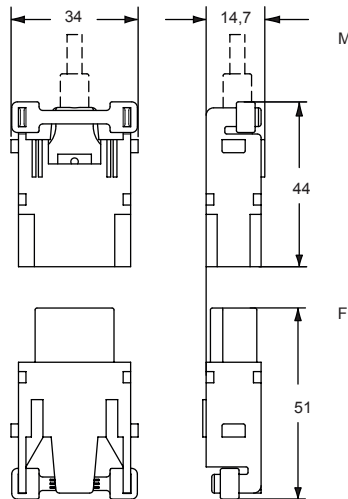

contacts side (front view)

side with reference arrow ▲

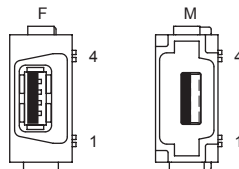

- 1 frame slot

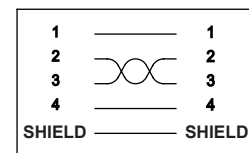
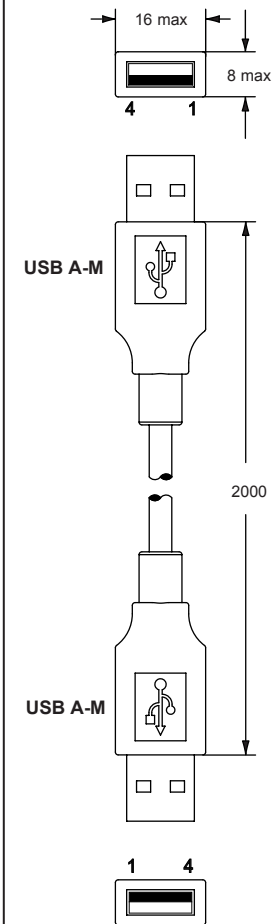

MIXO DATA



MIXO DATA

# CX 01 9VF/9VM for 9-pole crimp D-SUB connector

The modular inserts must be installed in suitable frames which are then mounted in traditional enclosures\* or in COB panel support.  
Single-sized modular units may be directly mounted inside MIXO ONE enclosures.

	page:
frames for modular units*	286 - 287
MIXO ONE enclosures	369

\* enclosures:  
housings or high construction hoods

module adapter for 1 D-SUB connector

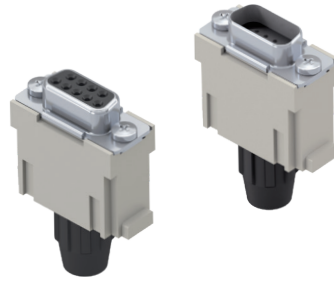

CI (5A) crimp contacts for D-SUB gold plated



description	part No.	part No
-------------	----------	---------

seat for 1 D-SUB crimp contacts connector and shield (included)

female insert with connector	<b>CX 01 9VF</b>
male insert with connector	<b>CX 01 9VM</b>

CI (5A) female crimp contacts  
0.08-0.13 mm<sup>2</sup> AWG 28-26  
0.20-0.52 mm<sup>2</sup> AWG 24-20

**CIVFD 0.1**  
**CIVFD 0.5**

gold plated

CI (5A) male crimp contacts  
0.08-0.13 mm<sup>2</sup> AWG 28-26  
0.20-0.52 mm<sup>2</sup> AWG 24-20

**CIVMD 0.1**  
**CIVMD 0.5**

- characteristics according to EN 61984:

**5A 50V 0,8kV 3**

- for crimp 5A contacts CI series use, on page 717:

**CIPZ D** crimping tool

**CITP D** turret head

**CIVES** insertion / removal tool

**Warnings:**

We recommend the use of code pins  
**CRF CX / CRM CX.**

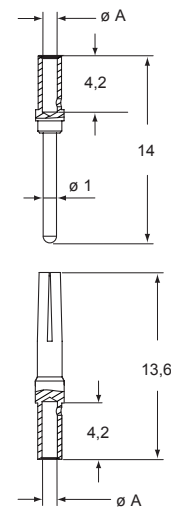
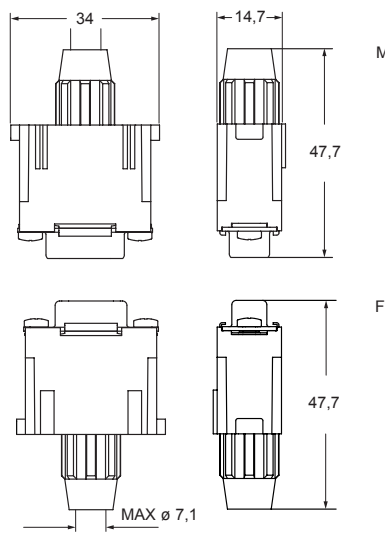

contacts side (front view)

side with reference arrow ▲

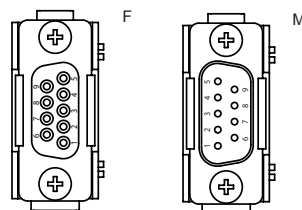

- 1 frame slot

MIXO DATA



## ALTERNATIVELY



- Seats for 1 D-SUB screw connectors (without shield):

**CX 01 9VFS** (with female connectors)  
**CX 01 9VMS** (with male connectors)

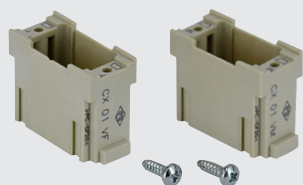

- Seat for 1 D-SUB connector  
 (without connector and shield):

**CX 01 VM** (for male connector)  
**CX 01 VF** (for female connector)

Can also be used with 15-pole D-SUB Hi-Density connectors.  
 For further information, please contact ILME S.p.A.

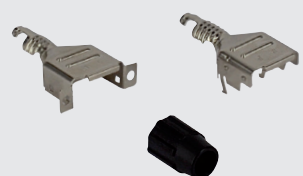

- **CR CX VS** shield  
 for CX 01 VM/VF inserts



- Special version with cable contacts section  
 0,32-0,82 mm<sup>2</sup> AWG 22-18

**CIVFD 0.8** female  
**CIVMD 0.8** male

### 9-POLE FEMALE CRIMP D-SUB CONNECTOR (CAN BE USED WITH CX 01 VF)

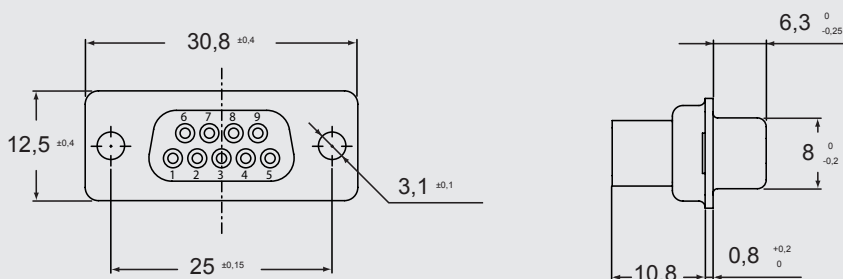

### 9-POLE MALE CRIMP D-SUB CONNECTOR (CAN BE USED WITH CX 01 VM)

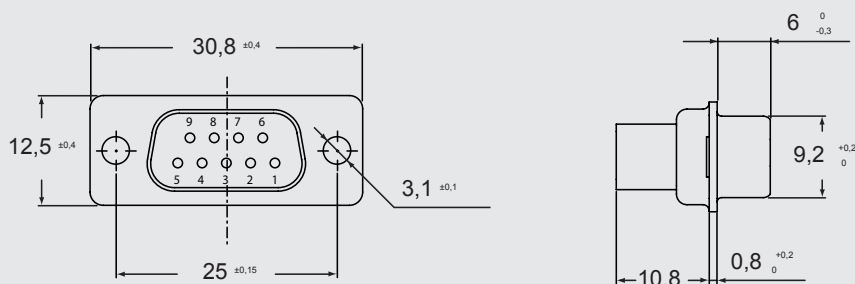

# CX 01 9VTF 9-pole crimp D-SUB RS-485 BUS connector

The modular inserts must be installed in suitable frames which are then mounted in traditional enclosures\* or in COB panel support.  
Single-sized modular units may be directly mounted inside MIXO ONE enclosures.

frames for modular units\* page: 286 - 287

MIXO ONE enclosures 369

\* enclosures: housings or high construction hoods

module adapter for 1 D-SUB RS-485 connector

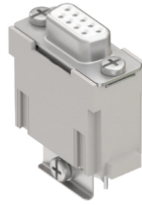

module adapter for 1 D-SUB connector



description

part No.

part No

MIXO D-Sub 9-pole female module for RS-485 T-connection, with cable clamp accommodation for 2 cables

**CX 01 9VTF**

seat for 1 D-SUB crimp contacts connector and shield (included)  
male insert with connector

**CX 01 9VM**

- characteristics according to EN 61984: **5A 50V 0,8kV 3**
- "T" functionality with connection of two RS-485 bus cables (screw terminal)
- to be coupled with CX 01 9VM module
- for wires 0,14-0,5 mm<sup>2</sup> - 26-20 AWG
- cable screen max outer diameter 6 mm

**Warnings:**  
We recommend the use of code pins **CRF CX / CRM CX**.

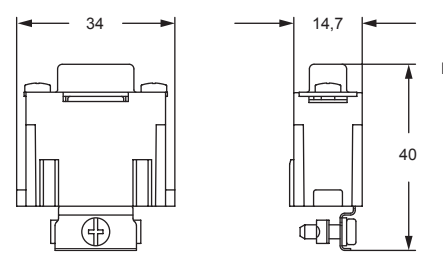

contacts side (front view)

side with reference arrow ▲

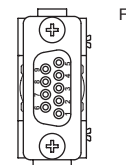

- 1 frame slot

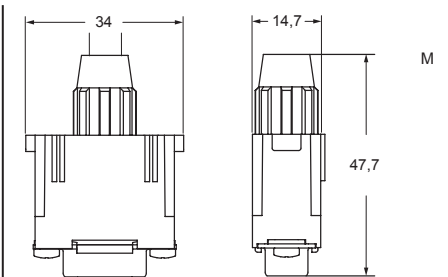

contacts side (front view)

side with reference arrow ▲

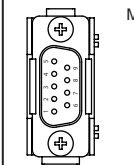

- 1 frame slot



Watch our online tutorial

MIXO DATA

The modular inserts must be installed in suitable frames which are then mounted in traditional enclosures or in COB panel support.  
Single-sized modular units may be directly mounted inside MIXO ONE enclosures.

frames for modular units	page: 286 - 287
MIXO ONE enclosures	369

modular units,  
crimp connections

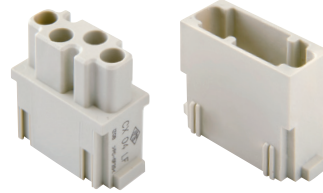

POF / MOST crimp contacts



description	part No.	part No.
without contacts (to be ordered separately)		
female inserts for female contacts	<b>CX 04 LF</b> <sup>1)</sup>	
male inserts for male contacts	<b>CX 04 LM</b> <sup>1)</sup>	
female contacts POF * 1,0 mm		<b>CX PLF</b>
male contacts POF * 1,0 mm		<b>CX PLM</b>
female contacts MOST ** 1/1,5 mm		<b>CX MLF</b>
male contacts MOST ** 1/1,5 mm		<b>CX MLM</b>

\* POF = POLYMER OPTICAL FIBRE  
\*\* MOST = MEDIA ORIENTED SYSTEM TRANSPORT

- ambient temperature limit: -40 °C ... +85 °C
- inserts made of self-extinguishing thermoplastic resin UL 94V-0
- mechanical life: ≥ 500 cycles
- for crimp contacts CI series use:  
**CIPZ D** crimping tool  
**CITP D** turret head
- max external diameter: 2,2 mm (POF)  
2,3 mm (MOST)
- polymer fibre diameter: 1,0 mm (POF)  
1/1,5 mm (MOST)
- attenuation: < 2.5 dB
- to crimp contacts CX PLF / PLM and CX MLF / MLM please use tool CLPZ R (see the crimping tool section on page 730)

We recommend to use CLASS enclosures with two levers or V-TYPE enclosures (with one or two levers) that provides a higher coupling depth due to the higher locking force they produce. We further suggest the use of code pins CRF CX / CRM CX.

<sup>1)</sup> - c us (UL for USA and Canada),   
 EAC certified

**CX 04 LF / LM**

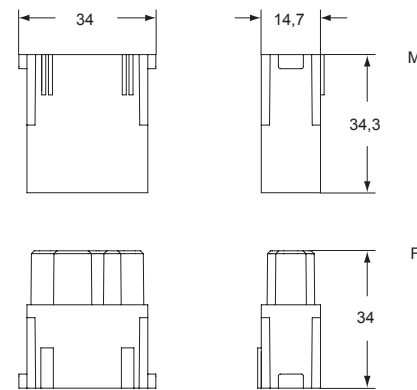

contacts side (front view)

side with reference arrow ▲

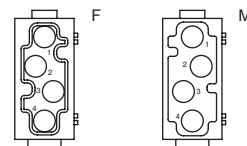

- 1 frame slot

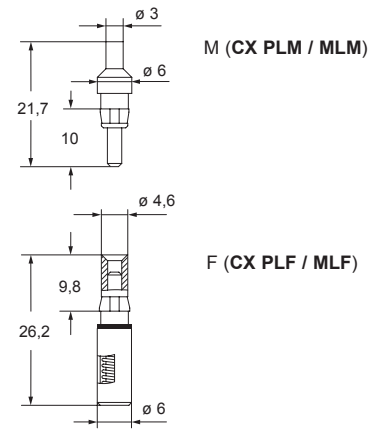

cable stripping for fibre optic

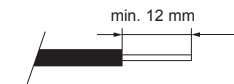

male contact

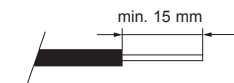

female contact

# for 4 coaxial contacts DIN 41626-T2

The modular inserts must be installed in suitable frames which are then mounted in traditional enclosures or in COB panel support.  
Single-sized modular units may be directly mounted inside MIXO ONE enclosures.

frames for modular units page:  
286 - 287

MIXO ONE enclosures 369

## modular units, crimp connections

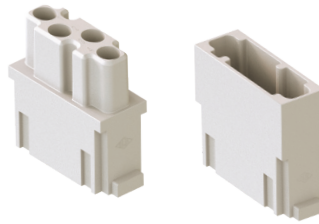

## crimp coaxial contacts



description	part No.	part No.
without contacts (to be ordered separately)		
female inserts for female contacts	<b>CX 04 RF</b>	
male inserts for male contacts	<b>CX 04 RM</b>	
female coaxial contacts 50Ω		<b>CX 50 RF</b>
male coaxial contacts 50Ω		<b>CX 50 RM</b>
female coaxial contacts 75Ω		<b>CX 75 RF</b>
male coaxial contacts 75Ω		<b>CX 75 RM</b>

- certified
- inserts are made of self-extinguishing thermoplastic resin UL 94V-0
- mechanical life: ≥ 500 cycles
- in accordance with standard DIN 41626-T2
- finishing: contact surfaces, body, back end and ferrule gold plated
- impedance: 50 Ω
- frequency: DC to 6 GHz
- return loss: ≥ 21 dB, DC to 2 GHz  
≥ 19 dB, 2 to 6 GHz
- insertion loss: ≤ 0,1 x √f(GHz) dB
- center contact resistance: ≤ 10 mΩ
- outer contact resistance: ≤ 3 mΩ
- test voltage: 750V rms
- working voltage: 250V rms
- RF-leakage: ≥ 80 dB up to 0,5 GHz  
≥ 65 dB up to 1,5 GHz
- to crimp contacts CX 50 RM/RF, CX 75 RM/RF use tool COPZ R (see the crimping tool section on page 734)

**Warnings:**  
We recommend the use of code pins  
**CRF CX / CRM CX.**

### CX 04 RF / RM

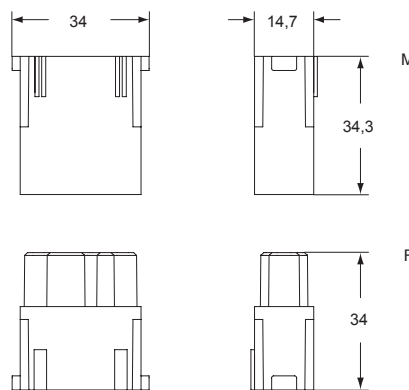

contacts side (front view)

side with reference arrow ▲

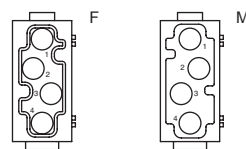

- 1 frame slot

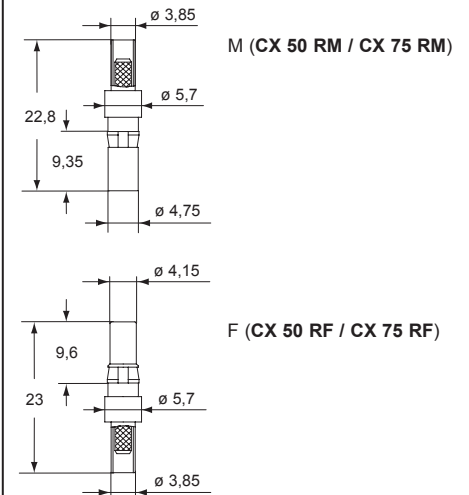

conductor stripping

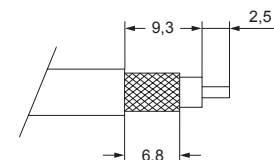

coaxial contacts	for cables	ø external	part No.
50Ω	RG 316/U	2,49 ±0,1	CX 50 RF
	RG 174/U	2,79 ±0,127	CX 50 RM
	RG 188 A/U	2,79 max	
75Ω	RG 179 B/U	2,54 ±0,127	CX 75 RF
	RG 187 A/U	2,79 max	CX 75 RM
	TZC 75 101	2,79 max	

MIXO DATA

# 4 seats for fibre optic SC contacts

The modular inserts must be installed in suitable frames which are then mounted in traditional enclosures or in COB panel support.  
Single-sized modular units may be directly mounted inside MIXO ONE enclosures.

frames for modular units	page: 286 - 287
MIXO ONE enclosures	369

**WARNING:**  
inserts can be used on high enclosures or bulkhead housings only.

## module adaptor for SC connectors

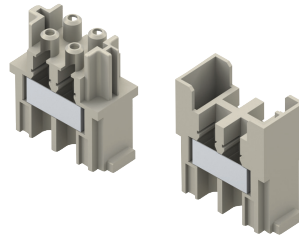

## crimp FO contacts



description	part No.	part No.
module insert with seats for 4 SC contacts (metal fixing plate included) female insert, with ceramic sleeve female insert, with metallic sleeve male insert	<b>CX 04 SCF</b> <b>CX 04 SCF-H</b> <b>CX 04 SCM</b>	<b>CL 125 SC</b> <b>CL POF SC</b>
SC contact for GI FIBRE 50/125 µm or 62.5/125 µm		
SC contact for Ø POF 1 mm		

- certified
- made of self-extinguishing thermoplastic resin UL 94V-0
- mechanical life: ≥ 500 cycles
- temperature range: from -40 °C to +85 °C
- adaptor insert fitted with metal plate and sleeve (female only) fixing

### CX 04 SC

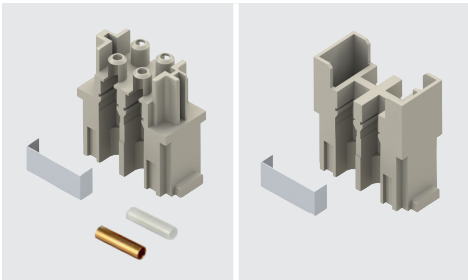

- adaptor insert designed to be used with SC contacts
- SC contact for SI FIBRE (HCS®) 200/230 µm: **CL 230 SC** (on request)
- base equipment for SC contact GI FIBRE: **CLKZ 125 SC**  
If this application is required, please contact ILME S.p.A.
- supplementary set for POF: **CLKZ POF**  
(to be ordered with CLKZ 125 SC)  
If this application is required, please contact ILME S.p.A.

### SC duplex patch cord



CW SC from page 322

### CX 04 SCF, CX 04 SCF-H, CX 04 SCM

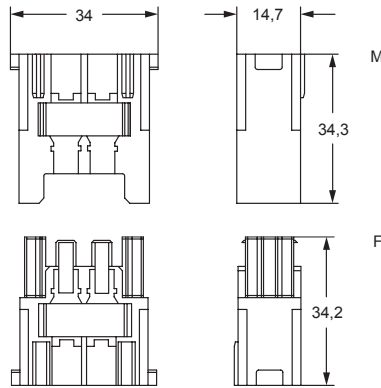

contacts side (front view)

side with reference arrow ▲

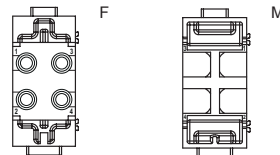

- 1 frame slot

### CL 125 SC

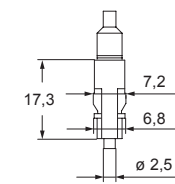



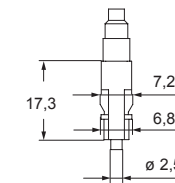

### CL POF SC



# for 1 RJ45 Cat. 6 Class E<sub>A</sub>

The modular inserts must be installed in suitable frames, which are then mounted in traditional enclosures or in COB panel supports.

page: **286 - 287**

- characteristics according to EN 61984: **1A 50V 0,8kV 3**
-   (UL for USA and Canada),  
-  certified
- insulation resistance:  $\geq 10 \text{ G}\Omega$
- made of self-extinguishing thermoplastic resin UL 94V-0
- mechanical life:  $\geq 500$  cycles
- contact resistance:  $\geq 3 \text{ m}\Omega$
- temperature range: from  $-40 \text{ }^\circ\text{C}$  to  $+70 \text{ }^\circ\text{C}$
- we recommend to fix the cable with cable tie
- for contact crimping instructions, please see the crimping tool section on page 736 and 737

housing for RJ45 male connectors, RJ45 female connectors

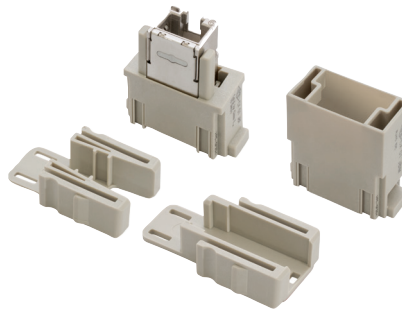

crimp and IDC termination, RJ45 male connectors



description

part No.

part No.

- female insert with 1 RJ45 female connector
- male insert for 1 RJ45 male crimp connector, (without RJ45 connector, to be ordered separately) or connecting cables
- male insert for 1 RJ45 male IDC connector, 8 data contacts (without RJ45 connector, to be ordered separately) \*\*

**CX 01 J8F**  
**CX 01 J8M**  
  
**CX 01 J8IM**

RJ45 male crimp connector, 8 data contacts  
RJ45 male IDC connector, 8 data contacts

**CX 8 J6M**  
**CX 8 J6IM**

**CX 01 J8F technical data:**

- RJ45 female insert, Cat. 6 Class E<sub>A</sub>
- shielding housing: zinc diecast
- housing finish: nickel-plated
- current carrying capacity at 50 °C: 1A
- adequate for Power over Ethernet: PoE according to IEEE 802.3af
- connectors: IEC 60603-7-5
- adequate for 10 Gigabit Ethernet: 10 Gigabit Ethernet acc. to IEEE 802.3an
- custom-designed cabling systems: PROFINET Installation Guideline
- generic cabling systems: ANSI/TIA/EIA-568-C.2 ISO/IEC 11801 EN 50173-1 ISO/IEC 24702 EN 61918
- Class E<sub>A</sub> (channel): ISO/IEC 11801, EN 50173-1

\*\* CX 01 J8IM: to be used with high enclosures (T-TYPE hood M32 / M40 only and CZAV/MZAV top entry hood only), bulkhead housings or COB ... BC/TCQ/TSF/ TSFS only.

**CX 01 J8F**

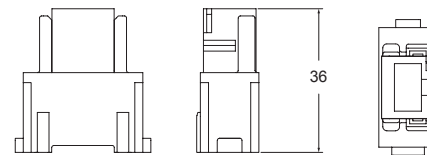

**CX 01 J8M**

can be used with connecting cables CW series (RJ45 and M12x1)

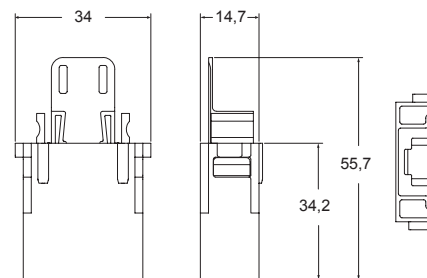

**CX 01 J8IM**

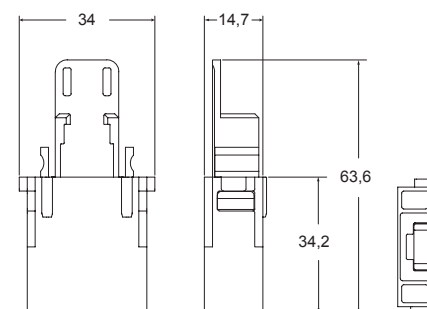

**CX 8 J6M**

can be used with CX 01 J8M

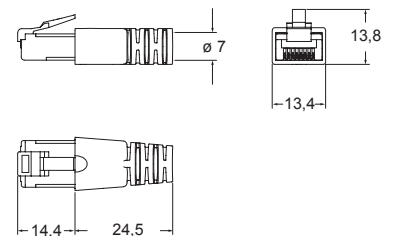

for free cable end X-coded DTW X...W (M12x1)

**CX 8 J6IM**

can be used with CX 01 J8IM

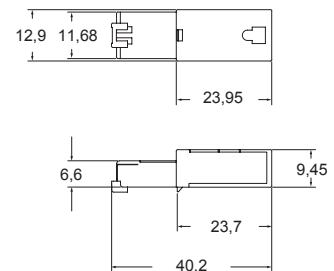

for free cable end X-coded DTW...W (M12x1)

**CX 8 J6M technical data:**

- RJ45 male crimp connectors Cat. 6<sub>A</sub>
- crimp pliers: **CJPZ T**
- screened cable stripper: **CJST**
- Cu-conductor diameter solid: 0,40 - 0,51 mm (AWG 26/1 - 24/1) stranded: 0,46 - 0,61 mm (AWG 27/7 - 24/7)
- insulation diameter: 0,85 - 1,05 mm
- cable diameter: 5,0 - 6,6 mm
- connectors: IEC 60603-7-51
- 10 Gigabit Ethernet acc. to IEEE 802.3an: adequate for 10 Gigabit Ethernet
- category 6<sub>A</sub>: ISO/IEC 11801; EN 50173-1
- Class E<sub>A</sub>: ISO/IEC 11801; EN 50173-1
- Category 6<sub>A</sub>: ANSI/TIA/EIA-568-C.2

**CX 8 J6IM technical data:**

- RJ45 male IDC connectors Cat. 6 Class E<sub>A</sub>
- Cu-conductor diameter solid: 0,41 - 0,64 mm (AWG 26/1 - 22/1) stranded: 0,48 - 0,76 mm (AWG 26/7 - 22/7)
- insulation diameter: 0,85 - 1,6 mm
- cable diameter: 5,5 - 7,3 mm
- connectors: IEC 60603-7-5
- category 6<sub>A</sub>: ISO/IEC 11801; DIN EN 50173-1
- wrenches pliers for CX 8 J6IM: **CJPW K**
- 10 Gigabit Ethernet acc. to IEEE 802.3an: adequate for 10 Gigabit Ethernet
- Class E<sub>A</sub>: ISO/IEC 11801; EN 50173-1
- Category 6: ANSI/TIA/EIA-568-C.2
- custom-designed cabling systems: according to PROFINET Installation Guideline

**WARNING:**

inserts can be used on high enclosures or bulkhead housings only.

MIXO DATA





# for 1 RJ45 + 4 poles connector 10A - 250V

The modular inserts must be installed in suitable frames, which are then mounted in traditional enclosures or in COB panel supports.

frames for modular units

page:  
286

- characteristics according to EN 61984:

**10A 250V 4kV 3**

- CE mark (UL for USA and Canada),    

-   certified

- insulation resistance:  $\geq 10 \text{ G}\Omega$

- made of self-extinguishing thermoplastic resin UL 94V-0

- mechanical life:  $\geq 500$  cycles

- contact resistance:  $\geq 3 \text{ m}\Omega$

- **it is recommended to crimp the contacts with crimping tools homologated by ILME** (please see the crimping tool section 10A contacts, CDF and CDM series) on pages 705 - 741

## housing for RJ45 connectors

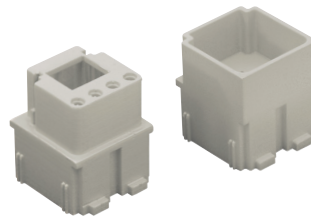

## RJ45 connectors

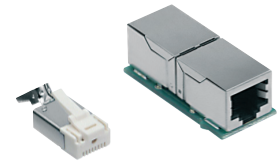

description

part No.

part No.  
data contacts only

part No.  
data contacts/+2 power contacts

without RJ45 connector and without contacts  
(to be ordered separately)

- female inserts for 1 RJ45 female connector  
and for 4 10A (CDF) female contacts  
- male inserts for 1 RJ45 male connector  
and for 4 10A (CDM) male contacts

**CX 01 JF \*\***

**CX 01 JM**

RJ45 coupler jack, 8 data contacts

RJ45 coupler jack, 8 data contacts / 2 power contacts

**CX 8 JF \***

**CX 8/2 JF \***

RJ45 plug, 4 data contacts

RJ45 plug, 4 data contacts / 2 power contacts

RJ45 plug, 6 data contacts / 2 power contacts

RJ45 plug, 8 data contacts **Cat. 5e**

RJ45 plug, 4 data contacts **Cat. 5e ProfiNET®**

**CX 4 JM**

**CX 4/2 JM**

**CX 6/2 JM**

**CX 8 JM**

**CX 4E JM**

### RJ45 connector features:

- RJ45 insert, **Cat. 5 Ethernet**

- rated current: 2,1A at 70 °C

- rated voltage: 50VDC / 35VAC

- IDC terminals:

for 0,22 mm<sup>2</sup> (AWG 24/7) data contacts **CX 4 JM**

for 0,14 mm<sup>2</sup> (AWG 26/7) or 0,22 mm<sup>2</sup> (AWG 24/7) data contacts **CX 4/2 JM**

for 0,34 mm<sup>2</sup> (AWG 22/7) or 0,38 mm<sup>2</sup> (AWG 22/19) power contacts **CX 4/2 JM**

for 0,14 mm<sup>2</sup> (AWG 26/7) data contacts **CX 6/2 JM**

for 0,25 mm<sup>2</sup> (AWG 23/19) power contacts **CX 6/2 JM**

for 0,14 mm<sup>2</sup> (AWG 26/7) data contacts **CX 8 JM**

for 0,34 mm<sup>2</sup> (AWG 22/7) data contacts **CX 4E JM**

- /7 = 7-strands wire

- /19 = 19-strands wire

- insulation diameter: 1 mm (data), 1,4 mm (power and CX 4E JM)

-  $\varnothing_{\text{max}}$  complete cable 7 mm (CX 8 JM: 6,9 mm)

- temperature range: from -40°C to 120 °C

- nickel plated brass screening

- crimp pliers: **CJPZ Y**

- screened cable stripper: **CJST**

### \*\* WARNING:

the female inserts can only be used on high or flush mounting enclosures

### CX 01 JF, CX 01 JM

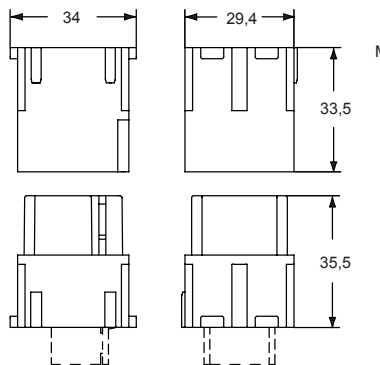

contacts side (front view)

side with reference arrow ▲

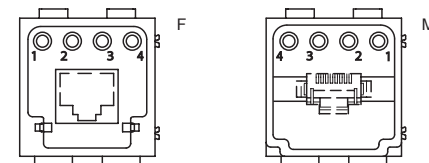

- 2 frame slots

\* 4-pole version on request, part No. **CX 4 JF** and **CX 4/2 JF** with "crossover" link

### CX 4 JF, CX 4/2 JF, CX 8 JF, CX 8/2 JF

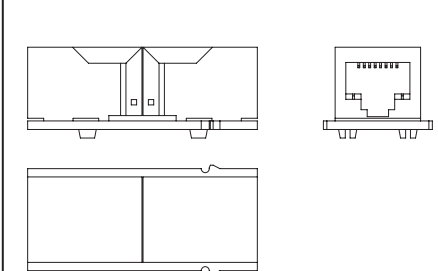

### CX 4 JM, CX 4/2 JM, CX 6/2 JM, CX 8 JM, CX 4E JM

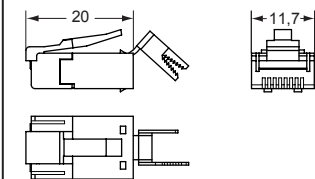

### CW patch cord RJ45

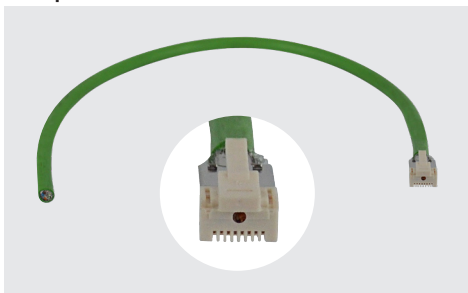

CW JM from page 278

MIXO DATA

### 10A crimp contacts, silver and gold plated



description			part No.	
<b>10A female crimp contacts</b>				
0,14-0,37 mm <sup>2</sup>	AWG 26-22	identification No. 1	<b>CDFA 0.3</b>	<b>CDFD 0.3</b>
0,5 mm <sup>2</sup>	AWG 20	identification No. 2	<b>CDFA 0.5</b>	<b>CDFD 0.5</b>
0,75 mm <sup>2</sup>	AWG 18	identification No. ②	<b>CDFA 0.7</b>	<b>CDFD 0.7</b>
1 mm <sup>2</sup>	AWG 18	identification No. 3	<b>CDFA 1.0</b>	<b>CDFD 1.0</b>
1,5 mm <sup>2</sup>	AWG 16	identification No. 4	<b>CDFA 1.5</b>	<b>CDFD 1.5</b>
2,5 mm <sup>2</sup>	AWG 14	identification No. 5	<b>CDFA 2.5</b>	<b>CDFD 2.5</b>
<b>10A male crimp contacts</b>				
0,14-0,37 mm <sup>2</sup>	AWG 26-22	identification No. 1	<b>CDMA 0.3</b>	<b>CDMD 0.3</b>
0,5 mm <sup>2</sup>	AWG 20	identification No. 2	<b>CDMA 0.5</b>	<b>CDMD 0.5</b>
0,75 mm <sup>2</sup>	AWG 18	identification No. ②	<b>CDMA 0.7</b>	<b>CDMD 0.7</b>
1 mm <sup>2</sup>	AWG 18	identification No. 3	<b>CDMA 1.0</b>	<b>CDMD 1.0</b>
1,5 mm <sup>2</sup>	AWG 16	identification No. 4	<b>CDMA 1.5</b>	<b>CDMD 1.5</b>
2,5 mm <sup>2</sup>	AWG 14	identification No. 5	<b>CDMA 2.5</b>	<b>CDMD 2.5</b>

silver plated

gold plated+

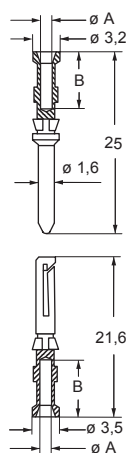

#### CDF and CDM contacts

conductor section (mm <sup>2</sup> )	conductor slot $\varnothing A$ (mm)	conductors stripping length B (mm)
0,14-0,37	0,9	8
0,5	1,1	8
0,75	1,3	8
1,0	1,45	8
1,5	1,8	8
2,5	2,2	6





+ for basic or high thickness gold plating, please refer to page 674

# for 2 RJ45 + 8 poles connector 10A - 250V

The modular inserts must be installed in suitable frames, which are then mounted in traditional enclosures or in COB panel supports.

page: 286

frames for modular units

- characteristics according to EN 61984:
- 10A 250V 4kV 3**
- cULus (UL for USA and Canada),   
-  certified
- insulation resistance:  $\geq 10 \text{ G}\Omega$
- made of self-extinguishing thermoplastic resin UL 94V-0
- mechanical life:  $\geq 500$  cycles
- contact resistance:  $\geq 3 \text{ m}\Omega$
- **it is recommended to crimp the contacts with crimping tools homologated by ILME** (please see the crimping tool section 10A contacts, CDF and CDM series) on pages 705 - 741

housing for RJ45 connectors

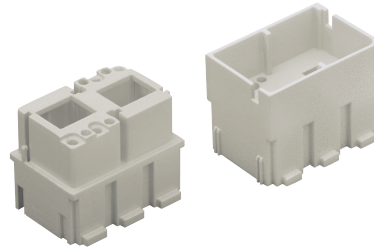

RJ45 connectors

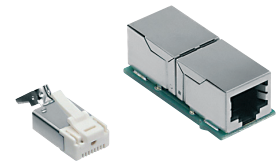

description	part No.	part No. data contacts only	part No. data contacts/+2 power contacts
without RJ45 connector and without contacts (to be ordered separately)			
- female insert for 2 RJ45 female connectors and for 8 10A (CDF) female contacts	<b>CX 02 JF **</b>		
- male insert for 2 RJ45 male connectors and for 8 10A (CDM) male contacts	<b>CX 02 JM</b>		
RJ45 coupler jack, 8 data contacts		<b>CX 8 JF *</b>	
RJ45 coupler jack, 8 data contacts / 2 power contacts			<b>CX 8/2 JF *</b>
RJ45 plug, 4 data contacts		<b>CX 4 JM</b>	
RJ45 plug, 4 data contacts / 2 power contacts			<b>CX 4/2 JM</b>
RJ45 plug, 6 data contacts / 2 power contacts			<b>CX 6/2 JM</b>
RJ45 plug, 8 data contacts <b>Cat. 5e</b>		<b>CX 8 JM</b>	
RJ45 plug, 4 data contacts <b>Cat. 5e ProfINET®</b>		<b>CX 4E JM</b>	

**RJ45 connector features:**

- RJ45 insert, **Cat. 5 Ethernet**
- rated current: 2,1A at 70 °C
- rated voltage: 50VDC / 35VAC
- IDC terminals:
- for 0,22 mm<sup>2</sup> (AWG 24/7) data contacts **CX 4 JM**
- for 0,14 mm<sup>2</sup> (AWG 26/7) or 0,22 mm<sup>2</sup> (AWG 24/7) data contacts **CX 4/2 JM**
- for 0,34 mm<sup>2</sup> (AWG 22/7) or 0,38 mm<sup>2</sup> (AWG 22/19) power contacts **CX 4/2 JM**
- for 0,14 mm<sup>2</sup> (AWG 26/7) data contacts **CX 6/2 JM**
- for 0,25 mm<sup>2</sup> (AWG 23/19) power contacts **CX 6/2 JM**
- for 0,14 mm<sup>2</sup> (AWG 26/7) data contacts **CX 8 JM**
- for 0,34 mm<sup>2</sup> (AWG 22/7) data contacts **CX 4E JM**
- /7 = 7-strands wire
- /19 = 19-strands wire
- insulation diameter: 1 mm (data), 1,4 mm (power and CX 4E JM)
- $\varnothing_{\text{max}}$  complete cable 7 mm (CX 8 JM: 6,9 mm)
- temperature range: from -40°C to 120 °C
- nickel plated brass screening
- crimp pliers: **CJPZ Y**
- screened cable stripper: **CJST**

**\*\* WARNING:**

the female inserts can only be used on high or flush mounting enclosures

**CX 02 JF, CX 02 JM**

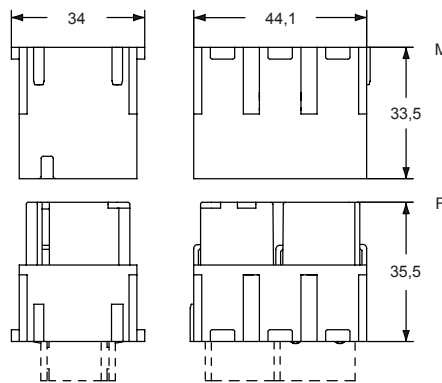

contacts side (front view)

side with reference arrow ▲

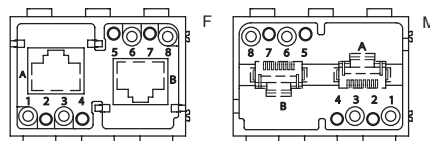

- 3 frame slots

\* 4-pole version on request, part No. **CX 4 JF** and **CX 4/2 JF** with "crossover" link

**CX 4 JF, CX 4/2 JF, CX 8 JF, CX 8/2 JF**

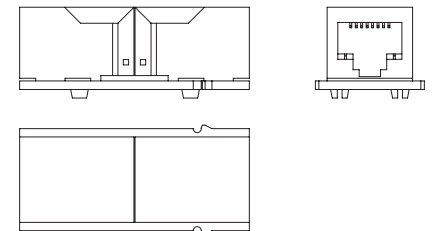

**CX 4 JM, CX 4/2 JM, CX 6/2 JM, CX 8 JM, CX 4E JM**

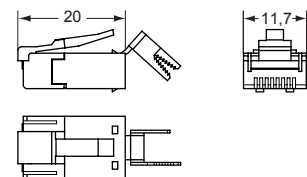

**CW patch cord RJ45**

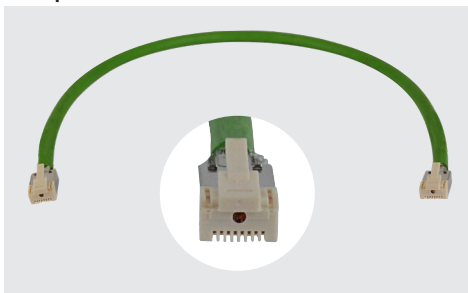

CW J2M from page 278

MIXO DATA

### 10A crimp contacts, silver and gold plated



description			part No.	
<b>10A female crimp contacts</b>				
0,14-0,37 mm <sup>2</sup>	AWG 26-22	identification No. 1	<b>CDFA 0.3</b>	<b>CDFD 0.3</b>
0,5 mm <sup>2</sup>	AWG 20	identification No. 2	<b>CDFA 0.5</b>	<b>CDFD 0.5</b>
0,75 mm <sup>2</sup>	AWG 18	identification No. ②	<b>CDFA 0.7</b>	<b>CDFD 0.7</b>
1 mm <sup>2</sup>	AWG 18	identification No. 3	<b>CDFA 1.0</b>	<b>CDFD 1.0</b>
1,5 mm <sup>2</sup>	AWG 16	identification No. 4	<b>CDFA 1.5</b>	<b>CDFD 1.5</b>
2,5 mm <sup>2</sup>	AWG 14	identification No. 5	<b>CDFA 2.5</b>	<b>CDFD 2.5</b>
<b>10A male crimp contacts</b>				
0,14-0,37 mm <sup>2</sup>	AWG 26-22	identification No. 1	<b>CDMA 0.3</b>	<b>CDMD 0.3</b>
0,5 mm <sup>2</sup>	AWG 20	identification No. 2	<b>CDMA 0.5</b>	<b>CDMD 0.5</b>
0,75 mm <sup>2</sup>	AWG 18	identification No. ②	<b>CDMA 0.7</b>	<b>CDMD 0.7</b>
1 mm <sup>2</sup>	AWG 18	identification No. 3	<b>CDMA 1.0</b>	<b>CDMD 1.0</b>
1,5 mm <sup>2</sup>	AWG 16	identification No. 4	<b>CDMA 1.5</b>	<b>CDMD 1.5</b>
2,5 mm <sup>2</sup>	AWG 14	identification No. 5	<b>CDMA 2.5</b>	<b>CDMD 2.5</b>

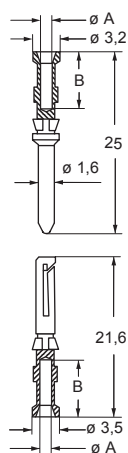

#### CDF and CDM contacts

conductor section (mm <sup>2</sup> )	conductor slot $\varnothing A$ (mm)	conductors stripping length B (mm)
0,14-0,37	0,9	8
0,5	1,1	8
0,75	1,3	8
1,0	1,45	8
1,5	1,8	8
2,5	2,2	6

‡ for basic or high thickness gold plating, please refer to page 674

# CW patch cord RJ45

with 1 RJ45 male connector

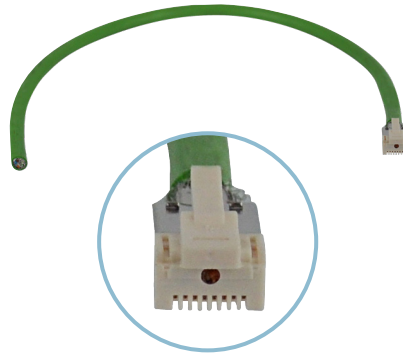

with 2 RJ45 male connectors

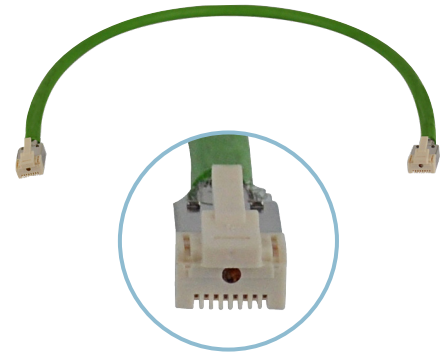

MIXO DATA

description	part No.	(L) metre	part No.	(L) metre
RJ45 male connector with 4 data contacts / 2 power contacts	CW 0.5 JM4/2	0.5		
	CW 2 JM4/2	2		
	CW 5 JM4/2	5		
	CW 10 JM4/2	10		
RJ45 male connector with 8 data contacts	CW 0.5 JM	0.5	CW 0.5 J2M8	0.5
	CW 2 JM8	2	CW 2 J2M8	2
	CW 5 JM8	5	CW 5 J2M8	5
	CW 10 JM8	10	CW 10 J2M8	10
RJ45 male connector with 4 data contacts, <b>Cat. 5e</b>	CW 0.5 JM4E	0.5	CW 0.5 J2M4E	0.5
	CW 2 JM4E	2	CW 2 J2M4E	2
	CW 5 JM4E	5	CW 5 J2M4E	5
	CW 10 JM4E	10	CW 10 J2M4E	10

**RJ45 connector features:**

- insert RJ45, Cat. 5 Ethernet
- nominal current: 2,1A at 70 °C
- nominal voltage: 50V DC / 35V AC
- temperature range: from -40 °C to +120 °C
- nickel plated brass screening

**Can be used with:**

- MIXO RJ45: CX 01 JM and CX 02 JM male inserts  
see pages 274 and 276

CW JM 4/2, 8, 4E and CW J2M 4/2, 8, 4E

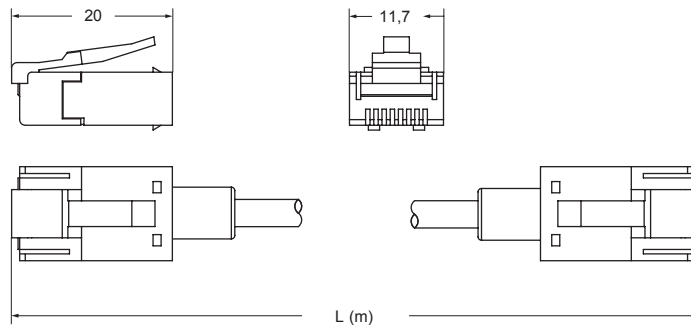

**Wiring Diagram**

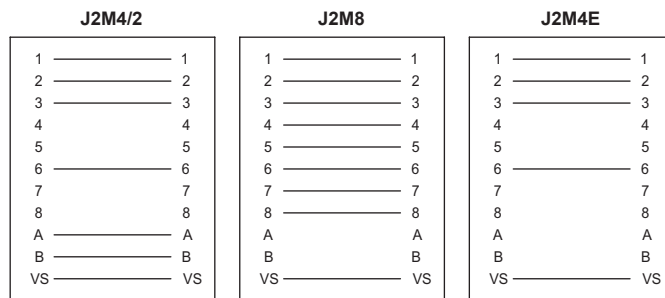



# CX FM

The modular inserts must be installed in suitable frames, which are then mounted in traditional enclosures or in COB panel supports.  
 Alternatively, individual modules with a width of 14,7 mm can be installed in plastic supports.

frames for modular units

page:  
 286

## dummy module

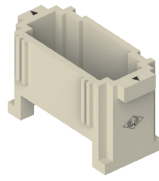

description

part No.

dummy module for unused frame seats

CX FM

**Remark:**  
 The new version is formed by a single piece and has a reduced height.  
 It allows the mating of a MIXO insert including it with a corresponding MIXO insert even having - in front of the dummy module - a regular male or female module equipped with contacts, which obviously will not work.  
 The sole exceptions to this feature are that an insert with this dummy module cannot mate an insert showing in front a CX 3/4 XDF/M, CX 04 XF/M or CX 02 HF module.

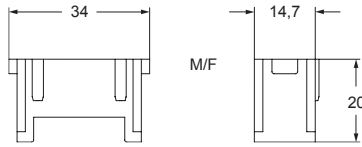

- 1 frame slot

MIXO units

MIXO a-f frame for housings

Enclosures

RJ45 MIXO CONNECTOR Cat 6<sup>A</sup>

RJ45 female/female coupler



CX 01 J8F

RJ45 MIXO CONNECTOR Cat 5-5e

1x RJ45 female/female coupler  
+ 4x 10A crimp contacts

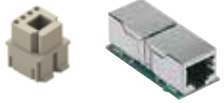

CX 01 JF+ CX 8 JF  
or  
CX 8/2 JF

2x RJ45 female/female coupler  
+ 8x 10A crimp contacts



CX 02 JF + 2x CX 8 JF  
or  
2x CX 8/2 JF

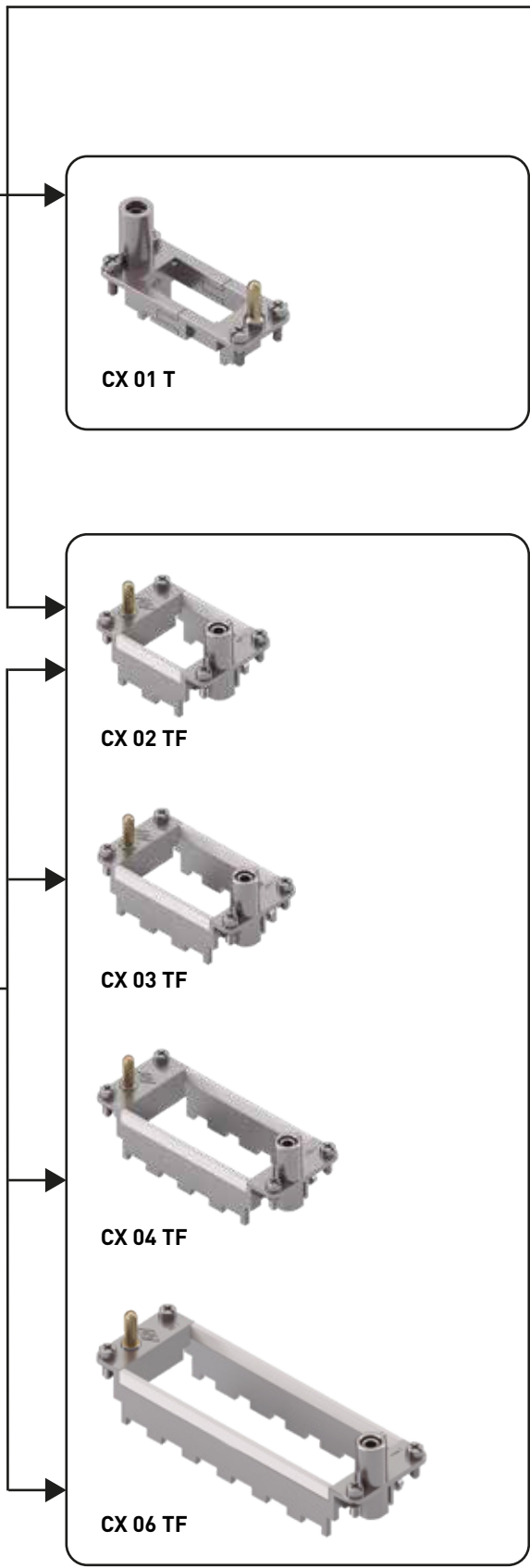

MIXO ONE

CX 01 T

CZ IL-BRID

CX 02 TF

C-TYPE  
C7 IP68

CX 03 TF

V-TYPE  
T-TYPE

CX 04 TF

W-TYPE  
EMC

CX 06 TF

LS-TYPE  
COB  
IP68  
Central lever  
BIG

## Enclosures

## MIXO A-F frame for hoods

## MIXO units

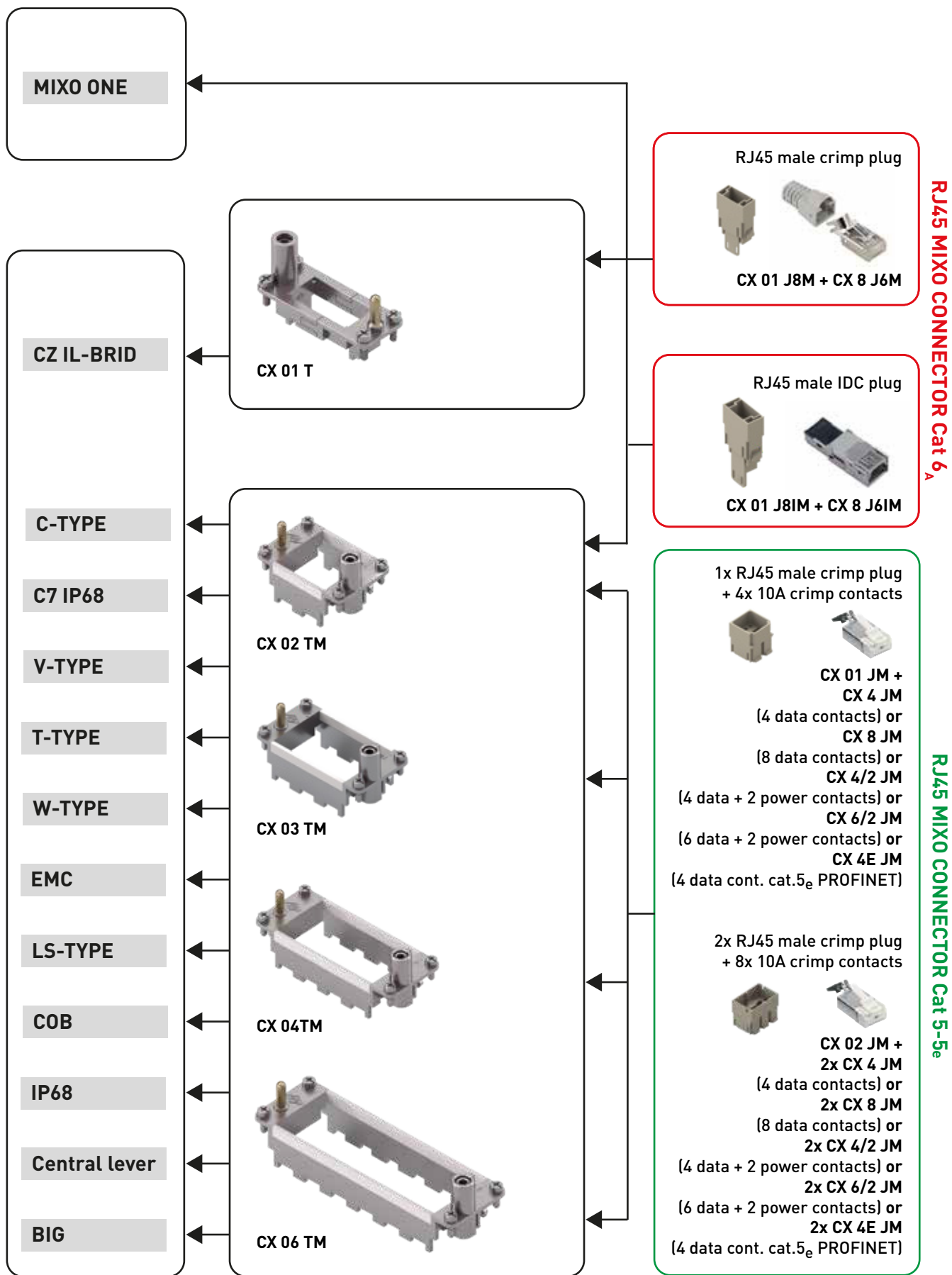

# CX 03 P - CX 02 P for pneumatic contacts

The modular inserts must be installed in suitable frames which are then mounted in traditional enclosures or in COB panel support.  
Single-sized modular units may be directly mounted inside MIXO ONE enclosures.

frames for modular units	page: 286 - 287
MIXO ONE enclosures	369

## modular units with 3 seats

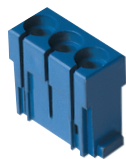

## modular units with 2 seats



description

part No.

part No.

without contacts (to be ordered separately)  
inserts with 3 housings for tube Ø 1,6 - 4,0

**CX 03 P**

without contacts (to be ordered separately)  
inserts with 2 housings for tube Ø 6,0

**CX 02 P**

- certified
- made of self-extinguishing thermoplastic resin UL 94V-0
- mechanical life: ≥ 500 cycles

### Use of units for pneumatic contacts

- identical male and female modular units
- pneumatic contacts for pressure values up to 8 bar, for use with clean and dry compressed air
- use of tubes with Ø 1,6 - 3 - 4 and 6 mm, and possible replacement of tubes with assembled units
- possibility of using tubes with different diameters in the same modular unit
- female contacts with or without closing valve
- working temperature range - 40 °C ÷ + 80 °C

### Warnings:

CRM/F CX code pins and guides must be used for pneumatic contacts modules.  
These pins also provide coding if pneumatic contacts modules are used exclusively.

The use of pneumatic contacts requires an appropriate filtering and dehydration system to prevent dangerous condensation.  
Contacts may be used for pressure values of up to a maximum of 8 bars/116 psi.

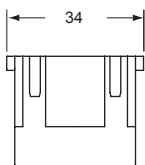

M/F

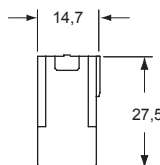

contacts side (front view)

side with reference arrow ▲

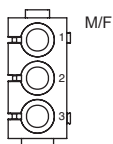

- 1 frame slot

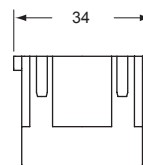

M/F

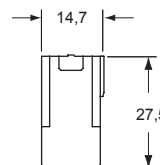

contacts side (front view)

side with reference arrow ▲

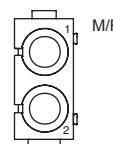

- 1 frame slot

**pneumatic contacts  
with or without closing valve**



description	part No.
female contacts without closing valve	
- for tubes with internal $\varnothing$ 1,6 mm	<b>CX 1.6 PF</b>
- for tubes with internal $\varnothing$ 3 mm	<b>CX 3.0 PF</b>
- for tubes with internal $\varnothing$ 4 mm	<b>CX 4.0 PF</b>
- for tubes with internal $\varnothing$ 6 mm	<b>CX 6.0 PF</b>
male contacts without closing valve	
- for tubes with internal $\varnothing$ 1,6 mm	<b>CX 1.6 PM</b>
- for tubes with internal $\varnothing$ 3 mm	<b>CX 3.0 PM</b>
- for tubes with internal $\varnothing$ 4 mm	<b>CX 4.0 PM</b>
- for tubes with internal $\varnothing$ 6 mm	<b>CX 6.0 PM</b>
female contacts with closing valve	
- for tubes with internal $\varnothing$ 1,6 mm	<b>CX 1.6 VC</b>
- for tubes with internal $\varnothing$ 3 mm	<b>CX 3.0 VC</b>
- for tubes with internal $\varnothing$ 4 mm	<b>CX 4.0 VC</b>
- for tubes with internal $\varnothing$ 6 mm	<b>CX 6.0 VC</b>
male contact (use contacts without closing valve)	

**CX 1.6 PF/PM/VC**

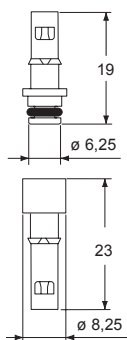

**CX 3.0 PF/PM/VC**

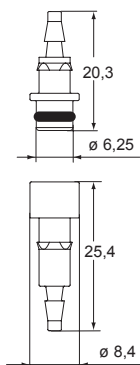

**CX 4.0 PF/PM/VC**

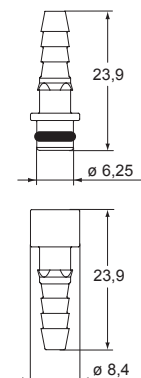

**CX 6.0 PF/PM/VC**

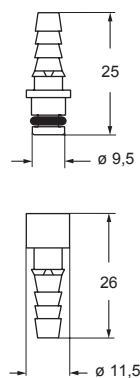

## MIXO FRAMES

Made of die-cast zinc alloy  
with protective earth (PE) contacts

### SUM UP

- ❑ die-cast zinc alloy frames;
- ❑ protective earth (PE);
- ❑ possibility of mounting female and male modular units on the same frame;
- ❑ polarisation on frames;
- ❑ when two or more identical connectors of the MIXO series are used, use of coding pins (CR...CX series) may prevent incorrect coupling.

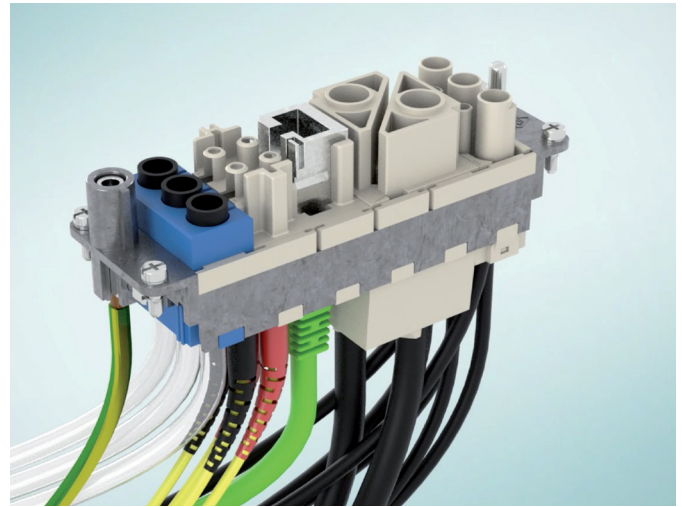



# TECHNICAL FEATURES

## MIXO FRAMES

### HOW TO SELECT FRAMES

- 1 **Calculate** the number of frame slots taken up by the required inserts (frame slot 1, 2 or 3 modules).



	No. of frame slots
CX 01 9VF/M	1
CX 01 9VTF	1
CX 01 GF/M	1
CX 01 J8	1
CX 01 UF/M	1
CX 02 4AF/M	1
CX 02 4BF/M	1
CX 02 4F/M	1
CX 02 7F/M	1
CX 02 CHF/M	1
CX 02 P	1
CX 03 4F/M	1
CX 03 4BF/M	1
CX 03 P	1
CX 3/4 XDF/M	1
CX 04 LF/M	1
CX 04 RF/M	1
CX 04 SCF/M	1
CX 04 XF/M	1
CX 05 SF/M	1
CX 05 SHF/M	1
CX 06 CF/M	1
CX 06P CF/M	1
CX 08 CF/M	1
CX 08 I6F/M	1
CX 12 DF/M	1
CX 17 DF/M	1
CX 25 IBF/M	1
CX 25 IF/M	1
CX FM	1



	No. of frame slots
CX 01 JF/M	2
CX 01 YF/M	2
CX 01 YPEF/M	2
CX 02 BF/M	2
CX 02 GF/M	2
CX 02 HF/M	2
CX 20 CF/M	2
CX 42 DF/M	2

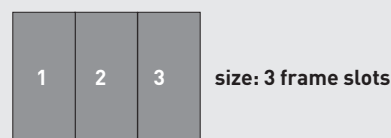

	No. of frame slots
CX 02 JF/M	3

- 2 **Select** the right frame according to the number of required modules (available 1, 2, 3, 4 and 6 modules).

CX 01 T  
1 module



CX 02 TF/TM  
2 modules



CX 03 TF/TM  
3 modules



CX 04 TF/TM  
4 modules



CX 06 TF/TM  
6 modules

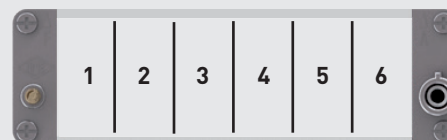

- Fill the unused frame slots with CX FM dummy module

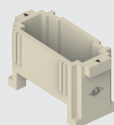

Possibility to use the MIXO **HNM frames** (provided with special gold plated PE contacts) together with R series of crimp contacts and the relevant connector hoods and housings, to produce where

required an **HNM** connector (High Number of Matings, up to 10.000 cycles of operation).

# CX 01 T

enclosures:  
size "49.16"

page:

IL-BRID 374 - 377, 382  
W-TYPE for aggressive environments 519  
E-Xtreme® corrosion proof 540  
EMC 576

panel supports:  
COB + adaptor

page:  
652 - 654

## frames for modular units

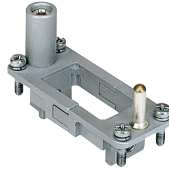

description

part No.

for CZ enclosures

CX 01 T

- die-cast zinc alloy frames
- protective earth (PE)
- polarisation on frames
- coding pins **CR..CX**

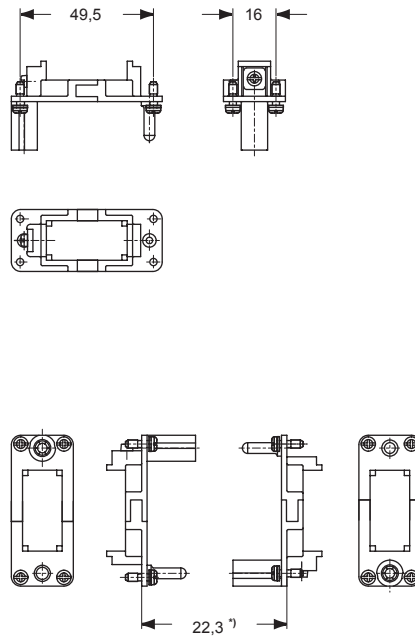

\*) distance for electric contacts: max 24 mm  
distance for pneumatic contacts: max 23,5 mm

- small earth terminal for cables from 1-2,5 mm<sup>2</sup>,  
AWG 18-14

MIXO

# CX 02 TM/TF, CX 03 TM/TF, CX 04 TM/TF, CX 06 TM/TF

<b>enclosures:</b>	<b>page:</b>
C-TYPE IP65/IP66	387 - 430
C7 IP67	436 - 442
V-TYPE IP65/IP66	444 - 463
BIG hoods	466 - 473
T-TYPE IP65 insulating	480 - 487
T-TYPE / W IP66 insulating	489 - 492
HYGIENIC T-TYPE / H IP66/IP69	501 - 504
HYGIENIC T-TYPE / C IP66/IP69, -50 °C	506 - 509
W-TYPE for aggressive environments	521 - 526
E-Xtreme® corrosion proof	530-537, 542-547, 550-557
EMC	578 - 581
Central lever	603 - 614
LS-TYPE	618 - 625
IP68	632 - 647
<b>panel supports:</b>	<b>page:</b>
COB	652 - 653

## frames for modular units with lock-in tabs (included)

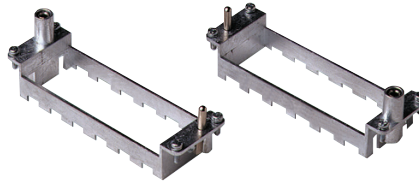

## lock-in tabs



description	part No.	part No.
-------------	----------	----------

frames for modular units (module lock-in tabs included)	type for hoods	type for housings
for 2 modular units - for housing size 44.27	<b>CX 02 TM</b>	<b>CX 02 TF</b>
for 3 modular units - for housing size 57.27	<b>CX 03 TM</b>	<b>CX 03 TF</b>
for 4 modular units - for housing size 77.27 and 77.62	<b>CX 04 TM</b>	<b>CX 04 TF</b>
for 6 modular units - for housing size 104.27 and 104.62	<b>CX 06 TM</b>	<b>CX 06 TF</b>

lock-in tabs (6 units) dividable	CX CFM
----------------------------------	--------

- die-cast zinc alloy frames
- protective earth (PE)
- possibility of mounting female and male modular units on the same frame
- frames supplied with lock-in tabs to attach units
- polarisation on frames
- coding pins **CR..CX**

### Polarisation of frames with relative identification letters and couplings

frame for hoods <sup>1)</sup> frames for housings <sup>1)</sup>

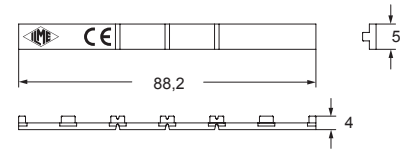
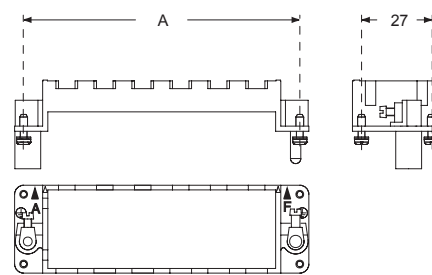
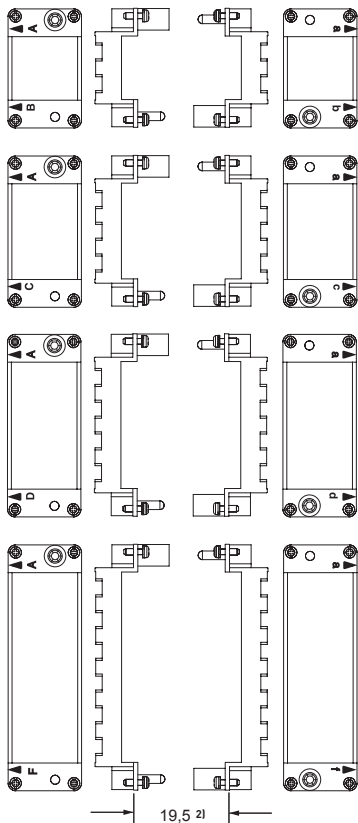

part No.	A (mm)	for housings size
<b>CX 02 TM / TF</b>	44	44,27
<b>CX 03 TM / TF</b>	57	57,27
<b>CX 04 TM / TF</b>	77,5	77,27 and 77,62
<b>CX 06 TM / TF</b>	104	104,27 and 104,62

### Earth terminal

- large: for cables from 4-6 mm<sup>2</sup>, AWG 12-10
- small: for cables from 1-2,5 mm<sup>2</sup>, AWG 18-14

### position of modules (contact side view)

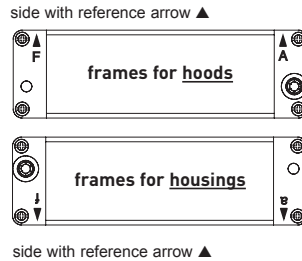

- <sup>1)</sup> **Warning:** The module support frames are marked:
- FOR HOODS: **upper-case A-B, A-C, A-D and A-F**
  - FOR HOUSINGS: **lower-case a-b, a-c, a-d and a-f**

Positioning the modules in the frames according to the respective letters is ensuring the specular assembly of modules, for which the hood will be coupled correctly to the housing.

- <sup>2)</sup> Distance for:
- electric and fibre optic contacts: max 21 mm
  - pneumatic contacts: max 20,5 mm

## CGT 6.0 – CGT 10 – CGT 25

## PE terminal adapters for MIXO frames

- **PE terminal adapter CGT 6.0** made of nickel plated brass that allows to connect by crimping a 6 mm<sup>2</sup> / 10 AWG flexible copper conductor **to the small PE terminal** (2,5 mm<sup>2</sup> / 14 AWG) of a MIXO frame, in case the connector needs a second PE line sized 6 mm<sup>2</sup>/10 AWG when the large PE terminal (6 mm<sup>2</sup>/10 AWG) of the MIXO frame is already occupied by a large size PE conductor, by using the existing PE terminal adapter **CGT 16**, or the new ones for the large PE terminal, **CGT 10** or **CGT 25**.

- **PE terminal adapters CGT 10 and CGT 25** made of nickel plated brass that allow to connect by crimping respectively a 10 mm<sup>2</sup> / 8 AWG or a 25 mm<sup>2</sup> / 4 AWG flexible copper conductor **to the large PE terminal** (6 mm<sup>2</sup>/10 AWG) of a MIXO frame.

- They are offered in addition to the existing PE terminal adapter **CGT 16** for 16 mm<sup>2</sup> / 6 AWG protective earth conductor – introduced with MIXO 100A modules **CX 02 G and CX 01 G** – to give more flexibility for the combination of MIXO 100A and 70A high power modules with **multi-core cables**, that have the PE conductor of the same size of the phase conductors.

- Crimping is achieved by using the already available manual hydraulic crimping tool **CGPZ** (Cembre HT 45) with hexagonal crimping dies **CGD 10 C** (for **CGT 10** with 10 mm<sup>2</sup> / 8 AWG and for **CGT 6.0** with 6 mm<sup>2</sup> / 10 AWG flexible copper conductors) and **CGD 25 C** (for **CGT 25** with 25 mm<sup>2</sup> / 4 AWG flexible copper conductors).

CGT 6.0



CGT 10



CGT 25

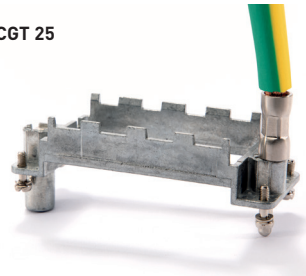

# CGT 6.0 - CGT 10 - CGT 25

The modular inserts must be installed in suitable frames, which are then mounted in traditional enclosures or in COB panel supports.

frames for modular units page:  
286 - 287

## PE terminal adapter

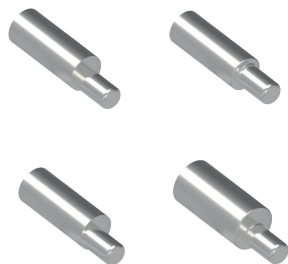

## headless screw M4X6



description	part No.	part No.
PE wire terminal adapter 6 mm <sup>2</sup> (10 AWG)	<b>CGT 6.0</b>	
PE wire terminal adapter 10 mm <sup>2</sup> (8 AWG)	<b>CGT 10</b>	
PE wire terminal adapter 16 mm <sup>2</sup> (6 AWG) *	<b>CGT 16</b>	
PE wire terminal adapter 25 mm <sup>2</sup> (4 AWG)	<b>CGT 25</b>	
headless screw M4X6, stainless steel, kit of 10 pcs. (see point 5 below)		<b>CR VGM4</b>

\* CGT 16 already available

### How to use the PE terminal adapter

- 1) Strip 15 mm of flexible PE wire.
- 2) Crimp the cable on the CGT adapter by using the CGPZ pliers with the dies as follows:
  - **CGD 10 C** for 6 mm<sup>2</sup> and 10 mm<sup>2</sup>
  - **CGD 16 C** for 16 mm<sup>2</sup>
  - **CGD 25 C** for 25 mm<sup>2</sup>
- 3) Fix the adapter tip in the larger earth terminal (6 mm<sup>2</sup>) for CGT 10, CGT 16, CGT 25 or in the smaller earth terminal (2,5 mm<sup>2</sup>) for CGT 6.0 of frames CX...TM/TF.
- 4) To be used with bulkhead mounting housings or high construction hoods.
- 5) Cannot be used with T-TYPE surface mounting housings and horizontal cable outlet hoods. For the use within bulkhead housings and vertical entry hoods it is needed to replace the M4 screw of the 6 mm<sup>2</sup> PE contact of the frame with the headless screw **CR VGM4**.

### CGT 6.0

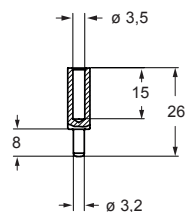

### CGT 10

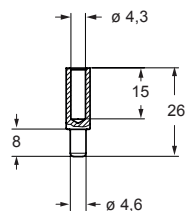

### CGT 16

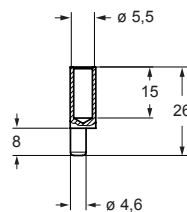

### CGT 25

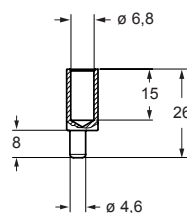

cURus pending

## MODULES FOR HIGH NUMBER OF MATINGS

Within the range of **series HNM**, for High Number of Matings, all MIXO modules for crimp contacts 40A, 16A and/or 10A, combined with the use of especially high thickness gold-plated/lubricated crimp contacts of:

- series **RX** (40A HNM variant of series CX),
- series **RC** (16A HNM variant of series CC), and
- series **RD** (10A HNM variant of series CD)

mounted in the dedicated **MIXO HNM frames** cat. nos. **RX 02 /03 /04 /06 TF /TM**, also employing especially gold-plated PE contacts, allow the creation of **HNM** modular connector inserts.

The connector modules of series MIXO that by using HNM 40A contacts series **RX**, HNM 16A contacts series **RC** and/or HNM 10A contacts series **RD** together with **MIXO HNM frames** RX 02...06 TF/M can create MIXO HNM modular connector inserts are:

- **CX 02 4F/M, CX 03 4F/M, CX 03 4BF/M** and **CX 04 XF/XM** (with **RX** HNM contacts)
- **CX 3/4 XDF/M** (with **RX** and **RD** HNM contacts)
- **CX 06 CF/M, CX 06P CF/M, CX 08 CF/M** and **CX 20 CF/M** (with **RC** HNM contacts)
- **CX 12 DF/M, CX 17 DF/M** and **CX 42 DF/M** (with **RD** HNM contacts)

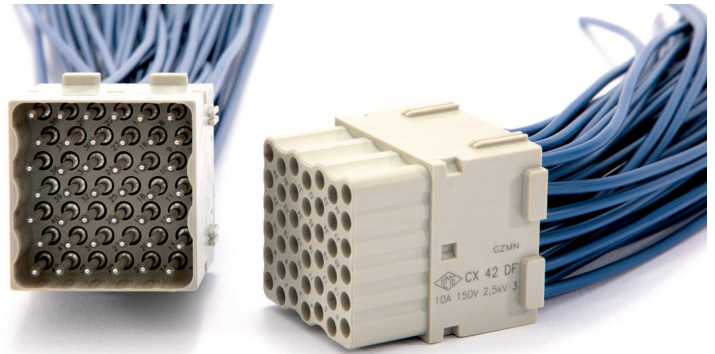

### SUM UP

- ☒ up to 10.000 matings in combination with HNM enclosures;
- ☒ up to 5.000 matings with standard hoods with single lever.





The modular inserts must be installed in suitable frames, which are then mounted in traditional enclosures\* or in COB panel supports.

frames for modular units\*

page: 286

\* enclosures: bulkhead mounting housings, high construction housings or high construction hoods

modular units, crimp connections

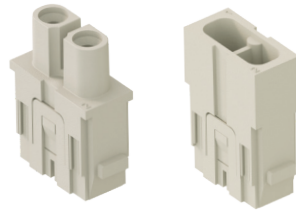

Q 10.000 MATINGS WITH HNM FRAMES AND HNM ENCLOSURES

Q 5.000 MATINGS WITH HNM FRAMES AND STANDARD ENCLOSURES, SINGLE LEVER

40A crimp contacts gold plated



description	part No.	part No.
-------------	----------	----------

without contacts (to be ordered separately)  
female inserts for female contacts \*  
male inserts for male contacts \*

CX 02 4F  
CX 02 4M

40A female crimp contacts  
1,5 mm<sup>2</sup> AWG 16  
2,5 mm<sup>2</sup> AWG 14  
4 mm<sup>2</sup> AWG 12  
6 mm<sup>2</sup> AWG 10  
10 mm<sup>2</sup> AWG 8

RXF2D 1.5  
RXF2D 2.5  
RXF2D 4.0  
RXF2D 6.0  
RXF2D 10

gold plated

40A male crimp contacts  
1,5 mm<sup>2</sup> AWG 16  
2,5 mm<sup>2</sup> AWG 14  
4 mm<sup>2</sup> AWG 12  
6 mm<sup>2</sup> AWG 10  
10 mm<sup>2</sup> AWG 8

RXM2D 1.5  
RXM2D 2.5  
RXM2D 4.0  
RXM2D 6.0  
RXM2D 10

\* cable diameter up to 7,5 mm  
contact size up to 10 mm<sup>2</sup>

- characteristics according to EN 61984:  
**40A 1000V 8kV 3**
- certified
- insulation resistance: ≥ 10 GΩ
- ambient temperature limit: -40 °C ... +125 °C
- made of self-extinguishing thermoplastic resin UL 94V-0
- mechanical life: ≥ 10.000 cycles
- contact resistance: ≤ 0,3 mΩ
- can be mated with CX 02 A/B modules
- **it is recommended to crimp the contacts (1,5 - 10 mm<sup>2</sup>), with crimping tools homologated by ILME** (please see the crimping tool section 40A contacts, RXF2D and RXM2D series) on pages 705 - 741
- for max. current load see the connector inserts derating diagram below; for more information see page 28

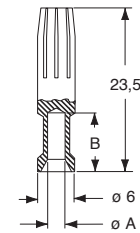
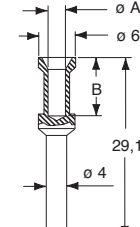
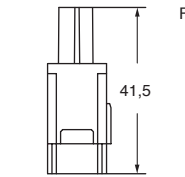
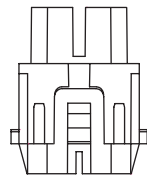
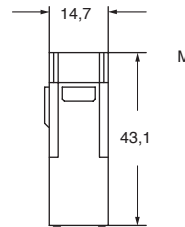
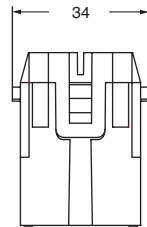

contacts side (front view)

side with reference arrow ▲

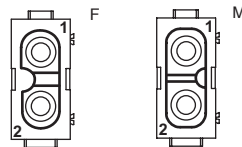

- 1 frame slot

CX 02 4, 2 poles connector inserts  
Maximum current load derating diagram

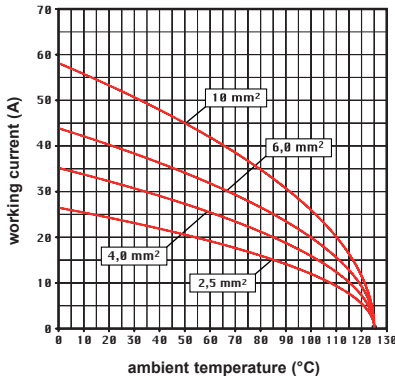

RXF2D and RXM2D contacts

conductor section (mm <sup>2</sup> )	conductor slot ø A (mm)	conductor stripping length B (mm)
1,5	1,8	9
2,5	2,2	9
4	2,85	9,6
6	3,5	9,6
10	4,3	15

The modular inserts must be installed in suitable frames, which are then mounted in traditional enclosures or in COB panel supports.

frames for modular units

page: 286

modular units, crimp connections

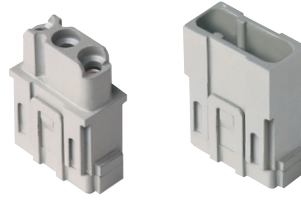

Q 10.000 MATINGS WITH HNM FRAMES AND HNM ENCLOSURES

Q 5.000 MATINGS WITH HNM FRAMES AND STANDARD ENCLOSURES, SINGLE LEVER

40A crimp contacts gold plated



description

part No.

part No

without contacts (to be ordered separately)  
female inserts for female contacts \*  
male inserts for male contacts \*

CX 03 4F  
CX 03 4M

40A female crimp contacts  
1,5 mm<sup>2</sup> AWG 16  
2,5 mm<sup>2</sup> AWG 14  
4 mm<sup>2</sup> AWG 12  
6 mm<sup>2</sup> AWG 10

RXF2D 1.5  
RXF2D 2.5  
RXF2D 4.0  
RXF2D 6.0

gold plated

40A male crimp contacts  
1,5 mm<sup>2</sup> AWG 16  
2,5 mm<sup>2</sup> AWG 14  
4 mm<sup>2</sup> AWG 12  
6 mm<sup>2</sup> AWG 10

RXM2D 1.5  
RXM2D 2.5  
RXM2D 4.0  
RXM2D 6.0

\* cable diameter up to 5 mm

- characteristics according to EN 61984:

**40A 400/690V 6kV 3**

- cULus (UL for USA and Canada), VDE, CEC, DNV-GL

BUREAU VERITAS ENEC certified

- rated voltage according to UL/CSA: 600V

- insulation resistance: ≥ 10 GΩ

- ambient temperature limit: -40 °C ... +125 °C

- made of self-extinguishing thermoplastic resin UL 94V-0

- mechanical life: ≥ 10.000 cycles

- contact resistance: ≤ 0,3 mΩ

- it is recommended to crimp the contacts with crimping tools homologated by ILME (please see the crimping tool section 40A contacts, RXF2D and RXM2D series) on pages 705 - 741

- for max. current load see the connector inserts derating diagram below; for more information see page 28

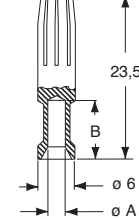
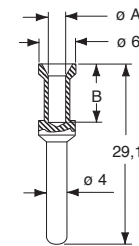
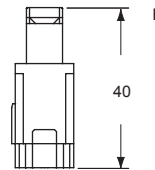
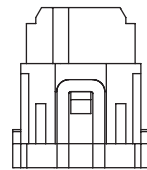
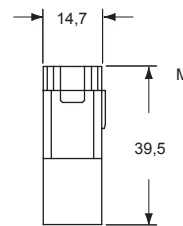
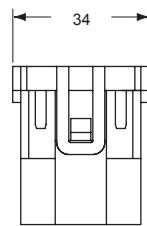

contacts side (front view)

side with reference arrow ▲

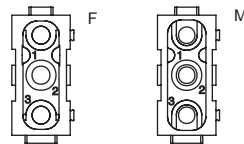

- 1 frame slot

RXF2D and RXM2D contacts

conductor section (mm <sup>2</sup> )	conductor slot ø A (mm)	conductor stripping length B (mm)
1,5	1,8	9
2,5	2,2	9
4	2,85	9,6
6	3,5	9,6

CX 03 poles connector inserts  
Maximum current load derating diagram

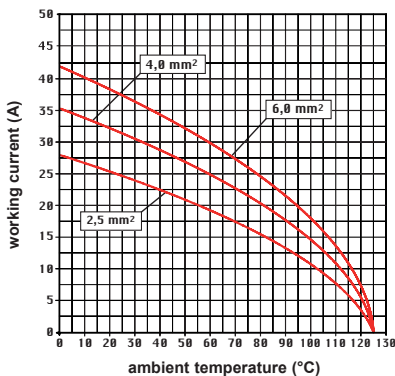

MIXO - HNM



The modular inserts must be installed in suitable frames, which are then mounted in traditional enclosures\* or in COB panel supports.

frames for modular units\*

page: 286

\* enclosures: bulkhead mounting housings, high construction housings or high construction hoods

modular units, crimp connections

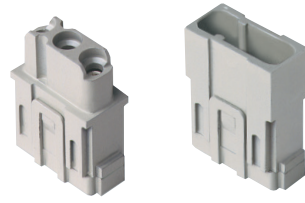

**Q 10.000 MATINGS WITH HNM FRAMES AND HNM ENCLOSURES**

**Q 5.000 MATINGS WITH HNM FRAMES AND STANDARD ENCLOSURES, SINGLE LEVER**

40A crimp contacts gold plated



description	part No.	part No.
-------------	----------	----------

without contacts (to be ordered separately)  
female inserts for female contacts \*  
male inserts for male contacts \*

**CX 03 4BF**  
**CX 03 4BM**

40A female crimp contacts  
1,5 mm<sup>2</sup> AWG 16  
2,5 mm<sup>2</sup> AWG 14  
4 mm<sup>2</sup> AWG 12  
6 mm<sup>2</sup> AWG 10  
10 mm<sup>2</sup> AWG 8

**RXF2D 1.5**  
**RXF2D 2.5**  
**RXF2D 4.0**  
**RXF2D 6.0**  
**RXF2D 10**

gold plated

40A male crimp contacts  
1,5 mm<sup>2</sup> AWG 16  
2,5 mm<sup>2</sup> AWG 14  
4 mm<sup>2</sup> AWG 12  
6 mm<sup>2</sup> AWG 10  
10 mm<sup>2</sup> AWG 8

**RXM2D 1.5**  
**RXM2D 2.5**  
**RXM2D 4.0**  
**RXM2D 6.0**  
**RXM2D 10**

\* cable diameter up to 7,5 mm  
contact size up to 10 mm<sup>2</sup>

- characteristics according to EN 61984:

**40A 500V 6kV 3**

- cULus (UL for USA and Canada),

- certified

- insulation resistance: ≥ 10 GΩ

- ambient temperature limit: -40 °C ... +125 °C

- made of self-extinguishing thermoplastic resin  
UL 94V-0

- mechanical life: ≥ 10.000 cycles

- contact resistance: ≤ 0,3 mΩ

- can be mated with CX 02 A/B modules

- **it is recommended to crimp the contacts**  
(1,5 - 10 mm<sup>2</sup>), **with crimping tools homologated by ILME** (please see the crimping tool section 40A contacts, RXF2D and RXM2D series) on pages 705 - 741

- for max. current load see the connector inserts derating diagram below; for more information see page 28

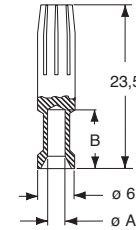
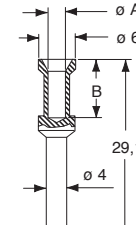
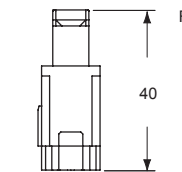
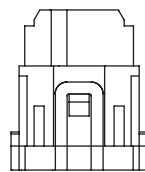
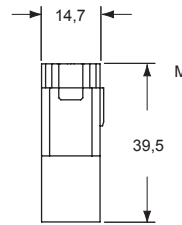
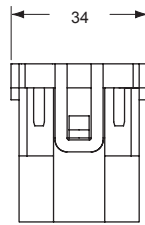

contacts side (front view)

side with reference arrow ▲

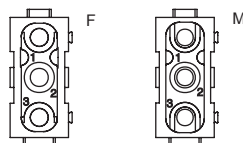

- 1 frame slot

**CX 03 4B, 3 poles connector inserts**  
**Maximum current load derating diagram**

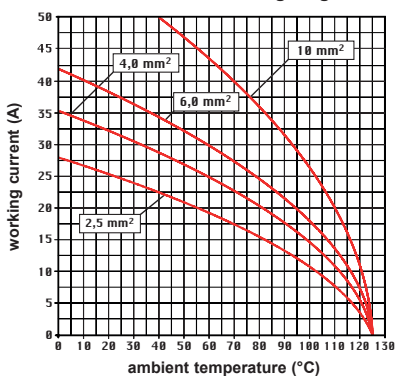

**RXF2D and RXM2D contacts**

conductor section (mm <sup>2</sup> )	conductor slot ø A (mm)	conductor stripping length B (mm)
1,5	1,8	9
2,5	2,2	9
4	2,85	9,6
6	3,5	9,6
10	4,3	15

The modular inserts must be installed in suitable frames, which are then mounted in traditional enclosures or in COB panel supports.

page:

frames for modular units

286

- male and female contacts finger proof
- their key characteristic lies in the fact that they **guarantee maximum safety even in case of accidental contact with fingers (IP2X or IPXXB)**. Safety is guaranteed as standard on female contacts, **but also on male contacts**. This feature is important as it ensures full compliance with the recent safety standard **EN 60204-1**, concerning electric equipment fitted on machines and in particular with the requirements of Article 6.2.4 concerning protection against residual voltage. **In the case of plugs or similar devices, the with drawal of which results in the exposure of conductors (for example pins), the discharge time shall not exceed 1 s, otherwise such conductors shall be protected against direct contact to at least an IP2X or IPXXB.**

modular units, crimp connections

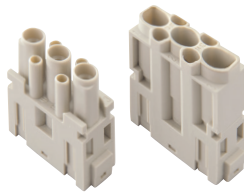

**Q 10.000 MATINGS WITH HNM FRAMES AND HNM ENCLOSURES**

**Q 5.000 MATINGS WITH HNM FRAMES AND STANDARD ENCLOSURES, SINGLE LEVER**

40A and 10A crimp contacts gold plated

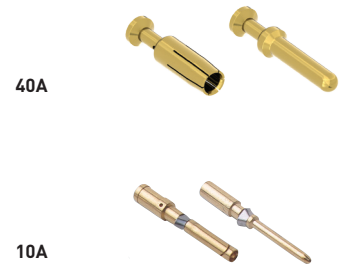

description

part No.

part No

without contacts (to be ordered separately)

female inserts for female contacts

male inserts for male contacts

**CX 3/4 XDF**  
**CX 3/4 XDM**

40A female crimp contacts

1,5 mm <sup>2</sup>	AWG 16
2,5 mm <sup>2</sup>	AWG 14
4 mm <sup>2</sup>	AWG 12
6 mm <sup>2</sup>	AWG 10

40A male crimp contacts

1,5 mm <sup>2</sup>	AWG 16
2,5 mm <sup>2</sup>	AWG 14
4 mm <sup>2</sup>	AWG 12
6 mm <sup>2</sup>	AWG 10

10A female crimp contacts

0,14-0,37 mm <sup>2</sup>	AWG 26-22	identification No. 1
0,5 mm <sup>2</sup>	AWG 20	identification No. 2
0,75 mm <sup>2</sup>	AWG 18	identification No. ②
1 mm <sup>2</sup>	AWG 18	identification No. 3
1,5 mm <sup>2</sup>	AWG 16	identification No. 4
2,5 mm <sup>2</sup>	AWG 14	identification No. 5

10A male crimp contacts

0,14-0,37 mm <sup>2</sup>	AWG 26-22	identification No. 1
0,5 mm <sup>2</sup>	AWG 20	identification No. 2
0,75 mm <sup>2</sup>	AWG 18	identification No. ②
1 mm <sup>2</sup>	AWG 18	identification No. 3
1,5 mm <sup>2</sup>	AWG 16	identification No. 4
2,5 mm <sup>2</sup>	AWG 14	identification No. 5

**RXF2D 1.5**  
**RXF2D 2.5**  
**RXF2D 4.0**  
**RXF2D 6.0**

**RXM2D 1.5**  
**RXM2D 2.5**  
**RXM2D 4.0**  
**RXM2D 6.0**

**RDF2D 0.3**  
**RDF2D 0.5**  
**RDF2D 0.7**  
**RDF2D 1.0**  
**RDF2D 1.5**  
**RDF2D 2.5**

**RDM2D 0.3**  
**RDM2D 0.5**  
**RDM2D 0.7**  
**RDM2D 1.0**  
**RDM2D 1.5**  
**RDM2D 2.5**

gold plated

- characteristics according to EN 61984:

- 3 poles 40A 830V 8kV 3**
- 4 poles 10A 830V 8kV 3**
- **UL** (UL for USA and Canada), **CEC**, **DNV-GL**
- **BUREAU VERITAS ERI** certified
- rated voltage according to UL/CSA: 600V
- insulation resistance:  $\geq 10 \text{ G}\Omega$
- ambient temperature limit:  $-40 \text{ }^\circ\text{C} \dots +125 \text{ }^\circ\text{C}$
- made of self-extinguishing thermoplastic resin UL 94V-0
- mechanical life:  $\geq 10.000$  cycles
- contact resistance:  $\leq 0,3 \text{ m}\Omega$  (3 poles),  $\leq 3 \text{ m}\Omega$  (4 poles)
- for max. current load see the connector inserts derating diagram below; for more information see page 28

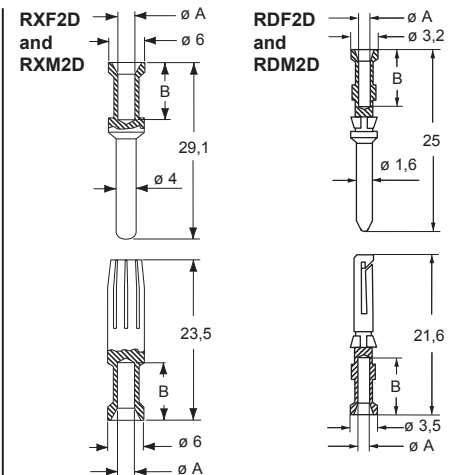
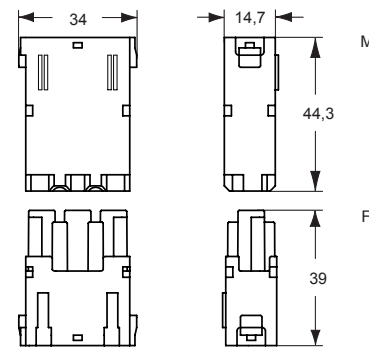

**RXF2D and RXM2D contacts**

conductor section (mm <sup>2</sup> )	conductor slot $\varnothing A$ (mm)	conductors stripping length B (mm)
1,5	1,8	9
2,5	2,2	9
4	2,85	9,6
6	3,5	9,6

**RDF2D and RDM2D contacts**

0,14-0,37	0,9	8
0,5	1,1	8
0,75	1,3	8
1,0	1,45	8
1,5	1,8	8
2,5	2,2	6

**CX 3/4 poles connector inserts**  
**Maximum current load derating diagram**

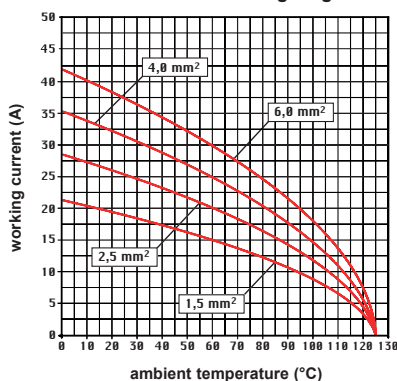

contacts side (front view)

side with reference arrow ▲

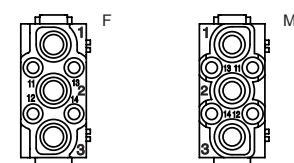

- 1 frame slot

- it is recommended to crimp the contacts with **crimping tools homologated by ILME** (please see the crimping tool section 40A contacts, RXF2D, RXM2D series and 10A contacts RDF2D, RDM2D series) on pages 705 - 741

MIXO - HNM



The modular inserts must be installed in suitable frames, which are then mounted in traditional enclosures\* or in COB panel supports.

frames for modular units\*

page: 286

\* enclosures: bulkhead mounting housings, high construction housings or high construction hoods

modular units, crimp connections with red lock-in tabs (included)

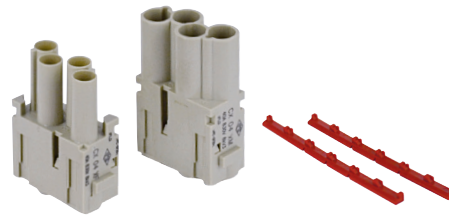

Q 10.000 MATINGS WITH HNM FRAMES AND HNM ENCLOSURES

Q 5.000 MATINGS WITH HNM FRAMES AND STANDARD ENCLOSURES, SINGLE LEVER

40A crimp contacts gold plated



description	part No.	part No.
-------------	----------	----------

without contacts (to be ordered separately)  
(module red lock-in tabs included)  
female inserts for female contacts  
male inserts for male contacts

CX 04 XF  
CX 04 XM

40A female crimp contacts  
1,5 mm<sup>2</sup> AWG 16  
2,5 mm<sup>2</sup> AWG 14  
4 mm<sup>2</sup> AWG 12  
6 mm<sup>2</sup> AWG 10

RXF2D 1.5  
RXF2D 2.5  
RXF2D 4.0  
RXF2D 6.0

gold plated

40A male crimp contacts  
1,5 mm<sup>2</sup> AWG 16  
2,5 mm<sup>2</sup> AWG 14  
4 mm<sup>2</sup> AWG 12  
6 mm<sup>2</sup> AWG 10

RXM2D 1.5  
RXM2D 2.5  
RXM2D 4.0  
RXM2D 6.0

- characteristics according to EN 61984:

**40A 830V 8kV 3**  
**40A 1000V 8kV 2**

- cULus (UL for USA and Canada), SFA, CEC, DNV-GL

BUREAU VERITAS ERI certified

- rated voltage according to UL/CSA: 600V

- insulation resistance:  $\geq 10 \text{ G}\Omega$

- ambient temperature limit:  $-40 \text{ }^\circ\text{C} \dots +125 \text{ }^\circ\text{C}$

- made of self-extinguishing thermoplastic resin UL 94V-0

- mechanical life:  $\geq 10.000$  cycles

- contact resistance:  $\leq 0,3 \text{ m}\Omega$

- it is recommended to crimp the contacts with crimping tools homologated by ILME (please see the crimping tool section 40A contacts, RXF2D and RXM2D series) on pages 705 - 741

- for max. current load see the connector inserts derating diagram below; for more information see page 28

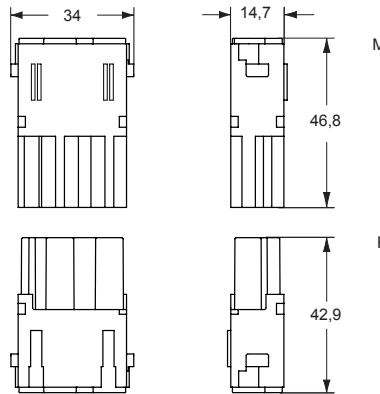

contacts side (front view)  
side with reference arrow ▲

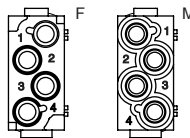

- 1 frame slot

Female inserts are supplied with two red lock tabs that must be used instead of those supplied with the frames.

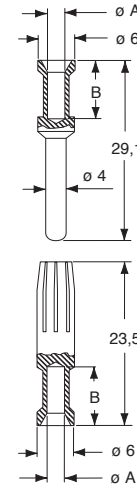
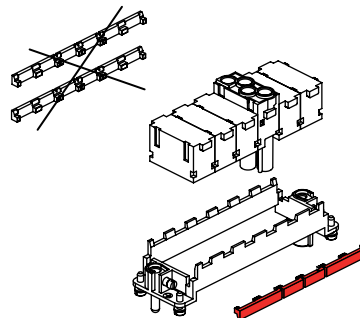

RXF2D and RXM2D contacts

conductor section (mm <sup>2</sup> )	conductor slot $\phi A$ (mm)	conductor stripping length B (mm)
1,5	1,8	9
2,5	2,2	9
4	2,85	9,6
6	3,5	9,6

- male and female contacts finger proof  
- their key characteristic lies in the fact that they guarantee maximum safety even in case of accidental contact with fingers (IP2X or IPXXB). Safety is guaranteed as standard on female contacts, but also on male contacts. This feature is important as it ensures full compliance with the recent safety standard EN 60204-1, concerning electric equipment fitted on machines and in particular with the requirements of Article 6.2.4 concerning protection against residual voltage. In the case of plugs or similar devices, the with drawal of which results in the exposure of conductors (for example pins), the discharge time shall not exceed 1 s, otherwise such conductors shall be protected against direct contact to at least an IP2X or IPXXB.

CX 04 poles connector inserts  
Maximum current load derating diagram

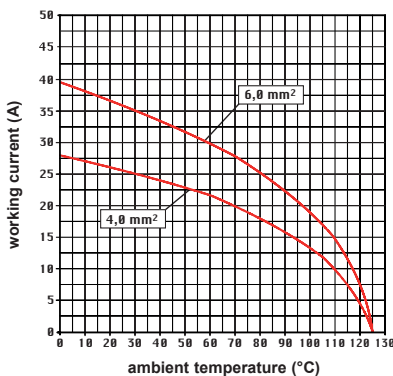

The modular inserts must be installed in suitable frames, which are then mounted in traditional enclosures or in COB panel supports.

frames for modular units

page: 286

modular units, crimp connections

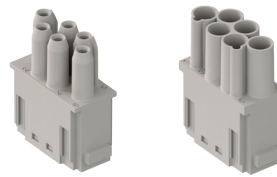

**RATING 830V**

**Q 10.000 MATINGS WITH HNM FRAMES AND HNM ENCLOSURES**

**Q 5.000 MATINGS WITH HNM FRAMES AND STANDARD ENCLOSURES, SINGLE LEVER**

16A crimp contacts gold plated



description

part No.

part No.

without contacts (to be ordered separately)  
female inserts for female contacts  
male inserts for male contacts

**CX 06P CF**  
**CX 06P CM**

16A female contacts

0,14-0,37 mm <sup>2</sup>	AWG 26-22	one groove
0,5 mm <sup>2</sup>	AWG 20	with no grooves
0,75 mm <sup>2</sup>	AWG 18	one groove (back side)
1 mm <sup>2</sup>	AWG 18	one groove
1,5 mm <sup>2</sup>	AWG 16	two grooves
2,5 mm <sup>2</sup>	AWG 14	three grooves
3 mm <sup>2</sup>	AWG 12	one wide groove
4 mm <sup>2</sup>	AWG 12	with no grooves

**RCF2D 0.3**  
**RCF2D 0.5**  
**RCF2D 0.7**  
**RCF2D 1.0**  
**RCF2D 1.5**  
**RCF2D 2.5**  
**RCF2D 3.0**  
**RCF2D 4.0**

gold plated

16A male contacts

0,14-0,37 mm <sup>2</sup>	AWG 26-22	one groove
0,5 mm <sup>2</sup>	AWG 20	with no grooves
0,75 mm <sup>2</sup>	AWG 18	one groove (back side)
1 mm <sup>2</sup>	AWG 18	one groove
1,5 mm <sup>2</sup>	AWG 16	two grooves
2,5 mm <sup>2</sup>	AWG 14	three grooves
3 mm <sup>2</sup>	AWG 12	one wide groove
4 mm <sup>2</sup>	AWG 12	with no grooves

**RCM2D 0.3**  
**RCM2D 0.5**  
**RCM2D 0.7**  
**RCM2D 1.0**  
**RCM2D 1.5**  
**RCM2D 2.5**  
**RCM2D 3.0**  
**RCM2D 4.0**

- characteristics according to EN 61984:

**16A 830V 8kV 3**

- **BUREAU VERITAS** certified
- rated voltage according to UL/CSA: 600V
- insulation resistance:  $\geq 10 \text{ G}\Omega$
- ambient temperature limit:  $-40 \text{ }^\circ\text{C} \dots +125 \text{ }^\circ\text{C}$
- made of self-extinguishing thermoplastic resin UL 94V-0
- mechanical life:  $\geq 10.000$  cycles
- contact resistance:  $\leq 1 \text{ m}\Omega$
- **it is recommended to crimp the contacts with crimping tools homologated by ILME** (please see the crimping tool section 16A contacts, RCF2D and RCM2D series) on pages 705 - 741
- for max. current load see the connector inserts derating diagram below; for more information see page 28

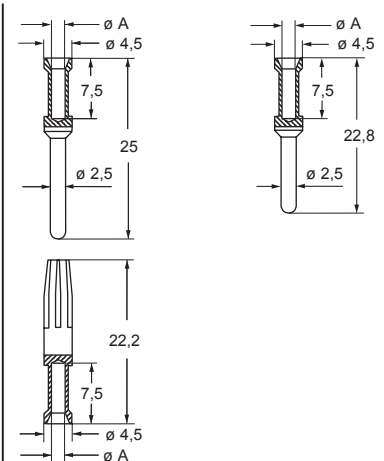
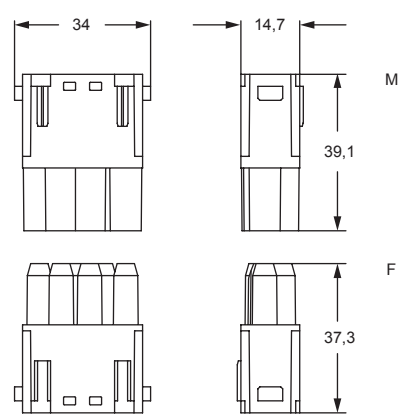

**RCF2D and RCM2D contacts**

conductor section (mm <sup>2</sup> )	conductor slot $\varnothing A$ (mm)	conductors stripping length (mm)
0,14-0,37	0,9	7,5
0,5	1,1	7,5
0,75	1,3	7,5
1,0	1,45	7,5
1,5	1,8	7,5
2,5	2,2	7,5
3	2,55	7,5
4	2,85	7,5

**CX 06 poles connector inserts**  
**Maximum current load derating diagram**

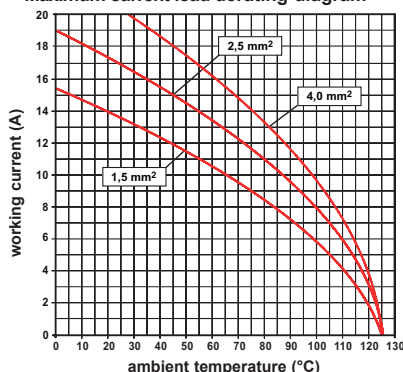

contacts side (front view)

side with reference arrow ▲

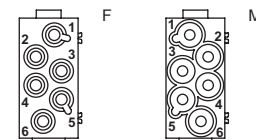

- 1 frame slot

MIXO - HNM





The modular inserts must be installed in suitable frames, which are then mounted in traditional enclosures or in COB panel supports.

frames for modular units

page: 286

modular units, crimp connections

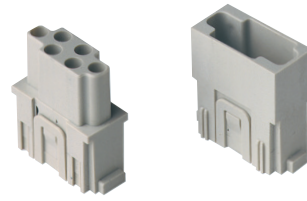

Q 10.000 MATINGS WITH HNM FRAMES AND HNM ENCLOSURES

Q 5.000 MATINGS WITH HNM FRAMES AND STANDARD ENCLOSURES, SINGLE LEVER

16A crimp contacts gold plated



description	part No.	part No.
-------------	----------	----------

without contacts (to be ordered separately)  
female inserts for female contacts  
male inserts for male contacts

CX 06 CF  
CX 06 CM

16A female contacts

Area (mm <sup>2</sup> )	AWG	Configuration
0,14-0,37	26-22	one groove
0,5	20	with no grooves
0,75	18	one groove (back side)
1	18	one groove
1,5	16	two grooves
2,5	14	three grooves
3	12	one wide groove
4	12	with no grooves

RCF2D 0.3  
RCF2D 0.5  
RCF2D 0.7  
RCF2D 1.0  
RCF2D 1.5  
RCF2D 2.5  
RCF2D 3.0  
RCF2D 4.0

gold plated

16A male contacts

Area (mm <sup>2</sup> )	AWG	Configuration
0,14-0,37	26-22	one groove
0,5	20	with no grooves
0,75	18	one groove (back side)
1	18	one groove
1,5	16	two grooves
2,5	14	three grooves
3	12	one wide groove
4	12	with no grooves

RCM2D 0.3  
RCM2D 0.5  
RCM2D 0.7  
RCM2D 1.0  
RCM2D 1.5  
RCM2D 2.5  
RCM2D 3.0  
RCM2D 4.0

- characteristics according to EN 61984:

**16A 500V 6kV 3**  
**16A 400/690V 6kV 2**

- certified

- rated voltage according to UL/CSA: 600V

- insulation resistance: ≥ 10 GΩ

- ambient temperature limit: -40 °C ... +125 °C

- made of self-extinguishing thermoplastic resin UL 94V-0

- mechanical life: ≥ 10.000 cycles

- contact resistance: ≤ 1 mΩ

- **it is recommended to crimp the contacts with crimping tools homologated by ILME** (please see the crimping tool section 16A contacts, RCF2D and RCM2D series) on pages 705 - 741

- for max. current load see the connector inserts derating diagram below; for more information see page 28

CX 06 poles connector inserts  
Maximum current load derating diagram

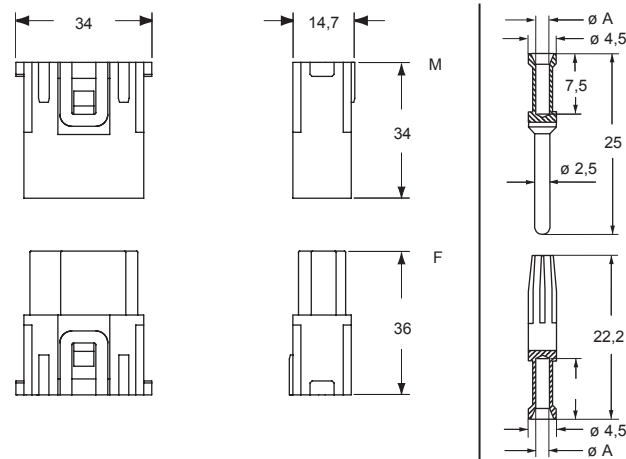
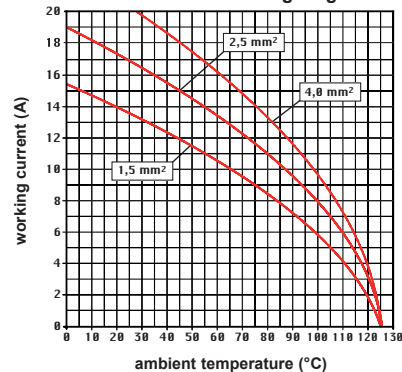

contacts side (front view)

side with reference arrow ▲

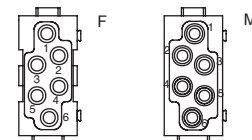

- 1 frame slot

RCF2D and RCM2D contacts

conductor section mm <sup>2</sup>	conductor slot ø A (mm)	conductors stripping length (mm)
0,14-0,37	0,9	7,5
0,5	1,1	7,5
0,75	1,3	7,5
1,0	1,45	7,5
1,5	1,8	7,5
2,5	2,2	7,5
3	2,55	7,5
4	2,85	7,5

The modular inserts must be installed in suitable frames, which are then mounted in traditional enclosures or in COB panel supports.

frames for modular units

page:  
286

modular units, crimp connections

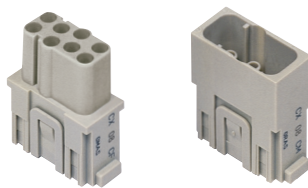

**Q 10.000 MATINGS WITH HNM FRAMES AND HNM ENCLOSURES**

**Q 5.000 MATINGS WITH HNM FRAMES AND STANDARD ENCLOSURES, SINGLE LEVER**

16A crimp contacts  
gold plated



description

part No.

part No

without contacts (to be ordered separately)  
female inserts for female contacts  
male inserts for male contacts

**CX 08 CF**  
**CX 08 CM**

16A female contacts

0,14-0,37 mm <sup>2</sup>	AWG 26-22	one groove
0,5 mm <sup>2</sup>	AWG 20	with no grooves
0,75 mm <sup>2</sup>	AWG 18	one groove (back side)
1 mm <sup>2</sup>	AWG 18	one groove
1,5 mm <sup>2</sup>	AWG 16	two grooves
2,5 mm <sup>2</sup>	AWG 14	three grooves
3 mm <sup>2</sup>	AWG 12	one wide groove
4 mm <sup>2</sup>	AWG 12	with no grooves

**RCF2D 0.3**  
**RCF2D 0.5**  
**RCF2D 0.7**  
**RCF2D 1.0**  
**RCF2D 1.5**  
**RCF2D 2.5**  
**RCF2D 3.0**  
**RCF2D 4.0**

gold plated

16A male contacts

0,14-0,37 mm <sup>2</sup>	AWG 26-22	one groove
0,5 mm <sup>2</sup>	AWG 20	with no grooves
0,75 mm <sup>2</sup>	AWG 18	one groove (back side)
1 mm <sup>2</sup>	AWG 18	one groove
1,5 mm <sup>2</sup>	AWG 16	two grooves
2,5 mm <sup>2</sup>	AWG 14	three grooves
3 mm <sup>2</sup>	AWG 12	one wide groove
4 mm <sup>2</sup>	AWG 12	with no grooves

**RCM2D 0.3**  
**RCM2D 0.5**  
**RCM2D 0.7**  
**RCM2D 1.0**  
**RCM2D 1.5**  
**RCM2D 2.5**  
**RCM2D 3.0**  
**RCM2D 4.0**

- characteristics according to EN 61984:

**16A 500V 6kV 3**  
**16A 400/690V 6kV 2**

- certified

- rated voltage according to UL/CSA: 600V

- insulation resistance:  $\geq 10 \text{ G}\Omega$

- ambient temperature limit: -40 °C ... +125 °C

- made of self-extinguishing thermoplastic resin  
UL 94V-0

- mechanical life:  $\geq 10.000$  cycles

- contact resistance:  $\leq 1 \text{ m}\Omega$

- **it is recommended to crimp the contacts with crimping tools homologated by ILME** (please see the crimping tool section 16A contacts, RCF2D and RCM2D series) on pages 705 - 741

- for max. current load see the connector inserts derating diagram below; for more information see page 28

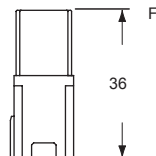
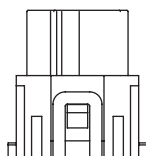
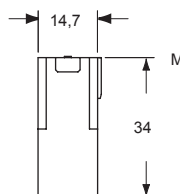
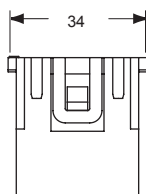

contacts side (front view)

side with reference arrow ▲

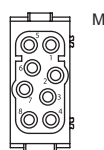
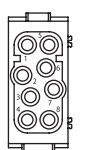

- 1 frame slot

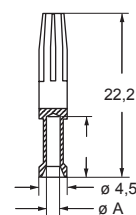
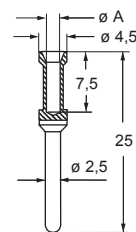

**RCF2D and RCM2D contacts**

conductor section	conductor slot $\varnothing A$ (mm)	conductors stripping length (mm)
0,14-0,37	0,9	7,5
0,5	1,1	7,5
0,75	1,3	7,5
1,0	1,45	7,5
1,5	1,8	7,5
2,5	2,2	7,5
3	2,55	7,5
4	2,85	7,5

**CX 08 poles connector inserts**  
**Maximum current load derating diagram**

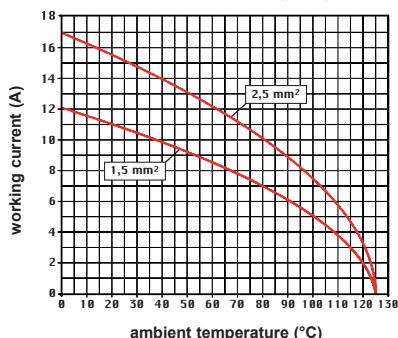



The modular inserts must be installed in suitable frames, which are then mounted in traditional enclosures or in COB panel supports.

frames for modular units

page: 286

modular units, crimp connections

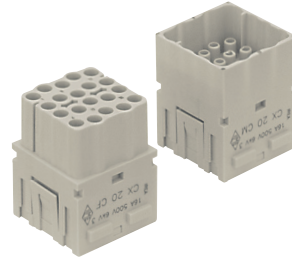

Q 10.000 MATINGS WITH HNM FRAMES AND HNM ENCLOSURES

Q 5.000 MATINGS WITH HNM FRAMES AND STANDARD ENCLOSURES, SINGLE LEVER

16A crimp contacts gold plated



description	part No.	part No.
-------------	----------	----------

without contacts (to be ordered separately)  
female inserts for female contacts \*  
male inserts for male contacts \*

CX 20 CF  
CX 20 CM

16A female contacts

Area (mm²)	AWG	Configuration
0,14-0,37	26-22	one groove
0,5	20	with no grooves
0,75	18	one groove (back side)
1	18	one groove
1,5	16	two grooves
2,5	14	three grooves
3	12	one wide groove
4	12	with no grooves

RCF2D 0.3
RCF2D 0.5
RCF2D 0.7
RCF2D 1.0
RCF2D 1.5
RCF2D 2.5
RCF2D 3.0
RCF2D 4.0

gold plated

16A male contacts

Area (mm²)	AWG	Configuration
0,14-0,37	26-22	one groove
0,5	20	with no grooves
0,75	18	one groove (back side)
1	18	one groove
1,5	16	two grooves
2,5	14	three grooves
3	12	one wide groove
4	12	with no grooves

RCM2D 0.3
RCM2D 0.5
RCM2D 0.7
RCM2D 1.0
RCM2D 1.5
RCM2D 2.5
RCM2D 3.0
RCM2D 4.0

\* on request, version with 3 fastened CX 20 CF/CM inserts with poles numbered from 1 – 60  
references: CX 60 CF, CX 60 CM

- characteristics according to EN 61984:

16A 500V 6kV 3  
16A 830V 8kV 2

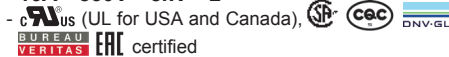

- rated voltage according to UL/CSA: 600V
- insulation resistance:  $\geq 10 \text{ G}\Omega$
- ambient temperature limit:  $-40 \text{ }^\circ\text{C} \dots +125 \text{ }^\circ\text{C}$
- made of self-extinguishing thermoplastic resin UL 94V-0
- mechanical life:  $\geq 10.000$  cycles
- contact resistance:  $\leq 1 \text{ m}\Omega$
- it is recommended to crimp the contacts with crimping tools homologated by ILME (please see the crimping tool section 16A contacts, RCF2D and RCM2D series) on pages 705 - 741
- for max. current load see the connector inserts derating diagram below; for more information see page 28

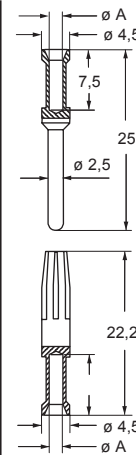
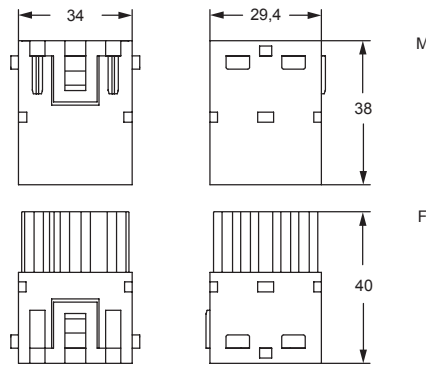

CX20 poles connector inserts  
Maximum current load derating diagram

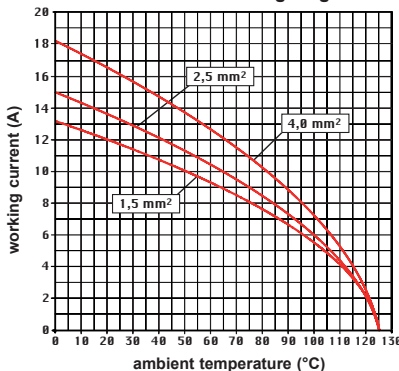

contacts side (front view)

side with reference arrow ▲

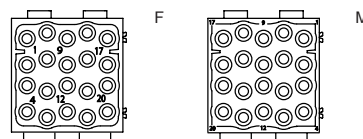

- 2 frame slots

RCF2D and RCM2D contacts

conductor section mm²	conductor slot $\varnothing A$ (mm)	conductors stripping length (mm)
0,14-0,37	0,9	7,5
0,5	1,1	7,5
0,75	1,3	7,5
1,0	1,45	7,5
1,5	1,8	7,5
2,5	2,2	7,5
3	2,55	7,5
4	2,85	7,5

The modular inserts must be installed in suitable frames, which are then mounted in traditional enclosures\* or in COB panel supports.

frames for modular units\*

page: 286

modular units, crimp connections

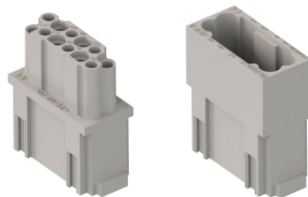

10A crimp contacts gold plated



**✍ RATING 250V**

**Q 10.000 MATINGS WITH HNM FRAMES AND HNM ENCLOSURES**

**Q 5.000 MATINGS WITH HNM FRAMES AND STANDARD ENCLOSURES, SINGLE LEVER**

\* enclosures: bulkhead mounting housings, high construction housings or high construction hoods

description

part No.

part No

without contacts (to be ordered separately)  
female inserts for female contacts  
male inserts for male contacts

**CX 12 DF**  
**CX 12 DM**

10A female contacts

0,14-0,37 mm <sup>2</sup>	AWG 26-22	identification No. 1
0,5 mm <sup>2</sup>	AWG 20	identification No. 2
0,75 mm <sup>2</sup>	AWG 18	identification No. ②
1 mm <sup>2</sup>	AWG 18	identification No. 3
1,5 mm <sup>2</sup>	AWG 16	identification No. 4
2,5 mm <sup>2</sup>	AWG 14	identification No. 5

**gold plated**

RDF2D 0.3
RDF2D 0.5
RDF2D 0.7
RDF2D 1.0
RDF2D 1.5
RDF2D 2.5

10A male contacts

0,14-0,37 mm <sup>2</sup>	AWG 26-22	identification No. 1
0,5 mm <sup>2</sup>	AWG 20	identification No. 2
0,75 mm <sup>2</sup>	AWG 18	identification No. ②
1 mm <sup>2</sup>	AWG 18	identification No. 3
1,5 mm <sup>2</sup>	AWG 16	identification No. 4
2,5 mm <sup>2</sup>	AWG 14	identification No. 5

RDM2D 0.3
RDM2D 0.5
RDM2D 0.7
RDM2D 1.0
RDM2D 1.5
RDM2D 2.5

- characteristics according to EN 61984:

**10A 160V 2,5kV 3**  
**10A 250V 4kV 2**

- certified
- rated voltage according to UL/CSA: 600V
- insulation resistance: ≥ 10 GΩ
- ambient temperature limit: -40 °C ... +125 °C
- made of self-extinguishing thermoplastic resin UL 94V-0
- mechanical life: ≥ 10.000 cycles
- contact resistance: ≤ 3 mΩ
- PCBs interface, refer to article CIF 2.4 on page 670
- **it is recommended to crimp the contacts with crimping tools homologated by ILME** (please see the crimping tool section 10A contacts, RDF2D and RDM2D series) on pages 705 - 741
- for max. current load see the connector inserts derating diagram below; for more information see page 28

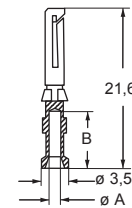
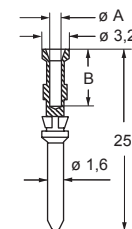
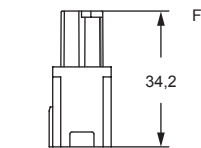
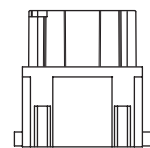
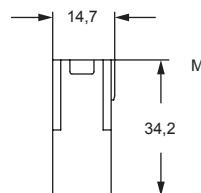
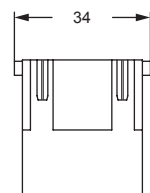

contacts side (front view)

side with reference arrow ▲

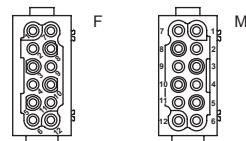

- 1 frame slot

**CX 12 poles connector inserts**  
**Maximum current load derating diagram**

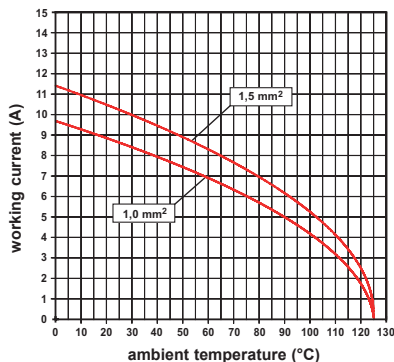

**RDF2D and RDM2D contacts**

conductor section mm <sup>2</sup>	conductor slot ø A (mm)	conductors stripping length B (mm)
0,14-0,37	0,9	8
0,5	1,1	8
0,75	1,3	8
1,0	1,45	8
1,5	1,8	8
2,5	2,2	6

MIXO - HNM



The modular inserts must be installed in suitable frames, which are then mounted in traditional enclosures or in COB panel supports.

frames for modular units

page: 286

modular units, crimp connections

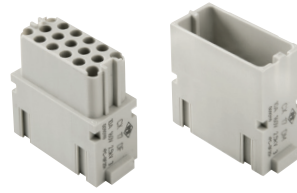

Q 10.000 MATINGS WITH HNM FRAMES AND HNM ENCLOSURES

Q 5.000 MATINGS WITH HNM FRAMES AND STANDARD ENCLOSURES, SINGLE LEVER

10A crimp contacts, gold plated



description	part No.	part No.
-------------	----------	----------

without contacts (to be ordered separately)  
female inserts for female contacts  
male inserts for male contacts

CX 17 DF  
CX 17 DM

10A female contacts

cross-section	AWG	identification No.
0,14-0,37 mm <sup>2</sup>	AWG 26-22	identification No. 1
0,5 mm <sup>2</sup>	AWG 20	identification No. 2
0,75 mm <sup>2</sup>	AWG 18	identification No. ②
1 mm <sup>2</sup>	AWG 18	identification No. 3
1,5 mm <sup>2</sup>	AWG 16	identification No. 4
2,5 mm <sup>2</sup>	AWG 14	identification No. 5

RDF2D 0.3
RDF2D 0.5
RDF2D 0.7
RDF2D 1.0
RDF2D 1.5
RDF2D 2.5

gold plated

10A male contacts

cross-section	AWG	identification No.
0,14-0,37 mm <sup>2</sup>	AWG 26-22	identification No. 1
0,5 mm <sup>2</sup>	AWG 20	identification No. 2
0,75 mm <sup>2</sup>	AWG 18	identification No. ②
1 mm <sup>2</sup>	AWG 18	identification No. 3
1,5 mm <sup>2</sup>	AWG 16	identification No. 4
2,5 mm <sup>2</sup>	AWG 14	identification No. 5

RDM2D 0.3
RDM2D 0.5
RDM2D 0.7
RDM2D 1.0
RDM2D 1.5
RDM2D 2.5

- characteristics according to EN 61984:

**10A 160V 2,5kV 3**  
**10A 250V 4kV 2**

- cULus (UL for USA and Canada),

- certified

- rated voltage according to UL/CSA: 250V

- insulation resistance: ≥ 10 GΩ

- ambient temperature limit: -40 °C ... +125 °C

- made of self-extinguishing thermoplastic resin UL 94V-0

- mechanical life: ≥ 10.000 cycles

- contact resistance: ≤ 3 mΩ

- it is recommended to crimp the contacts with crimping tools homologated by ILME (please see the crimping tool section 10A contacts, RDF2D and RDM2D series) on pages 705 - 741

- for max. current load see the connector inserts derating diagram below; for more information see page 28

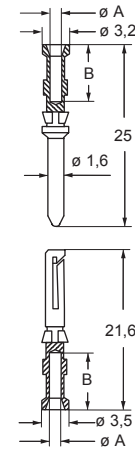
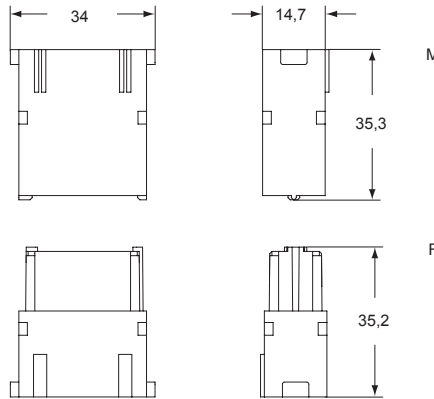

contacts side (front view)

side with reference arrow ▲

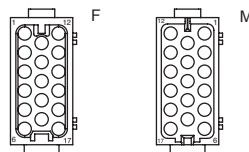

- 1 frame slot

RDF2D and RDM2D contacts

conductor section	conductor slot	conductors stripping length
mm <sup>2</sup>	ø A (mm)	B (mm)
0,14-0,37	0,9	8
0,5	1,1	8
0,75	1,3	8
1,0	1,45	8
1,5	1,8	8
2,5	2,2	6

CX 17 poles connector inserts  
Maximum current load derating diagram

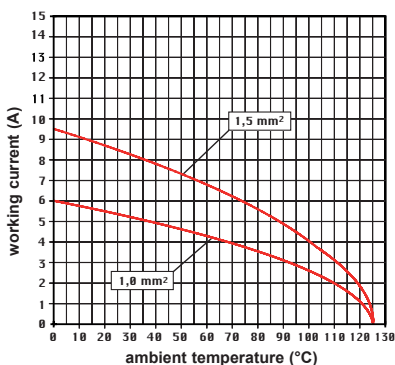

The modular inserts must be installed in suitable frames, which are then mounted in traditional enclosures\* or in COB panel supports.

frames for modular units\*

page:  
286

modular units,  
crimp connections

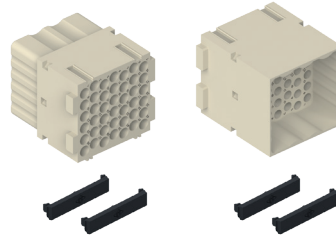

Q 10.000 MATINGS WITH HNM FRAMES AND HNM ENCLOSURES

Q 5.000 MATINGS WITH HNM FRAMES AND STANDARD ENCLOSURES, SINGLE LEVER

AVAILABLE MAY 2019

10A crimp contacts  
gold plated



\* enclosures: bulkhead mounting housings, high construction housings or high construction hoods

description

part No.

part No.

without contacts (to be ordered separately), supplied with 2 dedicated black coloured 2-slot sized lock-in tabs  
female inserts for female contacts  
male inserts for male contacts

CX 42 DF  
CX 42 DM

10A female contacts

0,14-0,37 mm <sup>2</sup>	AWG 26-22	identification No. 1
0,5 mm <sup>2</sup>	AWG 20	identification No. 2
0,75 mm <sup>2</sup>	AWG 18	identification No. ②
1 mm <sup>2</sup>	AWG 18	identification No. 3
1,5 mm <sup>2</sup>	AWG 16	identification No. 4
2,5 mm <sup>2</sup>	AWG 14	identification No. 5

RDF2D 0.3  
RDF2D 0.5  
RDF2D 0.7  
RDF2D 1.0  
RDF2D 1.5  
RDF2D 2.5

gold plated<sup>+</sup>

10A male contacts

0,14-0,37 mm <sup>2</sup>	AWG 26-22	identification No. 1
0,5 mm <sup>2</sup>	AWG 20	identification No. 2
0,75 mm <sup>2</sup>	AWG 18	identification No. ②
1 mm <sup>2</sup>	AWG 18	identification No. 3
1,5 mm <sup>2</sup>	AWG 16	identification No. 4
2,5 mm <sup>2</sup>	AWG 14	identification No. 5

RDM2D 0.3  
RDM2D 0.5  
RDM2D 0.7  
RDM2D 1.0  
RDM2D 1.5  
RDM2D 2.5

- characteristics according to EN 61984:

**10A 150V 2,5kV 3**

- cURus, CSA, CQC, DNV-GL, BV, EAC pending
- rated voltage according to UL/CSA: 250V
- insulation resistance:  $\geq 10 \text{ G}\Omega$
- ambient temperature limit:  $-40 \text{ }^\circ\text{C} \dots +125 \text{ }^\circ\text{C}$
- made of self-extinguishing thermoplastic resin UL 94V-0
- mechanical life:  $\geq 10.000$  cycles
- contact resistance:  $\leq 3 \text{ m}\Omega$
- it is recommended to crimp the contacts with crimping tools homologated by ILME (please see the crimping tool section 10A contacts, RDF2D and RDM2D series) on pages 705 - 741

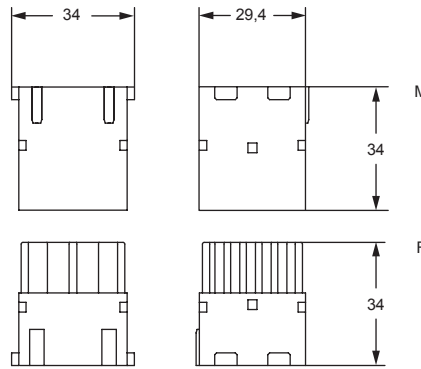

contacts side (front view)

rear view, side with reference arrow ▲

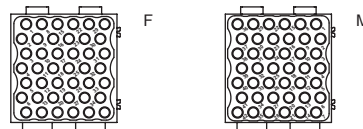

- 2 frame slots

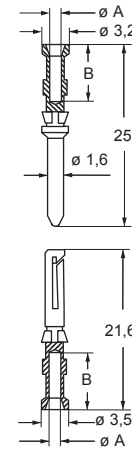

RDF2D and RDM2D contacts

conductor cross-sectional area mm <sup>2</sup>	conductor slot $\varnothing A$ (mm)	conductor stripping length B (mm)
0,14-0,37	0,9	8
0,5	1,1	8
0,75	1,3	8
1,0	1,45	8
1,5	1,8	8
2,5	2,2	6

<sup>+</sup> for basic or high thickness gold plating, please refer to page 480 of CN.16 catalogue





enclosures size:		page:
"44.27"	HNM	592 - 593
	C-TYPE IP65/IP66, single lever	387 - 392
	V-TYPE IP65/IP66, single lever	444 - 447
	E-Xtreme® corrosion proof	530-531, 542, 550-551
"57.27"	HNM	594 - 595
	C-TYPE IP65/IP66, single lever	393 - 401
	V-TYPE IP65/IP66, single lever	448 - 453
	E-Xtreme® corrosion proof	532 - 533, 543, 552 - 553
"77.27"	HNM	596 - 597
	C-TYPE IP65/IP66, single lever	402 - 411
	V-TYPE IP65/IP66, single lever	454 - 458
	E-Xtreme® corrosion proof	534 - 535, 544, 554 - 555
"104.27"	HNM	598 - 599
	C-TYPE IP65/IP66, single lever	412 - 423
	V-TYPE IP65/IP66, single lever	459 - 463
	E-Xtreme® corrosion proof	536 - 537, 545, 556 - 557
"77.62"	C-TYPE IP65/IP66, single lever	424 - 429
	E-Xtreme® corrosion proof	546
"104.62"	C-TYPE IP65/IP66, single lever	430
	E-Xtreme® corrosion proof	547

C-TYPE and V-TYPE 2-lever versions cannot be used to reach 5.000 matings.

frames for modular units with lock-in tabs (included)

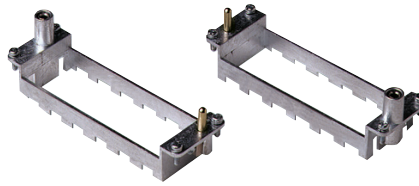

lock-in tabs



Q 10.000 MATINGS WITH HNM FRAMES AND HNM ENCLOSURES

Q 5.000 MATINGS WITH HNM FRAMES AND STANDARD ENCLOSURES, SINGLE LEVER

description	part No.	part No.
-------------	----------	----------

frames for modular units (module lock-in tabs included)  
 for 2 modular units - for housing size 44.27  
 for 3 modular units - for housing size 57.27  
 for 4 modular units - for housing size 77.27 and 77.62  
 for 6 modular units - for housing size 104.27 and 104.62

type for hoods	type for housings
RX 02 TM	RX 02 TF
RX 03 TM	RX 03 TF
RX 04 TM	RX 04 TF
RX 06 TM	RX 06 TF

lock-in tabs (6 units) dividable

CX CFM

- die-cast zinc alloy frames
- protective earth (PE)
- possibility of mounting female and male modular units on the same frame
- frames supplied with lock-in tabs to attach units
- polarisation on frames
- coding pins CR..CX

Polarisation of frames with relative identification letters and couplings

frame for hoods <sup>1)</sup> frames for housings <sup>1)</sup>

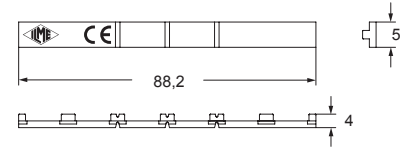
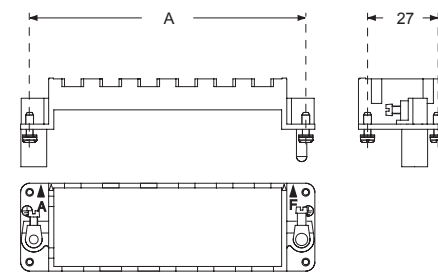
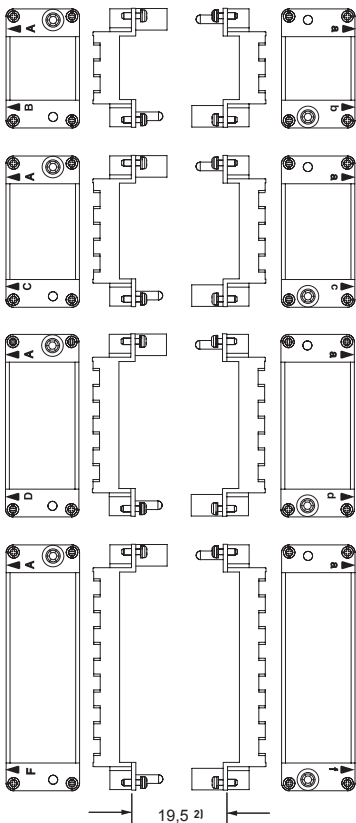

part No.	A (mm)	for housings size
RX 02 TM / TF	44	44,27
RX 03 TM / TF	57	57,27
RX 04 TM / TF	77,5	77,27 and 77,62
RX 06 TM / TF	104	104,27 and 104,62

Earth terminal

- large: for cables from 4-6 mm<sup>2</sup>, AWG 12-10
- small: for cables from 1-2,5 mm<sup>2</sup>, AWG 18-14

position of modules (contact side view)

side with reference arrow ▲

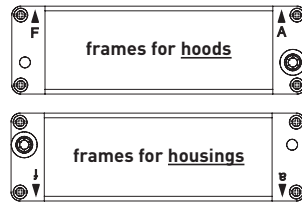

side with reference arrow ▼

- <sup>1)</sup> Warning: The module support frames are marked:  
 - FOR HOODS: **upper-case** A-B, A-C, A-D and A-F  
 - FOR HOUSINGS: **lower-case** a-b, a-c, a-d and a-f

Positioning the modules in the frames according to the respective letters is ensuring the specular assembly of modules, for which the hood will be coupled correctly to the housing.

<sup>2)</sup> Distance for:

- electric and fibre optic contacts: max 21 mm
- pneumatic contacts: max 20,5 mm

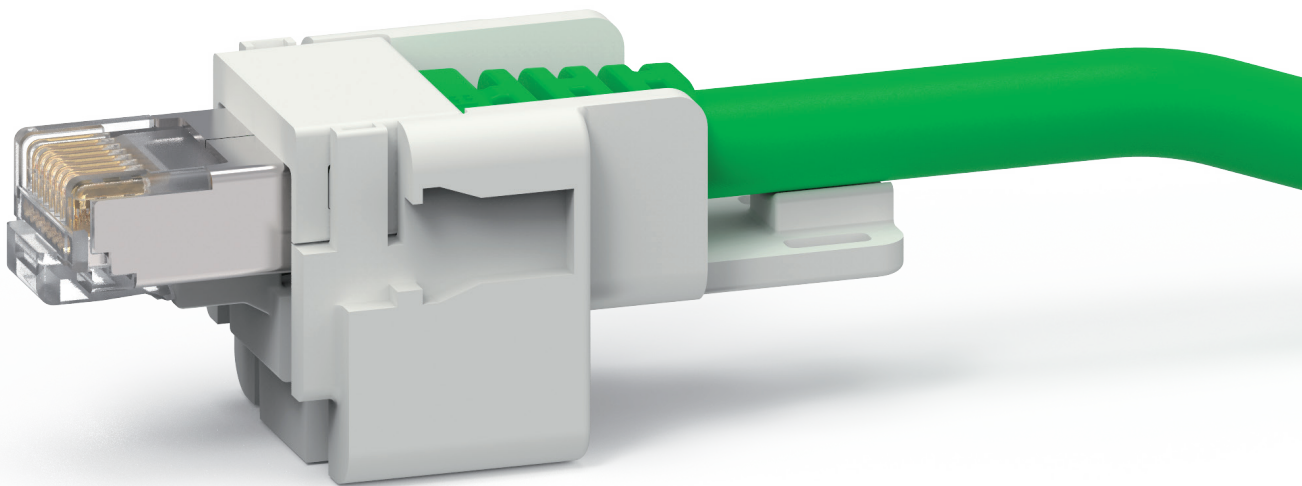

# CJ RJ45 connector

enclosures:	page:
size "21.21"	
insulating type (CK IN, CKG/MKG VN/VAN)	346 - 348
metallic type (CKAX I, CKAG/MKAG V/VA)	354 - 355-
IP68 (CKG I, CKG/MKG V)	628 - 631

## adaptor for RJ45 connectors

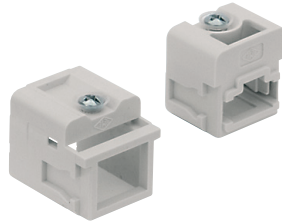

## RJ45 connectors

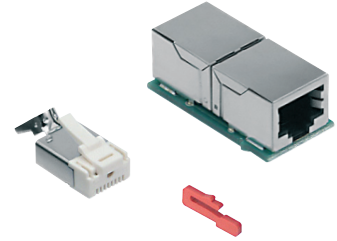

description	part No.	part No. data contacts only	part No. data contacts/+2 power contacts
without RJ45 connector (to be ordered separately) adaptor for RJ45 female connector in fixed enclosures	<b>CJ KF</b>		
RJ45 coupler jack with 8 data contacts		<b>CX 8 JF *</b>	
RJ45 coupler jack with 8 data contacts/2 power contacts			<b>CX 8/2 JF *</b>
without RJ45 connector (to be ordered separately) adaptor for RJ45 male connector <sup>1)</sup>	<b>CJ KM</b>		
RJ45 plug with 4 data contacts		<b>CX 4 JM</b>	
RJ45 plug with 4 data contacts/2 power contacts			<b>CX 4/2 JM</b>
RJ45 plug with 6 data contacts/2 power contacts			<b>CX 6/2 JM</b>
RJ45 plug with 8 data contacts		<b>CX 8 JM</b>	
RJ45 plug, 4 data contacts <b>cat. 5e ProfiNET®</b>		<b>CX 4E JM</b>	

<sup>1)</sup> to be used with hoods

### RJ45 connector features:

- RJ45 insert, Class 5 Ethernet
- rated current: 2,1A at 70 °C
- rated voltage: 50VDC / 35VAC
- IDC terminals:
- for 0,22 mm<sup>2</sup> (AWG 24/7) data contacts **CX 4 JM**
- for 0,14 mm<sup>2</sup> (AWG 26/7) or 0,22 mm<sup>2</sup> (AWG 24/7) data contacts **CX 4/2 JM**
- for 0,34 mm<sup>2</sup> (AWG 22/7) or 0,38 mm<sup>2</sup> (AWG 22/19) power contacts
- for 0,14 mm<sup>2</sup> (AWG 26/7) data contacts **CX 6/2 JM**
- for 0,25 mm<sup>2</sup> (AWG 23/19) power contacts
- for 0,14 mm<sup>2</sup> (AWG 26/7) data contacts **CX 8 JM**
- for 0,34 mm<sup>2</sup> (AWG 22/7) data contacts **CX 4E JM**
- /7 = 7-strands wire
- /19 = 19-strands wire
- Ø<sub>max</sub> insulating conductors 1 mm (data), 1,4 mm (power and CX 4E JM)
- Ø<sub>max</sub> complete cable 7 mm (CX 8 JM: 6,9 mm)
- temperature range: from -40°C to 120 °C
- nickel plated brass screening
- insert coding pin for RJ45 adapters (optional)\*: **CR KC**
- \* Optional four coding positions CR KC insert coding pin (4 pins required for each connector coupling).
- self-extinguishing properties: to UL 94V-0
- crimp pliers: **CJPZ Y**
- screened cable stripper: **CJST**
- for crimping a male connector, see the crimp tool section page 735

- cULus (UL for USA and Canada) certified

### CR KC insert coding pin

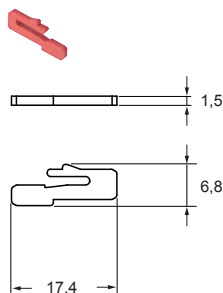

### CJ KF, CJ KM

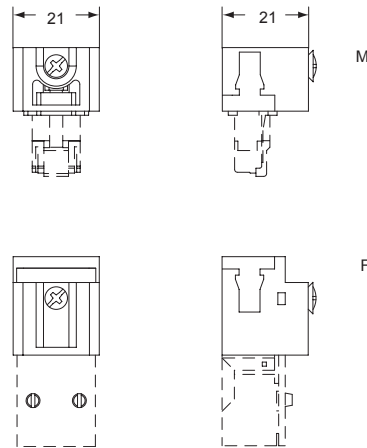

contacts side (front view)

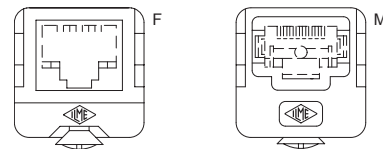

\* 4-pole version on request, part No. **CX 4 JF** and **CX 4/2 JF** with "crossover" link

### CX 4 JF, CX 4/2 JF, CX 8 JF, CX 8/2 JF

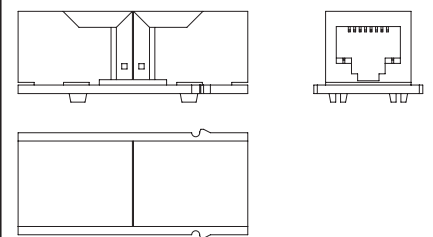

### CX 4 JM, CX 4E JM, CX 4/2 JM, CX 6/2 JM, CX 8 JM

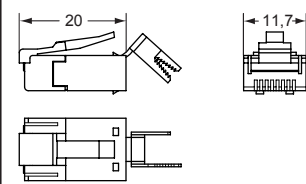

### How to use CR KC coding pins (cannot be used with IP68 enclosures)

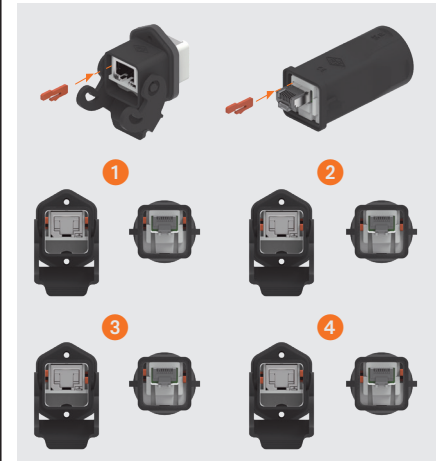

# CJZ RJ45 connector

- IP66/IP67/IP69 degree of protection (EN 60529)
- insert RJ45, CAT. 5 Ethernet
- rated current: 2.1A at 70 °C
- rated voltage: 50V DC / 35V AC
- temperature limit: -40 °C, +120 °C
- nickel-plated brass screening
- insert coding pin: **CR KC**
- self-extinguishing: UL 94V-0
- insulating enclosures in black self-extinguishing thermoplastic material
- hoods with cable gland
- female insert with two connected entries

IP66 / IP67 connector in bulkhead housing, female inserts

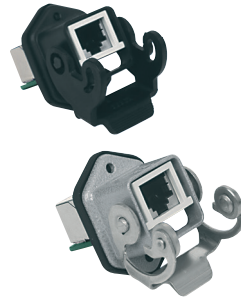

patch cord with 2 RJ45 connectors, male inserts



description	part No.	part No.	(L) metre
connector in insulating enclosure and insert with 8 data contacts	<b>CJZ 8 IN</b>		
connector in metal enclosure and insert with 8 data contacts	<b>CJZA 8 I</b>		
RJ45 connector 8 data contacts, in insulating enclosure		<b>CWK 2 J2M8</b>	2
		<b>CWK 5 J2M8</b>	5
		<b>CWK 10 J2M8</b>	10
RJ45 connector 8 data contacts, in metal enclosure		<b>CWKA 2 J2M8</b>	2
		<b>CWKA 5 J2M8</b>	5
		<b>CWKA 10J2M8</b>	10

panel cut-out for bulkhead mounting housings

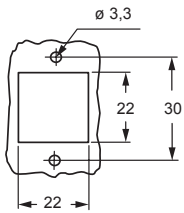

**CR KC**  
insert coding pin

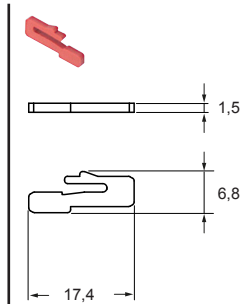

How to use CR KC coding pins  
(cannot be used with IP68 enclosures)

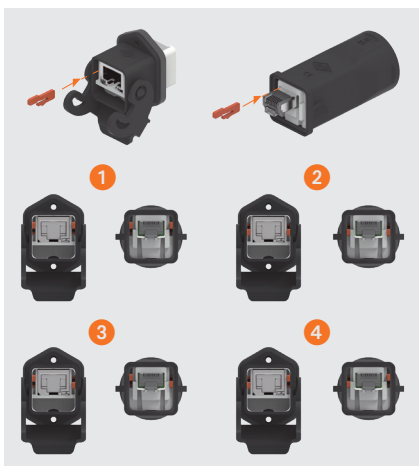

**CJZ IN**

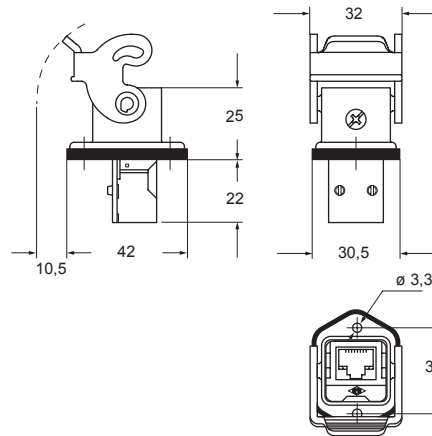

**CJZA I**

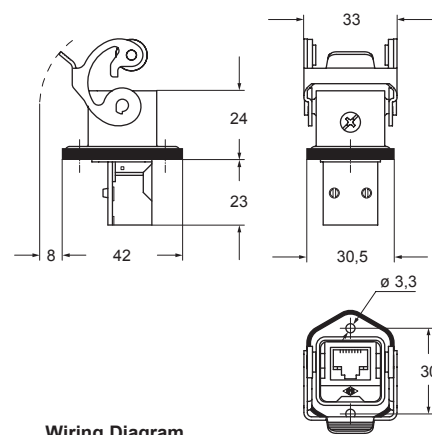

Wiring Diagram

1	1
2	2
3	3
4	4
5	5
6	6
7	7
8	8
VS	VS

**CWK J2M8 and CWKA J2M8**

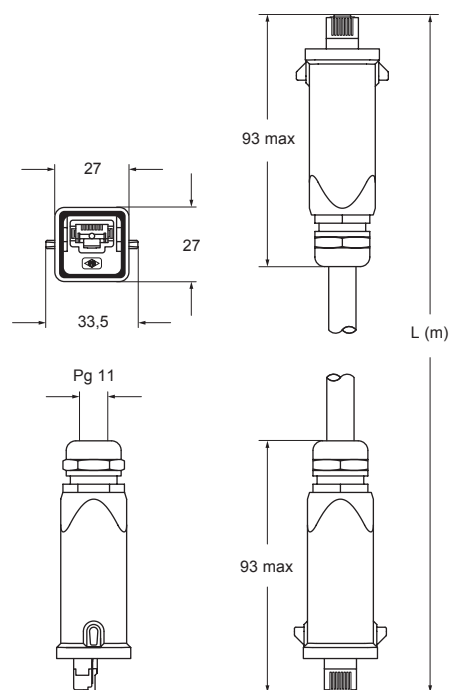

Wiring Diagram

1	1
2	2
3	3
4	4
5	5
6	6
7	7
8	8
VS	VS

DATA CONNECTORS

# CYG RJ45 connector

Allows two complete portable RJ45 connectors to be joined, IP65/IP67/IP69 version

## insulated version coupling, for RJ45 connectors



## metal version coupling, for RJ45 connectors



description	part No. data contacts only	part No. data contacts/+2 power contacts	part No. data contacts only	part No. data contacts/+2 power contacts
RJ45 coupler jack within housings, 8 data contacts	<b>CYG 8 JF *</b>	<b>CYG 8/2 JF *</b>	<b>CYG 8 JFA *</b>	<b>CYG 8/2 JFA *</b>
RJ45 coupler jack within housings, 8 data contacts/2 power contacts				
RJ45 coupler jack within housings, 8 data contacts				
RJ45 coupler jack within housings, 8 data contacts/2 power contacts				

**RJ45 connector features:**

- RJ45, Class 5 connector
- nominal current: 2.1A at 70 °C
- nominal voltage: 50VDC / 35VAC
- temperature range: from -40 °C to +120 °C
- nickel plated brass screening
- insert coding pin: **CR KC**
- self-extinguishing properties: UL 94V-0
- die cast zinc alloy metal enclosures
- black self-extinguishing thermoplastic insulated enclosures.

\* 4-pole version on request, part No. **CYG 4 JF** and **CYG 4/2 JF** with "crossover" link

**CYG 4 JF, CYG 4/2 JF, CYG 8 JF, CYG 8/2 JF**

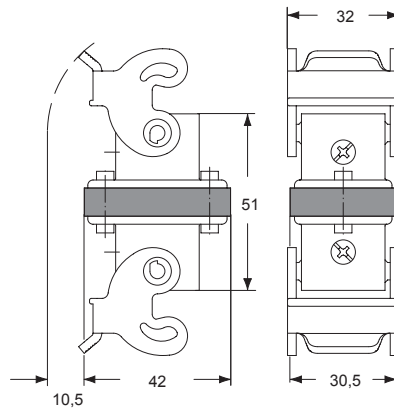

contacts side (front view)

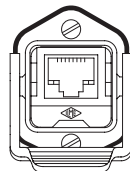

\* 4-pole version on request, part No. **CYG 4 JFA** and **CYG 4/2 JFA** with "crossover" link

**CYG 4 JFA, CYG 4/2 JFA, CYG 8 JFA, CYG 8/2 JFA**

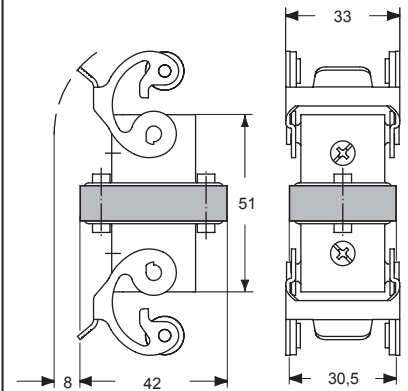

contacts side (front view)

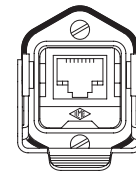

# CJK adapters 1 seat for RJ45 connector Cat. 6 Class E<sub>A</sub>

enclosures: size "21.21"	page:
insulating type (CK IN, CKG/MKG VN/VAN *)	346 - 348
metallic type (CKAX I, CKAX/MKAX IAP/AP/VG) (CKAG/MKAG V/VA *)	349 and 354 355
IP68 (CKG I, CKG/MKG IAP, CKG/MKG V)	628 - 631

\* angled enclosures cannot be used with CX 8 J6IM

- characteristics according to EN 61984:
- 1A 50V 0,8kV 3**
- cULus (UL for USA and Canada) certified
- insulation resistance:  $\geq 10$  G $\Omega$
- made of self-extinguishing thermoplastic resin UL 94V-0
- mechanical life:  $\geq 500$  cycles
- temperature range: from -40 °C to +70 °C
- we recommend to fix the cable with cable tie

adapters for RJ45 male connectors,  
RJ45 female-female connectors

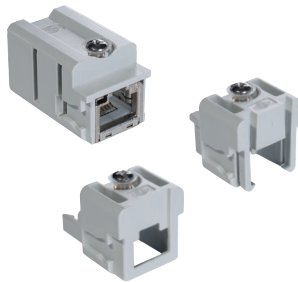

RJ45 male connectors,  
crimp and IDC termination

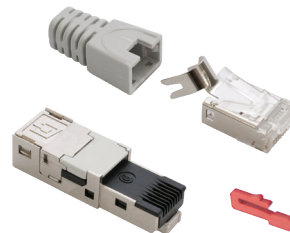

Watch  
our  
online  
tutorial



description	part No.	part No.
socket insert with 1 RJ45 female connector plug inserts for 1 RJ45 male crimp connector, 8 data contacts (without RJ45 connector, to be ordered separately)	<b>CJK 8FT</b> <b>CJK 8MT</b>	
plug insert for 1 RJ45 male IDC connector, 8 data contacts (without RJ45 connector, to be ordered separately)	<b>CJK 8IMT</b>	
RJ45 male crimp connector, 8 data contacts		<b>CX 8 J6M</b>
RJ45 male IDC connector, 8 data contacts		<b>CX 8 J6IM</b>

- CJK 8FT technical data:**
- RJ45 female insert, Cat. 6 Class E<sub>A</sub>
  - shielding housing: zinc diecast
  - housing finish: nickel-plated
  - current carrying capacity at 50 °C: 1A
  - adequate for Power over Ethernet: PoE according to IEEE 802.3af
  - connectors: IEC 60603-7-5
  - adequate for 10 Gigabit Ethernet: 10 Gigabit Ethernet acc. to IEEE 802.3an
  - custom-designed cabling systems: PROFINET Installation Guideline
  - generic cabling systems: ANSI/TIA/EIA-568-C.2
  - ISO/IEC 11801
  - EN50173-1
  - ISO/IEC 24702
  - EN 61918
  - class E<sub>A</sub> (channel): ISO/IEC 11801, EN 50173-1

- CX 8 J6M technical data:**
- RJ45 male crimp connectors Cat. 6<sub>A</sub>
  - crimp pliers: **CJPZ T**
  - screened cable stripper: **CJST**
  - Cu-conductor diameter
  - solid: 0,40 - 0,51 mm (AWG 26/1 - 24/1)
  - stranded: 0,46 - 0,61 mm (AWG 27/7 - 24/7)
  - insulation diameter: 0,85 - 1,05 mm
  - cable diameter: 5,0 - 7,0 mm
  - connectors: IEC 60603-7-51
  - 10 Gigabit Ethernet acc. to IEEE 802.3an: adequate for 10 Gigabit Ethernet
  - category 6<sub>A</sub>: ISO/IEC 11801; EN 50173-1
  - class E<sub>A</sub>: ISO/IEC 11801; EN 50173-1
  - category 6<sub>A</sub>: ANSI/TIA/EIA-568-C.2

- CX 8 J6IM technical data:**
- RJ45 male IDC connectors Cat. 6 Class E<sub>A</sub>
  - Cu-conductor diameter
  - solid: 0,41 - 0,64 mm (AWG 26/1 - 22/1)
  - stranded: 0,48 - 0,76 mm (AWG 26/7 - 22/7)
  - insulation diameter: 0,85 - 1,6 mm
  - cable diameter: 5,5 - 8,5 mm
  - connectors: IEC 60603-7-5
  - category 6<sub>A</sub>: ISO/IEC 11801; DIN EN 50173-1
  - wrenches pliers for CX 8 J6IM: **CJPW K**
  - 10 Gigabit Ethernet acc. to IEEE 802.3an: adequate for 10 Gigabit Ethernet
  - class E<sub>A</sub>: ISO/IEC 11801; EN 50173-1
  - category 6: ANSI/TIA/EIA-568-C.2
  - custom-designed cabling systems: according to PROFINET Installation Guideline

**CR KC**  
insert coding pin

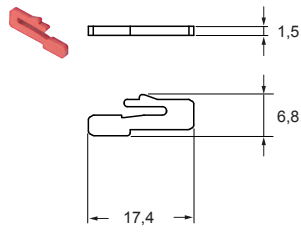

**CJK 8FT**

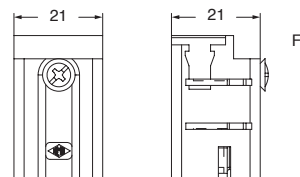

**Female-Female**



**CJK 8MT**<sup>1)</sup>

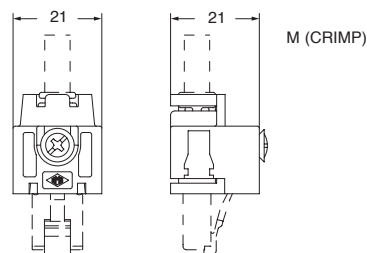

<sup>1)</sup> to be used with hoods

**CJK 8IMT**<sup>1)</sup>

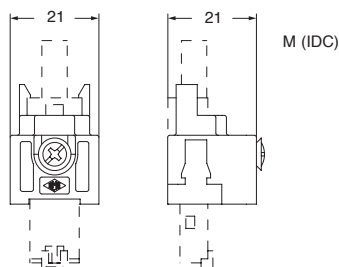

<sup>1)</sup> to be used with hoods

**CX 8 J6M** (can be used with CJK 8MT)

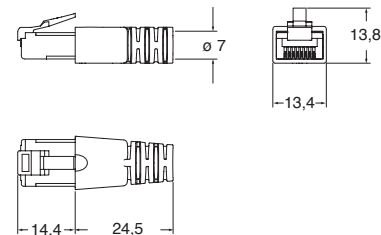

**CX 8 J6IM** (can be used with CJK 8IMT)

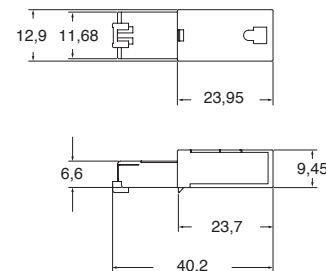

**How to use CR KC coding pins**  
(cannot be used with IP68 enclosures)





# CW RJ45 patch cord

with 2 RJ45 male connectors



description	part No.	(L) meter
RJ45 male connector with 8 data contacts	<b>CW 1 J2M87</b>	1
	<b>CW 2 J2M87</b>	2
	<b>CW 3 J2M87</b>	3
	<b>CW 5 J2M87</b>	5
	<b>CW 7.5J2M87</b>	7,5
	<b>CW 10 J2M87</b>	10
	<b>CW 15 J2M87</b>	15

**RJ45 patch cord technical data:**  
 - S/FTP Cat. 7 PUR  
 - temperature range: from -40 °C + +75 °C  
 - nickel plated brass screening  
 - green RAL 6018 colour

**Can be used with:**  
 - MIXO RJ45 CX 01 J8M male inserts  
 - CJK 8MT adaptors

**CJK 8MT male assembly**

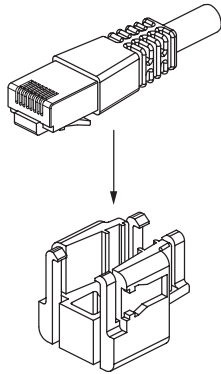

**CJK 8FT to be used in VG or IAP enclosures with male crimp version**

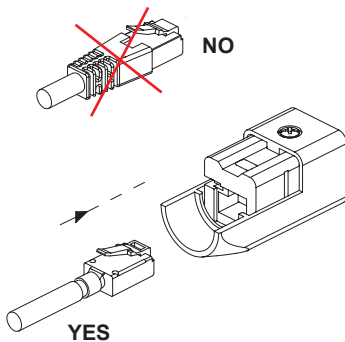

**CW...J2M87**

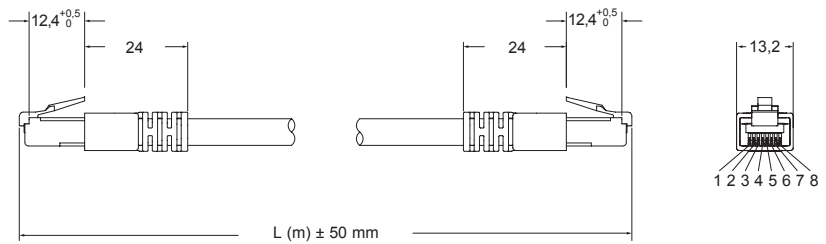

**Wiring Diagram**

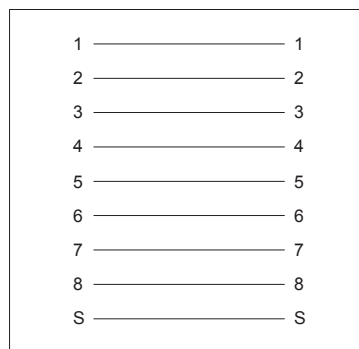

# CJK adapters 1 seat for RJ45 IDC connector Cat. 6 Class E<sub>A</sub>

enclosures: page:  
 size "21.21"  
 insulating type 346 - 348  
 (CK IN, CKG/MKG VN/VAN \*)  
 metallic type 349 and 354  
 (CKAX I, CKAX/MKAX IAP/AP/VG) 355  
 (CKAG/MKAG V/VA \*)  
 IP68 628 - 631  
 (CKG I, CKG/MKG IAP, CKG/MKG V)

\* angled enclosures cannot be used with CX 8 J6IM

- characteristics according to EN 61984:

- 1A 50V 0,8kV 3
- cULus (UL for USA and Canada) certified
- insulation resistance:  $\geq 10$  G $\Omega$
- made of self-extinguishing thermoplastic resin UL 94V-0
- mechanical life:  $\geq 500$  cycles
- temperature range: from -40 °C to +70 °C
- we recommend to fix the cable with cable tie

adapters for RJ45 male connectors,  
 RJ45 female - cable IDC connectors

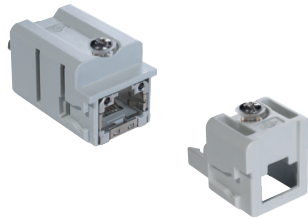

RJ45 male connectors,  
 IDC termination



Watch  
 our  
 online  
 tutorial

description	part No.	part No.
socket insert with 1 RJ45 female-IDC connector contact coding according to <b>T568A</b>	<b>CJK 8IFT</b>	
socket insert with 1 RJ45 female-IDC connector contact coding according to <b>T568B</b>	<b>CJK 8B IFT</b>	
socket insert with 1 RJ45 female-IDC connector contact coding according to <b>PROFINET</b>	<b>CJK 8P IFT</b>	
plug insert for 1 RJ45 male IDC connector, 8 data contacts (without RJ45 connector, to be ordered separately)	<b>CJK 8IMT</b>	
RJ45 male IDC connector, 8 data contacts		<b>CX 8 J6IM</b>

**CJK 8IFT, CJK 8B IFT, CJK 8P IFT technical data:**

- RJ45 female insert, Cat. 6<sub>A</sub>
- Cu-conductor diameter  
 solid: 0,40 - 0,64 mm (AWG 26/1 - 22/1)  
 stranded: 0,48 - 0,76 mm (AWG 26/7 - 22/7)
- insulation diameter: 0,85 - 1,6 mm (0,034 - 0,063 in.)
- shielding housing: zinc diecast
- housing finish: nickel-plated
- current carrying capacity at 50 °C: 1A
- adequate for Power over Ethernet:  
 PoE according to IEEE 802.3af
- connectors: IEC 60603-7-5
- adequate for 10 Gigabit Ethernet:  
 10 Gigabit Ethernet acc. to IEEE 802.3an
- custom-designed cabling systems: PROFINET  
 Installation Guideline
- generic cabling systems:  
 ANSI/TIA/EIA-568-C.2  
 ISO/IEC 11801  
 EN50173-1  
 ISO/IEC 24702  
 EN 61918
- class E<sub>A</sub> (channel): ISO/IEC 11801, EN 50173-1

**CJK 8IFT**

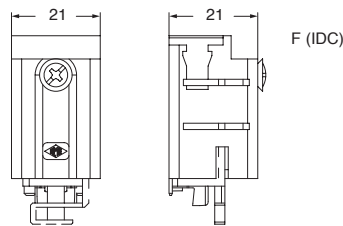

Female-Cable IDC



**CX 8 J6IM (can be used with CJK 8IMT)**

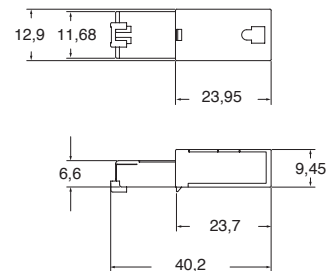

**CX 8 J6IM technical data:**

- RJ45 male IDC connectors Cat. 6 Class E<sub>A</sub>
- Cu-conductor diameter  
 solid: 0,41 - 0,64 mm (AWG 26/1 - 22/1)  
 stranded: 0,48 - 0,76 mm (AWG 26/7 - 22/7)
- insulation diameter: 0,85 - 1,6 mm
- cable diameter: 5,5 - 8,5 mm
- connectors: IEC 60603-7-5
- category 6<sub>A</sub>: ISO/IEC 11801; DIN EN 50173-1
- wrenches pliers for CX 8 J6IM: **CJPW K**
- 10 Gigabit Ethernet acc. to IEEE 802.3an:  
 adequate for 10 Gigabit Ethernet
- class E<sub>A</sub>: ISO/IEC 11801; EN 50173-1
- category 6: ANSI/TIA/EIA-568-C.2
- custom-designed cabling systems:  
 according to PROFINET Installation Guideline

**CJK 8IMT <sup>1)</sup>**

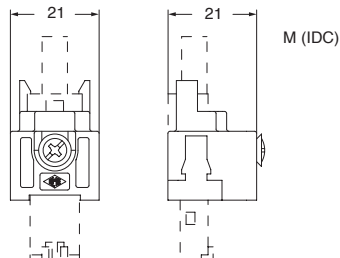

<sup>1)</sup> to be used with hoods

**CR KC insert coding pin**

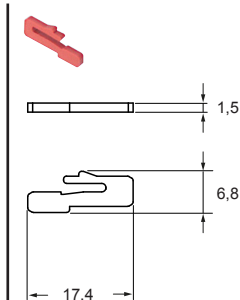

**How to use CR KC coding pins (cannot be used with IP68 enclosures)**

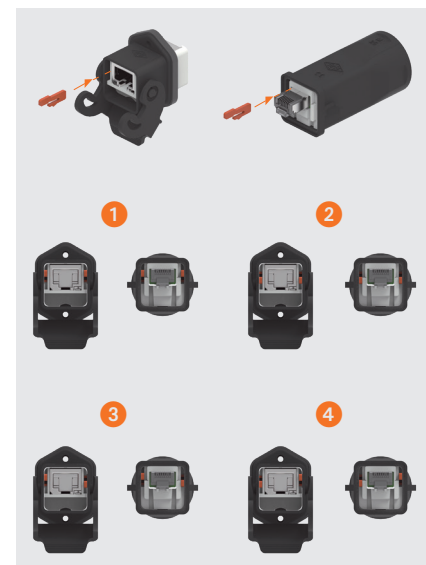

DATA CONNECTORS

# CW - CWC connecting cables for MIXO RJ45 CAT. 6<sub>A</sub>

with 2xRJ45 CAT. 6<sub>A</sub> cable plug

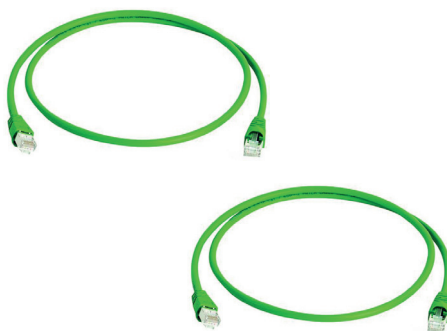

M12x1 CAT. 7 cable plug black



description	part No.	(L) meter	part No.	(L) meter	part No.	(L) meter
<b>S/FTP CAT. 6A cable</b> 4x2xAWG 27/7 (PUR) * - SHIELEDDED * chemical resistant cable jacket Colour outer jacket green	<b>CW J6 1M</b>	1				
	<b>CW J6 2M</b>	2				
	<b>CW J6 3M</b>	3				
	<b>CW J6 5M</b>	5				
	<b>CW J6 7.5M</b>	7,5				
	<b>CW J6 10M</b>	10				
	<b>CW J6 15M</b>	15				
<b>S/FTP CAT. 6A cable</b> 4x2xAWG 27/7 (PVC) - SHIELEDDED Colour outer jacket green			<b>CWC J6 1M</b>	1		
			<b>CWC J6 2M</b>	2		
			<b>CWC J6 3M</b>	3		
			<b>CWC J6 5M</b>	5		
			<b>CWC J6 7.5M</b>	7,5		
			<b>CWC J6 10M</b>	10		
		<b>CWC J6 15M</b>	15			
<b>Over moulded IP67 to RJ45 plug crimp IP20</b> <b>S/FTP CAT. 7 cable</b> 4x2xAWG 26/7 (PUR) * * chemical resistant cable jacket Colour outer jacket green			<b>CW XJ0.5M</b>	0,5		
			<b>CW XJ1M</b>	1		
			<b>CW XJ2M</b>	2		
			<b>CW XJ3M</b>	3		
			<b>CW XJ5M</b>	5		
			<b>CW XJ7.5M</b>	7,5		
		<b>CW XJ10M</b>	10			

DATA CONNECTORS

**CW - CWC connecting cables for MIXO RJ45 CAT. 5**

with 2xRJ45 CAT. 5 cable plug

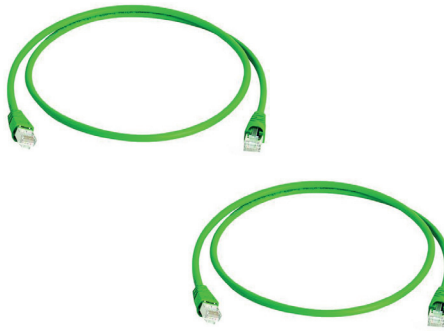

DATA CONNECTORS

description	part No.	(L) meter	part No.	(L) meter
<b>SF/UTP CAT. 5</b> 4x2xAWG 26/7 (PUR) * - SHIELDED * chemical resistant cable jacket Colour outer jacket green	<b>CW J5 1M</b>	1		
	<b>CW J5 2M</b>	2		
	<b>CW J5 3M</b>	3		
	<b>CW J5 5M</b>	5		
	<b>CW J5 7.5M</b>	7,5		
	<b>CW J5 10M</b>	10		
	<b>CW J5 15M</b>	15		
<b>SF/UTP CAT. 5</b> 4x2xAWG 26/7 (PVC) - SHIELDED Colour outer jacket green			<b>CWC J5 1M</b>	1
			<b>CWC J5 2M</b>	2
			<b>CWC J5 3M</b>	3
			<b>CWC J5 5M</b>	5
			<b>CWC J5 7.5M</b>	7,5
			<b>CWC J5 10M</b>	10
			<b>CWC J5 15M</b>	15

# CWH connecting cables for MIXO RJ45 CAT. 6<sub>A</sub> - CAT. 5<sub>e</sub>

with 2xRJ45 CAT. 6<sub>A</sub> cable plug



with 2xRJ45 CAT. 5<sub>e</sub> cable plug



description	part No.	(L) meter	part No.	(L) meter	part No.	(L) meter
<b>CAT. 6<sub>A</sub> wiring 1:1 cable</b> S/FTP (LSHZ) - SHIELDED Colour outer jacket green	<b>CWH J6 0.25M</b>	0,25				
	<b>CWH J6 0.5M</b>	0,5				
	<b>CWH J6 1M</b>	1				
	<b>CWH J6 2M</b>	2				
	<b>CWH J6 3M</b>	3				
	<b>CWH J6 5M</b>	5				
	<b>CWH J6 7.5M</b>	7,5				
	<b>CWH J6 10M</b>	10				
	<b>CWH J6 15M</b>	15				
<b>1x90° - 1x180° cable boot</b> <b>CAT. 6<sub>A</sub> wiring 1:1 cable</b> S/FTP (LSHZ) - shielded Colour outer jacket green			<b>CWH J6 0,5MA</b>	0,5		
			<b>CWH J6 1MA</b>	1		
			<b>CWH J6 2MA</b>	2		
			<b>CWH J6 3MA</b>	3		
			<b>CWH J6 5MA</b>	5		
			<b>CWH J6 7.5MA</b>	7,5		
			<b>CWH J6 10MA</b>	10		
<b>CAT. 5<sub>e</sub> wiring 1:1 cable</b> S/FTP (LSHZ) - SHIELDED Colour outer jacket green					<b>CWH JE 0.5M</b>	0,5
					<b>CWH JE 1M</b>	1
					<b>CWH JE 2M</b>	2
					<b>CWH JE 3M</b>	3
					<b>CWH JE 5M</b>	5
					<b>CWH JE 7.5M</b>	7,5
				<b>CWH JE 10M</b>	10	
				<b>CWH JE 15M</b>	15	

## CJK 8M

## TECHNICAL FEATURES

- **CJK 8M** adapter insert size "21.21" for placing an RJ45 plug (male connector) of a pre-assembled patch cord into a **M25** size "21.21" top cable entry hood, either metal or insulating;
- it allows a **truly "universal"** use thanks to the possibility to install virtually any RJ45 patch cord plugs available on the market (of any Category: Cat. 5, 5e, 6, 6A, 7, or 8) inside the growing range of size "21.21" top entry hoods with glued gasket, **without any disassembly of the patch cord**. A straightforward smart solution, all the more so if compared with more complex and expensive solutions;
- the **proprietary ILME design** of this adapter foresees a **two-part insulating carrier** (the first part acting as **carrier**, the second as **latch**) that can quickly and easily make captive the RJ45 plug (male connector), the assembly is then introduced in the relevant "21.21" M25 top entry hood and fastened to it by the usual screw;
- a **metallic** (nickel plated brass) **or insulating** (light grey or black colour) **M25 cable gland** with suitable internal diameter to let the patch cord RJ45 plug pass-through **is separately available**;
- the **special sealing gasket**, provided with the RJ45 adapter **CJK 8M**, is **longitudinally cut** on its flank and must be applied over the cable to increase its diameter in the portion to introduce in the cable gland sealing, according to instructions;

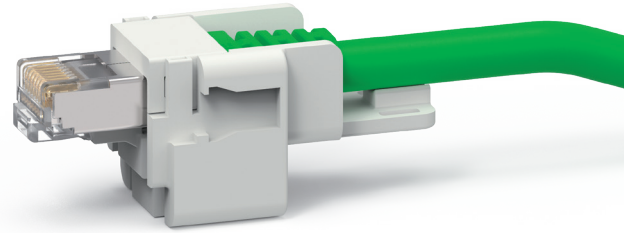

- suitable for the combination of an RJ45 patch cord with one or both RJ45 plug extremities mounted inside suitable size "21.21" *insulating or metal* M25 top entry hood with glued gasket, with an RJ45 jack counterpart (female connector), e.g. a **CJ KF** adapter combined with the relevant female/female RJ45 connector **CX 8 JF** or **CX 8/2 JF** (4-way version **CX 4 JF** or 4/2-way version **CX 4/2 JF** are available upon request), mounted inside a corresponding counterpart hood or housing with locking lever size "21.21";
- optional four coding positions with **CR KC** insert coding pin (4 pins required for each connector coupling).



# CJK 8M

enclosures:  
size "21.21"

page:

MKG V25  
MKG VN25  
MKAG V25

348  
348  
353

## RJ45 universal patch cord adapter

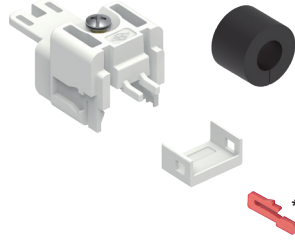

## M25 cable gland



description	part No	part No.	entry M
universal patch cord adapter	<b>CJK 8M</b>		
insert coding pin for RJ45 adapters (optional) *	<b>CR KC</b>		
plastic cable gland, light grey (RAL 7035)		<b>AW M25IJ</b>	25
plastic cable gland, black (RAL 9005)		<b>AW M25INJ</b>	25
nickel plated brass cable gland		<b>AW M25PJ</b>	25

\* Optional four coding positions CR KC insert coding pin (4 pins required for each connector coupling).

### How to use CR KC coding pins (cannot be used with IP68 enclosures)

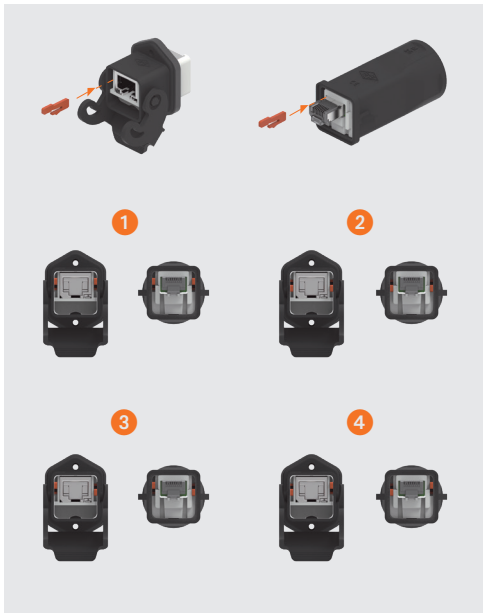

### CJK 8M

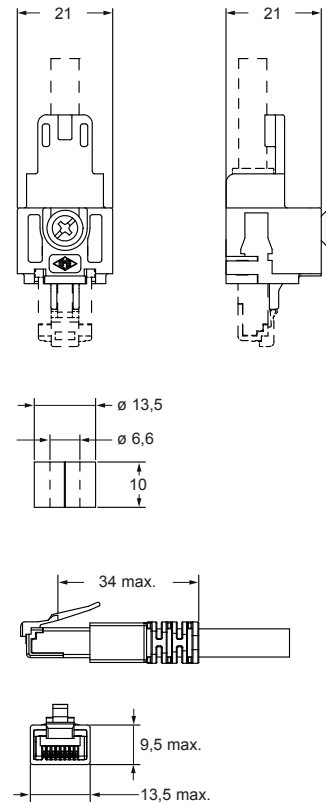

### CR KC

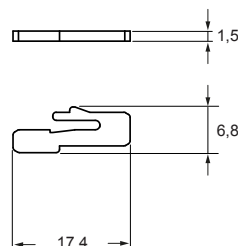

### AW M25IJ and AW M25INJ

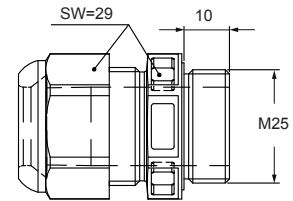

### AW M25PJ

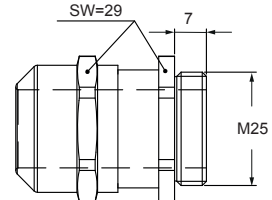

cURus pending



Watch our online tutorial

Female inserts

Housings

RJ45 CONNECTOR Cat 6<sup>A</sup>

RJ45 female/female coupler  
(8 data contacts)



CJK 8FT

RJ45 female/IDC jack  
(8 data contacts)



CJK 8IFT  
CJK 8B IFT  
CJK 8P IFT

RJ45 CONNECTOR Cat 5-5<sup>e</sup>

RJ45  
female crimp coupler jack  
(8 data contacts)



CX 8 JF + CJ KF

RJ45  
female crimp coupler jack  
(8 data + 2 power contacts)



CX 8/2 JF + CJ KF

MK VGN25\*\*\*\*  
MK VG25\*\*\*\*

CK 03 IN  
CK 03 I

21.21 CK PLASTIC

CKAX 03 I

CKAX 03 ILS

CKAX IAPS\*\*\* /APS\*\*\* /VGS\*\*\*  
MKAX IAP20\*\*\* /AP20\*\*\* /VG20\*\*\*

CKAX 03 IA4\*  
MKAX AP25 /IAP25\*\*\*\*

MKAX IF

CKAX 03 CXA  
(cover for hoods)

21.21 CKA METAL

CGKI

CGK IAP13\*\*\*  
MGK IAP20\*\*\*

21.21 CKG IP68

Legend

- \* angled enclosures cannot be used with CX 8 J6IM, CJK 8FT/IFT, CLK and CJ KF inserts/adaptor
- \*\* version with 4 data crossover wirings on request (CX4 JF, CX4/2 JF)
- \*\*\* cannot be used with CJ KF adaptor
- \*\*\*\* suitable cable glands AW M25 PJ/IJ/INJ
- \*\*\*\*\* suitable cable glands AW M25 PJ/IJ/INJ + CR CJK G gasket; cannot be used with CJ KF adaptor

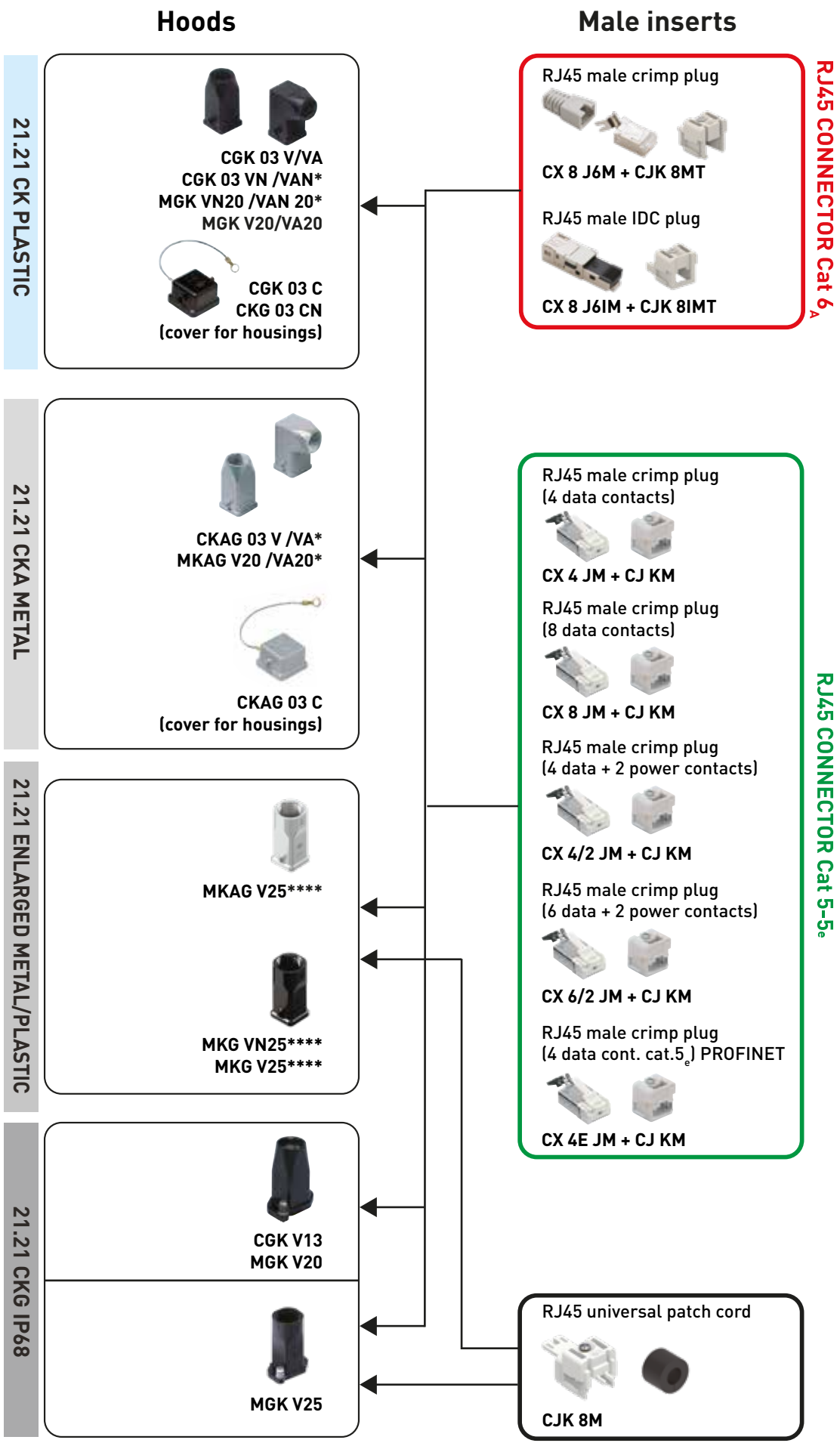

# CUK adapters with 1 USB connector

enclosures: page:  
 size "21.21"  
 insulating type 346 - 348  
 (CK IN, CKG/MKG VN/VAN \*)  
 metallic type 349 and 354  
 (CKAX I, CKAX/MKAX IAP/AP/VG) 355  
 (CKAG/MKAG V/VA \*)  
 IP68 628 - 631  
 (CKG I, CKG/MKG IAP, CKG/MKG V)  
 \* angled enclosures cannot be used with CX 8 J6IM

## USB female - female connectors

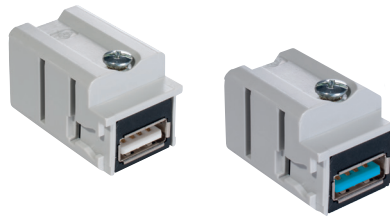

## patch cable USB



description

part No.

part No.

female insert with USB 2.0 female - female connector  
 female insert with USB 3.0 female - female connector,  
 patch cable USB-A / USB-A, 2 m \*

**CUK 2FT**  
**CUK 3FT**

**CW 2 UAM**

\* 5 m on request

### USB connector features:

- USB-A / USB-A Hi-Speed - 2.0 or 3.0 insert
- temperature range: from -25 °C to +80 °C

- (UL for USA and Canada) certified

### CUK 2FT

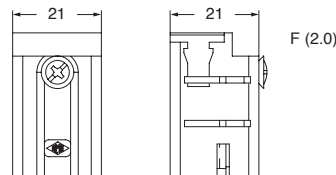

### CUK 3FT

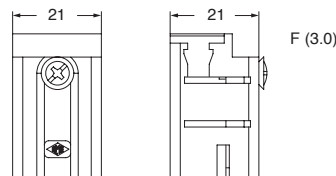

### CW UAM

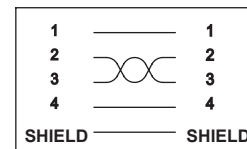
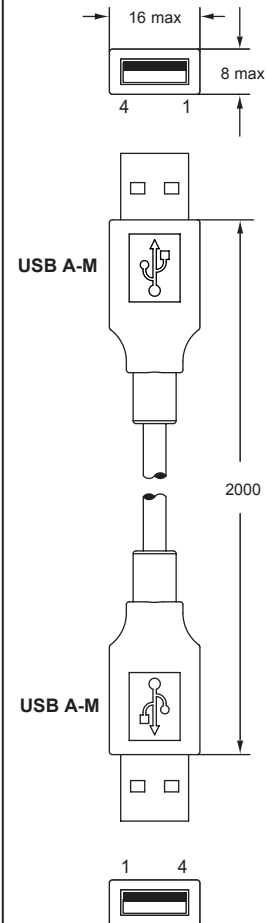

DATA CONNECTORS

# ATR cover for boxes for unit Ø 22 mm

cover for RJ45/USB/LC connectors



RJ45/USB/LC connectors for ATR C22

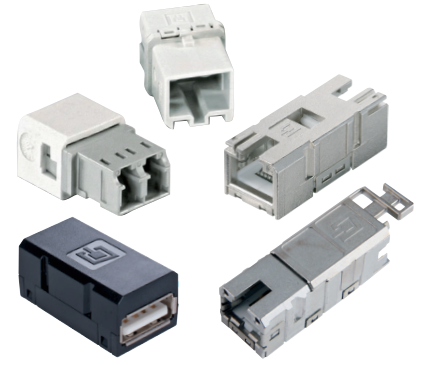

description	part No.	part No.
communication interface bulkhead IP65	<b>ATR C22</b>	
RJ45 jack A Cat.6A *		<b>AT 8IFT</b>
RJ45 coupler Cat.6		<b>AT 8FT</b>
USB 2.0 coupler F-F Type A		<b>AT U2F</b>
USB 3.0 coupler F-F Type A		<b>AT U3F</b>
LC-Duplex adapter MM		<b>AT LCMM</b>
LC-Duplex adapter SM		<b>AT LCSM</b>

\* jack B and jack P on request

### Technical Data

#### Mechanical Characteristics

<b>Materials</b>	
Housing	PA UL94V-0 - black
Nut	PA UL94V-0 - black
Bulkhead protective cap	EPDM
Elastic band / Seal	EPDM
EU Directive 2011/65/EU (RoHS)	RoHS-compliant

#### Environmental Requirements

<b>Protection against ingress</b>	
Particulate ingress	IP6X
Water / Immersion	IPX5
Degrees of protection provided by enclosures (IP code)	IEC 60529

#### Climatical and chemical

Ambient temperature	-40 °C ... + 70 °C
---------------------	--------------------

#### Mounting dimensions

wall thickness 1-5 mm (0,039-0,197 in.)

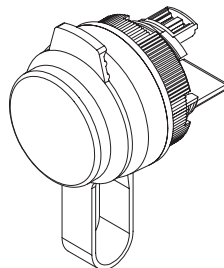
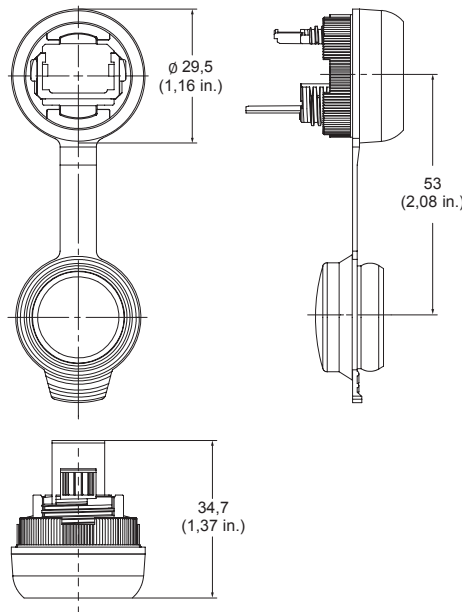
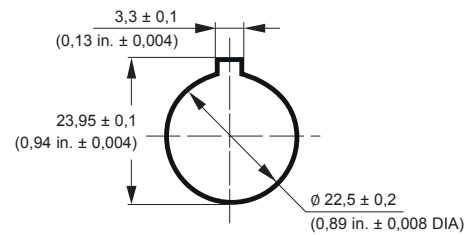

#### AT 8IFT (RJ45 IDC-FEMALE)

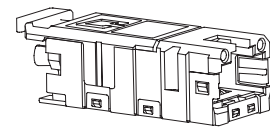

#### AT 8FT (RJ45 FEMALE-FEMALE)

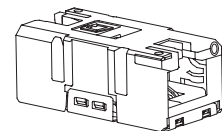

#### AT U2F (USB 2.0)

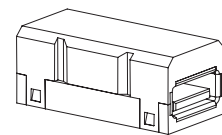

#### AT U3F (USB 3.0)

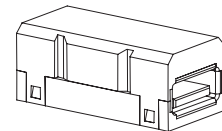

#### AT LCMM - AT LCSM (LC DUPLEX)

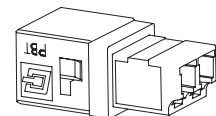

## CLK 04 SC adapters

### TECHNICAL FEATURES

The new adapter CLK 04 SC enables use of fibre optic SC contacts, up to 4 SC contacts per connector, for indoor or outdoor heavy duty industrial applications, with ILME connector enclosures size "21.21" series CKA (IP66/IP67/IP69, metallic, both C-TYPE, grey-painted, for normal environments, and W-TYPE black-painted, for aggressive environments, only the hood models provided with sealing gasket), series CGK/MGK (IP66/IP68/IP69, metallic, either Pg or metric-threaded cable outlet) and series CK (IP66/IP67/IP69, insulating, only the hood models provided with sealing gasket).

The fibre optic SC contacts (genderless, to be purchased separately) are available both for multi-mode fibres (50/125  $\mu\text{m}$  or 62,5/125  $\mu\text{m}$ ) and single-mode fibre (9/125  $\mu\text{m}$ ). The fibre optic SC contacts are also available for the hard-clad silica (HCS) or polymer-clad fibre (PCF) 200/230  $\mu\text{m}$  fibre optic cables and for the less demanding, with shorter transmission distance covered, but more cost effective POF  $\varnothing$  1 mm applications, available with crimp technique version (crimping tool required).

#### NOTE

Due to the higher skill and training required to produce an effectively performing fibre optic junction for a single-mode type fibre-optic cable than for a multi-mode one, dedicated contacts for single-mode are available only upon request. Contact our Commercial Department for a quotation. It is more practical in such case to equip the CLK 04 SC adaptor with ready-to-use fibre optic patch cords. Quick assembly technique version (tool-less) for POF  $\varnothing$  1 mm cables are also available only upon request, please send inquiry to our Commercial Department.

The female adapter inserts are provided with 4 ceramic (zirconia) type split alignment sleeves, for minimal insertion loss (e.g. critical network connections) and best suitable for single-mode F/O cable connections. As optional accessory, metallic (phosphor bronze) split alignment sleeves are also available for more durable (less prone to cracking) applications, but less demanding precision alignment, thus most suitable for multi-mode fibre applications.

Part No. of adapter	CLK 04 SC
No. of seats/poles for optical contacts	4
Ambient temperature limit ( $^{\circ}\text{C}$ )	min -40 / max +70
Degree of protection with enclosures (according to type)	IP66/IP67/IP69, IP66/IP68/IP69
Conductor connections	crimp
Mechanical endurance (rating cycles)	$\geq 500$
Self-extinguishing capacity UL 94	V0

#### CLK 04 SC Assembling instructions

##### FEMALE

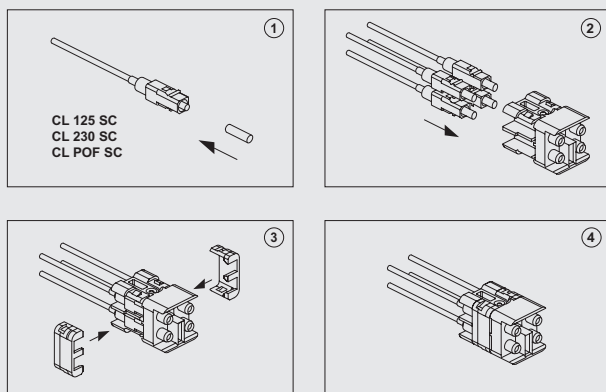

##### MALE

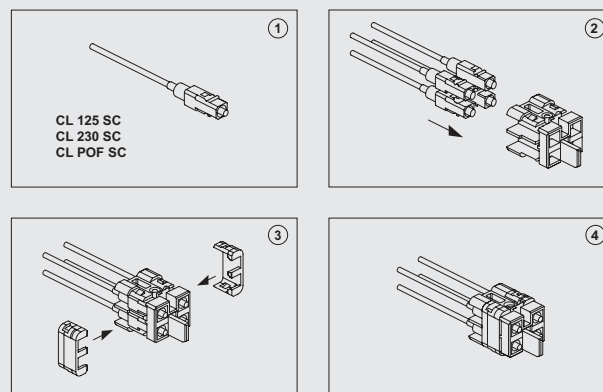



# CLK adapters 4 seats for fibre optic SC contacts

enclosures: page:  
 size "21.21"  
 insulating type 346 - 348  
 (CK IN, CKG/MKG VN)  
 metallic type 349 and 354  
 (CKAX I, CKAX/MKAX IAP/AP/VG) 355  
 (CKAG/MKAG V)  
 IP68 628 - 631  
 (CKG I, CKG/MKG IAP, CKG/MKG V)

## adapter insert for SC connectors

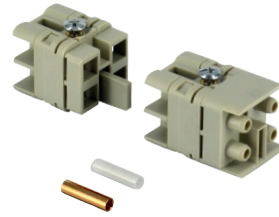

## crimp FO contacts



description	part No.	part No.
-------------	----------	----------

adapter insert with seats for 4 contacts	<b>CLK 04 SCF</b>	<b>CL 125 SC</b>
female insert, with ceramic sleeve	<b>CLK 04 SCF-H</b>	<b>CL POF SC</b>
female insert, with metallic sleeve	<b>CLK 04 SCM</b>	
male insert		
SC contact for GI FIBRE 50/125 µm or 62.5/125 µm		
SC contact for 1 mm Ø POF		

- adapter insert fitted with fixing screw and gasket, suitable for installation in enclosures
- adapter insert designed to be used with SC contacts
- SC contact for SI FIBRE (HCS®) 200/230 µm: **CL 230 SC** (on request)
- base equipment for SC contact GI FIBRE: **CLKZ 125 SC**  
If this application is required, please contact ILME S.p.A.
- supplementary set for POF: **CLKZ POF**  
(to be ordered with CLKZ 125 SC)  
If this application is required, please contact ILME S.p.A.
- (UL for USA and Canada),   
 certified
- insulation resistance: ≥ 10 GΩ

### CLK 04 SCF, CLK 04 SCM

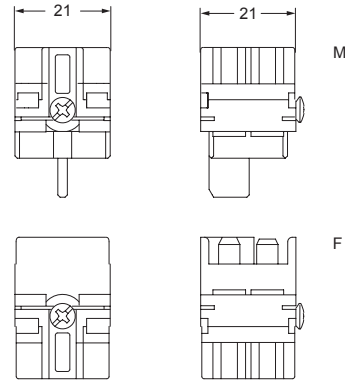

### contacts side (front view)

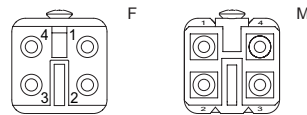

### CL 125 SC

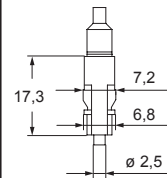

### CL POF SC

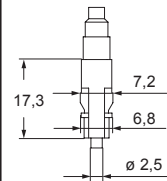

**CW SC patch cord FO SC duplex patch cords**

SC duplex patch cord

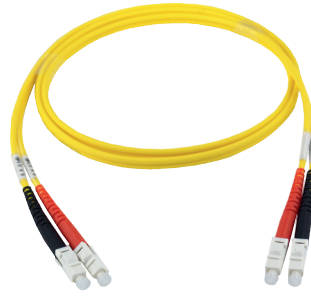

SC duplex patch cord



DATA CONNECTORS

description	part No.	(L) meter	part No.	(L) meter
SC duplex patch cord, GL fibre E9/125 (YELLOW)	<b>CW 1 SC9</b>	1		
	<b>CW 2 SC9</b>	2		
	<b>CW 3 SC9</b>	3		
	<b>CW 5 SC9</b>	5		
	<b>CW 10 SC9</b>	10		
SC duplex patch cord, GL fibre G50/125 (ORANGE)	<b>CW 1 SC50</b>	1		
	<b>CW 2 SC50</b>	2		
	<b>CW 3 SC50</b>	3		
	<b>CW 5 SC50</b>	5		
	<b>CW 10 SC50</b>	10		
SC duplex connector, GL fibre G62,5/125 (ORANGE)	<b>CW 1 SC62</b>	1		
	<b>CW 2 SC62</b>	2		
	<b>CW 3 SC62</b>	3		
	<b>CW 5 SC62</b>	5		
	<b>CW 10 SC62</b>	10		

- operating temperature: from -5 °C + +55 °C
- storage temperature: from -30 °C + +70 °C
- installation temperature: from -5 °C + +50 °C
- flame retardancy: IEC 60332-1
- halogen-free acc. to: IEC 60754-2



## CX BD adapters inserts

## TECHNICAL FEATURES

To be able to use circular shielded connectors series MIXO BUS (multiaxial, for balanced cables with multiple pairs) or coaxial connectors (for coaxial cables) even in compact enclosures size "21.21" CKA/MKA or CGK/MGK, it is necessary to purchase the new adapter insert CX 1/2 BD.

This insert can be used to assemble MIXO coaxial connectors part No. CX 01 BM/BF for coaxial cables with a characteristic impedance of 75  $\Omega$  and CX 01 BCM/BCF for coaxial cables with a characteristic impedance of 50  $\Omega$ , or MIXO BUS CX 04 BM/BF multiaxial shielded connectors with 4 poles + shield and the new CX 08 BM/BF shielded connectors with 8 poles + shield, in addition to providing seats for 2 additional optional contacts series CD for the connection of a SELV (safety extra-low voltage) supply line.

The connector portion of this adaptor has rated values compliant with standard EN 61984 and equivalent to 10A 50V 0,8kV 3.

Adaptor insert CX 1/2 BDM/BDF is fitted with multiaxial and coaxial MIXO BUS shielded connectors and is designed to be used only with the models specified below of the following enclosures: CKA/MKA (IP66/IP67/IP69) or CGK/MGK (IP66/IP68/IP69) with gasket. The cable shielding is electrically separated from the earthing connection of the metal enclosure. If used with MIXO BUS CX 04 BM/BF shielded connectors, the connector is able to support all field bus protocols with 4 conductors.

Part No. of adapter		CX 1/2 BD
No. of seats/poles	seats for shielded connector <sup>1)</sup>	1
	seats for auxiliary contacts	2
Rated current <sup>2)</sup>	shielded connector	depending on type: 5A, 10A, 16A
	auxiliary contacts	10A
EN 61984	rated voltage	50V
	rated impulse withstand voltage	0,8kV
	pollution degree	3
UL 1977 / CSA C22.2 - N°187.3	rated voltage (a.c./d.c.)	50V
Contact resistance	shielded connector	depending on the type of contact used
	auxiliary contacts	$\leq 3 \text{ m}\Omega$
Insulation resistance		$\geq 10 \text{ G}\Omega$
Ambient temperature limit (°C)	min	-40
	max	70
Degree of protection	with enclosures (according to type)	IP66/IP67/IP69, IP66/IP68/IP69
	without enclosures	IP20
Conductor connections		crimp
Conductor section	shielded connector (mm <sup>2</sup> /AWG)	depending on the type of contact used
	auxiliary contacts (mm <sup>2</sup> )	0,14÷2,5
	auxiliary contacts (AWG)	26÷14
Conductors stripping length		depending of contact
Mechanical endurance (mating cycles)		$\geq 500$
Self-extinguishing capacity UL 94		V0

<sup>1)</sup> Depending on the selected shielded connector, which must be ordered separately, the number of poles + shield could be 1 (coaxial connectors), 4 (4-way multiaxial connector for 2 pairs) or 8 (8-way multiple connector, for example for 4 pairs).

<sup>2)</sup> It is generally necessary to refer to the loading curves of the inserts to determine the actual operating current limit for a specific ambient temperature. These curves are not required for MIXO BUS / coaxial shielded connectors, because these are signal connectors designed to be used by the transmission protocols to transmit currents in fractions of amperes. The current capacity specified is the maximum current traditionally assigned to contacts, not the one assigned to the shielded connector when in use.

## CLK 04 SC Assembling instructions

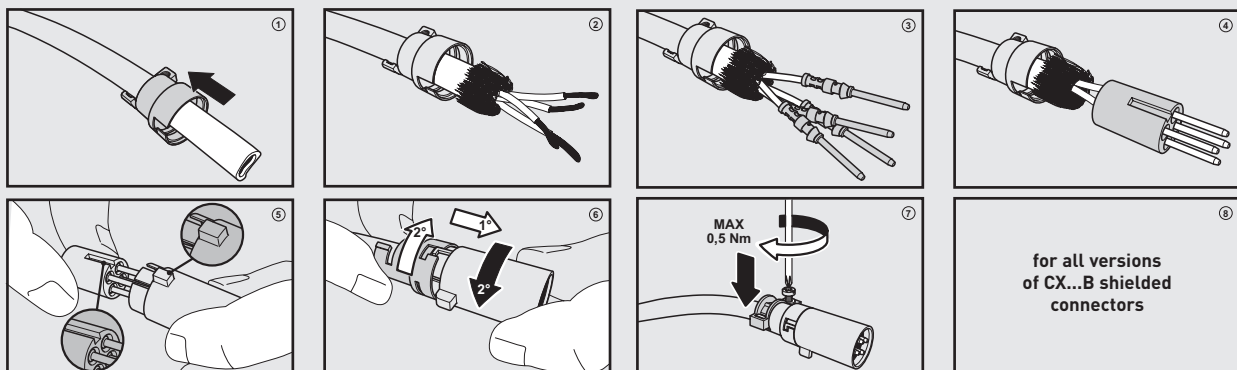

enclosures: page:  
 size "21.21"  
 metallic type  
 (CKAX I, CKAX/MKAX IAP/AP/VG) 349 and 354  
 (CKAG/MKAG V) 355  
 IP68 628 - 631  
 (CKG I, CKG/MKG IAP, CKG/MKG V)

adapter insert for shielded connectors

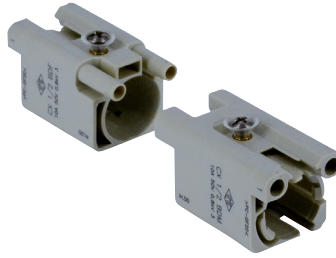

10A crimp contacts, silver or gold plated



description	part No.	part No.
-------------	----------	----------

adapter insert with seats for 1 shielded connector + 2 aux contacts 10A  
 female insert, 1 seat for BUS connector and 2 seats for 10A female contacts (CDF)  
 male insert, 1 seat for BUS connector and 2 seats for 10A male contacts (CDM)

**CX 1/2 BDF**  
**CX 1/2 BDM**

10A female contacts

0,14-0,37 mm <sup>2</sup>	AWG 26-22	identification No. 1
0,5 mm <sup>2</sup>	AWG 20	identification No. 2
0,75 mm <sup>2</sup>	AWG 18	identification No. ②
1 mm <sup>2</sup>	AWG 18	identification No. 3
1,5 mm <sup>2</sup>	AWG 16	identification No. 4
2,5 mm <sup>2</sup>	AWG 14	identification No. 5

10A male contacts

0,14-0,37 mm <sup>2</sup>	AWG 26-22	identification No. 1
0,5 mm <sup>2</sup>	AWG 20	identification No. 2
0,75 mm <sup>2</sup>	AWG 18	identification No. ②
1 mm <sup>2</sup>	AWG 18	identification No. 3
1,5 mm <sup>2</sup>	AWG 16	identification No. 4
2,5 mm <sup>2</sup>	AWG 14	identification No. 5

silver plated		gold plated <sup>+</sup>	
<b>CDFA 0.3</b>		<b>CDFD 0.3</b>	
<b>CDFA 0.5</b>		<b>CDFD 0.5</b>	
<b>CDFA 0.7</b>		<b>CDFD 0.7</b>	
<b>CDFA 1.0</b>		<b>CDFD 1.0</b>	
<b>CDFA 1.5</b>		<b>CDFD 1.5</b>	
<b>CDFA 2.5</b>		<b>CDFD 2.5</b>	
<b>CDMA 0.3</b>		<b>CDMD 0.3</b>	
<b>CDMA 0.5</b>		<b>CDMD 0.5</b>	
<b>CDMA 0.7</b>		<b>CDMD 0.7</b>	
<b>CDMA 1.0</b>		<b>CDMD 1.0</b>	
<b>CDMA 1.5</b>		<b>CDMD 1.5</b>	
<b>CDMA 2.5</b>		<b>CDMD 2.5</b>	

- characteristics according to EN 61984: adaptor insert CX 1/2 BD (2 aux contacts)  
**10A 50V 0,8kV 3**
- (UL for USA and Canada), certified
- **it is recommended to crimp the contacts with crimping tools homologated by ILME** (please see the crimping tool section 10A contacts, CDF and CDM series on pages 705 - 741)
- extraction tool for BUS/coax shielded connectors from adaptor insert CX 1/2 BD part No. CX BES see page 703
- contact resistance adaptor insert, 2 aux contacts: ≤ 3 mΩ
- adapter insert fitted with fixing screw and gasket, suitable for installation in enclosures
- adapter insert designed to be used with CX01 BCF/M CX 01 BF/M, CX 04 BF/M and CX 08 BF/M shielded connectors see pages 259, 261, 263

**CX 1/2 BDF, CX 1/2 BDM**

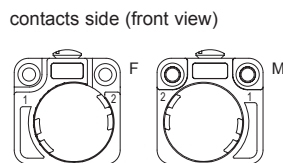
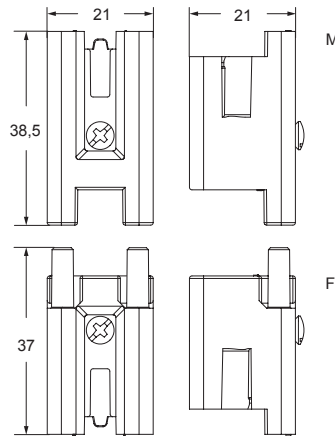

**CDF and CDM**

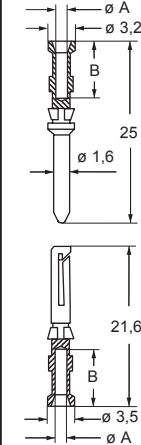

**CDF and CDM contacts**

conductor section mm <sup>2</sup>	conductor slot ø A (mm)	conductors stripping length B (mm)
0,14-0,37	0,9	8
0,5	1,1	8
0,75	1,3	8
1,0	1,45	8
1,5	1,8	8
2,5	2,2	6

<sup>+</sup> for basic or high thickness gold plating, please refer to page 674

## TECHNICAL FEATURES

**DESINA®** (which stands for **DE**centralised and **Standardised IN**stallation technology) is an innovative installation concept behind a study headed by the German manufacturers of machine tools association (VDW), with the co-operation of users (including German automotive manufacturers) and component manufacturers, which has led to the introduction of a specification aimed to standardise electrical, hydraulic and pneumatic components and their interconnection on common platform for CNC controlled machine tools and manufacturing lines.

In the last few years, the DESINA® specification has been successfully endorsed by the ISO TC 184/SC 1 "Industrial automation systems and integration / Physical device control" as an ISO standard.

This work has been completed, and the following standards have become available:

**ISO 23570-1** Industrial automation systems and integration – Distributed installation in industrial applications:  
Part 1 – Sensors and actuators.

**ISO 23570-2** Industrial automation systems and integration – Distributed installation in industrial applications:  
Part 2 – Hybrid communication bus.

**ISO 23570-3** Industrial automation systems and integration – Distributed installation in industrial applications:  
Part 3 – Power distribution bus.

Normally, production systems are controlled by various field buses available on the market such as PROFIBUS, CAN, INTERBUS, etc. DESINA® decentralised approach and interface and connector standardisation, which allows a single distributed control system to be independent from the bus communication protocol selected by the final user, ensure lower installation costs.

The availability of diagnostic capabilities in all the system components ensures a speedier diagnosis in the event of faults and an easier and quicker reset operation, which may be carried out by less specialised staff. DESINA® connection topology requires a **control bus** and a **power bus**.

The hybrid (optical/electrical) control bus provides a serial connection for the devices by using a cable consisting of two fibre optics and four power lines. The devices are fitted with 2 hybrid connectors (and matching flush mounted enclosures) for bus entry and exit.

The hybrid connectors include an interface circuit which turns the TX electrical signal to optical signal with TTL levels and the RX signal from optical to electrical signal with TTL levels.

In other words, **the interface is independent from the selected field bus protocol**, and simply converts the electrical signals into optical signals and vice versa; by doing so, the physical connection between the devices can be used for different bus protocols and can reach a 50 m range by using POF plastic fibres or 300 m by using HCS® fibreglass (Hard Clad Silica – Spectran Corporation registered trademark). The highest baud rate is 12 Mbit/s, compatible with the most advanced field buses.

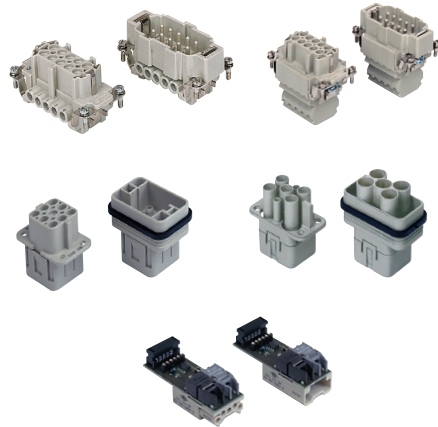

**ISO 23570-3 standard and  
DESINA® specification compliant**

Another variant is also available, which is based on transmitting data on a pair of screened copper cables (instead of fibre optics); in this case, however, the system can only be used for PROFIBUS or CAN buses with RS 485 TX signals.

In both cases, the connector is fitted with housings for 5, 10A auxiliary contacts (**CD** series crimp contacts), which allow all connected devices to receive a permanent direct voltage of 24V (to supply circuits) and a 24V non permanent power supply (only used to open the contactors after operating an emergency switch or a safety switch), as well as a contact available for an optional earth.

The power bus provides a serial connection for drives, controls and power supplies and, more specifically, is suitable to supply power to motors and to their control units.

The standard connector to control motors is the **CQM/F 08** which, with 8 poles + ⊕ 16A 500V, and **CC** series crimp contacts, not only provides a power connection, but also connects the motor brake and safety thermistor.

Another variant is available in the same sizes as the enclosure: **CQM/F 04/2** featuring 4 poles + ⊕ 40A 400/690V and 2, 10A 250V auxiliaries.

For the motor side connection, the connector **CNEM/F 10** (10P + ⊕ 16A 500V 6kV 3, with screw terminals) should be used; with the option to make a star or a delta connection on the connector, the **CSSM/F 10** connector (10P + ⊕ 16A 500V 6kV 3, with spring terminals, two per pole) should be used.

ILME connectors are manufactured to DESINA® specifications and in compliance with ISO 23570-2 and 23570-3 standards.



## Hybrid socket and plug connectors for field buses compliant with DESINA® specifications and with ISO 23570-2 standard

The hybrid connectors for field buses are listed below:

- optical field bus **plug**

- optical field bus **socket**

**electrical auxiliary female contacts**

**CXL 2/4 PF** (for plastic fibre optics POF)

**CXL 2/4 PFH** (for glass fibre optics HCS®)

**CXL 2/4 SF**

**electrical auxiliary male contacts**

**CXL 2/4 PM** (for plastic fibre optics POF)

**CXL 2/4 PMH** (for glass fibre optics HCS®)

**CXL 2/4 SM**

The hybrid inserts for **socket** type optical field buses can only be fitted inside **fixed enclosures**.

The **plug** types, on the other hand, can only be fitted inside **free enclosures (hoods)**.

The enclosures and matching accessories available are listed below:

Construction details

- fixed, flush mounted enclosure:

- free enclosures (hoods), top entry:

- free enclosures (hoods), side entry:

- cover:

Material: **PLASTIC**

**CK 03 IN**

**CKG 03 VN** (Pg 11)

**MKG VN20** (M 20)

**CKG 03 VAN** (Pg 11)

**MKG VAN20** (M 20)

**CKG 03 CN**

Material: **METAL**

**CKAX 03 I**

**CKAG 03 V** (Pg 11)

**MKAG V20** (M 20)

**CKAG 03 VA** (Pg 11)

**MKAG VA20** (M 20)

**CKAG 03 C**

The portable enclosures and the covers are fitted with an additional seal in order to achieve the versatile **IP65/IP67** degree of protection according to IEC/EN 60529. With these accessories the enclosures also achieve the **IP69** degree of protection (tightness to high pressure and temperature water jets) according to the same standard. The full versatile degree of protection becomes therefore **IP65/IP67/IP69**. The **IPX9** test is identical with that of former German standard DIN 40050-9 (IP69K) currently specified by **ISO 20653** for use on board road vehicles.

## Specifications

### Interface

Hybrid electrical-optical connector insert consisting of 2 connectors for fibre optics and 4 contacts for electrical wires; an interface circuit built into the optical socket converts the electrical signals into optical signals and vice versa.

### Optical parts

transmitter (T): Agilent (HP) Versatile Link HFBR-1525, or equivalent

receiver (R): Agilent (HP) Versatile Link HFBR-2525, or equivalent

male optical contact: Agilent (HP) Versatile Link

HFBR-4531, or equivalent, Simplex snap-in type (without crimping) for POF plastic fibre optics;

HFBR-4521, or equivalent, crimp contact, for HCS® glass fibre optics

note: POF is a plastic fibre optic with a 1000 µm diameter for red light and wavelength = 660 nm.

HCS® is a Hard Clad Silica glass fibre optic with a 200 µm diameter for red light with wavelength = 660 nm.

Optical parts:

laser class I

### Electrical contacts

4 maximum current 10A, gold or silver plated brass crimp contacts, cable section 0,14...2,5 mm<sup>2</sup> (CD series); live wire end female. Nominal voltage 24V.

Electrical data in compliance with EN 61984: **10A 25V 0.8kV 3**

Degrees of protection: IP65/IP67/IP69 according to EN 60529 (if a cable clamp with IP67/IP69 rating is used).

Temperature range: -40 °C / +70 °C

Data transmission/reception rate (Data rate): up to 12 Mbit/s

## Designation of auxiliary electrical contacts

Designation of auxiliary electrical contacts (male and female) in the hybrid socket connector with optical TX system:

### Socket connector with male auxiliary electrical contacts CXL 2/4 SM

Pos.	Function
1:	+ 24V not switched
2:	0V (reference for contact 1)
3:	0V (reference for contact 4)
4:	+ 24V switched

optical →

electrical →

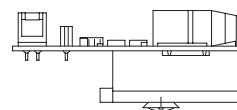
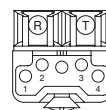

### Socket connector with female auxiliary electrical contacts CXL 2/4 SF

Pos.	Function
1:	+ 24V not switched
2:	0V (reference for contact 1)
3:	0V (reference for contact 4)
4:	+ 24V switched

optical →

electrical →

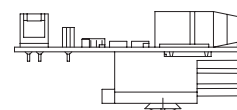
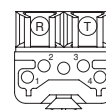

### Insulation displacement connector (IDC) for ribbon flat cable on printed circuit

Pos.	Function	Pos.	Function
1:	earth	6:	TXD
2:	RXD	7:	earth
3:	RXD	8:	+5V DC
4:	earth	9:	+5V DC
5:	TXD	10:	earth

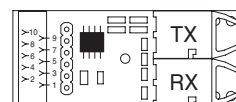

The contacts in the hybrid socket connector are numbered in a clockwise direction.

With reference to this, the contacts in the field bus hybrid plug connector are numbered anticlockwise.

"R" Data reception (beam exit) - "T" Data transmission (beam entry).

**Socket and plug connectors for power buses compliant with DESINA® specifications and with ISO 23570-3 standard**

The connector inserts on the power bus for a motor controller are as follows:

- **CQM 08** plug
- **CQF 08** socket

The connector inserts for the motor controller may be fitted inside the following enclosures:

Construction details  
Material: **PLASTIC**

- bulkhead mounting, straight, fixed enclosure: **CQ 08 I**
- bulkhead mounting, angled, fixed enclosure: **CQ 08 IA**
- bulkhead mounting, angled, fixed enclosure, rear entry: **CQ 08 IAP**
- free enclosure (hood), top entry: **CQ 08 V**
- free enclosure (hood), side entry: **CQ 08 VA**
- free enclosure (hood), top entry and lever: **CQ 08 VG**
- free enclosure (hood), side and top entry: **MQ 08 VO225**
- socket cover: **CQ 08 C**
- plug cover: **CQ 08 CA**

The **CQ/MQ 08** enclosures and covers once complete and fitted with suitably rated cable gland or conduit fitting ensure the versatile **IP65/IP67** degree of protection according to IEC/EN 60529. With these accessories the enclosures also achieve the **IP69** degree of protection (tightness to high pressure and temperature water jets) according to the same standard. The full versatile degree of protection becomes therefore **IP65/IP67/IP69**. The **IPX9** test is identical with that of former German standard DIN 40050-9 currently specified by **ISO 20653** for use on board road vehicles.

**Specifications**

- Connection:** **9 contacts (8 + ⊕)**  
The male connectors (plugs) are used for termination of connecting cables; the female connectors (sockets) are fitted on the motor controller
- Electrical contacts:** 9 maximum current 10A, gold or silver plated crimp contacts, cable section 0,5...2,5 mm<sup>2</sup> (20 AWG -14 AWG) CC series
- Degrees of protection:** IP65/IP67/IP69 according to EN 60529 (if a cable clamp with IP67/IP69 rating is used)
- Temperature range:** 40 °C / +125 °C
- Electrical data:** compliant with EN 61984: **16A 500V 6kV 3**
- Self extinguishing properties:** 94V-0 compliant with UL 94 standard; glow-wire 960 °C compliant with IEC/EN 60695-2-11 standard

**Designation of contacts**

The designation of contacts for motor controller outlet is as follows:

contact	designation
1	line L1
2	
3	line L3
4	brake (0 V)
5	temperature sensor
6	brake (+24V c.c.)
7	line L2
8	temperature sensor
PE	protective earth

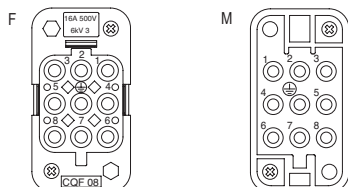

The connector inserts on the power bus for a motor controller are as follows:

- **CQM 04/2** plug
- **CQF 04/2** socket

These connector inserts can be fitted inside the following enclosures:

Construction details  
Material: **PLASTIC**

- bulkhead mounting, straight, fixed enclosure: **CQ 08 I**
- bulkhead mounting, angled, fixed enclosure: **CQ 08 IA**
- bulkhead mounting, angled, fixed enclosure, rear entry: **CQ 08 IAP**
- free enclosure (hood), top entry: **CQ 08 V**
- free enclosure (hood), side entry: **CQ 08 VA**
- free enclosure (hood), top entry and lever: **CQ 08 VG**
- free enclosure (hood), side and top entry: **MQ 08 VO225**
- socket cover: **CQ 08 C**
- plug cover: **CQ 08 CA**

The **CQ/MQ 08** enclosures and covers once complete and fitted with suitably rated cable gland or conduit fitting ensure the versatile **IP65/IP67** degree of protection according to IEC/EN 60529. With these accessories the enclosures also achieve the **IP69** degree of protection (tightness to high pressure and temperature water jets) according to the same standard. The full versatile degree of protection becomes therefore **IP65/IP67/IP69**. The **IPX9** test is identical with that of former German standard DIN 40050-9 (IP69K) currently specified by **ISO 20653** for use on board road vehicles.

**Specifications**

- Connection:** **5 (4 + ⊕) power contacts + 2 auxiliary contacts**  
The male connectors (plugs) are used for termination of connecting cables; the female connectors (sockets) are fitted on the motor controller
- Electrical contacts:** 5 maximum current 40A (3P+N+⊕) gold or silver plated crimp contacts, cable section 1,5...6 mm<sup>2</sup> (16 AWG -10 AWG) CX series; 2 maximum current 10A, gold or silver plated crimp contacts, cable section 0,14...2,5 mm<sup>2</sup> (26 AWG -14 AWG) CD series
- Degrees of protection:** IP65/IP67/IP69 according to EN 60529 (if a cable clamp with IP67/IP69 rating is used)
- Temperature range:** -40 °C / +125 °C
- Electrical data:** compliant with EN 61984: **40A 400/690V 6kV 3**
- Self extinguishing properties:** 94V-0 compliant with UL 94 standard glow-wire 960 °C compliant with IEC/EN 60695-2-11 standard

**Designation of contacts**

The designation of contacts for motor controller outlet is as follows:

contact	designation
1	line L1
2	line L2
3	line L3
4	neutral
PE	protective earth
11	aux
12	aux

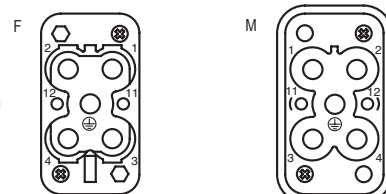

DESINA®

The connector inserts on the power bus for a motor controller are as follows:

	screw type	spring type
	with cover	dual terminal for pole
- plug	<b>CNEM 10 T</b>	<b>CSSM 10</b>
- socket	<b>CNEF 10 T</b>	<b>CSSF 10</b>

To be installed in the enclosures illustrated in this catalogue or equivalent, with single lever (directed towards the motor).

The enclosures once complete and fitted with suitably rated cable gland or conduit fitting ensure the versatile **IP65/IP67** degree of protection according to IEC/EN 60529. With these accessories the enclosures also achieve the **IP69** degree of protection (tightness to high pressure and temperature water jets) according to the same standard. The full versatile degree of protection becomes therefore **IP65/IP67/IP69**. The **IPX9** test is identical with that of former German standard DIN 40050-9 (IP69K) currently specified by **ISO 20653** for use on board road vehicles.

## Specifications

<b>Connection:</b>	<b>10 contacts + ⊕</b>
<b>Electrical contacts:</b>	10 screw type contacts (CNE series) or spring type (CSS series), maximum current 16A, silver plated, wire section 0,5...2,5 mm <sup>2</sup> (20 AWG -14 AWG)
<b>Degrees of protection:</b>	IP65/IP67/IP69 according to EN 60529 (if a cable clamp with IP67/IP69 rating is used).
<b>Temperature range:</b>	-40 °C / +125 °C
<b>Electrical data</b>	compliant with EN 61984: <b>16A 500V 6kV 3</b>
<b>Self extinguishing properties</b>	94V-0 compliant with UL 94 standard glow-wire 960 °C compliant with IEC/EN 60695-2-11 standard

## Designation of contacts

The designation of contacts for motor connector is as follows:

contact	designation
1	winding U1 - L1
2	winding V1 - L2
3	winding W1 - L3
4	brake (0 V)
5	brake (+24V cc)
6	winding W2
7	winding U2
8	winding V2
9	temperature sensor
10	temperature sensor
PE	protective earth
7	line L2
8	temperature sensor
PE	protective earth

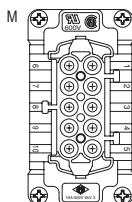
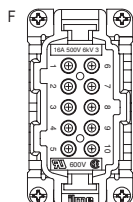

Inserts series	No. of poles		EN 61984 (2001-11) pollution degree 3			EN 61984 (2001-11) pollution degree 2			Certification UL/CSA
	main contacts	aux. contacts	rated voltage	rated impulse withstand voltage	pollution degree	rated voltage	rated impulse withstand voltage	pollution degree	
Code									rated voltage AC or DC
<b>CXL 2/4</b>	2	—	contacts for plastic fibre optics (POF) Ø 1mm						—
		4 (+⊕)	25V	0,8kV	3	—	—	—	50V
<b>CXL 2/4...H</b>	2	—	contacts for HCS® fibre optics Ø 200 µm						—
		4 (+⊕)	25V	0,8kV	3	—	—	—	50V
<b>CQ 08</b>	8 (+⊕)	—	500V	6kV	3	400/690V	6kV	2	600V
<b>CQ 04/2</b>	4 (+⊕)	—	400/690V	6kV	3	—	—	—	600V
		2	250V	4kV	3	—	—	—	600V
<b>CQ 12</b>	10 (+⊕)	—	500V	6kV	3	400/690V	6kV	2	600V
<b>CNE</b>	12 (+⊕)	—	400V	6kV	3	400/690V	6kV	2	600V

**Nominal Data**

Nominal data complies with requirements of EN 61984 standard.

**Marking example to be applied only in a mains power supply with insulated neutral or with neutral to earth in a corner (see Table 5, EN 61984):**

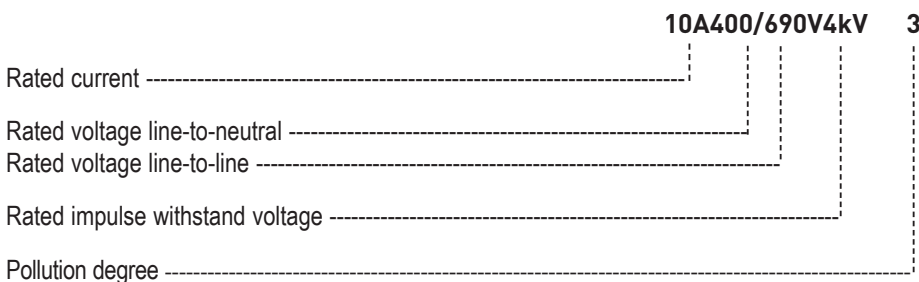

**Marking example to be applied in any mains power supplies, including those with insulated neutral and the delta power supplies with earth in a corner (see Table 5, EN 61984):**

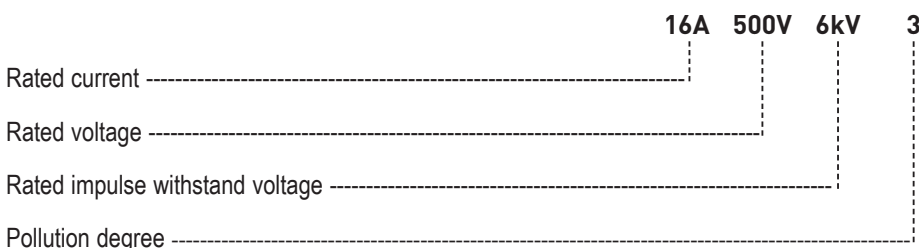

Insert series	max. rated current <sup>1)</sup>	contact resistance $\leq$	insulation resistance $\geq$	Ambient temperature limit (° C)		Protection rating		Wire connection <sup>2)</sup>					Certifications
				min	max	with enclosures	without enclosures	screw	spring	connection block at 45°	crimp	snap-in	
CXL 2/4	—	—	—	-40	+70	IP65/IP67	IP20	—					—
	10A	3 mΩ	10 GΩ	-40	+70	IP65/IP67	IP20	—	—	•	—	cUL <sub>A</sub> ), UL, EAC, DNV-GL, BV	
CXL 2/4...H	—	—	—	-40	+70	IP65/IP67	IP20	—	—	•	—	—	
	10A	3 mΩ	10 GΩ	-40	+70	IP65/IP67	IP20	—	—	•	—	cUL <sub>A</sub> ), UL, EAC, DNV-GL, BV	
CQ 08	16A	1 mΩ	10 GΩ	-40	+125	IP65/IP67	IP20	—	—	•	—	cUL <sub>A</sub> ), CSA, CQC, EAC, DNV-GL, BV	
CQ 04/2	40A	0,3 mΩ	10 GΩ	-40	+125	IP65/IP67	IP20	—	—	•	—	cUL <sub>A</sub> ), CSA, EAC, DNV-GL, BV	
	10A	3 mΩ	10 GΩ										
CQ 12	10A	3 mΩ	10 GΩ	-40	+125	IP65/IP67	IP20	—	—	•	—	cUL <sub>A</sub> ), CSA, CQC, EAC, DNV-GL, BV	
CNE	16A	1 mΩ	10 GΩ	-40	+125	IP65	IP20	•	—	—	—	cUL <sub>A</sub> ), CSA, CQC, EAC, DNV-GL, BV	







1) See the insert load curves to establish the actual maximum operating current according to the ambient temperature

2) For the wire electrical connection data, see from page 22

A) UL for USA and Canada









## Contacts series

### 10A max contacts - CD series

Conductor section		Number Identification
(mm <sup>2</sup> )	AWG	
0,14 - 0,37	26 - 22	
0,5	20	
0,75	18	
1	18	
1,5	16	
2,5	14	

 Contacts supplied in both silver/gold plated versions

### 16A max contacts - CC series

Conductor section		Throat Identification
(mm <sup>2</sup> )	AWG	
0,14 - 0,37	26 - 22	
0,5	20	
0,75	18	
1	18	
1,5	16	
2,5	14	
3,0	12	
4	12	

 Contacts supplied in both silver/gold plated versions; male contacts can also be supplied in the "advanced" version and iron/constantan contacts for thermocouples J type.

### 40A max contacts - CX series

Conductor section		Number hole
(mm <sup>2</sup> )	AWG	
1,5	16	Ø 1,75 mm
2,5	14	Ø 2,25 mm
4	12	Ø 2,85 mm
6	10	Ø 3,5 mm

 Contacts supplied in both silver/gold plated versions

**CXL 2 p fibre optics + 4 p 10A max - 25V/0,8kV/3 + ⊕ opt. DESINA®**

enclosures: page:  
 size "21.21"  
 insulating type 346 - 348  
 metallic type 354 - 355

inserts, crimp connections

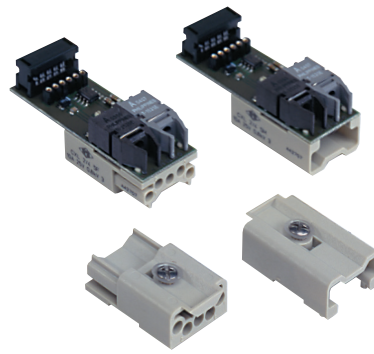

10A crimp contacts silver and gold plated



description	part No.	part No.
-------------	----------	----------

inserts for fixed enclosures, complete with electro-optical interface \*  
 without contacts (to be ordered separately)

socket inserts for female contacts **CXL 2/4 SF**  
 plug inserts for male contacts **CXL 2/4 SM**

without electro-optical interface for housings  
 without contacts (to be ordered separately)

socket inserts for female contacts **CXL SF**  
 plug inserts for male contacts **CXL SM**

10A female contacts

0,14-0,37 mm <sup>2</sup>	AWG 26-22	identification No. 1
0,5 mm <sup>2</sup>	AWG 20	identification No. 2
0,75 mm <sup>2</sup>	AWG 18	identification No. ②
1 mm <sup>2</sup>	AWG 18	identification No. 3
1,5 mm <sup>2</sup>	AWG 16	identification No. 4
2,5 mm <sup>2</sup>	AWG 14	identification No. 5

10A male contacts

0,14-0,37 mm <sup>2</sup>	AWG 26-22	identification No. 1
0,5 mm <sup>2</sup>	AWG 20	identification No. 2
0,75 mm <sup>2</sup>	AWG 18	identification No. ②
1 mm <sup>2</sup>	AWG 18	identification No. 3
1,5 mm <sup>2</sup>	AWG 16	identification No. 4
2,5 mm <sup>2</sup>	AWG 14	identification No. 5

<b>CDFA 0.3</b>	silver plated	<b>CDFD 0.3</b>	gold plated <sup>+</sup>
<b>CDFA 0.5</b>		<b>CDFD 0.5</b>	
<b>CDFA 0.7</b>		<b>CDFD 0.7</b>	
<b>CDFA 1.0</b>		<b>CDFD 1.0</b>	
<b>CDFA 1.5</b>		<b>CDFD 1.5</b>	
<b>CDFA 2.5</b>		<b>CDFD 2.5</b>	
<b>CDMA 0.3</b>	silver plated	<b>CDMD 0.3</b>	gold plated <sup>+</sup>
<b>CDMA 0.5</b>		<b>CDMD 0.5</b>	
<b>CDMA 0.7</b>		<b>CDMD 0.7</b>	
<b>CDMA 1.0</b>		<b>CDMD 1.0</b>	
<b>CDMA 1.5</b>		<b>CDMD 1.5</b>	
<b>CDMA 2.5</b>		<b>CDMD 2.5</b>	

\* fitted with IDC connector for TTL to bus connection ribbon cable

- characteristics according to EN 61984:

**10A 25V 0,8kV 3**

- certified

- rated voltage according to UL/CSA: 600V

- insulation resistance: ≥ 10 GΩ

- data baud rate: up to 12 MBit/s

- temperature range: from -40 °C to +70 °C

- contact resistance: ≤ 3 mΩ

- **it is recommended to crimp the contacts with crimping tools homologated by ILME** (please see the crimping tool section 10A contacts, CDF and CDM series on pages 705 - 741)

**CXL 2/4 SM**

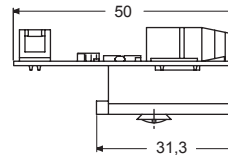
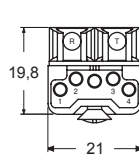

**CXL 2/4 SF**

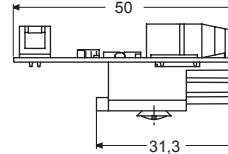
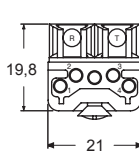

**CDF and CDM**

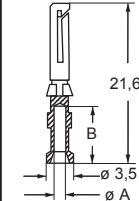
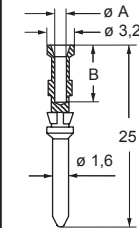

**CDF and CDM contacts**

conductor section mm <sup>2</sup>	conductor slot ø A (mm)	conductors stripping length B (mm)
0,14-0,37	0,9	8
0,5	1,1	8
0,75	1,3	8
1,0	1,45	8
1,5	1,8	8
2,5	2,2	6

<sup>+</sup> for basic or high thickness gold plating, please refer to page 674

DESINA®



# CXL 2 p fibre optics + 4 p 10A max - 25V/0,8kV/3 + ⊕ opt. DESINA®

enclosures: page:  
 size "21.21"  
 insulating type 346 - 348  
 metallic type 354 - 355

inserts, snap-in (POF)  
 or crimp (HCS®) optical connection  
 electrical crimp connection

10A crimp contacts  
 silver and gold plated

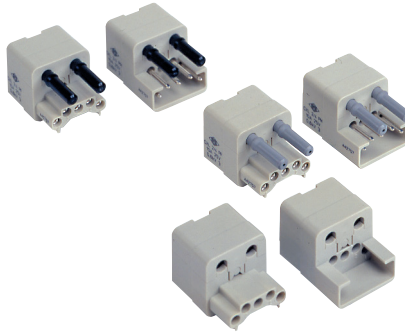

description	part No.	part No.
-------------	----------	----------

inserts for portable enclosures with:  
 4 + 1 crimp 1,5 mm<sup>2</sup> contacts (included)  
 + 2 snap on contacts for 1 mm<sup>1)</sup> plastic (POF) fibre optics  
 socket inserts with CDFA 1.5 female contacts  
 plug inserts with CDMA 1.5 male contacts

**CXL 2/4 PF**  
**CXL 2/4 PM**

inserts for hoods with:  
 4 + 1 crimp 1,5 mm<sup>2</sup> contacts (included)  
 + 2 crimp contacts for 0,2 mm<sup>2)</sup> HCS® fibre optics  
 socket inserts with CDFA 1.5 female contacts  
 plug inserts with CDMA 1.5 male contacts

**CXL 2/4 PFH**  
**CXL 2/4 PMH**

inserts for hoods with:  
 4 + 1 crimp contacts (not included – CDF and CDM series)  
 + 2 snap on or HCS® fibre optic contacts (not included)<sup>3)</sup>  
 socket inserts with female contacts  
 plug inserts with male contacts

**CXL PF**  
**CXL PM**

**10A female contacts**

0,14-0,37 mm <sup>2</sup>	AWG 26-22	identification No. 1
0,5 mm <sup>2</sup>	AWG 20	identification No. 2
0,75 mm <sup>2</sup>	AWG 18	identification No. ②
1 mm <sup>2</sup>	AWG 18	identification No. 3
1,5 mm <sup>2</sup>	AWG 16	identification No. 4
2,5 mm <sup>2</sup>	AWG 14	identification No. 5

**CDFA 0.3**  
**CDFA 0.5**  
**CDFA 0.7**  
**CDFA 1.0**  
**CDFA 1.5**  
**CDFA 2.5**

silver plated

**CDFD 0.3**  
**CDFD 0.5**  
**CDFD 0.7**  
**CDFD 1.0**  
**CDFD 1.5**  
**CDFD 2.5**

gold plated<sup>+</sup>

**10A male contacts**

0,14-0,37 mm <sup>2</sup>	AWG 26-22	identification No. 1
0,5 mm <sup>2</sup>	AWG 20	identification No. 2
0,75 mm <sup>2</sup>	AWG 18	identification No. ②
1 mm <sup>2</sup>	AWG 18	identification No. 3
1,5 mm <sup>2</sup>	AWG 16	identification No. 4
2,5 mm <sup>2</sup>	AWG 14	identification No. 5

**CDMA 0.3**  
**CDMA 0.5**  
**CDMA 0.7**  
**CDMA 1.0**  
**CDMA 1.5**  
**CDMA 2.5**

**CDMD 0.3**  
**CDMD 0.5**  
**CDMD 0.7**  
**CDMD 1.0**  
**CDMD 1.5**  
**CDMD 2.5**

<sup>1)</sup> for POF fibre preparation, the polishing kit Agitent HFBR-4593 (CXL POL) is available on request

<sup>2)</sup> for HCS® (Hard Clad Silica - SpecTran Corporation registered™) connection preparation, the Crimp & Clear cabling kit (without glue or polishing kit) for simplex connectors for 200/300 μm HCS® fibre optics is available on request.

- The (CXL KCC) kit consists of:
- No. 1 scissors for kevlar cutting
  - No. 1 cable stripper
  - No. 1 fibre stripper
  - No. 1 calibrated pliers
  - No. 1 precision fibre optics cutter with diamond blade.
  - All accessories are stored in a hard carrying case

<sup>3)</sup> see data on page 327

- characteristics according to EN 61984:

**10A 25V 0,8kV 3**

- certified
- rated voltage according to UL/CSA: 600V
- insulation resistance: ≥ 10 GΩ
- temperature range: from -40 °C to +70 °C
- contact resistance: ≤ 3 mΩ
- **it is recommended to crimp the contacts with crimping tools homologated by ILME** (please see the crimping tool section 10A contacts, CDF and CDM series on pages 705 - 741)

**CXL 2/4 PM and PMH**

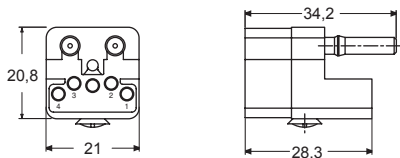

**CXL 2/4 PF and PFH**

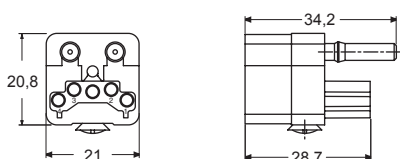

- 8 mm wire stripping
- POF 7 mm fibre stripping

**CDF and CDM**

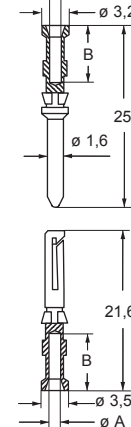

<sup>+</sup> for basic or high thickness gold plating, please refer to page 674

**CDF and CDM contacts**

conductor section mm <sup>2</sup>	conductor slot ø A (mm)	conductors stripping length B (mm)
0,14-0,37	0,9	8
0,5	1,1	8
0,75	1,3	8
1,0	1,45	8
1,5	1,8	8
2,5	2,2	6

# ENCLOSURES



## CK - MK

• Size 21.21 .....339 - 343

## CKX

• Size 21.21 .....344 - 345

## CK - CKG - MKG *DESINA*.

• Size 21.21 .....346 - 348

## CKA - MKA

• Size 21.21 .....349 - 352

## MKAG

• Size 21.21 ..... 353

## CKA - MKA *DESINA*.

• Size 21.21 .....354 - 355

## CKAX

• Size 21.21 ..... 356

## CKA - CKAXX

• Size 21.21 ..... 357

## MKAX

• Size 21.21 ..... 358, 360, 362

## MKA - MKAXX

• Size 21.21 ..... 359, 361, 363



## CQ - MQ

• Size 32.13 .....365 - 367



## MIXO ONE CXA - MXA

• Pages.....368 - 371



## IL-BRID CZ - MZ

• Size 49.16 .....374 - 377, 382

• Size 66.16 .....378 -382



## RIGID LEVER CZ7 - MZ7

• Size 49.16 ..... 384

• Size 66.16 ..... 385



### C-TYPE

- Size 44.27 .....387 - 392
- Size 57.27 .....393 - 401
- Size 77.27 .....402 - 411
- Size 104.27 .....412 - 423
- Size 77.62 .....424 - 429
- Size 104.62 .....430
- Size 66.40 .....431 - 434

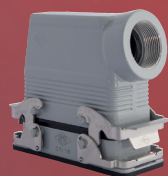

### V-TYPE IP67 V-TYPE IP65/IP66

- Size 44.27 .....436 - 437 (IP67), 444 - 447 (IP65/IP66)
- Size 57.27 .....438 (IP67), 448 - 453 (IP65/IP66)
- Size 77.27 .....439 - 440 (IP67), 454 - 458 (IP65/IP66)
- Size 104.27 .....441 - 442 (IP67), 459 - 463 (IP65/IP66)



### BIG

- Size 44.27 .....466 - 467
- Size 57.27 .....468 - 469
- Size 77.27 .....470 - 471
- Size 104.27 .....472 - 473



### T-TYPE T-TYPE / W

- Size 44.27 .....480 - 481, 489 (W)
- Size 57.27 .....482 - 483, 490 (W)
- Size 77.27 .....484 - 485, 491 (W)
- Size 104.27 .....486 - 487, 492 (W)



### HYGIENIC T-TYPE / H

- Size 44.27 .....501
- Size 57.27 .....502
- Size 77.27 .....503
- Size 104.27 .....504

### HYGIENIC T-TYPE / C

- Size 44.27 .....506
- Size 57.27 .....507
- Size 77.27 .....508
- Size 104.27 .....509

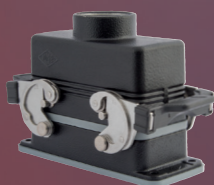

### W-TYPE

- Size 21.21 .....512 - 518
- Size 49.16 .....519
- Size 66.16 .....520
- Size 44.27 .....521
- Size 57.27 .....522
- Size 77.27 .....523
- Size 104.27 .....524
- Size 77.62 .....525
- Size 104.62 .....526
- Size 66.40 .....527



### E-Xtreme® IP67 V-TYPE lever / standard

• Size 44.27 .....	530 - 531
• Size 57.27 .....	532 - 533
• Size 77.27 .....	534 - 535
• Size 104.27 .....	536 - 537

### E-Xtreme® for aggressive environments

• Size 21.21 .....	538 - 539
• Size 49.16 .....	540
• Size 66.16 .....	541
• Size 44.27 .....	542
• Size 57.27 .....	543
• Size 77.27 .....	544
• Size 104.27 .....	545
• Size 77.62 .....	546
• Size 104.62 .....	547
• Size 66.40 .....	548

### E-Xtreme® IP68

• Size 44.27 .....	550 - 551
• Size 57.27 .....	552 - 553
• Size 77.27 .....	554 - 555
• Size 104.27 .....	556 - 557



### EMC

• Size 21.21 .....	564 - 572
• Size 32.13 .....	573 - 575
• Size 49.16 .....	576
• Size 66.16 .....	577
• Size 44.27 .....	578
• Size 57.27 .....	579
• Size 77.27 .....	580
• Size 104.27 .....	581

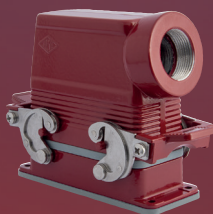

### 180 °C

• Size 21.21 .....	583 - 585
• Size 44.27 .....	586
• Size 57.27 .....	587
• Size 77.27 .....	588
• Size 104.27 .....	589
• Size 104.62 .....	590



### HNM

• Size 44.27 .....	592 - 593
• Size 57.27 .....	594 - 595
• Size 77.27 .....	596 - 597
• Size 104.27 .....	598 - 599
• Dummy hoods, self-centring floating frame.....	600 - 601





### CENTRAL LEVER

- Size 44.27 .....603 - 605
- Size 57.27 .....606 - 608
- Size 77.27 .....609 - 611
- Size 104.27 .....612 - 614
- Locking device.....615 - 616



### LS-TYPE

- Size 44.27 .....618 - 619
- Size 57.27 .....620 - 621
- Size 77.27 .....622 - 623
- Size 104.27 .....624 - 625



### IP68

- Size 21.21 .....628 - 631
- Size 44.27 .....632 - 635
- Size 57.27 .....636 - 639
- Size 77.27 .....640 - 643
- Size 104.27 .....644 - 647

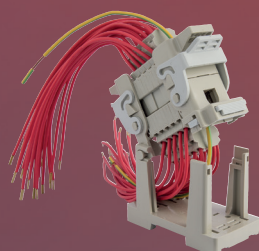

### COB for inserts

- Size 44.27 .....652 - 653
- Size 57.27 .....652 - 653
- Size 77.27 .....652 - 653
- Size 104.27 .....652 - 653
- Size 49.16 .....654
- Size 66.16 .....654

## SPECIAL ENCLOSURES

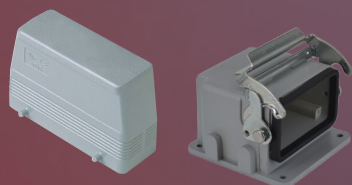

### CH BULKHEAD

- Size 44.27 .....656
- Size 57.27 .....656
- Size 77.27 .....656
- Size 104.27 .....656



### CA BOTTOM ENTRY

- Size 104.27 .....657

### CYR CABLE PASSING HOODS

.....658

### CYG ENCLOSURES FOR IN-LINE JOINTS

.....659

## Thermoplastic and metallic enclosures size “21.21” for standard or aggressive environments and insulated version size “32.13”

### SUM-UP

- ☒ For use with all size “21.21” connector inserts;
- ☒ Connector inserts for use at SELV are prevented to be installed in metallic enclosures CKA-MKA, CGK-MGK (as they would not provide protective earth connection for the enclosure) thanks to a special key and keyway system in all “21.21” metallic enclosure. Insulating “21.21” enclosures accept all “21.21” inserts.
- ☒ CGK-MGK IP68 enclosures (actually IP66/IP68/IP69) available both with 2-screw locking or by 2-bayonet locking (types with suffix B).



- ✓ UL certified for USA and Canada for Type 4, 4X and 12 degrees of protection (enclosure type ratings, equivalent to NEMA rating), printed on the packaging.  
**IP44** degree of protection, IP66/IP67/IP69 by using the special fixing screw + gasket kit CKR 65(D) separately available, and suitable cable outlet device.  
**IP66/IP68/IP69** degree of protection for CGK-MGK enclosures equipped with **CKR 65(D)** kit.

### ✎ Characteristics of materials for CK and MK series

- In self-extinguishing grey RAL 7035 or black thermoplastic material for insulating (CQ series only available black) or metallic enclosures;
- metal enclosures in die cast zinc or aluminium alloy, according to model;
- metal enclosures with epoxy-polyester thermosetting powder coating;
- gaskets in anti-aging, oil-resistant, grease-resistant and fuel-resistant NBR vinyl nitrile elastomer;
- metallic enclosures with single-block locking lever in stainless or galvanised steel;
- insulating enclosures with single-block locking lever in self-extinguishing thermoplastic material.



# CK - MK standard insulating version

inserts		page:
CK	3 poles + ⊕	58
CK	4 poles + ⊕	58
CKS	3 poles + ⊕	-
CKS	4 poles + ⊕	-
CKSH	3 poles + ⊕	63
CKSH	4 poles + ⊕	63
CD	7 poles + ⊕	66
CD	8 poles	67
CQ4	2 poles + ⊕	182
CQ4 H	2 poles + ⊕	183
CQ4	3 poles + ⊕	184
CQ	5 poles + ⊕	186
CQ	7 poles + ⊕	187
CQ	12 poles + ⊕	189
CQ	21 poles + ⊕	190

## bulkhead mounting housings



## angled bulkhead mounting housings

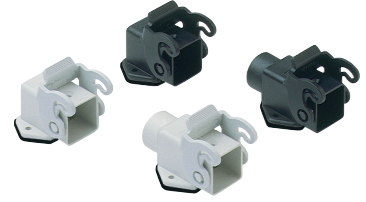

description	part No.	part No. (entry - Pg11)	part No. (entry - M20)
with lever	<b>CK 03 I</b> (white)		
with lever	<b>CK 03 IN</b> (black)		
without cable entry, with lever		<b>CK 03 IA</b> (white)	
without cable entry, with lever		<b>CK 03 IAN</b> (black)	
with cable entry and lever		<b>CK 03 IAPS</b> (white)	<b>MK IAP20</b> (white)
with cable entry and lever		<b>CK 03 IAPNS</b> (black)	<b>MK IAPN20</b> (black)
gasket and screw kit for IP66/IP67/IP69 1)	<b>CKR 65</b>	<b>CKR 65</b>	
gasket and screw kit for IP66/IP67/IP69 1) specific for CD 07/08 inserts	<b>CKR 65 D</b>	<b>CKR 65 D</b>	

1) To obtain the IP66/IP67/IP69 degree of protection, a kit with insert fixing screw and gasket can be purchased separately.  
Several inserts size "21.21" are already supplied with fixing screw and gasket, which ensures IP66/IP67/IP69 degree of protection. See list below, not including any special version:

- CQF/M 07, CQF/M 12
- CJ KF/M, CJF/M 4 /4/2 /8 /8/2
- CJK 8FT /8IFT /8MT /8IMT, CJK 8M
- CUK 2FT /3FT
- CX 1/2 BDF/M
- CLK 04 SCF /SCF-H /SCM
- CXL 2/4 PF /PM /PFH /PMH /SF /SM, CXL SF/M

NOTE: Housing type and colour may vary upon specific part No.

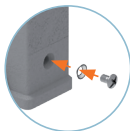

### panel cut-out for enclosures

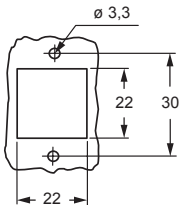

**CEC**®  
Type 12  
Type 4/4X only  
with CKR 65 (D)



IP66/IP67/IP69 with CKR 65 (D) 1)

### CK I - CK IN

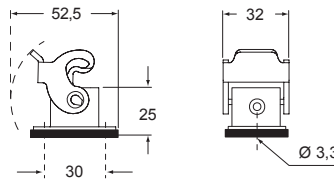

### CK IA - CK IAN

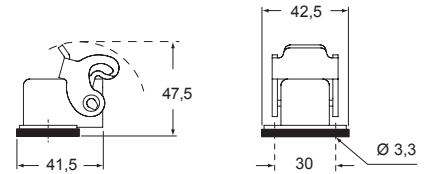

### CK IAPS - CK IAPSN and MK IAP - MK IAPN

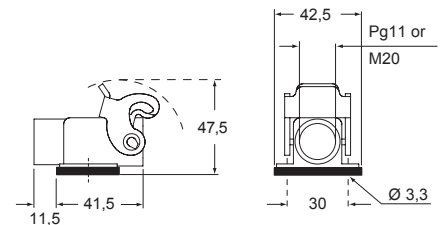

# CK - MK standard insulating version

inserts		page:
CK	3 poles + ⊕	58
CK	4 poles + ⊕	58
CKS	3 poles + ⊕	-
CKS	4 poles + ⊕	-
CKSH	3 poles + ⊕	63
CKSH	4 poles + ⊕	63
CD	7 poles + ⊕	66
CD	8 poles	67
CQ4	2 poles + ⊕	182
CQ4 H	2 poles + ⊕	183
CQ4	3 poles + ⊕	184
CQ	5 poles + ⊕	186
CQ	7 poles + ⊕	187
CQ	12 poles + ⊕	189
CQ	21 poles + ⊕	190

## hoods

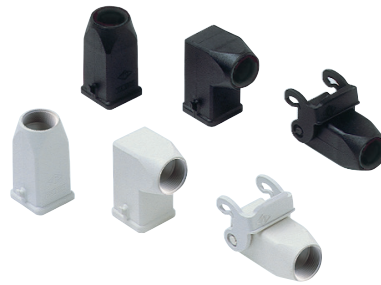

## covers



description	part No. (entry - Pg11)	part No. (entry - M20)	part No. (with eyelet)	part No. (with loop)
with pegs, top entry	<b>CK 03 VS</b> (white)	<b>MK V20</b> (white)		
with pegs, top entry	<b>CK 03 VNS</b> (black)	<b>MK VN20</b> (black)		
with pegs, side entry	<b>CK 03 VAS</b> (white)	<b>MK VA20</b> (white)		
with pegs, side entry	<b>CK 03 VANS</b> (black)	<b>MK VAN20</b> (black)		
with lever, top entry	<b>CK 03 VGS</b> (white)	<b>MK VG20</b> (white)		
with lever, top entry	<b>CK 03 VGNS</b> (black)	<b>MK VGN20</b> (black)		
with pegs and gasket, for female inserts			<b>CK 03 C</b> (white)	<b>CK 03 CS</b> (white)
with pegs and gasket, for female inserts			<b>CK 03 CN</b> (black)	
with pegs and gasket, for male inserts			<b>CK 03 CA</b> (white)	<b>CK 03 CAS</b> (white)
with pegs and gasket, for male inserts			<b>CK 03 CAN</b> (black)	
with lever and gasket, for female inserts				<b>CK 03 CX</b> (white)
with lever and gasket, for female inserts				<b>CK 03 CXN</b> (black)
with lever, for male inserts				<b>CK 03 CXA</b> (white)
with lever, for male inserts				<b>CK 03 CXAN</b> (black)
gasket and screw kit for IP66/IP67/IP69 1)	<b>CKR 65</b>			
gasket and screw kit for IP66/IP67/IP69 1) specific for CD 07/08 inserts	<b>CKR 65 D</b>			

1) To obtain the IP66/IP67/IP69 degree of protection, a kit with insert fixing screw and gasket can be purchased separately.  
Several inserts size "21.21" are already supplied with fixing screw and gasket, which ensures IP66/IP67/IP69 degree of protection. See list below, not including any special version:

- CQF/M 07, CQF/M 12
- CJ KF/M, CJF/M 4 /4/2 /8 /8/2
- CJK 8FT /8IFT /8MT /8IMT, CJK 8M
- CUK 2FT /3FT
- CX 1/2 BDF/M
- CLK 04 SCF /SCF-H /SCM
- CXL 2/4 PF /PM /PFH /PMH /SF /SM, CXL SF/M

NOTE: Housing type and colour may vary upon specific part No.

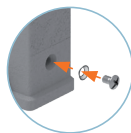

### CK VS - CK VNS and MK V - MK VN

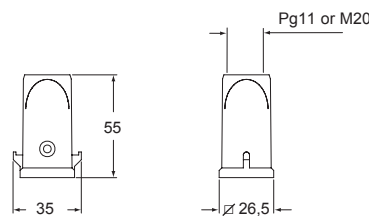

### CK VAS - CK VANS and MK VA - MK VAN

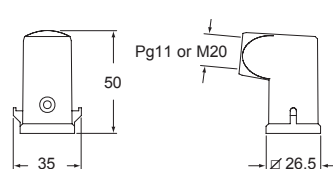

### CK VGS - CK VGNS and MK VG - MK VGN

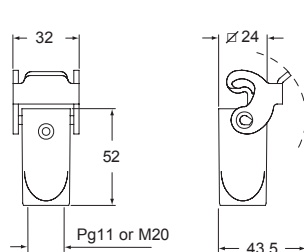

### CK C - CK CN - CK CS

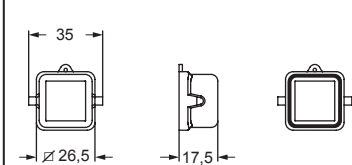

### CK CA - CK CAN - CK CAS

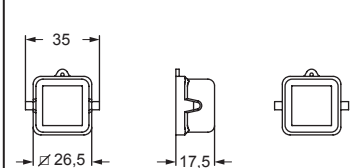

### CK CX - CK CXN

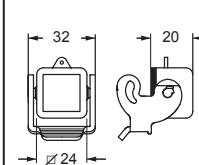

### CK CXA - CK CXAN

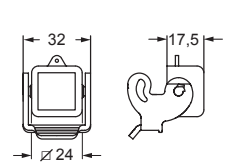

For fixing on housings

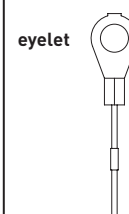

For fixing on hoods

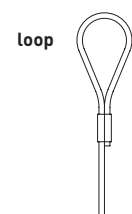

**CAIUS** Type 12  
Type 4/4X only  
with CKR 65 (D)



IP66/IP67/IP69 with CKR 65 (D) 1)

# MK standard insulating version

inserts	page:
CK 3 and 4 poles + ⊕	58
CKS 3 and 4 poles + ⊕	-
CKSH 3 and 4 poles + ⊕	63
CD 7 poles + ⊕	66
CD 8 poles	67
CQ4 2 poles + ⊕	182
CQ4 H 2 poles + ⊕	183
CQ4 3 poles + ⊕	184
CQ 5 poles + ⊕	186
CQ 7 poles + ⊕	187
CQ 12 poles + ⊕	189
CQ 21 poles + ⊕	190
CJ KM	305
CJK 8MT	308
CJK 8IMT	308
CLK 04 SC	321
CX 1/2 BD	325
CXL 2/4 SF/SM	332
CXL SF/SM	332
CXL 2/4 PF/PM	333
CXL 2/4 PFH/PMH	333
CXL PF/PM	333

## hoods



## hoods



description	part No. (entry - M25)	part No. (entry - M25)
with pegs, top entry	<b>MK V25</b> (light grey RAL 7035)	<b>MK VN25</b> (black)
with pegs, top entry		
gasket and screw kit for IP66/IP67/IP69 1)	<b>CKR 65</b>	<b>CKR 65</b>
gasket and screw kit for IP66/IP67/IP69 1) specific for CD 08 inserts	<b>CKR 65 D</b>	<b>CKR 65 D</b>

1) To obtain the IP66/IP67/IP69 degree of protection, a kit with insert fixing screw and gasket can be purchased separately.  
Several inserts size "21.21" are already supplied with fixing screw and gasket, which ensures IP66/IP67/IP69 degree of protection. See list below, not including any special version:

- CQF/M 07, CQF/M 12
- CJ KF/M, CJF/M 4 /4/2 /8 /8/2
- CJK 8FT /8IFT /8MT /8IMT, CJK 8M
- CUK 2FT /3FT
- CX 1/2 BDF/M
- CLK 04 SCF /SCF-H /SCM
- CXL 2/4 PF /PM /PFH /PMH /SF /SM, CXL SF/M

NOTE: Housing type and colour may vary upon specific part No.

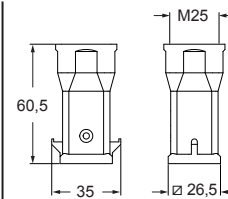
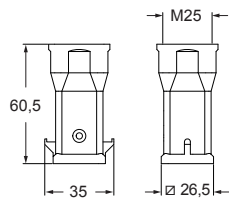
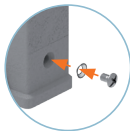

cURus  
Type 12 / Type 4/4X only with CKR 65 (D) pending



IP66/IP67/IP69 with CKR 65 (D) 1)

**MK standard insulating version**

inserts	page:
CK	3 and 4 poles + ⊕ 58
CKS	3 and 4 poles + ⊕ -
CKSH	3 and 4 poles + ⊕ 63
CD	7 poles + ⊕ 66
CD	8 poles 67
CQ4	2 poles + ⊕ 182
CQ4 H	2 poles + ⊕ 183
CQ4	3 poles + ⊕ 184
CQ	5 poles + ⊕ 186
CQ	7 poles + ⊕ 187
CQ	12 poles + ⊕ 189
CQ	21 poles + ⊕ 190
CJ KM	305
CJK 8MT	308
CJK 8IMT	308
CLK 04 SC	321
CX 1/2 BD	325
CXL 2/4 SF/SM	332
CXL SF/SM	332
CXL 2/4 PF/PM	333
CXL 2/4 PFH/PMH	333
CXL PF/PM	333

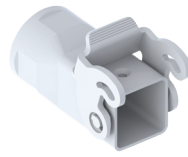
**insulating hoods**

description	part No. (entry - M25)
with lever, top entry	<b>MK VG25</b> (light grey RAL 7035)
gasket and screw kit for IP66/IP67/IP69 1)	<b>CKR 65</b>
gasket and screw kit for IP66/IP67/IP69 1) specific for CD 08 inserts	<b>CKR 65 D</b>

1) To obtain the IP66/IP67/IP69 degree of protection, a kit with insert fixing screw and gasket can be purchased separately.  
Several inserts size "21.21" are already supplied with fixing screw and gasket, which ensures IP66/IP67/IP69 degree of protection. See list below, not including any special version:

- CQF/M 07, CQF/M 12
- CJ KF/M, CJF/M 4 /4/2 /8 /8/2
- CJK 8FT /8IFT /8MT /8IMT, CJK 8M
- CUK 2FT /3FT
- CX 1/2 BDF/M
- CLK 04 SCF /SCF-H /SCM
- CXL 2/4 PF /PM /PFH /PMH /SF /SM, CXL SF/M

NOTE: Housing type and colour may vary upon specific part No.

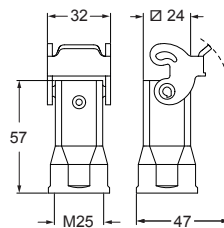
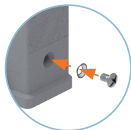

cURus  
Type 12 / Type 4/4X only with CKR 65 (D) pending



IP44 IP66/IP67/IP69 with CKR 65 (D) 1)

# MK standard insulating version

inserts	page:
CK 3 and 4 poles + ⊕	58
CKS 3 and 4 poles + ⊕	-
CKSH 3 and 4 poles + ⊕	63
CD 7 poles + ⊕	66
CD 8 poles	67
CQ4 2 poles + ⊕	182
CQ4 H 2 poles + ⊕	183
CQ4 3 poles + ⊕	184
CQ 5 poles + ⊕	186
CQ 7 poles + ⊕	187
CQ 12 poles + ⊕	189
CQ 21 poles + ⊕	190
CJ KM	305
CJK 8MT	308
CJK 8IMT	308
CLK 04 SC	321
CX 1/2 BD	325
CXL 2/4 SF/SM	332
CXL SF/SM	332
CXL 2/4 PF/PM	333
CXL 2/4 PFH/PMH	333
CXL PF/PM	333

## insulating hoods



description	part No. (entry - M25)
with lever, top entry	<b>MK VGN25</b> (black)
gasket and screw kit for IP66/IP67/IP69 1)	<b>CKR 65</b>
gasket and screw kit for IP66/IP67/IP69 1) specific for CD 08 inserts	<b>CKR 65 D</b>

1) To obtain the IP66/IP67/IP69 degree of protection, a kit with insert fixing screw and gasket can be purchased separately.

Several inserts size "21.21" are already supplied with fixing screw and gasket, which ensures IP66/IP67/IP69 degree of protection. See list below, not including any special version:

- CQF/M 07, CQF/M 12
- CJ KF/M, CJF/M 4 /4/2 /8 /8/2
- CJK 8FT /8IFT /8MT /8IMT, CJK 8M
- CUK 2FT /3FT
- CX 1/2 BDF/M
- CLK 04 SCF /SCF-H /SCM
- CXL 2/4 PF /PM /PFH /PMH /SF /SM, CXL SF/M

NOTE: Housing type and colour may vary upon specific part No.

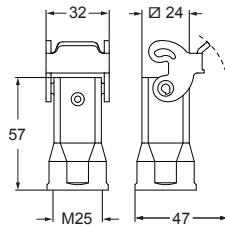
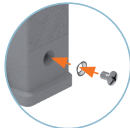

cURus  
Type 12 / Type 4/4X only with CKR 65 (D) pending



IP44 IP66/IP67/IP69 with CKR 65 (D) 1)

# CKX standard insulating version

inserts		page:
CK	3 poles + ⊕	58
CK	4 poles + ⊕	58
CKS	3 poles + ⊕	-
CKS	4 poles + ⊕	-
CKSH	3 poles + ⊕	63
CKSH	4 poles + ⊕	63
CD	7 poles + ⊕	66
CD	8 poles	67
CQ4	2 poles + ⊕	182
CQ4 H	2 poles + ⊕	183
CQ4	3 poles + ⊕	184
CQ	5 poles + ⊕	186
CQ	7 poles + ⊕	187
CQ	12 poles + ⊕	189
CQ	21 poles + ⊕	190

## bulkhead mounting housings



## angled bulkhead mounting housings



description	part No.	part No. (entry - Pg11)
with stainless steel lever	<b>CKX 03 I</b> (white)	<b>CKX 03 IA</b>
with stainless steel lever	<b>CKX 03 IN</b> (black)	
without cable entry, with stainless steel lever		<b>CKX 03 IAP</b>
with cable entry and stainless steel lever		<b>CKX 03 IAPS</b>
with cable entry and stainless steel lever		<b>CKR 65</b>
gasket and screw kit for IP66/IP67/IP69 1)	<b>CKR 65</b>	<b>CKR 65</b>
gasket and screw kit for IP66/IP67/IP69 1) specific for CD 07/08 inserts	<b>CKR 65 D</b>	<b>CKR 65 D</b>

1) To obtain the IP66/IP67/IP69 degree of protection, a kit with insert fixing screw and gasket can be purchased separately.  
Several inserts size "21.21" are already supplied with fixing screw and gasket, which ensures IP66/IP67/IP69 degree of protection. See list below, not including any special version:

- CQF/M 07, CQF/M 12
- CJ KF/M, CJF/M 4 /4/2 /8 /8/2
- CJK 8FT /8IFT /8MT /8IMT, CJK 8M
- CUK 2FT /3FT
- CX 1/2 BDF/M
- CLK 04 SCF /SCF-H /SCM
- CXL 2/4 PF /PM /PFH /PMH /SF /SM, CXL SF/M

NOTE: Housing type and colour may vary upon specific part No.

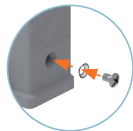

### CKX I - CKX IN

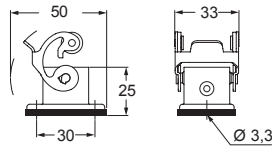

### CKX IA

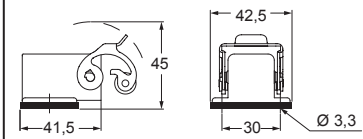

### CKX IAP - CKX IAPS

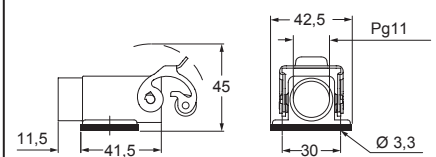

### panel cut-out for enclosures

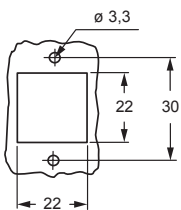

IP66/IP67/IP69 with CKR 65 (D) 1)

CKX



# CKX standard insulating version

inserts		page:
CK	3 poles + ⊕	58
CK	4 poles + ⊕	58
CKS	3 poles + ⊕	-
CKS	4 poles + ⊕	-
CKSH	3 poles + ⊕	63
CKSH	4 poles + ⊕	63
CD	7 poles + ⊕	66
CD	8 poles	67
CQ4	2 poles + ⊕	182
CQ4 H	2 poles + ⊕	183
CQ4	3 poles + ⊕	184
CQ	5 poles + ⊕	186
CQ	7 poles + ⊕	187
CQ	12 poles + ⊕	189
CQ	21 poles + ⊕	190

## hoods

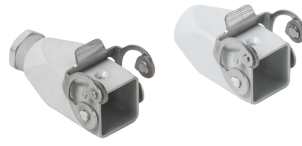

description	part No. (entry - Pg11)
with stainless steel lever, top entry	<b>CKX 03 VG</b>
without cable entry and stainless steel lever, top entry	<b>CKX 03 VGS</b>
gasket and screw kit for IP66/IP67/IP69 1)	<b>CKR 65</b>
gasket and screw kit for IP66/IP67/IP69 1) specific for CD 07/08 inserts	<b>CKR 65 D</b>

1) To obtain the IP66/IP67/IP69 degree of protection, a kit with insert fixing screw and gasket can be purchased separately.  
Several inserts size "21.21" are already supplied with fixing screw and gasket, which ensures IP66/IP67/IP69 degree of protection. See list below, not including any special version:

- CQF/M 07, CQF/M 12
- CJ KF/M, CJF/M 4 /4/2 /8 /8/2
- CJK 8FT /8IFT /8MT /8IMT, CJK 8M
- CUK 2FT /3FT
- CX 1/2 BDF/M
- CLK 04 SCF /SCF-H /SCM
- CXL 2/4 PF /PM /PFH /PMH /SF /SM, CXL SF/M

NOTE: Housing type and colour may vary upon specific part No.

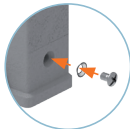

## CKX VG - CKX VGS

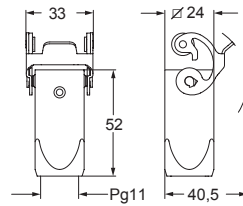

IP44 IP66/IP67/IP69 with CKR 65 (D) 1)

**CK - CKG standard insulating version DESINA®**

inserts	page:
CJ KF	305
CJK 8FT	308
CJK 8IFT	310
CLK 04 SC	321
CXL 2/4 SF	332
CXL 2/4 SM	332
CXL SF	332
CXL SM	332

**bulkhead mounting housings**



**cover**



description

part No.

part No.

with lever

**CK 03 IN** (black)

with pegs and gasket

**CKG 03 CN** (black)

1) To obtain the IP66/IP67/IP69 degree of protection, a kit with insert fixing screw and gasket can be purchased separately.  
Several inserts size "21.21" are already supplied with fixing screw and gasket, which ensures IP66/IP67/IP69 degree of protection. See list below, not including any special version:

- CQF/M 07, CQF/M 12
- CJ KF/M, CJF/M 4 /4/2 /8 /8/2
- CJK 8FT /8IFT /8MT /8IMT, CJK 8M
- CUK 2FT /3FT
- CX 1/2 BDF/M
- CLK 04 SCF /SCF-H /SCM
- CXL 2/4 PF /PM /PFH /PMH /SF /SM, CXL SF/M

NOTE: Housing type and colour may vary upon specific part No.

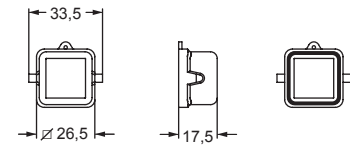
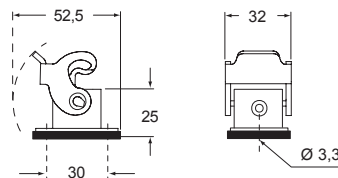
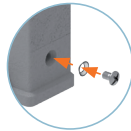

panel cut-out for enclosures

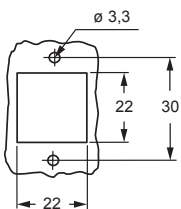

**CAUS**® Type 4/4X/12



CK - CKG DESINA®

# CKG - MKG standard insulating version DESINA®

inserts	page:
CJ KM	305
CJK 8MT	308
CJK 8IMT *	308
CLK 04 SC *	321
CXL 2/4 PF	333
CXL 2/4 PFH	333
CXL 2/4 PM	333
CXL 2/4 PMH	333
CXL PF	333
CXL PM	333

\* cannot be used with angled enclosures  
(part No. CKG 03 VA / MKG VA20)

## hoods



description	part No. (entry - Pg11)	part No. (entry - M20)
with pegs and gasket, top entry	<b>CKG 03 VN</b> (black)	<b>MKG VN20</b> (black)
with pegs and gasket, side entry	<b>CKG 03 VAN</b> (black)	<b>MKG VAN20</b> (black)

1) To obtain the IP66/IP67/IP69 degree of protection, a kit with insert fixing screw and gasket can be purchased separately.  
Several inserts size "21.21" are already supplied with fixing screw and gasket, which ensures IP66/IP67/IP69 degree of protection. See list below, not including any special version:

- CQF/M 07, CQF/M 12
- CJ KF/M, CJF/M 4 /4/2 /8 /8/2
- CJK 8FT /8IFT /8MT /8IMT, CJK 8M
- CUK 2FT /3FT
- CX 1/2 BDF/M
- CLK 04 SCF /SCF-H /SCM
- CXL 2/4 PF /PM /PFH /PMH /SF /SM, CXL SF/M

NOTE: Housing type and colour may vary upon specific part No.

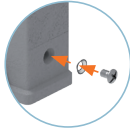

### CKG VN and MKG VN

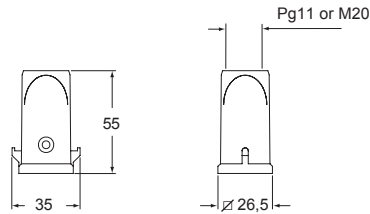

### CKG VAN and MKG VAN

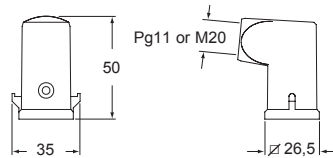

Type 4/4X/12



# MKG standard insulating version with glued gasket

inserts		page:
CK	3 and 4 poles + ⊕	58
CKS	3 and 4 poles + ⊕	-
CKSH	3 and 4 poles + ⊕	63
CD	7 poles + ⊕	66
CD	8 poles	67
CQ4	2 poles + ⊕	182
CQ4 H	2 poles + ⊕	183
CQ4	3 poles + ⊕	184
CQ	5 poles + ⊕	186
CQ	7 poles + ⊕	187
CQ	12 poles + ⊕	189
CQ	21 poles + ⊕	190
CJ KM		305
CJK 8M		315
CJK 8MT		308
CJK 8IMT		308
CLK 04 SC		321
CX 1/2 BD		325
CXL 2/4 SF/SM		332
CXL SF/SM		332
CXL 2/4 PF/PM		333
CXL 2/4 PFH/PMH		333
CXL PF/PM		333

## hoods with glued gasket



## hoods with glued gasket



description	part No. (entry - M25)	part No. (entry - M25)
with pegs and glued gasket, top entry	<b>MKG V25</b> (light grey RAL 7035)	<b>MKG VN25</b> (black)
gasket and screw kit for IP66/IP67/IP69 1)	<b>CKR 65</b>	<b>CKR 65</b>
gasket and screw kit for IP66/IP67/IP69 1) specific for CD 08 inserts	<b>CKR 65 D</b>	<b>CKR 65 D</b>

1) To obtain the IP66/IP67/IP69 degree of protection, a kit with insert fixing screw and gasket can be purchased separately.  
Several inserts size "21.21" are already supplied with fixing screw and gasket, which ensures IP66/IP67/IP69 degree of protection. See list below, not including any special version:

- CQF/M 07, CQF/M 12
- CJ KF/M, CJF/M 4 /4/2 /8 /8/2
- CJK 8FT /8IFT /8MT /8IMT, CJK 8M
- CUK 2FT /3FT
- CX 1/2 BDF/M
- CLK 04 SCF /SCF-H /SCM
- CXL 2/4 PF /PM /PFH /PMH /SF /SM, CXL SF/M

NOTE: Housing type and colour may vary upon specific part No.

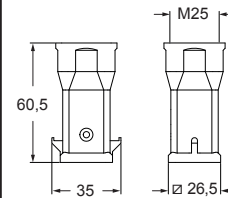
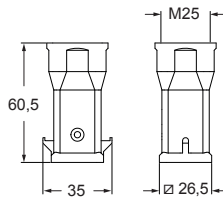
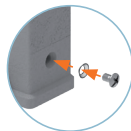

cURus  
Type 12 / Type 4/4X only with CKR 65 (D) pending



IP66/IP67/IP69 with CKR 65 (D) 1)

# CKA - MKA standard metallic version

inserts		page:
CK	3 poles + ⊕	58
CK	4 poles + ⊕	58
CKS	3 poles + ⊕	-
CKS	4 poles + ⊕	-
CKSH	3 poles + ⊕	63
CKSH	4 poles + ⊕	63
CD	8 poles	67
CQ4	2 poles + ⊕	182
CQ4 H	2 poles + ⊕	183
CQ4	3 poles + ⊕	184
CQ	5 poles + ⊕	186
CQ	7 poles + ⊕	187
CQ	12 poles + ⊕	189
CQ	21 poles + ⊕	190

## bulkhead mounting housings



## angled bulkhead mounting housings

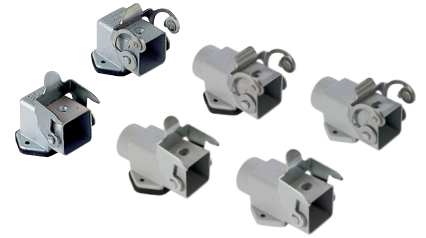

description	part No.	part No. (entry - Pg11)	part No. (entry - M20)
with galvanised steel lever	<b>CKA 03 I</b>		
with stainless steel lever	<b>CKAX 03 I</b>		
without cable entry, galvanised steel lever		<b>CKA 03 IA</b>	
without cable entry, stainless steel lever		<b>CKAX 03 IA</b>	
with cable entry, galvanised steel lever		<b>CKA 03 IAPS</b>	<b>MKA IAP20</b>
with cable entry, stainless steel lever		<b>CKAX 03 IAPS</b>	<b>MKAX IAP20</b>
with cable entry, galvanised steel lever, bulkhead hole closed		<b>CKA 03 APS</b>	<b>MKA AP20</b>
with cable entry, stainless steel lever, bulkhead hole closed		<b>CKAX 03 APS</b>	<b>MKAX AP20</b>
gasket and screw kit for IP66/IP67/IP69 1)	<b>CKR 65</b>	<b>CKR 65</b>	
gasket and screw kit for IP66/IP67/IP69 1) specific for CD 08 inserts	<b>CKR 65 D</b>	<b>CKR 65 D</b>	

1) To obtain the IP66/IP67/IP69 degree of protection, a kit with insert fixing screw and gasket can be purchased separately.  
Several inserts size "21.21" are already supplied with fixing screw and gasket, which ensures IP66/IP67/IP69 degree of protection. See list below, not including any special version:

- CQF/M 07, CQF/M 12
- CJ KF/M, CJF/M 4 /4/2 /8 /8/2
- CJK 8FT /8IFT /8MT /8IMT, CJK 8M
- CUK 2FT /3FT
- CX 1/2 BDF/M
- CLK 04 SCF /SCF-H /SCM
- CXL 2/4 PF /PM /PFH /PMH /SF /SM, CXL SF/M

NOTE: Housing type and colour may vary upon specific part No.

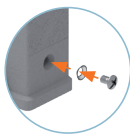

panel cut-out for enclosures

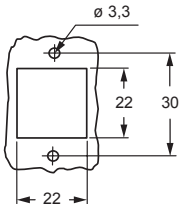

### CKA I

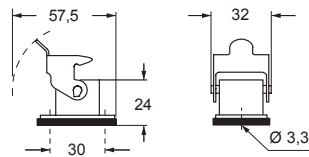

### CKAX I

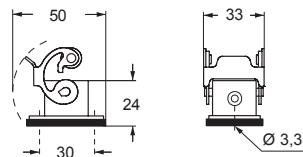

### CKA IA

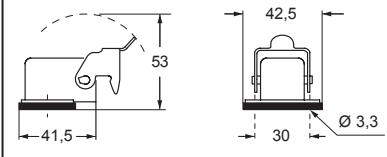

### CKAX IA

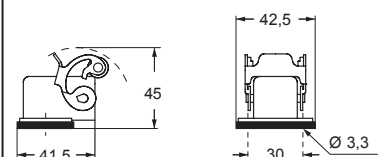

### CKA IAPS (CKA APS) and MKA IAP (MKA AP)

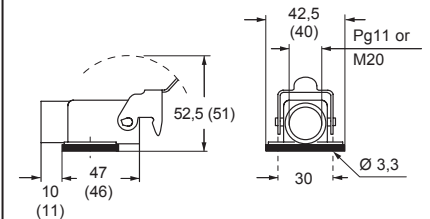

### CKAX IAPS (CKAX APS) and MKAX IAP (MKAX AP)

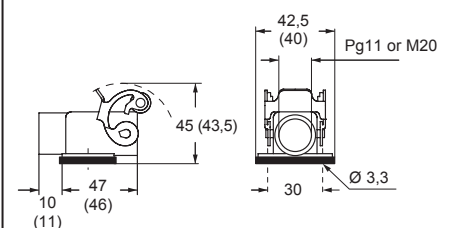

Type 12  
Type 4/4X only  
with CKR 65 (D)



IP66/IP67/IP69 with CKR 65 (D) 1)

# CKA - MKA standard metallic version

inserts		page:
CK	3 poles + ⊕	58
CK	4 poles + ⊕	58
CKS	3 poles + ⊕	-
CKS	4 poles + ⊕	-
CKSH	3 poles + ⊕	63
CKSH	4 poles + ⊕	63
CD	8 poles	67
CQ4	2 poles + ⊕	182
CQ4 H	2 poles + ⊕	183
CQ4	3 poles + ⊕	184
CQ	5 poles + ⊕	186
CQ	7 poles + ⊕	187
CQ	12 poles + ⊕	189
CQ	21 poles + ⊕	190

## angled bulkhead mounting housings

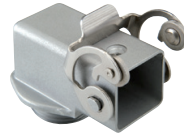

## bulkhead mounting housings with SELF-CLOSING cover



description	part No. (entry - M20 / M25)	part No.
galvanized steel lever, M20 fixing thread <sup>(1)</sup>	<b>MKA IAF20</b>	
stainless steel lever, M20 fixing thread <sup>(1)</sup>	<b>MKAX IAF20</b>	
galvanized steel lever, M25 fixing thread <sup>(1)</sup>	<b>MKA IAF25</b>	
stainless steel lever, M25 fixing thread <sup>(1)</sup>	<b>MKAX IAF25</b>	
with stainless steel lever, for female inserts		<b>CKAX 03 ILS</b>
with stainless steel lever and gasket, for male inserts		<b>CKAX 03 ILSA</b>
with galvanised steel lever, for female inserts		<b>CKA 03 ILS</b>
with galvanised steel lever and gasket, for male inserts		<b>CKA 03 ILSA</b>
gasket and screw kit for IP66/IP67/IP69 <sup>1)</sup>	<b>CKR 65</b>	<b>CKR 65</b>
gasket and screw kit for IP66/IP67/IP69 <sup>1)</sup> specific for CD 08 inserts	<b>CKR 65 D</b>	<b>CKR 65 D</b>

<sup>1)</sup> To obtain the IP66/IP67/IP69 degree of protection, a kit with insert fixing screw and gasket can be purchased separately.  
Several inserts size "21.21" are already supplied with fixing screw and gasket, which ensures IP66/IP67/IP69 degree of protection. See list below, not including any special version:

- CQF/M 07, CQF/M 12
- CJ KF/M, CJF/M 4 /4/2 /8 /8/2
- CJK 8FT /8IFT /8MT /8IMT, CJK 8M
- CUK 2FT /3FT
- CX 1/2 BDF/M
- CLK 04 SCF /SCF-H /SCM
- CXL 2/4 PF /PM /PFH /PMH /SF /SM, CXL SF/M.

NOTE: Housing type and colour may vary upon specific part No.

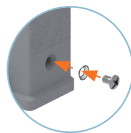

panel cut-out for enclosures CKA ILS/ILSA

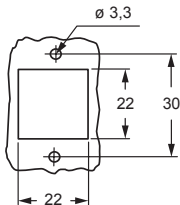

### MKA IAF

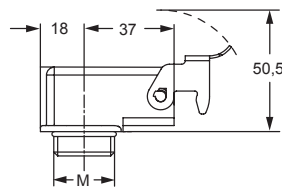

### MKAX IAF

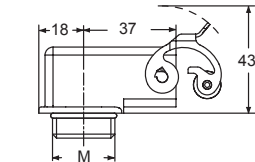

panel cut-out

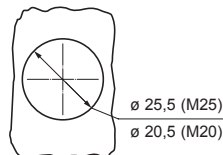

### USE OF THE LOCHNUT

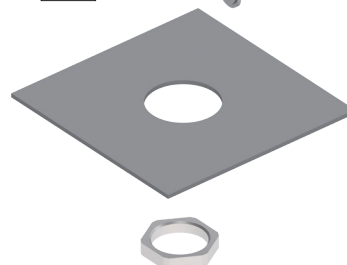
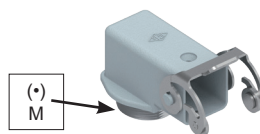

### CKA ILS

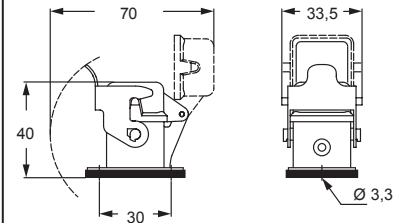

### CKA ILSA

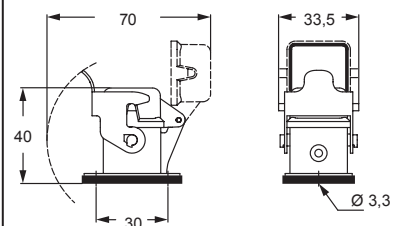

### CKAX ILS

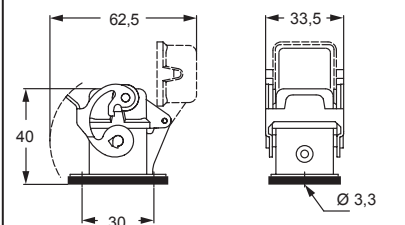

### CKAX ILSA

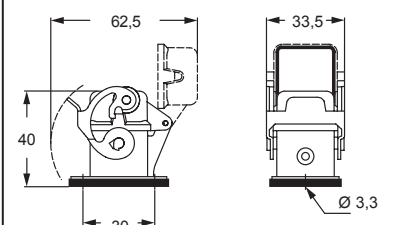

Type 12  
Type 4/4X only  
with CKR 65 (D)



IP66/IP67/IP69 with CKR 65 (D) <sup>1)</sup>

CKA - MKA



# CKA - MKA standard metallic version

inserts		page:
CK	3 poles + ⊕	58
CK	4 poles + ⊕	58
CKS	3 poles + ⊕	-
CKS	4 poles + ⊕	-
CKSH	3 poles + ⊕	63
CKSH	4 poles + ⊕	63
CD	8 poles	67
CQ4	2 poles + ⊕	182
CQ4 H	2 poles + ⊕	183
CQ4	3 poles + ⊕	184
CQ	5 poles + ⊕	186
CQ	7 poles + ⊕	187
CQ	12 poles + ⊕	189
CQ	21 poles + ⊕	190

## hoods

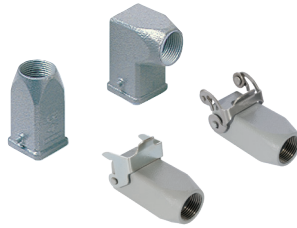

## covers

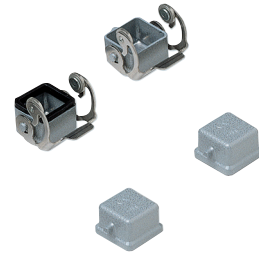

description	part No. (entry - Pg11)	part No. (entry - M20)	part No. (with eyelet)	part No. (with loop)
with pegs, top entry	<b>CKA 03 VS</b>	<b>MKA V20</b>		
with pegs, side entry	<b>CKA 03 VAS</b>	<b>MKA VA20</b>		
with galvanised steel lever, top entry	<b>CKA 03 VGS</b>	<b>MKA VG20</b>		
with stainless steel lever, top entry	<b>CKAX 03 VGS</b>	<b>MKAX VG20</b>		
with pegs and gasket, for female inserts			<b>CKA 03 C 2)</b>	<b>CKA 03 CS 2)</b>
with pegs, for male inserts			<b>CKA 03 CA 2)</b>	<b>CKA 03 CAS 2)</b>
with stainless steel lever and gasket, for female inserts				<b>CKAX 03 CX</b>
with stainless steel lever, for male inserts				<b>CKAX 03 CXA</b>
gasket and screw kit for IP66/IP67/IP69 1)	<b>CKR 65</b>		<b>CKR 65</b>	
gasket and screw kit for IP66/IP67/IP69 1) specific for CD 08 inserts	<b>CKR 65 D</b>		<b>CKR 65 D</b>	

1) To obtain the IP66/IP67/IP69 degree of protection, a kit with insert fixing screw and gasket can be purchased separately.  
Several inserts size "21.21" are already supplied with fixing screw and gasket, which ensures IP66/IP67/IP69 degree of protection. See list below, not including any special version:

- CQF/M 07, CQF/M 12
- CJ KF/M, CJF/M 4 /4/2 /8 /8/2
- CJK 8FT /8IFT /8MT /8IMT, CJK 8M
- CUK 2FT /3FT
- CX 1/2 BDF/M
- CLK 04 SCF /SCF-H /SCM
- CXL 2/4 PF /PM /PFH /PMH /SF /SM, CXL SF/M

NOTE: Housing type and colour may vary upon specific part No.

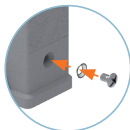

### CKA VS and MKA V

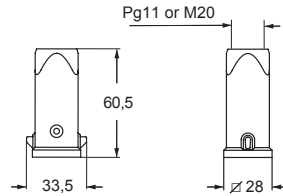

### CKA VAS and MKA VA

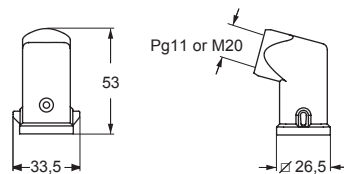

### CKA VGS and MKA VG

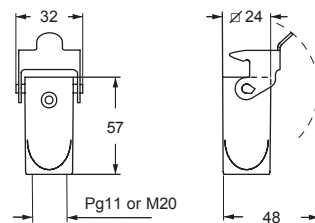

### CKAX VGS and MKAX VG

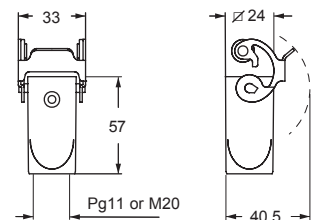

2) Preferably be used with enclosures CKAX (stainless steel lever).

### CKA C - CKA CS

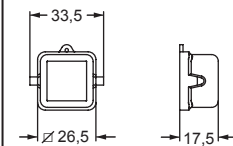

### CKA CA - CKA CAS

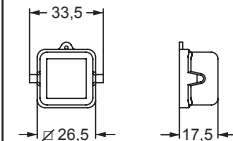

### CKAX CX

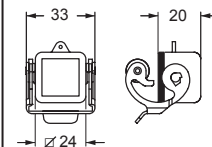

### CKAX CXA

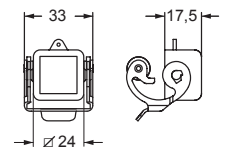

### For fixing on housings

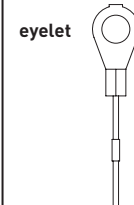

### For fixing on hoods

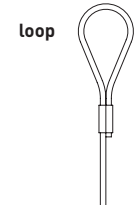

**CE** **UL** **US** Type 12  
Type 4/4X only  
with CKR 65 (D)



IP66/IP67/IP69 with CKR 65 (D) 1)

# MKA standard metallic version

inserts		page:
CK	3 poles + ⊕	58
CK	4 poles + ⊕	58
CKS	3 poles + ⊕	-
CKS	4 poles + ⊕	-
CKSH	3 poles + ⊕	63
CKSH	4 poles + ⊕	63
CD	8 poles	67
CQ4	2 poles + ⊕	182
CQ4 H	2 poles + ⊕	183
CQ4	3 poles + ⊕	184
CQ	5 poles + ⊕	186
CQ	7 poles + ⊕	187
CQ	12 poles + ⊕	189
CQ	21 poles + ⊕	190

## hoods



description	part No. (entry - M25)
with pegs, top entry	<b>MKA V25</b>
gasket and screw kit for IP66/IP67/IP69 1)	<b>CKR 65</b>
gasket and screw kit for IP66/IP67/IP69 1) specific for CD 08 inserts	<b>CKR 65 D</b>

1) To obtain the IP66/IP67/IP69 degree of protection, a kit with insert fixing screw and gasket can be purchased separately.  
Several inserts size "21.21" are already supplied with fixing screw and gasket, which ensures IP66/IP67/IP69 degree of protection. See list below, not including any special version:

- CQF/M 07, CQF/M 12
- CJ KF/M, CJF/M 4 /4/2 /8 /8/2
- CJK 8FT /8IFT /8MT /8IMT, CJK 8M
- CUK 2FT /3FT
- CX 1/2 BDF/M
- CLK 04 SCF /SCF-H /SCM
- CXL 2/4 PF /PM /PFH /PMH /SF /SM, CXL SF/M

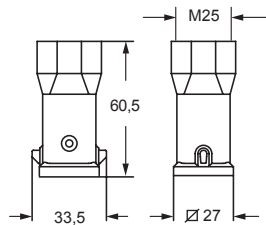

NOTE: Housing type and colour may vary upon specific part No.

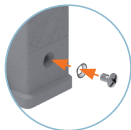

Type 12  
Type 4/4X only  
with CKR 65 (D)



IP66/IP67/IP69 with CKR 65 (D) 1)

MKA

# MKAG standard metallic version with glued gasket

inserts		page:
CK	3 poles + ⊕	58
CK	4 poles + ⊕	58
CKS	3 poles + ⊕	-
CKS	4 poles + ⊕	-
CKSH	3 poles + ⊕	63
CKSH	4 poles + ⊕	63
CD	8 poles	67
CQ4	2 poles + ⊕	182
CQ4 H	2 poles + ⊕	183
CQ4	3 poles + ⊕	184
CQ	5 poles + ⊕	186
CQ	7 poles + ⊕	187
CQ	12 poles + ⊕	189
CQ	21 poles + ⊕	190

## hoods with glued gasket



description	part No. (entry - M25)
with pegs and glued gasket, top entry	<b>MKAG V25</b>
gasket and screw kit for IP66/IP67/IP69 <sup>1)</sup>	<b>CKR 65</b>
gasket and screw kit for IP66/IP67/IP69 <sup>1)</sup> specific for CD 08 inserts	<b>CKR 65 D</b>

<sup>1)</sup> To obtain the IP66/IP67/IP69 degree of protection, a kit with insert fixing screw and gasket can be purchased separately.  
Several inserts size "21.21" are already supplied with fixing screw and gasket, which ensures IP66/IP67/IP69 degree of protection. See list below, not including any special version:

- CQF/M 07, CQF/M 12
- CJ KF/M, CJF/M 4 /4/2 /8 /8/2
- CJK 8FT /8IFT /8MT /8IMT, CJK 8M
- CUK 2FT /3FT
- CX 1/2 BDF/M
- CLK 04 SCF /SCF-H /SCM
- CXL 2/4 PF /PM /PFH /PMH /SF /SM, CXL SF/M

NOTE: Housing type and colour may vary upon specific part No.

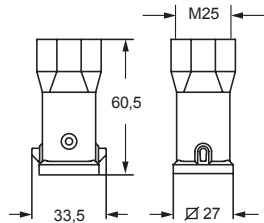
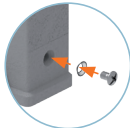

**CEC**®  
**US**

Type 12  
Type 4/4X only  
with CKR 65 (D)



IP66/IP67/IP69 with CKR 65 (D) <sup>1)</sup>

**CKA standard metallic version DESINA®**

inserts	page:
CJ KF	305
CJK 8FT	308
CJK 8IFT	310
CLK 04 SC	321
CX 1/2 BD	325
CXL 2/4 SF	332
CXL 2/4 SM	332
CXL SF	332
CXL SM	332

**bulkhead mounting housings cover**

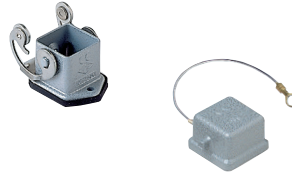

**bulkhead mounting housings with SELF-CLOSING cover**



description	part No.	part No.
with stainless steel lever	<b>CKAX 03 I</b>	
with pegs and gasket	<b>CKAG 03 C</b>	
with stainless steel lever, for female inserts		<b>CKAX 03 ILS</b>

1) To obtain the IP66/IP67/IP69 degree of protection, a kit with insert fixing screw and gasket can be purchased separately. Several inserts size "21.21" are already supplied with fixing screw and gasket, which ensures IP66/IP67/IP69 degree of protection. See list below, not including any special version:

- CQF/M 07, CQF/M 12
- CJ KF/M, CJF/M 4 /4/2 /8 /8/2
- CJK 8FT /8IFT /8MT /8IMT, CJK 8M
- CUK 2FT /3FT
- CX 1/2 BDF/M
- CLK 04 SCF /SCF-H /SCM
- CXL 2/4 PF /PM /PFH /PMH /SF /SM, CXL SF/M

NOTE: Housing type and colour may vary upon specific part No.

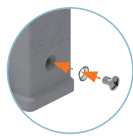

**CKAX I**

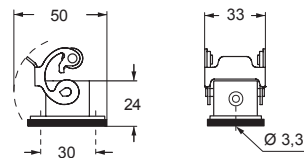

**CKAG C**

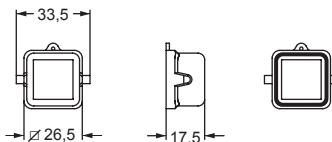

**CKAX 03 ILS**

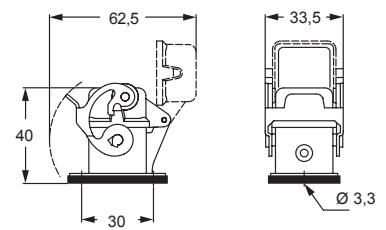

panel cut-out for enclosures

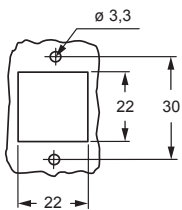

**CAUS**® Type 4/4X/12



CKA DESINA®

**CKA - MKA standard metallic version DESINA®**

inserts	page:
CJ KM	305
CJK 8MT	308
CJK 8IMT *	308
CLK 04 SC *	321
CX 1/2 BD	325
CXL 2/4 PF	333
CXL 2/4 PFH	333
CXL 2/4 PM	333
CXL 2/4 PMH	333
CXL PF	333
CXL PM	333

\* cannot be used with angled enclosures  
(part No. CKAG 03 VA / MKAG VA20)

**hoods**

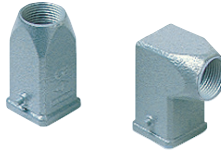

description	part No. (entry - Pg11)	part No. (entry - M20)
with pegs and gasket, top entry	<b>CKAG 03 V</b>	<b>MKAG V20</b>
with pegs and gasket, side entry	<b>CKAG 03 VA</b>	<b>MKAG VA20</b>

1) To obtain the IP66/IP67/IP69 degree of protection, a kit with insert fixing screw and gasket can be purchased separately.  
Several inserts size "21.21" are already supplied with fixing screw and gasket, which ensures IP66/IP67/IP69 degree of protection. See list below, not including any special version:

- CQF/M 07, CQF/M 12
- CJ KF/M, CJF/M 4 /4/2 /8 /8/2
- CJK 8FT /8IFT /8MT /8IMT, CJK 8M
- CUK 2FT /3FT
- CX 1/2 BDF/M
- CLK 04 SCF /SCF-H /SCM
- CXL 2/4 PF /PM /PFH /PMH /SF /SM, CXL SF/M

NOTE: Housing type and colour may vary upon specific part No.

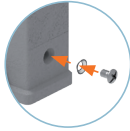

**CKAG V and MKAG V**

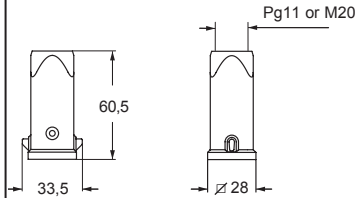

**CKAG VA and MKAG VA**

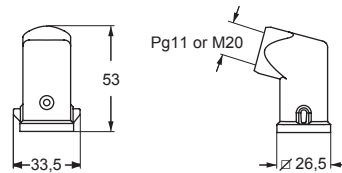

**CEC®** Type 4/4X/12



# CKAX standard metallic version

inserts		page:
CK	3 poles + ⊕	58
CK	4 poles + ⊕	58
CKS	3 poles + ⊕	-
CKS	4 poles + ⊕	-
CKSH	3 poles + ⊕	63
CKSH	4 poles + ⊕	63
CD	8 poles	67
CQ4	2 poles + ⊕	182
CQ4 H	2 poles + ⊕	183
CQ4	3 poles + ⊕	184
CQ	5 poles + ⊕	186
CQ	7 poles + ⊕	187
CQ	12 poles + ⊕	189
CQ	21 poles + ⊕	190

## angled bulkhead mounting housings



**STAINLESS STEEL LEVER**

description	part No.
without cable entry, fixing by 4 screws	<b>CKAX 03 IA4</b>
gasket and screw kit for IP66/IP67/IP69 1)	<b>CKR 65</b>
gasket and screw kit for IP66/IP67/IP69 1) specific for CD 08 inserts	<b>CKR 65 D</b>

1) To obtain the IP66/IP67/IP69 degree of protection, a kit with insert fixing screw and gasket can be purchased separately.

Several inserts size "21.21" are already supplied with fixing screw and gasket, which ensures IP66/IP67/IP69 degree of protection. See list below, not including any special version:

- CQF/M 07, CQF/M 12
- CJ KF/M, CJF/M 4 /4/2 /8 /8/2
- CJK 8FT /8IFT /8MT /8IMT, CJK 8M
- CUK 2FT /3FT
- CX 1/2 BDF/M
- CLK 04 SCF /SCF-H /SCM
- CXL 2/4 PF /PM /PFH /PMH /SF /SM, CXL SF/M

**NOTE:** Housing type and colour may vary upon specific part No.

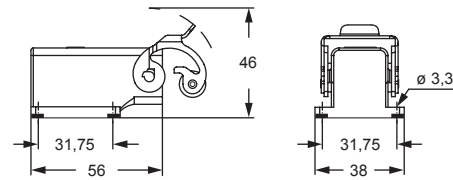
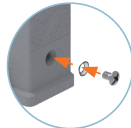

panel cut-out for enclosures

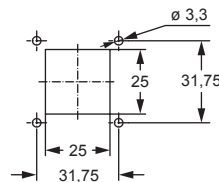

IP44/IP66/IP67/IP69 with CKR 65 (D) 1)

CKAX



# CKA - CKAXX standard metallic version

inserts		page:
CK	3 poles + ⊕	58
CK	4 poles + ⊕	58
CKS	3 poles + ⊕	-
CKS	4 poles + ⊕	-
CKSH	3 poles + ⊕	63
CKSH	4 poles + ⊕	63
CD	8 poles	67
CQ4	2 poles + ⊕	182
CQ4 H	2 poles + ⊕	183
CQ4	3 poles + ⊕	184
CQ	5 poles + ⊕	186
CQ	7 poles + ⊕	187
CQ	12 poles + ⊕	189
CQ	21 poles + ⊕	190

## angled bulkhead mounting housings



GALVANIZED STEEL RIGID LEVER

## angled bulkhead mounting housings

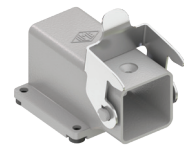

STAINLESS STEEL RIGID LEVER

description	part No.	part No.
without cable entry, fixing by 4 screws	<b>CKA 03 IA4</b>	
without cable entry, fixing by 4 screws		<b>CKAXX 03 IA4</b>
gasket and screw kit for IP66/IP67/IP69 <sup>1)</sup>	<b>CKR 65</b>	<b>CKR 65</b>
gasket and screw kit for IP66/IP67/IP69 <sup>1)</sup> specific for CD 08 inserts	<b>CKR 65 D</b>	<b>CKR 65 D</b>

1) To obtain the IP66/IP67/IP69 degree of protection, a kit with insert fixing screw and gasket can be purchased separately.  
 Several inserts size "21.21" are already supplied with fixing screw and gasket, which ensures IP66/IP67/IP69 degree of protection. See list below, not including any special version:

- CQF/M 07, CQF/M 12
- CJ KF/M, CJF/M 4 /4/2 /8 /8/2
- CJK 8FT /8IFT /8MT /8IMT, CJK 8M
- CUK 2FT /3FT
- CX 1/2 BDF/M
- CLK 04 SCF /SCF-H /SCM
- CXL 2/4 PF /PM /PFH /PMH /SF /SM, CXL SF/M

NOTE: Housing type and colour may vary upon specific part No.

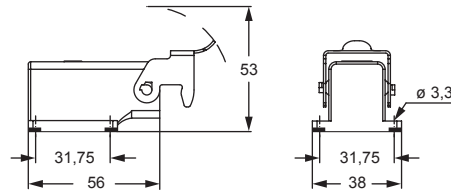
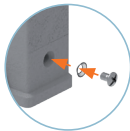

panel cut-out for enclosures

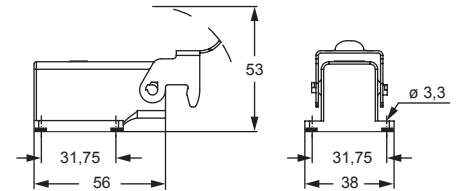
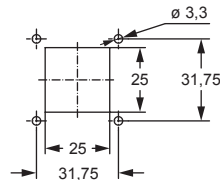

panel cut-out for enclosures

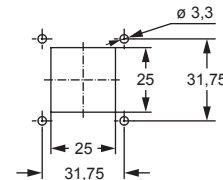

IP66/IP67/IP69 with CKR 65 (D) <sup>1)</sup>

# MKAX standard metallic version

inserts		page:
CK	3 poles + ⊕	58
CK	4 poles + ⊕	58
CKS	3 poles + ⊕	-
CKS	4 poles + ⊕	-
CKSH	3 poles + ⊕	63
CKSH	4 poles + ⊕	63
CD	8 poles	67
CQ4	2 poles + ⊕	182
CQ4 H	2 poles + ⊕	183
CQ4	3 poles + ⊕	184
CQ	5 poles + ⊕	186
CQ	7 poles + ⊕	187
CQ	12 poles + ⊕	189
CQ	21 poles + ⊕	190

## angled surface mounting housings



**STAINLESS STEEL LEVER**

## angled surface mounting housings

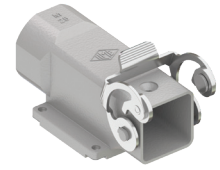

**STAINLESS STEEL LEVER**

description	part No. (entry - M25)	part No. (entry - M25)
with cable entry, fixing by 4 screws	<b>MKAX IAP25</b>	
with cable entry, fixing by 4 screws, bulkhead hole closed (without gasket)		<b>MKAX AP25</b>
gasket and screw kit for IP66/IP67/IP69 1)	<b>CKR 65</b>	<b>CKR 65</b>
gasket and screw kit for IP66/IP67/IP69 1) specific for CD 08 inserts	<b>CKR 65 D</b>	<b>CKR 65 D</b>

1) To obtain the IP66/IP67/IP69 degree of protection, a kit with insert fixing screw and gasket can be purchased separately. Several inserts size "21.21" are already supplied with fixing screw and gasket, which ensures IP66/IP67/IP69 degree of protection. See list below, not including any special version:

- CQF/M 07, CQF/M 12
- CJ KF/M, CJF/M 4 /4/2 /8 /8/2
- CJK 8FT /8IFT /8MT /8IMT, CJK 8M
- CUK 2FT /3FT
- CX 1/2 BDF/M
- CLK 04 SCF /SCF-H /SCM
- CXL 2/4 PF /PM /PFH /PMH /SF /SM, CXL SF/M

NOTE: Housing type and colour may vary upon specific part No.

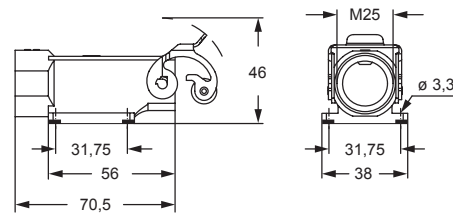
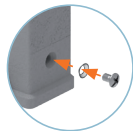

panel cut-out for enclosures

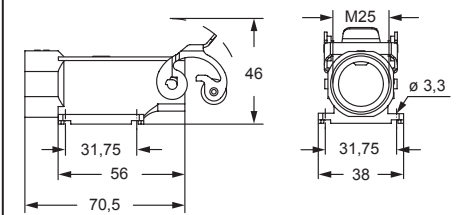
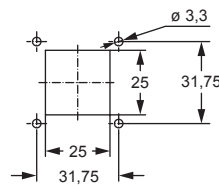

panel cut-out for enclosures

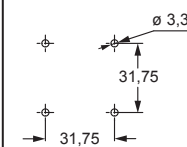

IP44 IP66/IP67/IP69 with CKR 65 (D) 1)

# MKA - MKAXX standard metallic version

inserts		page:
CK	3 poles + ⊕	58
CK	4 poles + ⊕	58
CKS	3 poles + ⊕	-
CKS	4 poles + ⊕	-
CKSH	3 poles + ⊕	63
CKSH	4 poles + ⊕	63
CD	8 poles	67
CQ4	2 poles + ⊕	182
CQ4 H	2 poles + ⊕	183
CQ4	3 poles + ⊕	184
CQ	5 poles + ⊕	186
CQ	7 poles + ⊕	187
CQ	12 poles + ⊕	189
CQ	21 poles + ⊕	190

## angled surface mounting housings

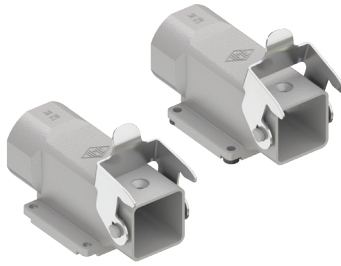

GALVANIZED STEEL RIGID LEVER

## angled surface mounting housings

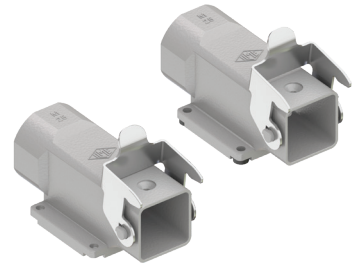

STAINLESS STEEL RIGID LEVER

description	part No. (entry - M25)	part No. (entry - M25)
with cable entry, fixing by 4 screws	<b>MKA IAP25</b>	<b>MKAXX IAP25</b>
with cable entry, fixing by 4 screws, bulkhead hole closed (without gasket)	<b>MKA AP25</b>	<b>MKAXX AP25</b>
with cable entry, fixing by 4 screws	<b>MKAXX IAP25</b>	<b>MKAXX IAP25</b>
with cable entry, fixing by 4 screws, bulkhead hole closed (without gasket)	<b>MKAXX AP25</b>	<b>MKAXX AP25</b>
gasket and screw kit for IP66/IP67/IP69 1)	<b>CKR 65</b>	<b>CKR 65</b>
gasket and screw kit for IP66/IP67/IP69 1) specific for CD 08 inserts	<b>CKR 65 D</b>	<b>CKR 65 D</b>

1) To obtain the IP66/IP67/IP69 degree of protection, a kit with insert fixing screw and gasket can be purchased separately.  
Several inserts size "21.21" are already supplied with fixing screw and gasket, which ensures IP66/IP67/IP69 degree of protection. See list below, not including any special version:

- CQF/M 07, CQF/M 12
- CJ KF/M, CJF/M 4 /4/2 /8 /8/2
- CJK 8FT /8IFT /8MT /8IMT, CJK 8M
- CUK 2FT /3FT
- CX 1/2 BDF/M
- CLK 04 SCF /SCF-H /SCM
- CXL 2/4 PF /PM /PFH /PMH /SF /SM, CXL SF/M

NOTE: Housing type and colour may vary upon specific part No.

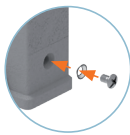

### MKA IAP

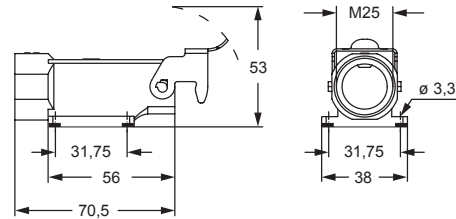

panel cut-out for enclosures

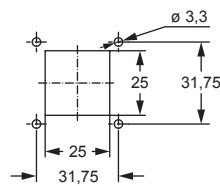

### MKA AP

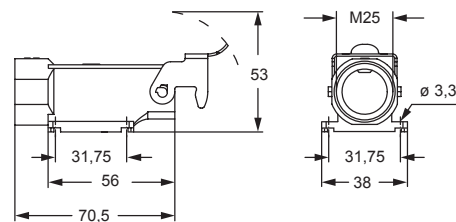

panel cut-out for enclosures

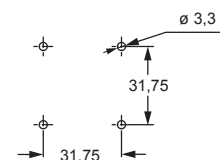

### MKAXX IAP

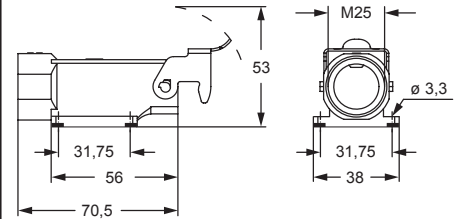

panel cut-out for enclosures

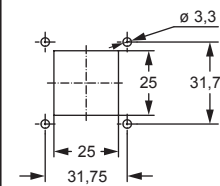

### MKAXX AP

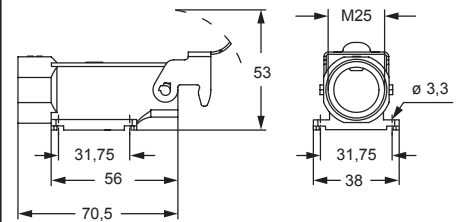

panel cut-out for enclosures

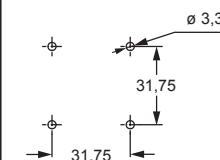

IP66/IP67/IP69 with CKR 65 (D) 1)

# MKAX standard metallic version

inserts		page:
CK	3 and 4 poles + ⊕	58
CKS	3 and 4 poles + ⊕	-
CKSH	3 and 4 poles + ⊕	63
CD	8 poles	67
CQ4	2 poles + ⊕	182
CQ4 H	2 poles + ⊕	183
CQ4	3 poles + ⊕	184
CQ	5 poles + ⊕	186
CQ	7 poles + ⊕	187
CQ	12 poles + ⊕	189
CQ	21 poles + ⊕	190
CJ KM		305
CJK 8MT		308
CJK 8IMT		308
CLK 04 SC		321
CX 1/2 BD		325
CXL 2/4 SF/SM		332
CXL SF/SM		332
CXL 2/4 PF/PM		333
CXL 2/4 PFH/PMH		333
CXL PF/PM		333

## hoods

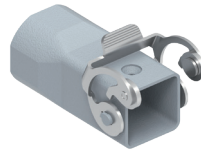



 **STAINLESS STEEL LEVER**

description	part No. (entry - M25)
top entry	<b>MKAX VG25</b>
gasket and screw kit for IP66/IP67/IP69 1)	<b>CKR 65</b>
gasket and screw kit for IP66/IP67/IP69 1) specific for CD 08 inserts	<b>CKR 65 D</b>

1) To obtain the IP66/IP67/IP69 degree of protection, a kit with insert fixing screw and gasket can be purchased separately.  
Several inserts size "21.21" are already supplied with fixing screw and gasket, which ensures IP66/IP67/IP69 degree of protection. See list below, not including any special version:

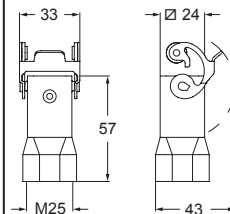
- CQF/M 07, CQF/M 12
- CJ KF/M, CJF/M 4 /4/2 /8 /8/2
- CJK 8FT /8IFT /8MT /8IMT, CJK 8M
- CUK 2FT /3FT
- CX 1/2 BDF/M
- CLK 04 SCF /SCF-H /SCM
- CXL 2/4 PF /PM /PFH /PMH /SF /SM, CXL SF/M



 **NOTE:** Housing type and colour may vary upon specific part No.

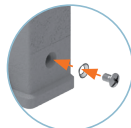

cURus  
Type 12 / Type 4/4X only with CKR 65 (D) pending



IP44 IP66/IP67/IP69 with CKR 65 (D) 1)

# MKA - MKAXX standard metallic version

inserts		page:
CK	3 and 4 poles + ⊕	58
CKS	3 and 4 poles + ⊕	-
CKSH	3 and 4 poles + ⊕	63
CD	8 poles	67
CQ4	2 poles + ⊕	182
CQ4 H	2 poles + ⊕	183
CQ4	3 poles + ⊕	184
CQ	5 poles + ⊕	186
CQ	7 poles + ⊕	187
CQ	12 poles + ⊕	189
CQ	21 poles + ⊕	190
CJ KM		305
CJK 8MT		308
CJK 8IMT		308
CLK 04 SC		321
CX 1/2 BD		325
CXL 2/4 SF/SM		332
CXL SF/SM		332
CXL 2/4 PF/PM		333
CXL 2/4 PFH/PMH		333
CXL PF/PM		333

hoods

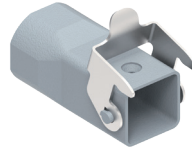

GALVANIZED STEEL RIGID LEVER

hoods

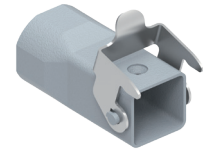

STAINLESS STEEL RIGID LEVER

description	part No. (entry - M25)	part No. (entry - M25)
top entry	<b>MKA VG25</b>	
top entry		<b>MKAXX VG25</b>
gasket and screw kit for IP66/IP67/IP69 1)	<b>CKR 65</b>	<b>CKR 65</b>
gasket and screw kit for IP66/IP67/IP69 1) specific for CD 08 inserts	<b>CKR 65 D</b>	<b>CKR 65 D</b>

1) To obtain the IP66/IP67/IP69 degree of protection, a kit with insert fixing screw and gasket can be purchased separately.  
Several inserts size "21.21" are already supplied with fixing screw and gasket, which ensures IP66/IP67/IP69 degree of protection. See list below, not including any special version:

- CQF/M 07, CQF/M 12
- CJ KF/M, CJF/M 4 /4/2 /8 /8/2
- CJK 8FT /8IFT /8MT /8IMT, CJK 8M
- CUK 2FT /3FT
- CX 1/2 BDF/M
- CLK 04 SCF /SCF-H /SCM
- CXL 2/4 PF /PM /PFH /PMH /SF /SM, CXL SF/M

NOTE: Housing type and colour may vary upon specific part No.

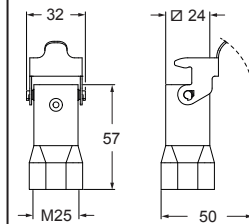
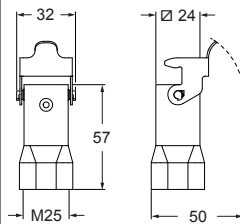
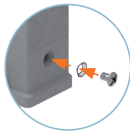

cURus  
Type 12 / Type 4/4X only with CKR 65 (D) pending



IP66/IP67/IP69 with CKR 65 (D) 1)

# MKAX standard metallic version

inserts		page:
CK	3 and 4 poles + ⊕	58
CKS	3 and 4 poles + ⊕	-
CKSH	3 and 4 poles + ⊕	63
CD	8 poles	67
CQ4	2 poles + ⊕	182
CQ4 H	2 poles + ⊕	183
CQ4	3 poles + ⊕	184
CQ	5 poles + ⊕	186
CQ	7 poles + ⊕	187
CQ	12 poles + ⊕	189
CQ	21 poles + ⊕	190
CJ KF		305
CJK 8FT		308
CLK 04 SC		321
CX 1/2 BD		325
CXL 2/4 SF/SM		332
CXL SF/SM		332
CXL 2/4 PF/PM		333
CXL 2/4 PFH/PMH		333
CXL PF/PM		333

## bulkhead mounting housings



### STAINLESS STEEL LEVER

description	part No. (entry - M32)
M32 fixing thread <sup>1) (1)</sup>	<b>MKAX IF</b>
gasket and screw kit for IP66/IP67/IP69 <sup>1)</sup>	<b>CKR 65</b>
gasket and screw kit for IP66/IP67/IP69 <sup>1)</sup> specific for CD 08 inserts	<b>CKR 65 D</b>

1) To obtain the IP66/IP67/IP69 degree of protection, a kit with insert fixing screw and gasket can be purchased separately. Several inserts size "21.21" are already supplied with fixing screw and gasket, which ensures IP66/IP67/IP69 degree of protection. See list below, not including any special version:

- CQF/M 07, CQF/M 12
- CJ KF/M, CJF/M 4 /4/2 /8 /8/2
- CJK 8FT /8IFT /8MT /8IMT, CJK 8M
- CUK 2FT /3FT
- CX 1/2 BDF/M
- CLK 04 SCF /SCF-H /SCM
- CXL 2/4 PF /PM /PFH /PMH /SF /SM, CXL SF/M.

 NOTE: Housing type and colour may vary upon specific part No.

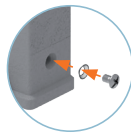

<sup>(1)</sup> Locknut supplied on request, see Cable glands catalogue (article AS M32N metallic).

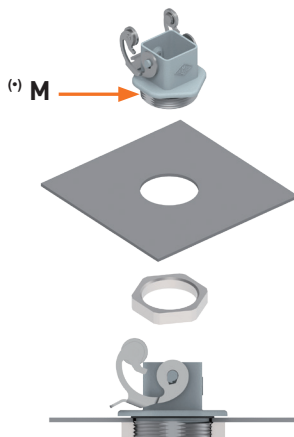

 NOTE: Lever type and housing colour may vary upon specific part No.

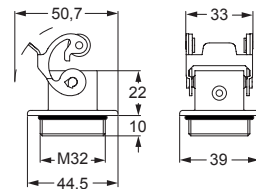

panel cut-out for enclosures

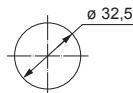

cURus  
Type 4/4X/12 pending



IP66/IP67/IP69 with CKR 65 (D) <sup>1)</sup>



# MKA - MKAXX standard metallic version

inserts		page:
CK	3 and 4 poles + ⊕	58
CKS	3 and 4 poles + ⊕	-
CKSH	3 and 4 poles + ⊕	63
CD	8 poles	67
CQ4	2 poles + ⊕	182
CQ4 H	2 poles + ⊕	183
CQ4	3 poles + ⊕	184
CQ	5 poles + ⊕	186
CQ	7 poles + ⊕	187
CQ	12 poles + ⊕	189
CQ	21 poles + ⊕	190
CJ KF		305
CJK 8FT		308
CLK 04 SC		321
CX 1/2 BD		325
CXL 2/4 SF/SM		332
CXL SF/SM		332
CXL 2/4 PF/PM		333
CXL 2/4 PFH/PMH		333
CXL PF/PM		333

## bulkhead mounting housings



GALVANIZED STEEL RIGID LEVER

## bulkhead mounting housings



STAINLESS STEEL RIGID LEVER

description	part No. (entry - M32)	part No. (entry - M32)
M32 fixing thread <sup>1)</sup> (*)	<b>MKA IF</b>	
M32 fixing thread <sup>1)</sup> (*)		<b>MKAXX IF</b>
gasket and screw kit for IP66/IP67/IP69 <sup>1)</sup>	<b>CKR 65</b>	<b>CKR 65</b>
gasket and screw kit for IP66/IP67/IP69 <sup>1)</sup> specific for CD 08 inserts	<b>CKR 65 D</b>	<b>CKR 65 D</b>

<sup>1)</sup> To obtain the IP66/IP67/IP69 degree of protection, a kit with insert fixing screw and gasket can be purchased separately.  
Several inserts size "21.21" are already supplied with fixing screw and gasket, which ensures IP66/IP67/IP69 degree of protection. See list below, not including any special version:

- CQF/M 07, CQF/M 12
- CJ KF/M, CJF/M 4 /4/2 /8 /8/2
- CJK 8FT /8IFT /8MT /8IMT, CJK 8M
- CUK 2FT /3FT
- CX 1/2 BDF/M
- CLK 04 SCF /SCF-H /SCM
- CXL 2/4 PF /PM /PFH /PMH /SF /SM, CXL SF/M.

NOTE: Housing type and colour may vary upon specific part No.

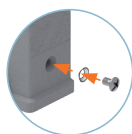

<sup>1)</sup> Locknut supplied on request, see Cable glands catalogue (article AS M32N metallic).

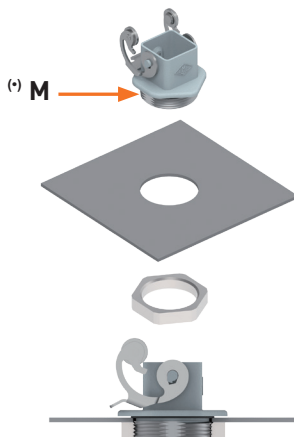

NOTE: Lever type and housing colour may vary upon specific part No.

cURus  
Type 4/4X/12 pending



IP44 IP66/IP67/IP69 with CKR 65 (D) <sup>1)</sup>

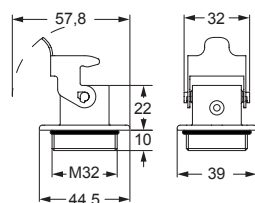

panel cut-out for enclosures

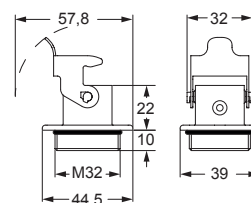
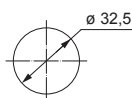

panel cut-out for enclosures

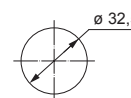

## Thermoplastic enclosures size “32.13” standard or EMC versions

### SUM-UP

🔒 For use with all size “32.13” connector inserts.

#### 🔍 Characteristics of materials

##### for CQ - MQ series

- In self-extinguishing grey RAL 7035 or black thermoplastic material;
- gaskets in anti-aging, oil-resistant, grease-resistant and fuel-resistant NBR vinyl nitrile elastomer;
- with single-block locking lever in self-extinguishing thermoplastic material.

✓ UL certified for USA and Canada for Type 4, 4X and 12 degrees of protection (enclosure type ratings, equivalent to NEMA rating), printed on the packaging.

IP66/IP67/IP69 degree of protection.



# CQ insulating version

inserts		page:
CQ 04/2	4 poles + 2 poles + ⊕	191
CQ 08	8 poles + ⊕	192
CQ 17	17 poles + ⊕	193

## bulkhead mounting housings with single lever



## angled bulkhead mounting housings with single lever



description	part No.	part No.	entry - Pg
with lever	<b>CQ 08 I</b>		
without cable entry, with lever		<b>CQ 08 IA</b>	
with cable entry, with lever		<b>CQ 08 IAP</b>	21

### CQ I

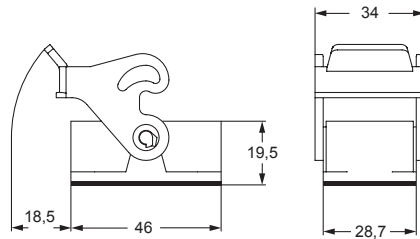

panel cut-out for CQ I enclosure

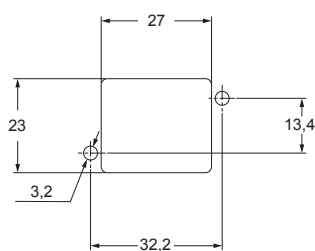

### CQ IA

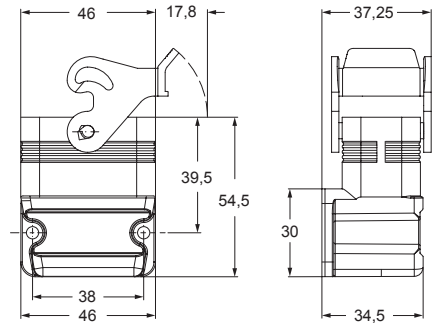

### CQ IAP

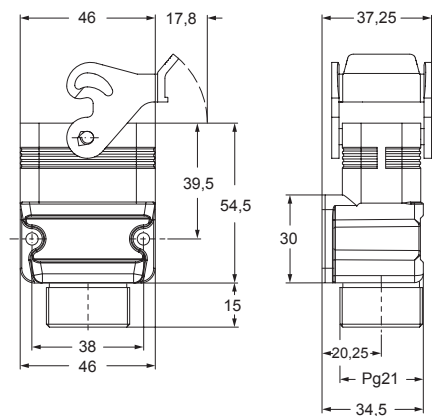

panel cut-out for CQ IA - CQ IAP enclosure

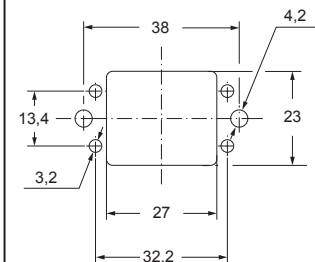

**CALUS** Type 4/4X/12



# CQ insulating version

inserts

CQ 04/2	4 poles + 2 poles + ⊕
CQ 08	8 poles + ⊕
CQ 17	17 poles + ⊕

page:

191
192
193

hoods with 2 pegs



hoods with 2 pegs



description	part No.	entry - Pg	part No.	entry - M
with pegs, side entry *	<b>CQ 08 VA</b>	16		
with pegs, top entry *	<b>CQ 08 V</b>	21		
with pegs, side and top entry 1)			<b>MQ 08 VO225</b>	25 x 2

\* Pg male thread on enclosure exterior

- 1) metric thread on the internal enclosure;  
 accessories to be ordered separately:  
 - **AL M25DN** insulating black sealing plug M 25  
 - **AL M25IN** insulating black cable gland M 25

**CQ VA**

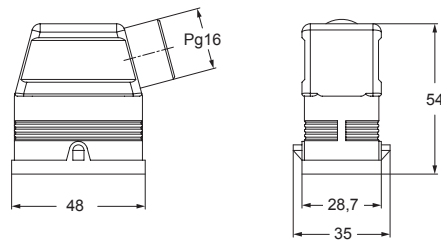

**MQ VO**

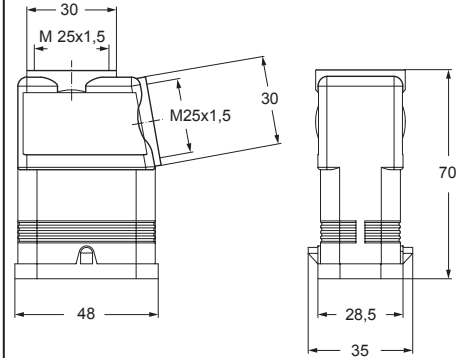

**CQ V**

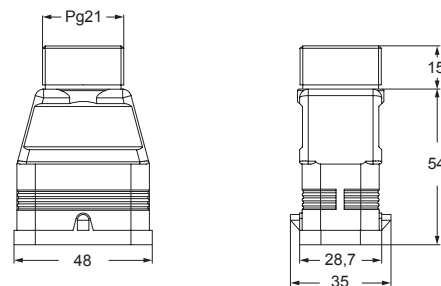

**CAVUS**® Type 4/4X/12  
 (pending for MQ 08 VO225)



# CQ insulating version

inserts		page:
CQ 04/2	4 poles + 2 poles + ⊕	191
CQ 08	8 poles + ⊕	192
CQ 17	17 poles + ⊕	193

## hoods with single lever



## covers with 2 pegs thermoplastic resin cable glands



description	part No.	entry - Pg	part No.
with lever, top entry *	<b>CQ 08 VG</b>	21	
cover with 2 pegs for female inserts			<b>CQ 08 C</b>
cover with 2 pegs for male inserts			<b>CQ 08 CA</b>
cable gland head and gasket for CQ 08 VA enclosure			<b>CRQ 16</b>
cable gland head and gasket for CQ 08 V and VG enclosure			<b>CRQ 21</b>

\* Pg male thread on enclosure exterior

cable diameters for cable glands:  
 - **CRQ 16**: 10 - 14,5 mm  
 - **CRQ 21**: 14 - 18 mm

### CQ VG

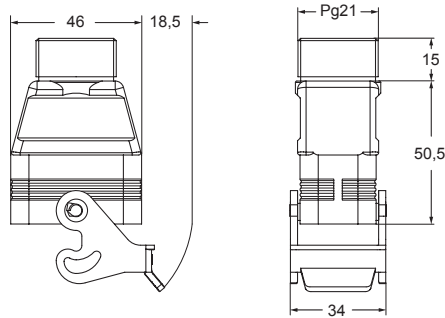

### CQ C and CQ CA

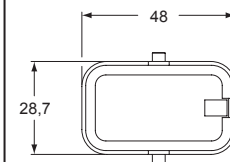

### CRQ 16 and CRQ 21

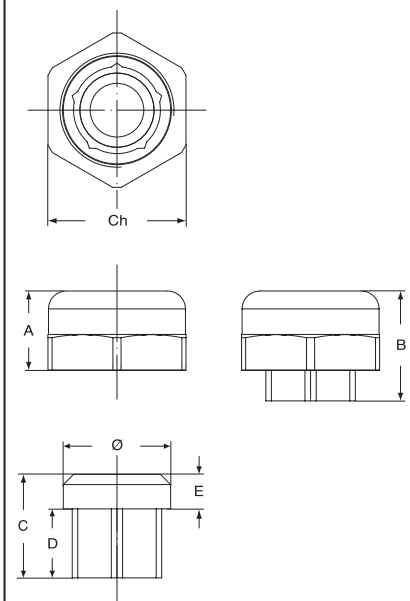

part No.	A	B	C	D	E	Ø	Ch
<b>CRQ 16</b>	15,5	21,5	20,25	13,5	6,75	21	27
<b>CRQ 21</b>	18,2	27,5	25	15,5	9	26,5	33

**CRUS** Type 4/4X/12



## MIXO ONE - CXA - MXA TECHNICAL FEATURES

MIXO ONE is the aluminium housings system designed by ILME to accept the wide range of MIXO series single-sized modules.

- These robust connector enclosures (3 hood variants and 1 bulkhead mounting housing) transform each single MIXO module into a completely independent connector;
- the enclosures allow mounting of single MIXO module only in one guided way, to avoid incorrect match with the mating connector;
- the enclosures incorporate a pre-leading (first-make, last-break) PE connection terminal and contact, for the safest connector operation;
- the pins protruding from the bulkhead mounting housing act also as key guide, in cooperation with the corresponding keyway sockets in the hoods, to avoid incorrect 180° reversed mating with corresponding connector;
- the rigid locking lever is releasably mounted on moulded pegs that include a stopping teeth;
- the hoods are split in two parts (front, rear), to allow MIXO module mounting and simplify the enclosure's PE connection. Supplied with four self-threading screws and self-retaining sealing gasket;
- the bulkhead mounting housing is supplied with the module locking frame and self-retaining flange gasket;
- four optional coding pins available for up to 16 different codings, as a provision against mismatching when identical connectors are installed side by side;
- protection covers for hoods and housings, either with pegs (for enclosures with locking lever and sealing gasket) or with locking lever and sealing gasket (for enclosures with pegs) available either with eyelet-terminated string (for fastening to housings) or with loop-terminated cord (for fastening to hoods, around the incoming cable).

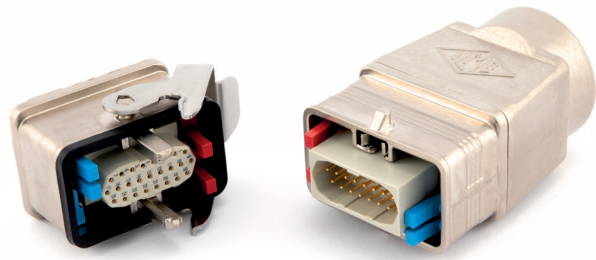

### SUM-UP

- ☑ Aluminium die cast alloy, nickel plated;
- ☑ rigid stainless steel locking lever;
- ☑ hoods split in two parts (front, rear), to simplify the PE connection. Supplied with four self-threading screws and sealing gasket;
- ☑ four optional coding pins for up to 16 different codings, as a provision against mismatching when identical connectors are installed side by side;
- ☑ protection covers for hoods and housings made in shock-proof thermoplastic material, either with pegs (for enclosures with locking lever and sealing gasket) or with locking lever and sealing gasket (for enclosures with pegs) both with eyelet-terminated string (for fastening to housings) or with loop-terminated cord (for fastening to hoods, around the incoming cable).



Watch  
our  
video



**bulkhead mounting housing with single lever**

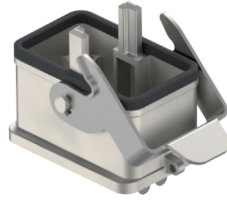

**AVAILABLE SEPTEMBER 2019**

**hoods with 2 pegs**



**AVAILABLE SEPTEMBER 2019**

description	part No.	part No.	entry M
with lever	<b>CXA 01 I</b>		
with pegs, side entry (in 2 parts)		<b>MXA 01 O25</b>	25
with pegs, top entry (in 2 parts)		<b>MXA 01 V25</b>	25
with pegs, top entry (in 2 parts)		<b>MXA 01 V32</b>	32

**CXA I**

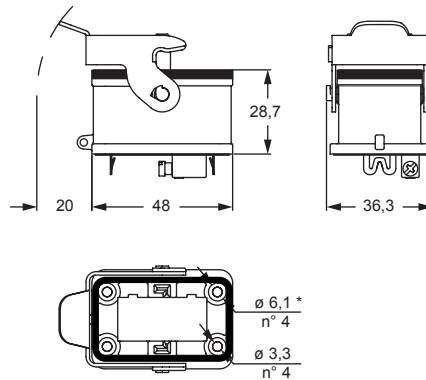

\* for M3 fixing screws (not supplied) with maximum 6 mm head diameter

panel cut-out for bulkhead mounting housings

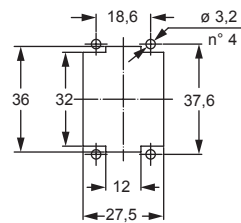

**MXA 025**

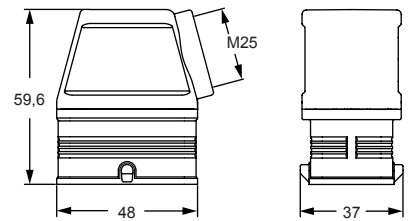

**MXA V25**

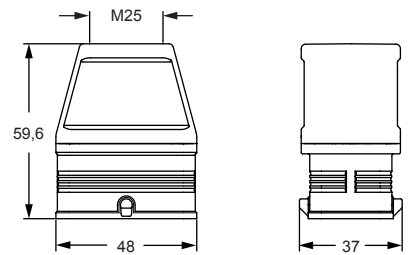

**MXA V32**

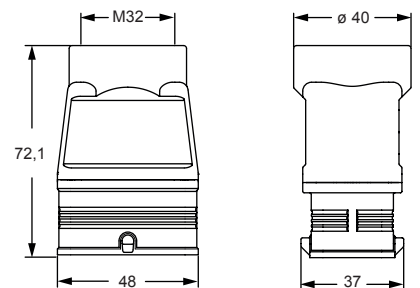

cURus  
Type 4/4X/12 pending



according to IEC/EN 60529

plastic covers

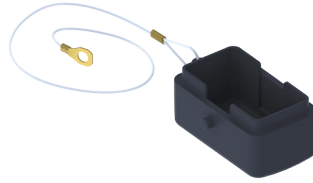

AVAILABLE SEPTEMBER 2019

plastic covers with lever and gasket

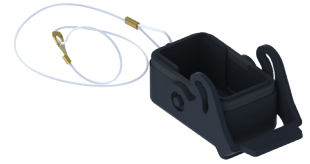

AVAILABLE SEPTEMBER 2019

description

part No.  
(with eyelet)

part No.  
(with loop)

with 2 pegs (for enclosures with 1 lever with gasket)

**CXP 01 C**

with 1 lever and gasket (for hoods with 2 pegs)

**CXP 01 CLG**

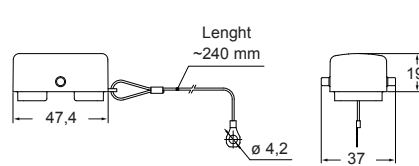

For fixing on housings

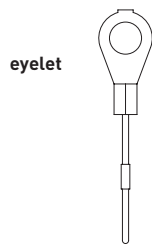

eyelet

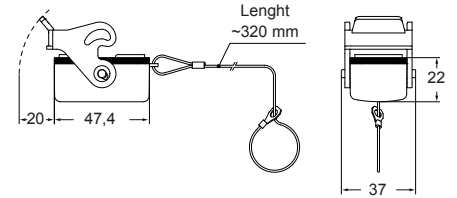

For fixing on hoods

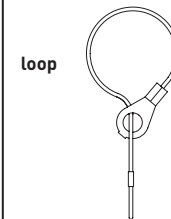

loop

cURus  
Type 4/4X/12 pending



according to IEC/EN 60529

# MIXO ONE CR CX coding pins

coding pins

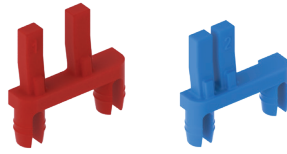

AVAILABLE SEPTEMBER 2019

coding pins



AVAILABLE SEPTEMBER 2019

description	part No.	part No.
red coding pin (#1)	CR CX01R	
blue coding pin (#2)	CR CX01B	
yellow coding pin (#3)		CR CX01G
black coding pin (#4)		CR CX01N

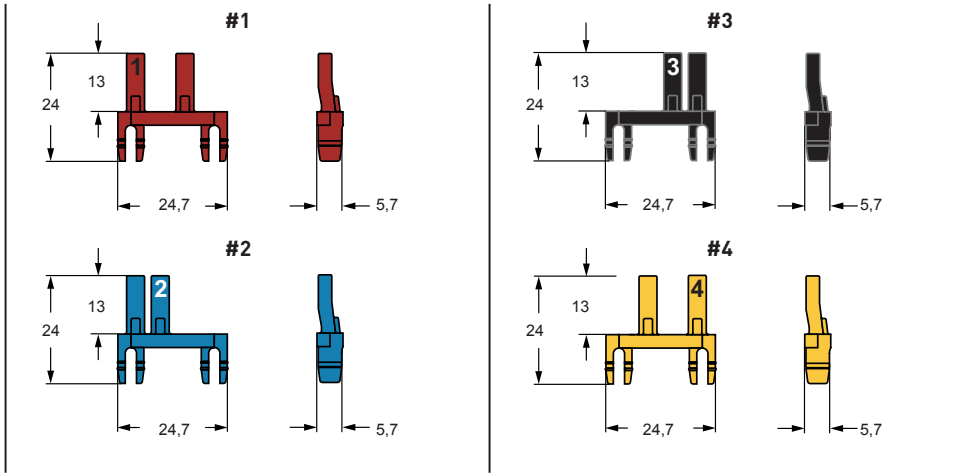

## CR CX01 CODING OPTIONS

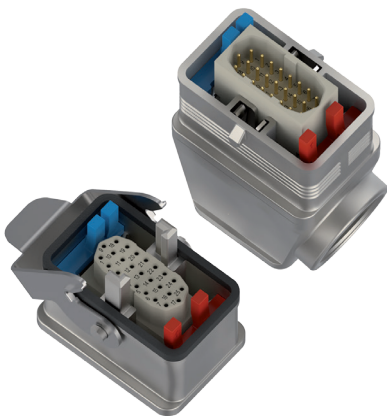

Example of coding option 6 of 16 different codings possible (4 coding pins per each connector coupling)





# IL-BRID

## Soft closing, strong hold

Through its original design, the IL-BRID locking lever combines the smoothness of the thermoplastic material with the sturdiness of the stainless steel spring; it has also a linear design which favours a quick wash without retaining external elements.



### SUM-UP

- ☐ **Soft closing:** in the first phase, the thermoplastic locking lever component comes into play: sliding the new locking lever on the pin reduces friction and wear. It is suitable in all applications with frequent opening and closing.
- ☐ **Strong hold:** after the first closing phase involving the plastic component, the stainless steel hook intervenes to guarantee higher resistance to mechanical stress.

✔ IP66/IP69 degree of protection.

### ✍ Characteristics of materials for CZ and MZ series

- Made of die cast aluminium alloy;
- with epoxy-polyester powder coating;
- gaskets in anti-aging, oil-resistant, grease-resistant and fuel-resistant vinyl nitrile elastomer;
- locking device with levers and springs in stainless steel;
- lever handles in self-extinguishing thermoplastic material reinforced with glass fibres, UL approved (for CZ and MZ enclosures)

# CZ - MZ IL-BRID standard version

**inserts**

CD	15 poles + ⊕
CDA	10 poles + ⊕
CSAH	10 poles + ⊕
CDC	10 poles + ⊕
MIXO	1 module

**page:**

68
98
99
104
234 - 286

**bulkhead mounting housings with single lever**



**surface mounting housings with single lever**

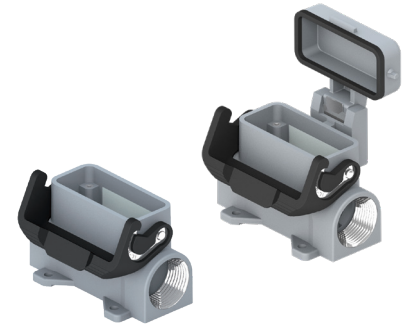

description	part No.	part No.	entry Pg	part No.	entry M
with single lever	<b>CZI 15 L</b>				
with single lever and cover	<b>CZI 15 LS</b>				
with single lever		<b>CZP 15 L</b>	16		
with single lever		<b>CZP 15 L2</b>	16 x 2		
with single lever		<b>CZP 15 L21</b>	21	<b>MZP 15 L25</b>	25
with single lever		<b>CZP 15 L221</b>	21 x 2	<b>MZP 15 L225</b>	25 x 2
with single lever and cover		<b>CZP 15 LS</b>	16		
with single lever and cover		<b>CZP 15 LS2</b>	16 x 2		
with single lever and cover		<b>CZP 15 LS21</b>	21	<b>MZP 15 LS25</b>	25
with single lever and cover		<b>CZP 15 LS221</b>	21 x 2	<b>MZP 15 LS225</b>	25 x 2

panel cut-out for bulkhead mounting housings

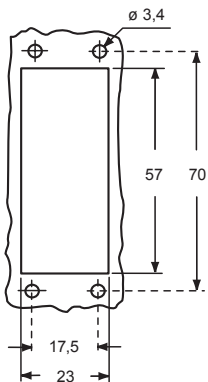

The enclosures ensure IP66 degree of protection (or IP65 for hinged cover versions) rating when mated and locked with the closing levers.

**CZI L**

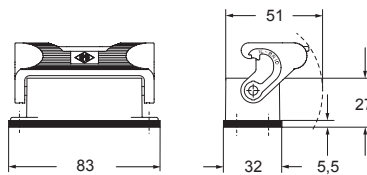

**CZI LS**

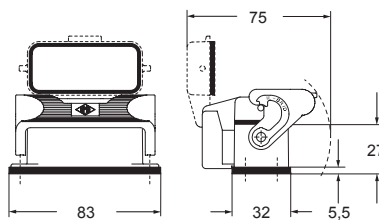

**CZP L and MZP L**

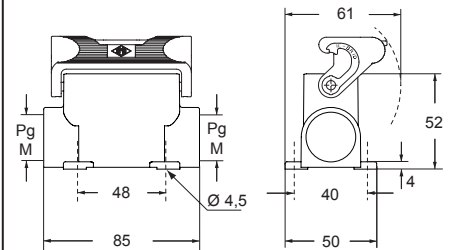

**CZP LS and MZP LS**

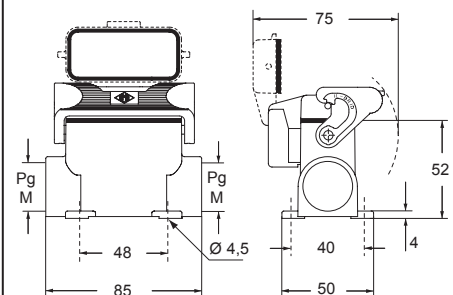

**CAIUS**® Type 4/4X/12





# CZ - MZ IL-BRID lever standard version SIMPLEX self-closing covers

<b>inserts</b>		<b>page:</b>
CD	15 poles + ⊕	<b>68</b>
CDA	10 poles + ⊕	<b>98</b>
CSAH	10 poles + ⊕	<b>99</b>
CDC	10 poles + ⊕	<b>104</b>
MIXO	1 module	<b>234 - 286</b>

## bulkhead mounting housings with single lever



## surface mounting housings with single lever



description	part No.	part No.	entry Pg	part No.	entry M
with single lever and cover	<b>CZI 15 LSP</b>				
with lever and cover		<b>CZP 15 LSP16</b>	16	<b>MZP 15 LSP20</b>	20
with lever and cover		<b>CZP 15 LSP21</b>	21	<b>MZP 15 LSP25</b>	25

### panel cut-out for bulkhead mounting housings

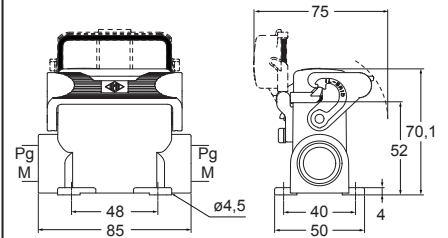
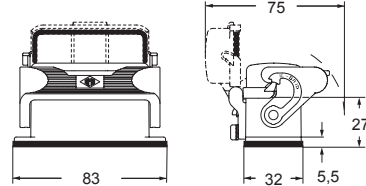
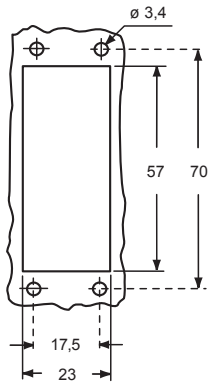

The enclosures ensure IP65 degree of protection when mated and locked with the closing lever.

**CAIUS**® Type 4/4X/12



cURus Type 12 / Type 4/4X pending



# CZ - CZA - CZF and MZ - MZA - MZF IL-BRID standard version

inserts

CD	15 poles + ⊕
CDA	10 poles + ⊕
CSAH	10 poles + ⊕
CDC	10 poles + ⊕
MIXO	1 module

page:

68
98
99
104
232 - 287

hoods with 2 pegs

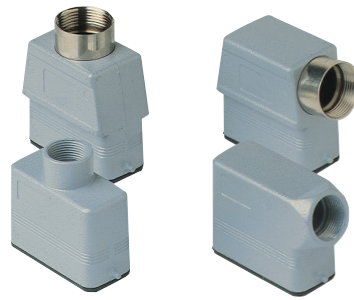

hoods with single lever



description	part No.	entry Pg	part No.	entry M	part No.	entry Pg	part No.	entry M
with pegs, side entry	<b>CZO 15 L</b>	16	<b>MZO 15 L20</b>	20				
with pegs, side entry			<b>MZO 15 L25</b>	25				
with pegs, side entry, high construction	<b>CZAO 15 L16</b>	16	<b>MZAO 15 L20</b>	20				
with pegs, side entry, high construction	<b>CZAO 15 L21</b>	21	<b>MZAO 15 L25</b>	25				
with pegs, top entry	<b>CZV 15 L</b>	13,5	<b>MZV 15 L20</b>	20				
with pegs, top entry, high construction	<b>CZAV 15 L16</b>	16	<b>MZAV 15 L20</b>	20				
with pegs, top entry, high construction	<b>CZAV 15 L21</b>	21	<b>MZAV 15 L25</b>	25				
with pegs, side entry, high construction, without adaptor *	<b>CZFO 15 L16</b>	16	<b>MZFO 15 L20</b>	20				
with pegs, side entry, high construction, without adaptor *	<b>CZFO 15 L21</b>	21	<b>MZFO 15 L25</b>	25				
with pegs, top entry, high construction, without adaptor *	<b>CZFV 15 L16</b>	16	<b>MZFV 15 L20</b>	20				
with pegs, top entry, high construction, without adaptor *	<b>CZFV 15 L21</b>	21	<b>MZFV 15 L25</b>	25				
with single lever, top entry			<b>CZV 15 LG</b>	13,5			<b>MZV 15 LG20</b>	20

\* enclosure without adaptor, threaded on the body, to be used only with a complete cable gland.

**CZO L and MZO L**

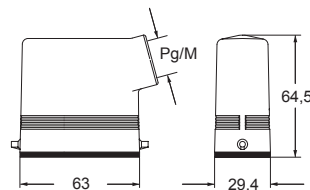

**CZAO L - MZAO L and CZAV L - MZAV L**

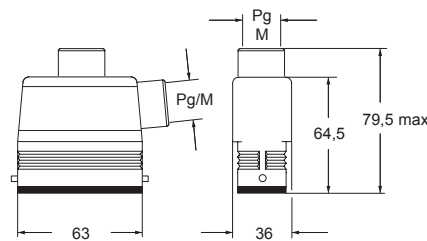

**CZV L and MZV L**

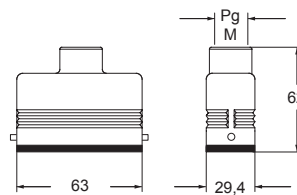

**CZFO L - MZFO L and CZFV L - MZFV L**

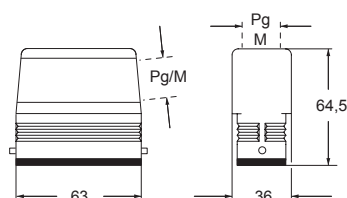

**CZV LG and MZV LG**

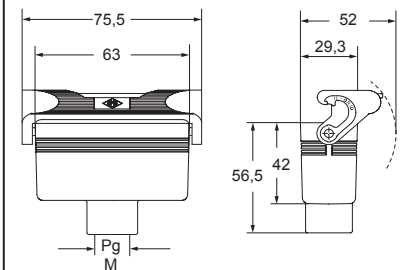

IL-BRID

**CAUS**® Type 4/4X/12



IP66 if hoods with fused pegs and without adapters coupled with IP67 housings

# CZ IL-BRID standard version

inserts		page:
CD	15 poles + ⊕	68
CDA	10 poles + ⊕	98
CSAH	10 poles + ⊕	99
CDC	10 poles + ⊕	104
MIXO	1 module	232 - 287

## covers



description	part No. (with eyelet)	part No. (with loop)
with pegs and gasket (for 1 lever enclosures)	<b>CZC 15 L</b>	<b>CZC 15 SL</b>
with lever (for enclosures with pegs)		<b>CZC 15 LG</b>

Cover versions L and LG cannot be used together with coding pins.  
If this application is required, please contact ILME S.p.A.

### CZC L (SL)

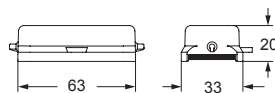

### CZC LG

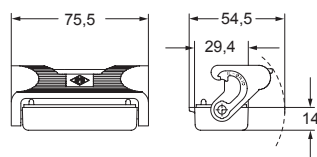

### For fixing on housings

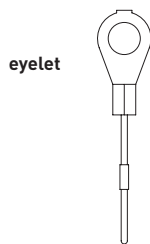

### For fixing on hoods

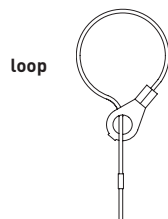

**CAIUS**® Type 4/4X/12



**CZ - CZA and MZA IL-BRID standard version**

inserts

CD	25 poles + ⊕
CDD	38 poles + ⊕
CDA	16 poles + ⊕
CSAH	16 poles + ⊕
CDC	16 poles + ⊕

page:

69
77
100
101
105

**bulkhead mounting housings with single lever**

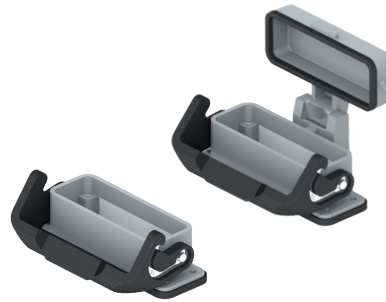

**surface mounting housings with single lever**



description	part No.	part No.	entry Pg	part No.	entry M
with single lever	<b>CZI 25 L</b>				
with single lever and cover	<b>CZI 25 LS</b>				
with single lever, high construction		<b>CZAP 25 L</b>	16		
with single lever, high construction		<b>CZAP 25 L2</b>	16 x 2		
with single lever, high construction		<b>CZAP 25 L21</b>	21	<b>MZAP 25 L25</b>	25
with single lever, high construction		<b>CZAP 25 L221</b>	21 x 2	<b>MZAP 25 L225</b>	25 x 2
with single lever and cover, high construction		<b>CZAP 25 LS</b>	16		
with single lever and cover, high construction		<b>CZAP 25 LS2</b>	16 x 2		
with single lever and cover, high construction		<b>CZAP 25 LS21</b>	21	<b>MZAP 25 LS25</b>	25
with single lever and cover, high construction		<b>CZAP 25LS221</b>	21 x 2	<b>MZAP 25LS225</b>	25 x 2

panel cut-out for bulkhead mounting housings

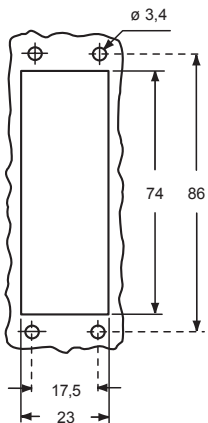

**CZI L**

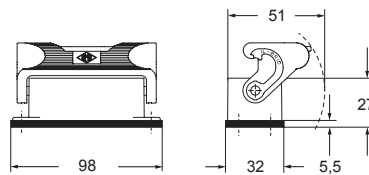

**CZI LS**

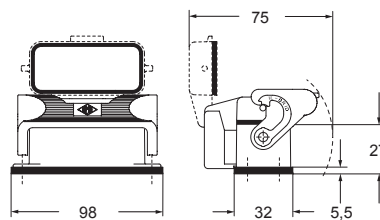

**CZAP L and MZAP L**

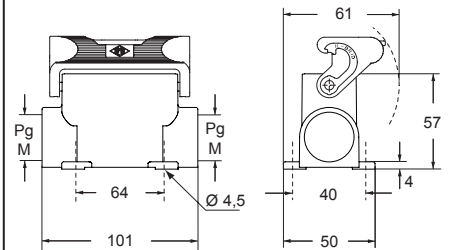

**CZAP LS and MZAP LS**

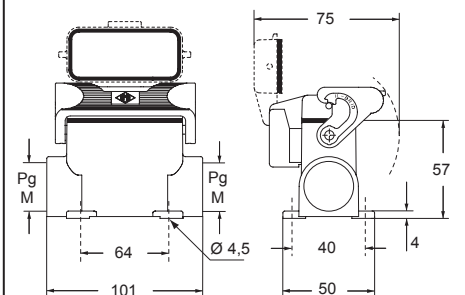

The enclosures ensure IP66 degree of protection (or IP65 for hinged cover versions) rating when mated and locked with the closing levers.

**CAIUS** Type 4/4X/12



IL-BRID

**CZ - CZA and MZA IL-BRID lever standard version SIMPLEX self-closing covers**

<b>inserts</b>		<b>page:</b>
CD	25 poles + ⊕	<b>69</b>
CDD	38 poles + ⊕	<b>77</b>
CDA	16 poles + ⊕	<b>100</b>
CSAH	16 poles + ⊕	<b>101</b>
CDC	16 poles + ⊕	<b>105</b>

**bulkhead mounting housings with single lever**



**surface mounting housings with single lever**



description	part No.	part No.	entry Pg	part No.	entry M
with single lever and cover	<b>CZI 25 LSP</b>				
with lever and cover, high construction		<b>CZAP 25LSP16</b>	16	<b>MZAP 25LSP20</b>	20
with lever and cover, high construction		<b>CZAP 25LSP21</b>	21	<b>MZAP 25LSP25</b>	25

panel cut-out for bulkhead mounting housings

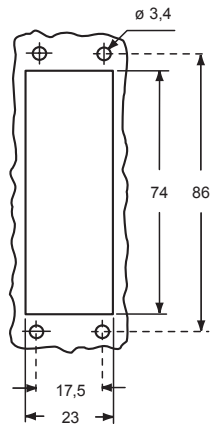

The enclosures ensure IP65 degree of protection when mated and locked with the closing lever.

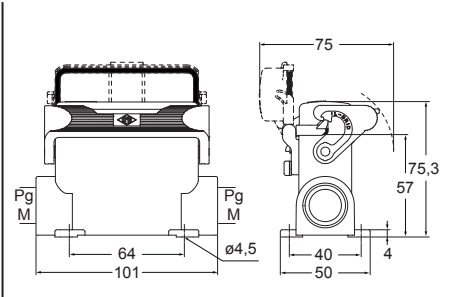
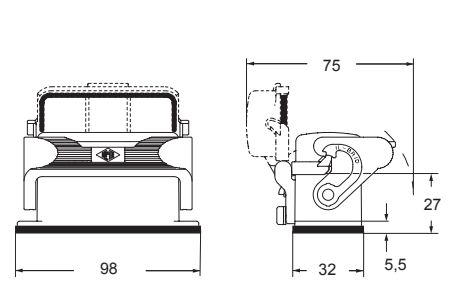

**CRUIS** Type 4/4X/12



cURus Type 12 / Type 4/4X pending



**IL-BRID**

**CZ - CZA - CZF and MZ - MZA - MZF IL-BRID standard version**

inserts

CD	25 poles + ⊕
CDD	38 poles + ⊕
CDA	16 poles + ⊕
CSAH	16 poles + ⊕
CDC	16 poles + ⊕

page:

69
77
100
101
105

hoods with 2 pegs

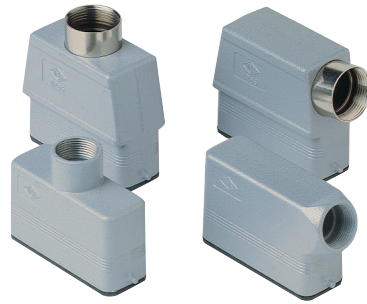

hoods with 2 pegs, double top entry

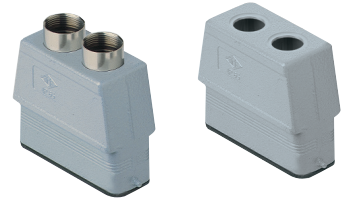

description	part No.	entry Pg	part No.	entry M	part No.	entry Pg	part No.	entry M
with pegs, side entry	<b>CZO 25 L</b>	16	<b>MZO 25 L20</b>	20				
with pegs, side entry			<b>MZO 25 L25</b>	25				
with pegs, side entry, high construction	<b>CZAO 25 L16</b>	16	<b>MZAO 25 L20</b>	20				
with pegs, side entry, high construction	<b>CZAO 25 L21</b>	21	<b>MZAO 25 L25</b>	25				
with pegs, top entry	<b>CZV 25 L</b>	16	<b>MZV 25 L20 **</b>	20				
with pegs, top entry, high construction	<b>CZAV 25 L16</b>	16	<b>MZAV 25 L20</b>	20				
with pegs, top entry, high construction	<b>CZAV 25 L21</b>	21	<b>MZAV 25 L25</b>	25				
with pegs, side entry, high construction, without adaptor *	<b>CZFO 25 L16</b>	16	<b>MZFO 25 L20</b>	20				
with pegs, side entry, high construction, without adaptor *	<b>CZFO 25 L21</b>	21	<b>MZFO 25 L25</b>	25				
with pegs, top entry, high construction, without adaptor *	<b>CZFV 25 L16</b>	16	<b>MZFV 25 L20</b>	20				
with pegs, top entry, high construction, without adaptor *	<b>CZFV 25 L21</b>	21	<b>MZFV 25 L25</b>	25				
with pegs for 1 lever, high construction					<b>CZAV 25 L216</b>	16 x 2	<b>MZAV 25 L220</b>	20 x 2
with pegs for 1 lever, high construction, without adaptor *					<b>CZFV 25 L216</b>	16 x 2	<b>MZFV 25 L220</b>	20 x 2

\* enclosure without adaptor, threaded on the body, to be used only with a complete cable gland.

\*\* can only be used with a complete cable gland (to be purchased separately)

**CZO L and MZO L**

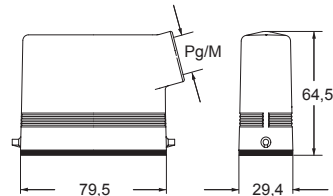

**CZAO L - MZAO L and CZAV L - MZAV L**

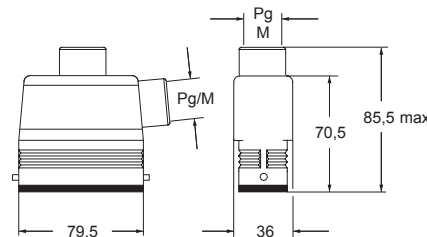

**CZV L and MZV L**

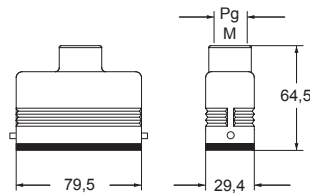

**CZFO L - MZFO L and CZFV L - MZFV L**

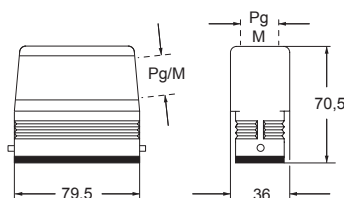

**CZAV/CZFV L2 and (MZAV)/MZFV L2**

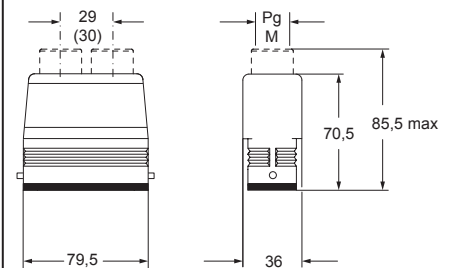

**CAIUS** Type 4/4X/12



IP66 if hoods with fused pegs and without adaptors coupled with IP67 housings



# CZ and MZ IL-BRID standard version

inserts		page:
CD	25 poles + ⊕	69
CDD	38 poles + ⊕	77
CDA	16 poles + ⊕	100
CSAH	16 poles + ⊕	101
CDC	16 poles + ⊕	105

## hoods with single lever



## covers



description	part No.	entry Pg	part No	entry M	part No. (with eyelet)	part No. (with loop)
with single lever, top entry	<b>CZV 25 LG</b>	16	<b>MZV 25 LG20</b>	20		
with pegs and gasket (for 1 lever enclosures)					<b>CZC 25 L</b>	<b>CZC 25 SL</b>
with lever (for enclosures with pegs)						<b>CZC 25 LG</b>

Cover versions L and LG cannot be used together with coding pins.  
If this application is required, please contact ILME SpA.

### CZV LG and MZV LG

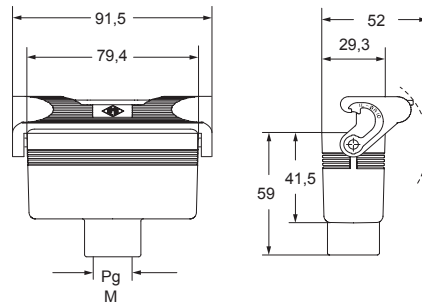

### CZC L (SL)

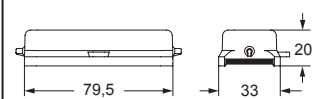

### CZC LG

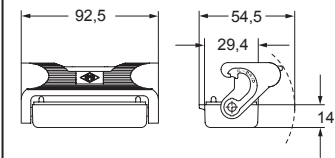

### For fixing on housings

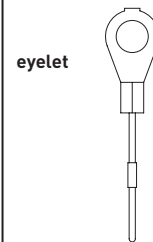

### For fixing on hoods

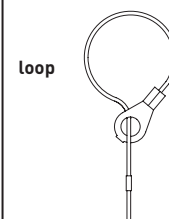

**CAUS**® Type 4/4X/12



# CZAC IL-BRID standard version

inserts		page:
<b>size "49.16"</b>		
CD	15 poles + ⊕	68
CDA	10 poles + ⊕	98
CSAH	10 poles + ⊕	99
CDC	10 poles + ⊕	104
MIXO	1 module	234 - 286
<b>size "66.16"</b>		
CD	25 poles + ⊕	69
CDD	38 poles + ⊕	77
CDA	16 poles + ⊕	100
CSAH	16 poles + ⊕	101
CDC	16 poles + ⊕	105

hoods without entry, to be drilled



hoods without entry, to be drilled



description

part No.  
with 2 pegs

part No.  
with 2 pegs

with pegs, high construction  
used with enclosures size "49.16"

**CZAC 15 L**

with pegs, high construction  
used with enclosures size "66.16"

**CZAC 25 L**

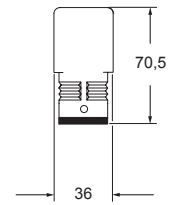
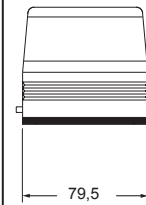
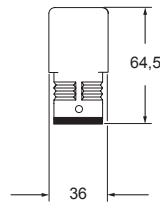
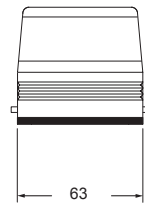

IL-BRID



Type  
4/4X/12



## CZ7 - MZ7

### Rigid coupling

Enclosures with rigid stainless steel lever to assure an IP66/IP67/IP69 dust and watertight seal.



#### SUM-UP

- ☑ **C7 series: V-TYPE stainless steel locking lever, vertical closing**
- ☑ **sizes 44.27, 57.27, 77.27, 104.27**
- ☑ **with and without hinged cover (except size 57.27)**
- ☑ **bulkhead or surface mounting**
- ☑ **recommended in case of vibrations or heavy weight of cables**
  
- ☑ **CZ7 series: stainless steel locking lever, rigid**
- ☑ **sizes 49.16, 66.16**
- ☑ **with and without hinged cover**
- ☑ **bulkhead or surface mounting**
- ☑ **recommended in case of vibrations or heavy weight of cables.**
  
- ✔ **IP66/IP69, IP66/IP67/IP69 degrees of protection according to model**

#### ✍ Characteristics of materials for CZ and MZ series

- Made of die cast aluminium alloy;
- with epoxy-polyester thermosetting powder coating;
- gaskets in anti-aging, oil-resistant, grease-resistant and fuel-resistant vinyl nitrile elastomer;
- locking device integrally in stainless steel;
- ambient temperature range: -40 °C / +125 °C

# CZ7 - MZ7 standard version RIGID LEVER

<b>inserts</b>		<b>page:</b>
CD	15 poles + ⊕	68
CDA	10 poles + ⊕	98
CSAH	10 poles + ⊕	99
CDC	10 poles + ⊕	104
MIXO	1 module	234 - 286

## bulkhead mounting housings with single lever



### STAINLESS STEEL LEVER

## surface mounting housings with single lever

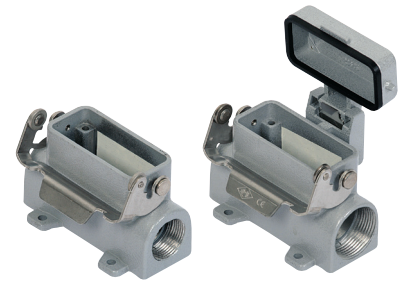

### STAINLESS STEEL LEVER

description	part No.	part No.	entry M
with single lever	<b>CZ7I 15 L</b>	<b>MZ7P 15 L25</b>	25
with single lever and cover	<b>CZ7I 15 LS</b>	<b>MZ7P 15 L225</b>	25 x 2
with single lever		<b>MZ7P 15 LS25</b>	25
with single lever and cover		<b>MZ7P 15LS225</b>	25 x 2

panel cut-out for bulkhead mounting housings

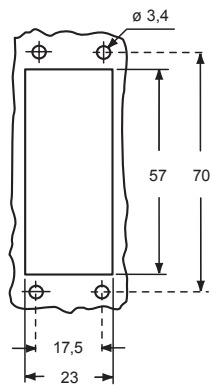

**Hoods**  
(page 376)

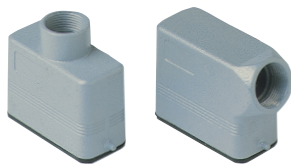

### CZ7I L

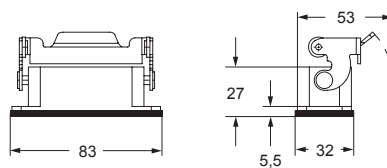

### CZ7I LS

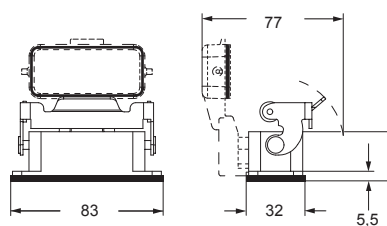

### MZ7P L

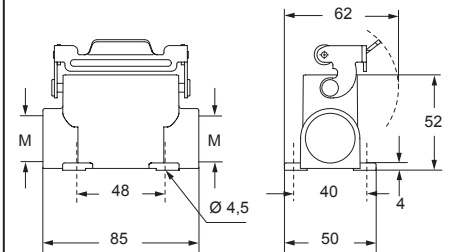

### MZ7P LS

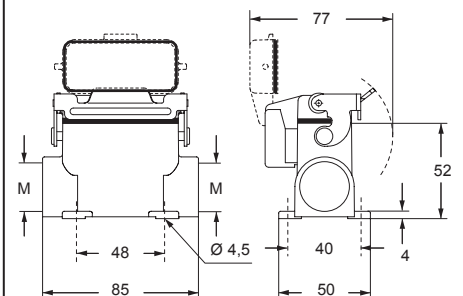

The rigid lever, offers an IP66/IP67 protection rating (according to EN 60529) when fitted with a complete and coupled connector and used with ILME standard hoods in die cast aluminum with pegs (without adapter).

For bulkhead mounting housings, IP66/IP67 protection rating is guaranteed for mounting on a sufficiently rigid panel; use M3 screws of suitable length (negligible surface buckling when subjected to tightening torque on the fixing screws of 0,9 - 1 Nm or deformation caused by the weight of the complete connector).

In addition, the panel surface in contact with the flange gasket of the bulkhead mounting housings must be free from defects (deep scratches, grooves, burrs) that could negatively affect the performance of the gasket.



# CZ7 - MZ7 standard version RIGID LEVER

inserts		page:
CD	25 poles + ⊕	69
CDD	38 poles + ⊕	77
CDA	16 poles + ⊕	100
CSAH	16 poles + ⊕	101
CDC	16 poles + ⊕	105

## bulkhead mounting housings with single lever



### STAINLESS STEEL LEVER

## surface mounting housings with single lever

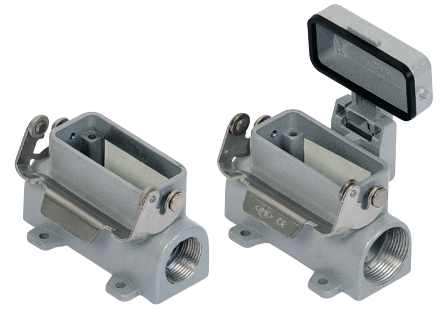

### STAINLESS STEEL LEVER

description	part No.	part No.	entry M
with single lever	<b>CZ7I 25 L</b>	<b>MZ7P 25 L25</b>	25
with single lever and cover	<b>CZ7I 25 LS</b>	<b>MZ7P 25 L225</b>	25 x 2
with single lever		<b>MZ7P 25 LS25</b>	25
with single lever and cover		<b>MZ7P 25LS225</b>	25 x 2

#### panel cut-out for bulkhead mounting housings

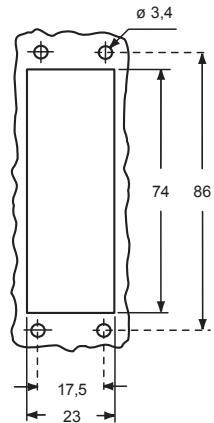

#### Hoods (page 380)

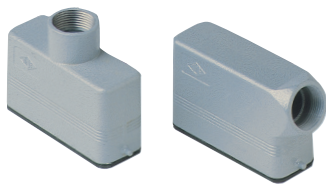

#### CZ7I L

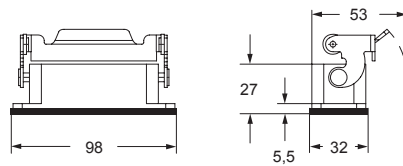

#### CZ7I LS

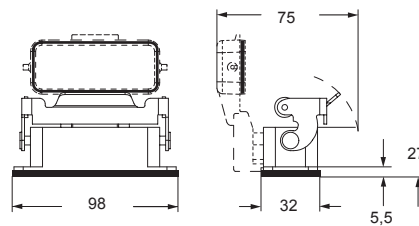

#### MZ7P L

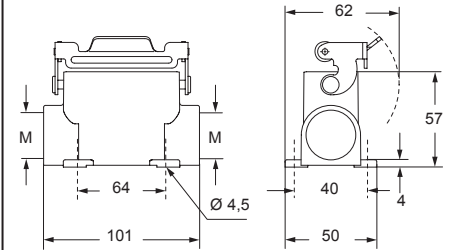

#### MZ7P LS

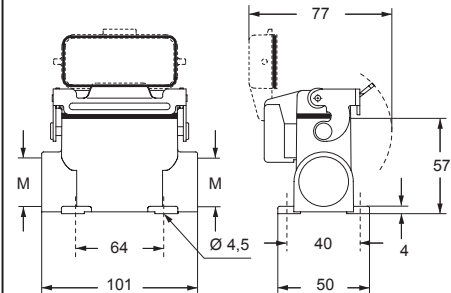

The rigid lever, offers an IP66/IP67 protection rating (according to EN 60529) when fitted with a complete and coupled connector and used with ILME standard hoods in die cast aluminum with pegs (without adapter).

For bulkhead mounting housings, IP66/IP67 protection rating is guaranteed for mounting on a sufficiently rigid panel; use M3 screws of suitable length (negligible surface buckling when subjected to tightening torque on the fixing screws of 0,9 - 1 Nm or deformation caused by the weight of the complete connector).

In addition, the panel surface in contact with the flange gasket of the bulkhead mounting housings must be free from defects (deep scratches, grooves, burrs) that could negatively affect the performance of the gasket.



## C-TYPE

### The classic choice

This series has been developed for application in electrical and electronic machinery, control units, electrical panels, control equipment, in industrial environments and in general, wherever a reliable and easily disconnectable connection is required for power and signal circuits.



#### SUM-UP

📌 **The inserts of the CMCE series (except the 16+2 poles) and of the CMSH series may use standard enclosures also for uses of up to 830V.**

✔ **UL certified for USA and Canada for Type 4, 4X (outdoor use) and 12 (indoor use) degrees of protection (enclosure type rating), marked on the packaging.**  
IP65 or IP66/IP69 degrees of protection according to model.

#### ✍ **Characteristics of materials for CH, CA and MH, MA, MF series**

- Made of die cast aluminium alloy;
- with epoxy-polyester thermosetting powder coating;
- gaskets in anti-aging, oil-resistant, grease-resistant and fuel-resistant vinyl nitrile elastomer;
- locking device with levers, springs and pins in stainless steel;
- lever handles in self-extinguishing thermoplastic material reinforced with glass fibres, UL approved (for CH, CA and MH, MA enclosures);
- ambient temperature range: -40 °C / +125 °C.



# CH C-TYPE standard version

inserts		page:
CDD	24 poles + ⊕	76
CDS	9 poles + ⊕	-
CDSH	9 poles + ⊕	86
CDSH NC	6 poles + ⊕	95
CNE	6 poles + ⊕	110
CSE	6 poles + ⊕	-
CSH	6 poles + ⊕	110
CSH S	6 poles + ⊕	122
CCE	6 poles + ⊕	130
CSS	6 poles + ⊕	148
CT, CTSE (16A) *)	6 poles + ⊕	160
CQE	10 poles + ⊕	168
MIXO	2 modules	232 - 287

\*) can be used only in bulkhead mounting housings

## bulkhead mounting housings with single lever



## bulkhead mounting housings with 2 pegs



description	part No.	part No.
with lever	<b>CHI 06 L</b>	
with lever and cover	<b>CHI 06 LS</b>	
with pegs <sup>1)</sup>		<b>CHI 06 LC</b>
with pegs and aluminum cover <sup>1)</sup>		<b>CHI 06 LCS</b>
with pegs and plastic cover <sup>1)</sup>		<b>CHI 06 LCP</b>

<sup>1)</sup> may be combined with enclosures:  
 - CHO/CHV 06 LX  
 - CHO/CHV 06 LX

panel cut-out for bulkhead mounting housings

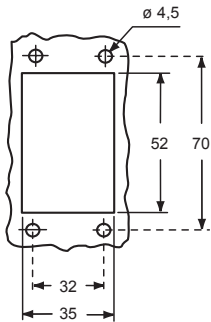

### CHI L

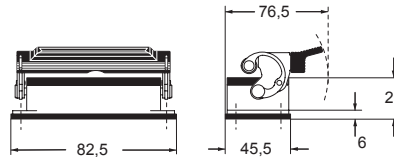

### CHI LS

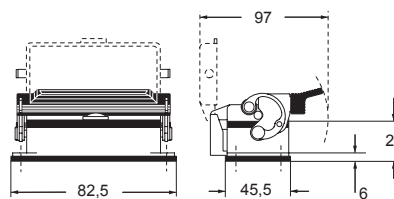

### CHI LC

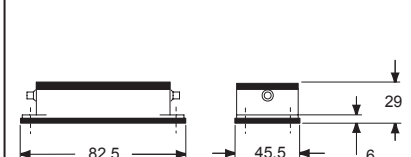

### CHI LCS/LCP

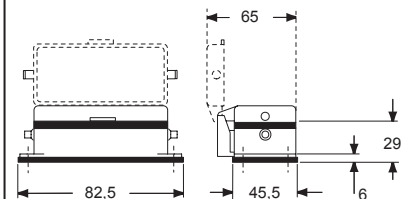

**N.B.:**  
 The enclosures ensure IP66 protection (or IP65 for hinged cover versions) rating when mated and locked with the closing levers. The cover (CS, CP) only ensures mechanical protection, but does not ensure IP65 protection rating.

**CAVUS**® Type 4/4X/12  
 (except enclosures with plastic cover)



# CH - CA and MH - MA C-TYPE standard version

inserts		page:
CDD	24 poles + ⊕	76
CDS	9 poles + ⊕	-
CDSH	9 poles + ⊕	86
CDSH NC	6 poles + ⊕	95
CNE	6 poles + ⊕	110
CSE	6 poles + ⊕	-
CSH	6 poles + ⊕	110
CSH S	6 poles + ⊕	122
CCE	6 poles + ⊕	130
CSS	6 poles + ⊕	148
CQE	10 poles + ⊕	168
MIXO	2 modules	232 - 287

## surface mounting housings with single lever



## angled surface mounting housings with single lever



description	part No.	entry Pg	part No	entry M	part No.	entry M
with lever	<b>CHP 06 L</b>	16	<b>MHP 06 L20</b>	20		
with lever	<b>CHP 06 L2</b>	16 x 2	<b>MHP 06 L220</b>	20 x 2		
with lever, high construction *			<b>MAP 06 L25</b>	25		
with lever, high construction *			<b>MAP 06 L225</b>	25 x 2		
with lever, high construction	<b>CAP 06 L</b>	21	<b>MAP 06 L32</b>	32		
with lever, high construction	<b>CAP 06 L2</b>	21 x 2	<b>MAP 06 L232</b>	32 x 2		
with lever, high construction	<b>CAP 06 L29</b>	29	<b>MAP 06 L40</b>	40		
with lever, high construction	<b>CAP 06 L229</b>	29 x 2	<b>MAP 06 L240</b>	40 x 2		
with lever and cover	<b>CHP 06 LS</b>	16	<b>MHP 06 LS20</b>	20		
with lever and cover	<b>CHP 06 LS2</b>	16 x 2	<b>MHP 06 LS220</b>	20 x 2		
with lever and cover, high construction	<b>CAP 06 LS</b>	21	<b>MAP 06 LS32</b>	32		
with lever and cover, high construction	<b>CAP 06 LS2</b>	21 x 2	<b>MAP 06 LS232</b>	32 x 2		
with lever and cover, high construction	<b>CAP 06 LS29</b>	29	<b>MAP 06 LS40</b>	40		
with lever and cover, high construction	<b>CAP 06 LS229</b>	29 x 2	<b>MAP 06 LS240</b>	40 x 2		
with lever, cable gland entry, closed bulkhead * 1)					<b>MAV 06LG25-F</b>	25

\* to be used only with a complete cable gland (to be purchased separately)

1) versions with M32, Pg 21 or Pg 29 entry on request.

### CHP L - CAP L and MHP L - MAP L

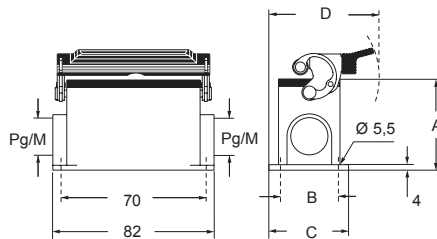

### MAV 06LG25-F

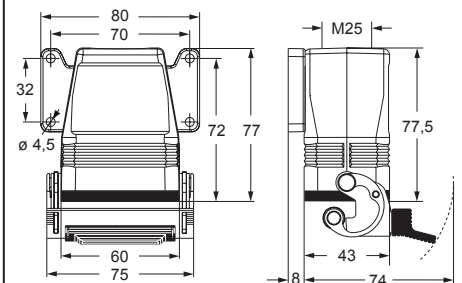

### CHP LS - CAP LS and MHP LS - MAP LS

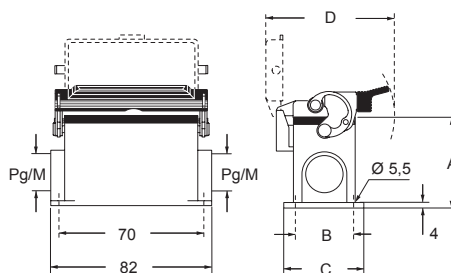

**N.B.:**  
The enclosures ensure IP66 protection (or IP65 for hinged cover versions) rating when mated and locked with the closing levers. The cover (CS, CP) only ensures mechanical protection, but does not ensure IP65 protection rating.

**CAIUS**® Type 4/4X/12



type	A	B	C	D
<b>CHP L / MHP L</b>	53	40	52	79,5
<b>CAP L / MAP L</b>	74	45	57	82
<b>CHP LS / MHP LS</b>	53	40	52	97
<b>CAP LS / MAP LS</b>	74	45	57	97

C-TYPE

# CH - CA - CF and MH - MA - MF C-TYPE standard version

inserts		page:
CDD	24 poles + ⊕	76
CDS	9 poles + ⊕	-
CDSH	9 poles + ⊕	86
CDSH NC	6 poles + ⊕	95
CNE	6 poles + ⊕	110
CSE	6 poles + ⊕	-
CSH	6 poles + ⊕	110
CSH S	6 poles + ⊕	122
CCE	6 poles + ⊕	130
CSS	6 poles + ⊕	148
CQE	10 poles + ⊕	168
MIXO	2 modules	232 - 287

## hoods with 2 pegs



## hoods with 2 pegs

M40 cable entry with 20 mm thread length



description	part No.	entry Pg	part No.	entry M	part No.	entry M
with pegs, side entry	<b>CHO 06 L13</b>	13,5	<b>MHO 06 L20</b>	20		
with pegs, side entry	<b>CHO 06 L16</b>	16	<b>MHO 06 L25</b>	25		
with pegs, side entry, high construction	<b>CAO 06 L21</b>	21	<b>MAO 06 L25</b>	25		
with pegs, side entry, high construction	<b>CAO 06 L29</b>	29	<b>MAO 06 L32</b>	32		
with pegs, side entry, high construction, without adapter *	<b>CFO 06 L21</b>	21	<b>MFO 06 L25</b>	25		
with pegs, side entry, high construction, without adapter *	<b>CFO 06 L29</b>	29	<b>MFO 06 L32</b>	32		
with pegs, side entry, high construction, without adapter *					<b>MFO 06 L40</b>	40
with pegs, top entry	<b>CHV 06 L13</b> <sup>1)</sup>	13,5	<b>MHV 06 L20</b> <sup>1)</sup>	20		
with pegs, top entry	<b>CHV 06 L16</b> <sup>1)</sup>	16	<b>MHV 06 L25</b> <sup>1)</sup>	25		
with pegs, top entry, high construction	<b>CAV 06 L21</b>	21	<b>MAV 06 L25</b>	25		
with pegs, top entry, high construction	<b>CAV 06 L29</b>	29	<b>MAV 06 L32</b>	32		
with pegs, top entry, high construction, without adapter *	<b>CFV 06 L21</b>	21	<b>MFV 06 L25</b>	25		
with pegs, top entry, high construction, without adapter *	<b>CFV 06 L29</b>	29	<b>MFV 06 L32</b>	32		
with pegs, top entry, high construction, without adapter *					<b>MFV 06 L40</b>	40

\* enclosure without adapter, threaded on the body, to be used only with a complete cable gland.

<sup>1)</sup> cannot be used with MIXO series

alternatively, hoods with pegs are coupled with fixed enclosures:

- C-TYPE, IP65/IP66 stainless steel lever, from page 387 to page 391
- C7, IP67 stainless steel lever, page 436
- CV, IP66 stainless steel lever, page 444 and 445

**CHO L (CAO L) and (CFO L)**  
**MHO L (MAO L) and (MFO L)**

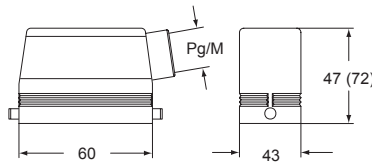

**CHV L (CAV L) and [CFV L]**  
**MHV L (MAV L) and [MFV L]**

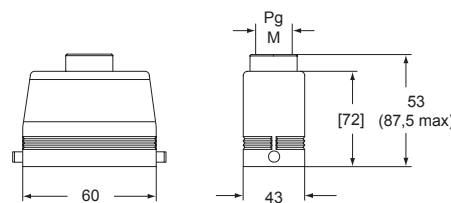

**MFO 06 L40**

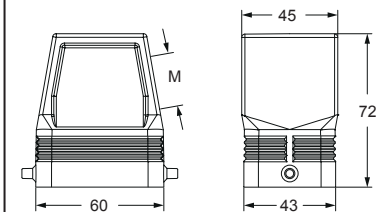

**MFV 06 L40**

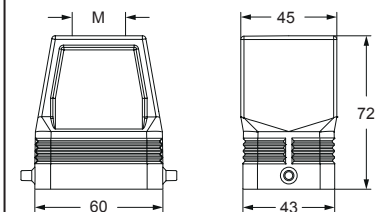

**CAU<sup>®</sup> US** Type 4/4X/12

IP degrees are according to the type of lever and:

cable gland without O-Ring gasket

cable gland equipped with O-Ring gasket  
IP67 if hoods with fused pegs and without adapters coupled with IP67 housings

**CH - CA - CF and MH - MA - MF C-TYPE standard version**

inserts		page:
CDD	24 poles + ⊕	76
CDS	9 poles + ⊕	-
CDSH	9 poles + ⊕	86
CDSH NC	6 poles + ⊕	95
CNE	6 poles + ⊕	110
CSE	6 poles + ⊕	-
CSH	6 poles + ⊕	110
CSH S	6 poles + ⊕	122
CCE	6 poles + ⊕	130
CSS	6 poles + ⊕	148
CQE	10 poles + ⊕	168
MIXO	2 modules	232 - 287

hoods with 1 lever



hoods with 1 lever  
M40 cable entry with 20 mm thread length



description	part No.	entry Pg	part No.	entry M	part No.	entry M
with lever, top entry	<b>CHV 06 LG</b>	16	<b>MHV 06 LG25</b>	25		
with lever, top entry, high construction	<b>CAV 06 LG21</b>	21	<b>MAV 06 LG25</b>	25		
with lever, top entry, high construction	<b>CAV 06 LG29</b>	29	<b>MAV 06 LG32</b>	32		
with lever, side entry, high construction, without adapter *					<b>MFO 06 LG40</b>	40
with lever, top entry, high construction, without adapter *	<b>CFV 06 LG21</b>	21	<b>MFV 06 LG25</b>	25		
with lever, top entry, high construction, without adapter *	<b>CFV 06 LG29</b>	29	<b>MFV 06 LG32</b>	32		
with lever, top entry, high construction, without adapter *					<b>MFV 06 LG40</b>	40

\* enclosure without adapter, threaded on the body, to be used only with a complete cable gland.

alternatively, hoods with pegs are coupled with fixed enclosures:

- C-TYPE, IP65/IP66 stainless steel lever, from page 387 to page 391
- C7, IP67 stainless steel lever, page 436
- CV, IP66 stainless steel lever, page 444 and 445

**CHV LG (CAV LG) and [CFV LG]  
MHV LG (MAV LG) and [MFV LG]**

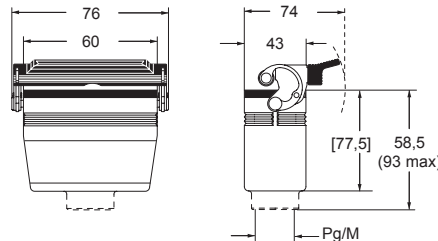

**MFO 06 LG40**

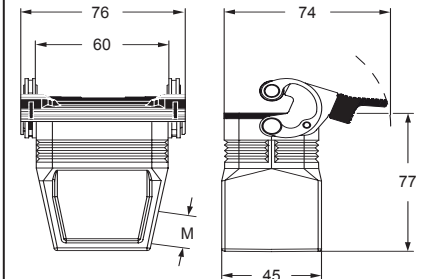

**MFV 06 LG40**

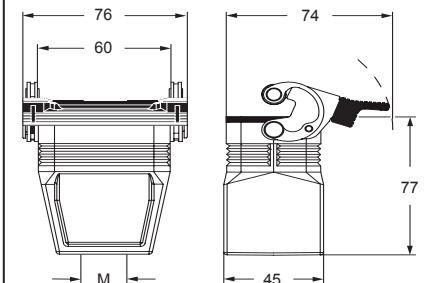

**CALUS** Type 4/4X/12

IP degrees are according to the type of lever and:

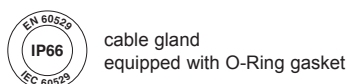
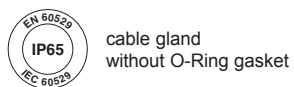

C-TYPE

# CH and MH C-TYPE standard version

inserts		page:
CDD	24 poles + ⊕	76
CDS	9 poles + ⊕	-
CDSH	9 poles + ⊕	86
CDSH NC	6 poles + ⊕	95
CNE	6 poles + ⊕	110
CSE	6 poles + ⊕	-
CSH	6 poles + ⊕	110
CSH S	6 poles + ⊕	122
CCE	6 poles + ⊕	130
CSS	6 poles + ⊕	148
CQE	10 poles + ⊕	168
MIXO	2 modules	232 - 287

## hoods with 1 lever

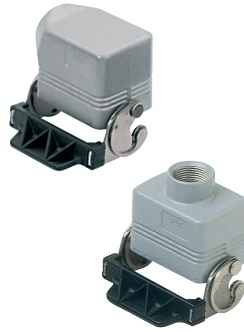

## covers



description	part No.	entry Pg	part No	entry M	part No. (with eyelet)	part No. (with loop)
with lever, without gasket, side entry <sup>1)3)</sup>	<b>CHO 06 LX16</b>	16	<b>MHO 06 LX20</b>	20		
with lever, without gasket, side entry <sup>1)3)</sup>			<b>MHO 06 LX25</b>	25		
with lever, without gasket, top entry <sup>1)3)</sup>	<b>CHV 06 LX16</b>	16	<b>MHV 06 LX20</b>	20		
with lever, without gasket, top entry <sup>1)3)</sup>			<b>MHV 06 LX25</b>	25		
with lever (for hoods with pegs)						<b>CHC 06 LG</b>
with pegs (for enclosures with lever)					<b>CHC 06 L</b>	<b>CHC 06 SL</b>
with pegs and gasket (for hoods with lever) <sup>2)</sup>						<b>CHC 06 LC</b>

<sup>1)</sup> may be combined with enclosures:  
CHI 06 LCS/LCP/LC

<sup>2)</sup> may be combined with enclosures:  
- CHO/CHV 06 LX  
- CHO/CHV 06 LX

<sup>3)</sup> cannot be used with MIXO series

dust protection cover  
**CHCP 06**  
(page 696)



### CHO LX and MHO LX

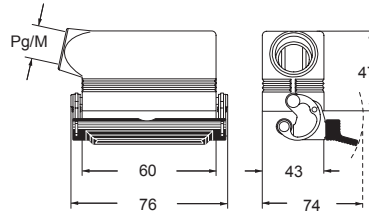

### CHV LX and MHV LX

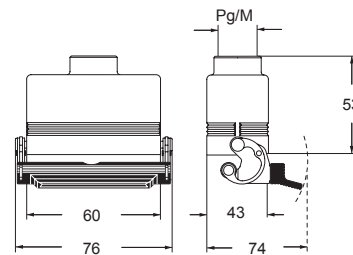

### CHC LG

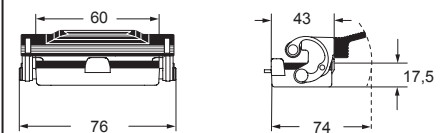

### CHC L (SL)

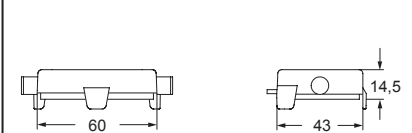

### CHC LC

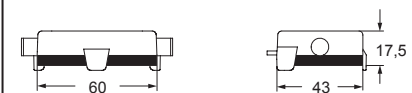

For fixing on housings

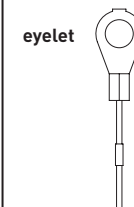

For fixing on hoods

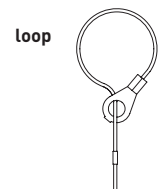

**CUUS** Type 4/4X/12



# CAC C-TYPE standard version

inserts		page:
CDD	24 poles + ⊕	76
CDS	9 poles + ⊕	-
CDSH	9 poles + ⊕	86
CDSH NC	6 poles + ⊕	95
CNE	6 poles + ⊕	110
CSE	6 poles + ⊕	-
CSH	6 poles + ⊕	110
CSH S	6 poles + ⊕	122
CCE	6 poles + ⊕	130
CSS	6 poles + ⊕	148
CQE	10 poles + ⊕	168
MIXO	2 modules	232 - 287

hoods without entry, to be drilled



description

part No.  
with 2 pegs

with pegs, high construction

**CAC 06 L**

alternatively, hoods with pegs are coupled with fixed enclosures:

- C-TYPE, IP65/IP66 stainless steel lever, from page 387 to page 391
- C7, IP67 stainless steel lever, page 436
- CV, IP66 stainless steel lever, page 444 and 445

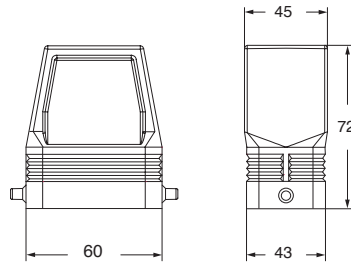

C-TYPE

**CAI<sup>®</sup>US** Type 4/4X/12





# CH C-TYPE standard version

inserts		page:
CDD	42 poles + ⊕	78
CDS	18 poles + ⊕	-
CDSH	18 poles + ⊕	87
CNE	10 poles + ⊕	111
CSE	10 poles + ⊕	-
CSH	10 poles + ⊕	111
CSH S	10 poles + ⊕	123
CCE	10 poles + ⊕	131
CMSH	3+2 (aux) poles + ⊕	136
CMCE	3+2 (aux) poles + ⊕	137
CSS	10 poles + ⊕	149
CT, CTSE (16A) *)	10 poles + ⊕	161
CQE	18 poles + ⊕	169
CX	8/24 poles + ⊕	194
MIXO	3 modules	232 - 287

\*) can be used only in bulkhead mounting housings

## bulkhead mounting housings with 2 levers or 4 pegs



## bulkhead mounting housings with single lever



description	part No.	part No.
with one or two levers	<b>CHI 10</b>	<b>CHI 10 L</b>
with pegs 1)	<b>CHI 10 C</b>	
with pegs and aluminum cover 1)	<b>CHI 10 CS</b>	
with pegs and plastic cover 1)	<b>CHI 10 CP</b>	
with lever and cover		<b>CHI 10 LS</b>

1) may be combined with enclosures:  
 - CHO/CAO 10 X and CHV/CAV 10 X  
 - MHO/MAO 10 X and MHV/MAV 10 X

panel cut-out for bulkhead mounting housings

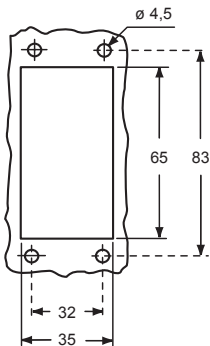

### CHI

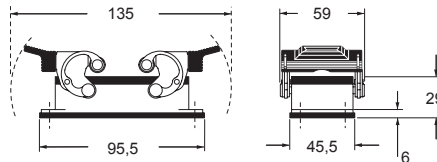

### CHI C

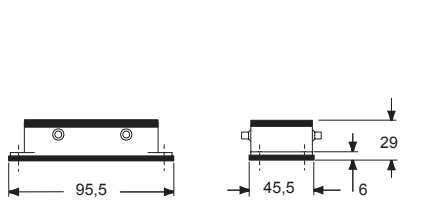

### CHI CS/CP

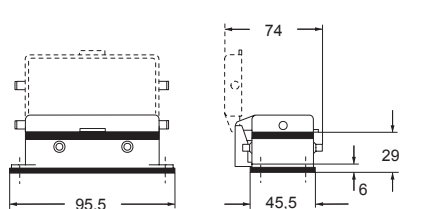

### CHI L

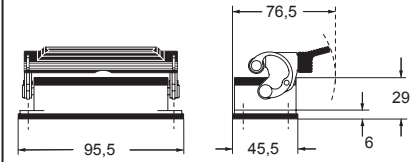

### CHI LS

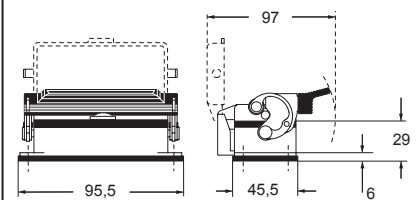

**ANGLED VERSION**  
(page 450)



**N.B.:**  
 The enclosures ensure IP66 protection (or IP65 for hinged cover versions) rating when mated and locked with the closing levers. The cover (CS, CP) only ensures mechanical protection, but does not ensure IP65 protection rating.

**ILME**® Type 4/4X/12  
 (except enclosures with plastic cover)



# CH - CA and MH - MA C-TYPE standard version

inserts		page:
CDD	42 poles + ⊕	78
CDS	18 poles + ⊕	-
CDSH	18 poles + ⊕	87
CNE	10 poles + ⊕	111
CSE	10 poles + ⊕	-
CSH	10 poles + ⊕	111
CSH S	10 poles + ⊕	123
CCE	10 poles + ⊕	131
CMSH	3+2 (aux) poles + ⊕	136
CMCE	3+2 (aux) poles + ⊕	137
CSS	10 poles + ⊕	149
CQE	18 poles + ⊕	169
CX	8/24 poles + ⊕	194
MIXO	3 modules	232 - 287

## surface mounting housings with 2 levers or 4 pegs



## surface mounting housings with single lever



description	part No.	entry Pg	part No	entry M	part No.	entry Pg	part No.	entry M
with lever/s	CHP 10	16	MHP 10.20	20	CHP 10 L	16	MHP 10 L20	20
with lever/s	CHP 10.2	16 x 2	MHP 10.220	20 x 2	CHP 10 L2	16 x 2	MHP 10 L220	20 x 2
with levers, high construction *			MAP 10.25	25				
with levers, high construction *			MAP 10.225	25 x 2				
with lever/s, high construction	CAP 10.21	21	MAP 10.32	32	CAP 10 L	21	MAP 10 L32	32
with lever/s, high construction	CAP 10.221	21 x 2	MAP 10.232	32 x 2	CAP 10 L2	21 x 2	MAP 10 L232	32 x 2
with lever/s, high construction	CAP 10.29	29	MAP 10.40	40	CAP 10 L29	29	MAP 10 L40	40
with lever/s, high construction	CAP 10.229	29 x 2	MAP 10.240	40 x 2	CAP 10 L229	29 x 2	MAP 10 L240	40 x 2
with pegs and aluminum cover 1)	CHP 10 CS	16	MHP 10 CS20	20				
with pegs and aluminum cover 1)	CHP 10 CS2	16 x 2	MHP 10 CS220	20 x 2				
with pegs and aluminum cover, high construction 1)	CAP 10 CS	21	MAP 10 CS32	32				
with pegs and aluminum cover, high construction 1)	CAP 10 CS2	21 x 2	MAP 10 CS232	32 x 2				
with pegs and aluminum cover, high construction 1)	CAP 10 CS29	29	MAP 10 CS40	40				
with pegs and aluminum cover, high construction 1)	CAP 10 CS229	29 x 2	MAP 10 CS240	40 x 2				
with pegs and plastic cover 1)	CHP 10 CP	16	MHP 10 CP20	20				
with pegs and plastic cover 1)	CHP 10 CP2	16 x 2	MHP 10 CP220	20 x 2				
with pegs and plastic cover, high construction 1)	CAP 10 CP	21	MAP 10 CP32	32				
with pegs and plastic cover, high construction 1)	CAP 10 CP2	21 x 2	MAP 10 CP232	32 x 2				
with pegs and plastic cover, high construction 1)	CAP 10 CP29	29	MAP 10 CP40	40				
with pegs and plastic cover, high construction 1)	CAP 10 CP229	29 x 2	MAP 10 CP240	40 x 2				
with lever and aluminium cover	CHP 10 LS	16	MHP 10 LS20	20				
with lever and aluminium cover	CHP 10 LS2	16 x 2	MHP 10 LS220	20 x 2				
with lever and aluminium cover, high construction	CAP 10 LS	21	MAP 10 LS32	32				
with lever and aluminium cover, high construction	CAP 10 LS2	21 x 2	MAP 10 LS232	32 x 2				
with lever and aluminium cover, high construction	CAP 10 LS29	29	MAP 10 LS40	40				
with lever and aluminium cover, high construction	CAP 10 LS229	29 x 2	MAP 10 LS240	40 x 2				

\* to be used only with a complete cable gland (to be purchased separately)

1) may be combined with enclosures:  
 - CHO/CAO 10 X and CHV/CAV 10 X  
 - MHO/MAO 10 X and MHV/MAV 10 X

**N.B.:**  
 The enclosures ensure IP66 protection (or IP65 for hinged cover versions) rating when mated and locked with the closing levers. The cover (CS, CP) only ensures mechanical protection, but does not ensure IP65 protection rating.

### CHP - CAP and MHP - MAP

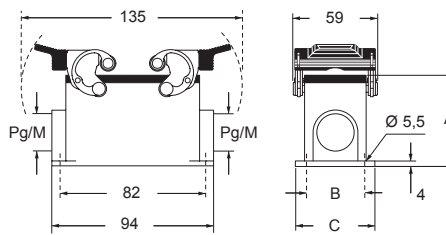

### CHP CS/CP - CAP CS/CP and MHP CS/CP - MAP CS/CP

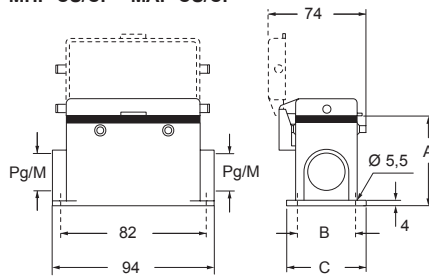

type	A	B	C
CHP / MHP	57	40	52
CAP / MAP	74	45	57
CHP CS / MHP CS	57	40	52
CAP CS / MAP CS	74	45	57
CHP CP / MHP CP	57	40	52
CAP CP / MAP CP	74	45	57

### CHP L - CAP L and MHP L - MAP L

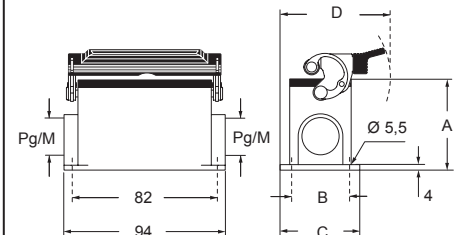

### CHP LS - CAP LS and MHP LS - MAP LS

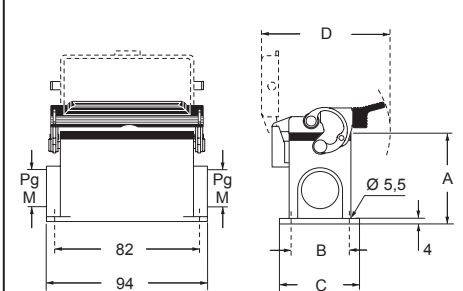

type	A	B	C	D
CHP L / MHP L	57	40	52	79,5
CAP L / MAP L	74	45	57	82
CHP LS / MHP LS	57	40	52	97
CAP LS / MAP LS	74	45	57	97

**CAVUS**® Type 4/4X/12  
 (except enclosures with plastic cover)



# CH - CA - CF and MH - MA - MF C-TYPE standard version

inserts		page:
CDD	42 poles + ⊕	78
CDS	18 poles + ⊕	-
CDSH	18 poles + ⊕	87
CNE	10 poles + ⊕	111
CSE	10 poles + ⊕	-
CSH	10 poles + ⊕	111
CSH S	10 poles + ⊕	123
CCE	10 poles + ⊕	131
CMSH	3+2 (aux) poles + ⊕	136
CMCE	3+2 (aux) poles + ⊕	137
CSS	10 poles + ⊕	149
CQE	18 poles + ⊕	169
CX	8/24 poles + ⊕	194
MIXO	3 modules	232 - 287

## hoods with 4 pegs



## hoods with 4 pegs

M40 cable entry with 20 mm thread length

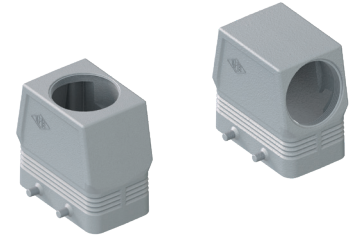

description	part No.	entry Pg	part No.	entry M	part No.	entry Pg	part No.	entry M
with pegs, side entry	<b>CHO 10</b>	16	<b>MHO 10.20</b>	20				
with pegs, side entry			<b>MHO 10.25</b>	25				
with pegs, side entry, high construction	<b>CAO 10.21</b>	21	<b>MAO 10.32</b>	32				
with pegs, side entry, high construction	<b>CAO 10.29</b>	29	<b>MAO 10.40</b>	40				
with pegs, side entry, high construction, without adapter *					<b>CFO 10.21</b>	21	<b>MFO 10.32</b>	32
with pegs, side entry, high construction, without adapter *					<b>CFO 10.29</b>	29	<b>MFO 10.40</b>	40
with pegs, top entry	<b>CHV 10</b>	16	<b>MHV 10.20 **</b>	20				
with pegs, top entry			<b>MHV 10.25</b>	25				
with pegs, top entry, high construction	<b>CAV 10.21</b>	21	<b>MAV 10.32</b>	32				
with pegs, top entry, high construction	<b>CAV 10.29</b>	29	<b>MAV 10.40</b>	40				
with pegs, top entry, high construction, without adapter *					<b>CFV 10.21</b>	21	<b>MFV 10.32</b>	32
with pegs, top entry, high construction, without adapter *					<b>CFV 10.29</b>	29	<b>MFV 10.40</b>	40
with pegs, frontal entry, high construction	<b>CAF 10</b>	16	<b>MAF 10.20</b>	20				
with pegs, frontal entry, high construction, without adapter *	<b>CFF 10</b>	16	<b>MFF 10.20</b>	20				

\* enclosure without adapter, threaded on the body, to be used only with a complete cable gland.

\*\* can only be used with a complete cable gland (to be purchased separately).

alternatively, hoods with pegs are coupled with fixed enclosures:

- C-TYPE, IP65/IP66 stainless steel lever, from page 393 to page 400
- C7, IP67 stainless steel lever, page 438
- CV, IP66 stainless steel lever, page 448 and 449

### CHO (CAO) and MHO (MAO)

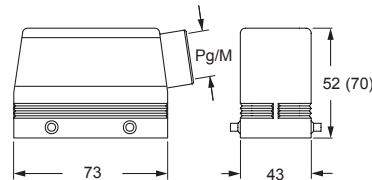

### CFO and MFO

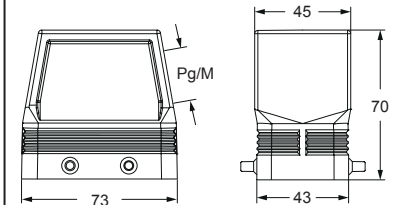

### CHV (CAV) and MHV (MAV)

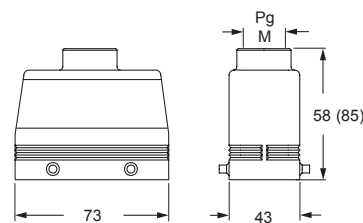

### CFV and MFV

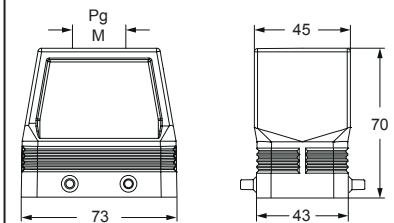

### CAF/CFF and MAF/MFF

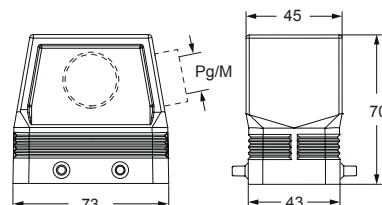

**CALUS** Type 4/4X/12

IP degrees are according to the type of lever and:

cable gland without O-Ring gasket

cable gland equipped with O-Ring gasket  
IP67 if hoods with fused pegs and without adapters coupled with IP67 housings

# CH - CA - CF and MH - MA - MF C-TYPE standard version

inserts		page:
CDD	42 poles + ⊕	78
CDS	18 poles + ⊕	-
CDSH	18 poles + ⊕	87
CNE	10 poles + ⊕	111
CSE	10 poles + ⊕	-
CSH	10 poles + ⊕	111
CSH S	10 poles + ⊕	123
CCE	10 poles + ⊕	131
CMSH	3+2 (aux) poles + ⊕	136
CMCE	3+2 (aux) poles + ⊕	137
CSS	10 poles + ⊕	149
CQE	18 poles + ⊕	169
CX	8/24 poles + ⊕	194
MIXO	3 modules	232 - 287

## hoods with 2 pegs



## hoods with 2 pegs M40 cable entry with 20 mm thread length



description	part No.	entry Pg	part No	entry M	part No.	entry Pg	part No.	entry M
with pegs, side entry	<b>CHO 10 L</b>	16	<b>MHO 10 L20</b>	20				
with pegs, side entry			<b>MHO 10 L25</b>	25				
with pegs, side entry, high construction	<b>CAO 10 L21</b>	21	<b>MAO 10 L32</b>	32				
with pegs, side entry, high construction	<b>CAO 10 L29</b>	29	<b>MAO 10 L40</b>	40				
with pegs, side entry, high construction, without adapter *					<b>CFO 10 L21</b>	21	<b>MFO 10 L32</b>	32
with pegs, side entry, high construction, without adapter *					<b>CFO 10 L29</b>	29	<b>MFO 10 L40</b>	40
with pegs, top entry	<b>CHV 10 L</b>	16	<b>MHV 10 L20 **</b>	20				
with pegs, top entry			<b>MHV 10 L25</b>	25				
with pegs, top entry, high construction	<b>CAV 10 L21</b>	21	<b>MAV 10 L32</b>	32				
with pegs, top entry, high construction	<b>CAV 10 L29</b>	29	<b>MAV 10 L40</b>	40				
with pegs, top entry, high construction, without adapter *					<b>CFV 10 L21</b>	21	<b>MFV 10 L32</b>	32
with pegs, top entry, high construction, without adapter *					<b>CFV 10 L29</b>	29	<b>MFV 10 L40</b>	40

\* enclosure without adapter, threaded on the body, to be used only with a complete cable gland.

\*\* can only be used with a complete cable gland (to be purchased separately).

alternatively, hoods with pegs are coupled with fixed enclosures:

- C-TYPE, IP65/IP66 stainless steel lever, from page 393 to page 400
- C7, IP67 stainless steel lever, page 438
- CV, IP66 stainless steel lever, page 448 and 449

### CHO L (CAO L) and MHO L (MAO L)

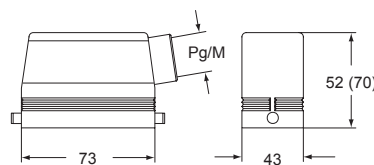

### CFO L and MFO L

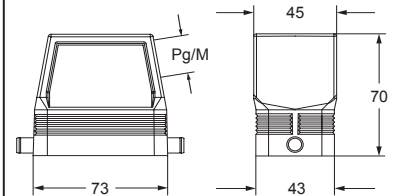

### CHV L (CAV L) and MHV L (MAV L)

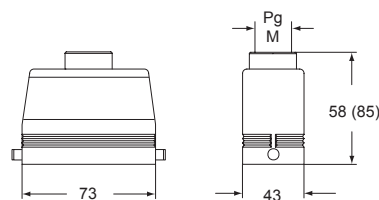

### CFV L and MFV L

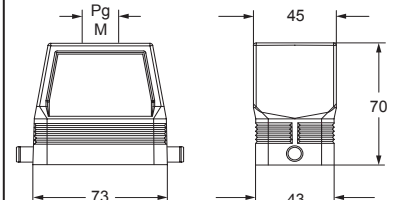

**CALUS** Type 4/4X/12

IP degrees are according to the type of lever and:

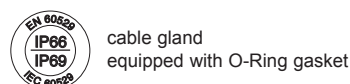
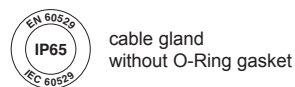

# CH - CF and MA - MF C-TYPE standard version

inserts		page:
CDD	42 poles + ⊕	78
CDS	18 poles + ⊕	-
CDSH	18 poles + ⊕	87
CNE	10 poles + ⊕	111
CSE	10 poles + ⊕	-
CSH	10 poles + ⊕	111
CSH S	10 poles + ⊕	123
CCE	10 poles + ⊕	131
CMSH	3+2 (aux) poles + ⊕	136
CMCE	3+2 (aux) poles + ⊕	137
CSS	10 poles + ⊕	149
CQE	18 poles + ⊕	169
CX	8/24 poles + ⊕	194
MIXO	3 modules	232 - 287

## hoods with double top entry



description	part No.	entry Pg	part No	entry M
with pegs for two levers used with enclosures size "57.27"	<b>CAV 10.213</b>	13,5 x 2	<b>MAV 10.220</b>	20 x 2
with pegs for two levers, without adapter * used with enclosures size "57.27"	<b>CFV 10.213</b>	13,5 x 2	<b>MFV 10.220</b>	20 x 2

\* enclosure without adapter, threaded on the body, to be used only with a complete cable gland.

alternatively, hoods with pegs are coupled with fixed enclosures:

- C-TYPE, IP65/IP66 stainless steel lever, from page 393 to page 400
- C7, IP67 stainless steel lever, page 438
- CV, IP66 stainless steel lever, page 448 and 449

## CAV/CFV and MAV/MFV

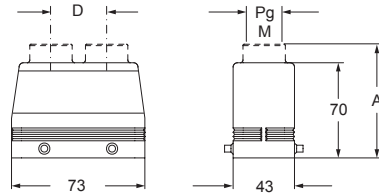

part No.	A	B
<b>CAV 10.213 - MAV 10.220</b>	82 (84,5)	26 (28,5)
<b>CFV 10.213 - MFV 10.220</b>	-	28,5 (26)

**CAV<sup>®</sup>US** Type 4/4X/12



IP67 if hoods with fused pegs and without adapters coupled with IP67 housings

**CH - CA - CF and MH - MA - MF C-TYPE standard version**

inserts		page:
CDD	42 poles + ⊕	78
CDS	18 poles + ⊕	-
CDSH	18 poles + ⊕	87
CNE	10 poles + ⊕	111
CSE	10 poles + ⊕	-
CSH	10 poles + ⊕	111
CSH S	10 poles + ⊕	123
CCE	10 poles + ⊕	131
CMSH	3+2 (aux) poles + ⊕	136
CMCE	3+2 (aux) poles + ⊕	137
CSS	10 poles + ⊕	149
CQE	18 poles + ⊕	169
CX	8/24 poles + ⊕	194
MIXO	3 modules	232 - 287

**hoods with 2 levers**



**hoods with 2 levers  
M40 cable entry with 20 mm thread length**



description	part No.	entry Pg	part No	entry M	part No.	entry M
with levers and gasket, side entry, high construction, without adapter *					<b>MFO 10 G40</b>	40
with levers and gasket, top entry	<b>CHV 10 G</b>	16	<b>MHV 10 G25</b>	25		
with levers and gasket, top entry, high construction	<b>CAV 10 G</b>	21	<b>MAV 10 G25</b>	25		
with levers and gasket, top entry, high construction	<b>CAV 10 G29</b>	29	<b>MAV 10 G32</b>	32		
with levers and gasket, top entry, high construction, without adapter *	<b>CFV 10 G</b>	21	<b>MFV 10 G25</b>	25		
with levers and gasket, top entry, high construction, without adapter *	<b>CFV 10 G29</b>	29	<b>MFV 10 G32</b>	32		
with levers and gasket, top entry, high construction, without adapter *					<b>MFV 10 G40</b>	40

\* enclosure without adapter, threaded on the body, to be used only with a complete cable gland.

**CHV G (CAV G) and [CFV G],  
MHV G (MAV G) and [MFV G]**

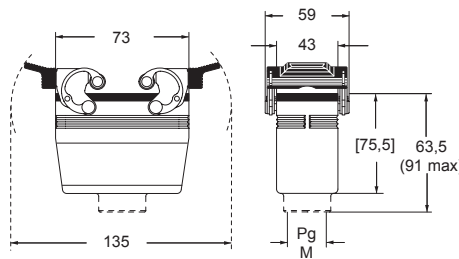

**MFO 10 G40**

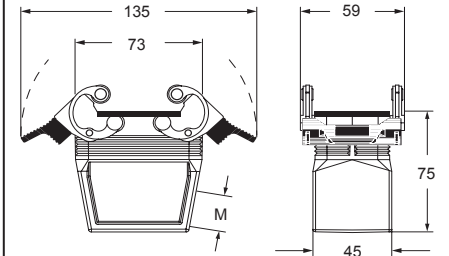

**MFV 10 G40**

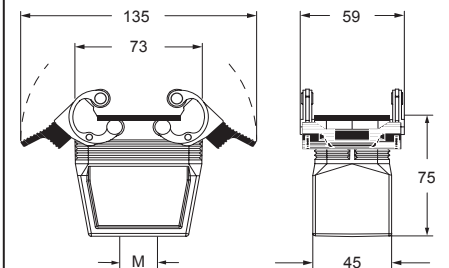

**CALUS** Type 4/4X/12

IP degrees are according to the type of lever and:

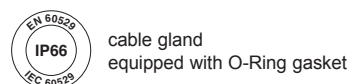
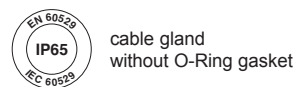



# CH - CA - CF and MH - MA - MF C-TYPE standard version

inserts		page:
CDD	42 poles + ⊕	78
CDS	18 poles + ⊕	-
CDSH	18 poles + ⊕	87
CNE	10 poles + ⊕	111
CSE	10 poles + ⊕	-
CSH	10 poles + ⊕	111
CSH S	10 poles + ⊕	123
CCE	10 poles + ⊕	131
CMSH	3+2 (aux) poles + ⊕	136
CMCE	3+2 (aux) poles + ⊕	137
CSS	10 poles + ⊕	149
CQE	18 poles + ⊕	169
CX	8/24 poles + ⊕	194
MIXO	3 modules	232 - 287

## hoods with 1 lever



## hoods with 1 lever

M40 cable entry with 20 mm thread length



description	part No.	entry Pg	part No	entry M	part No.	entry M
with lever and gasket, side entry, high construction, without adapter *					<b>MFO 10 LG40</b>	40
with lever and gasket, top entry	<b>CHV 10 LG</b>	16	<b>MHV 10 LG25</b>	25		
with lever and gasket, top entry, high construction	<b>CAV 10 LG21</b>	21	<b>MAV 10 LG25</b>	25		
with lever and gasket, top entry, high construction	<b>CAV 10 LG29</b>	29	<b>MAV 10 LG32</b>	32		
with lever and gasket, top entry, high construction, without adapter *	<b>CFV 10 LG21</b>	21	<b>MFV 10 LG25</b>	25		
with lever and gasket, top entry, high construction, without adapter *	<b>CFV 10 LG29</b>	29	<b>MFV 10 LG32</b>	32		
with lever and gasket, top entry, high construction, without adapter *					<b>MFV 10 LG40</b>	40

\* enclosure without adapter, threaded on the body, to be used only with a complete cable gland.

### CHV LG (CAV LG) and [CFV LG], MHV LG (MAV LG) and [MFV LG]

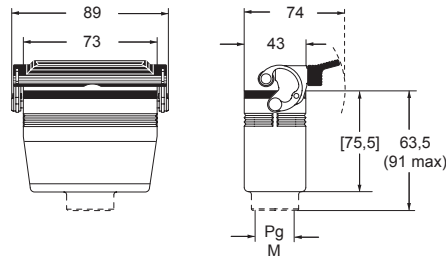

### MFO 10 LG40

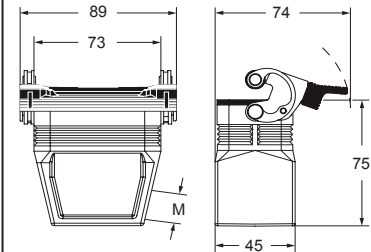

### MFV 10 LG40

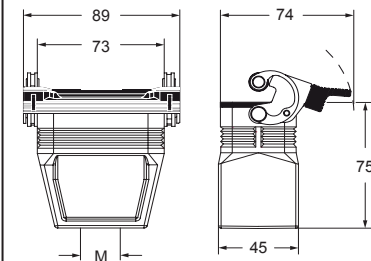

**CRUS** Type 4/4X/12

IP degrees are according to the type of lever and:

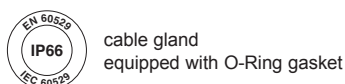
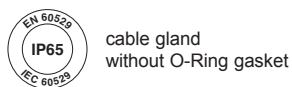

# CH - CA and MH - MA C-TYPE standard version

inserts		page:
CDD	42 poles + ⊕	78
CDS	18 poles + ⊕	-
CDSH	18 poles + ⊕	87
CNE	10 poles + ⊕	111
CSE	10 poles + ⊕	-
CSH	10 poles + ⊕	111
CSH S	10 poles + ⊕	123
CCE	10 poles + ⊕	131
CMSH	3+2 (aux) poles + ⊕	136
CMCE	3+2 (aux) poles + ⊕	137
CSS	10 poles + ⊕	149
CQE	18 poles + ⊕	169
CX	8/24 poles + ⊕	194
MIXO	3 modules	232 - 287

## hoods with 2 levers

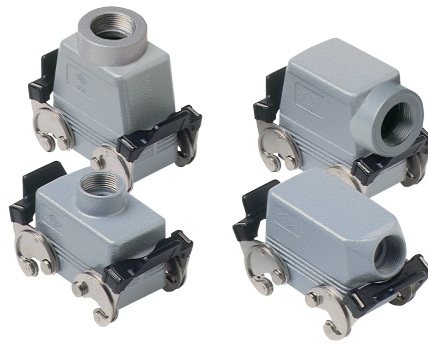

## covers

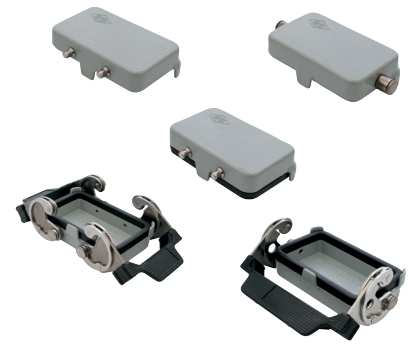

description	part No.	entry Pg	part No	entry M	part No. (with eyelet)	part No. (with loop)
with levers, side entry <sup>1)</sup>	<b>CHO 10 X</b>	16	<b>MHO 10 X20</b>	20		
with levers, side entry <sup>1)</sup>			<b>MHO 10 X25</b>	25		
with levers, side entry, high construction <sup>1)</sup>	<b>CAO 10 X</b>	21	<b>MAO 10 X32</b>	32		
with levers, side entry, high construction <sup>1)</sup>	<b>CAO 10 X29</b>	29	<b>MAO 10 X40</b>	40		
with levers, top entry <sup>1)</sup>	<b>CHV 10 X</b>	16	<b>MHV 10 X20 **</b>	20		
with levers, top entry <sup>1)</sup>			<b>MHV 10 X25</b>	25		
with levers, top entry, high construction <sup>1)</sup>	<b>CAV 10 X</b>	21	<b>MAV 10 X32</b>	32		
with levers, top entry, high construction <sup>1)</sup>	<b>CAV 10 X29</b>	29	<b>MAV 10 X40</b>	40		
with 4 pegs (for enclosures with 2 levers with gasket)					<b>CHC 10</b>	<b>CHC 10 S</b>
with 4 pegs and gasket (for enclosures with 2 levers) <sup>2)</sup>						<b>CHC 10 C</b>
with 2 pegs (for enclosures with 1 lever with gasket)					<b>CHC 10 L</b>	<b>CHC 10 SL</b>
with 2 levers (for hoods with 4 pegs)						<b>CHC 10 G</b>
with 1 lever (for hoods with 2 pegs)						<b>CHC 10 LG</b>

<sup>1)</sup> may be combined with enclosures:

- CHI/CHP/CAP 10 CS/CP/C
- MHP/MAP 10 CS/CP

<sup>2)</sup> may be combined with enclosures:

- CHO/CAO 10 X and CHV/CAV 10 X
- MHO/MAO 10 X and MHV/MAV 10 X

\*\* can only be used with a complete cable gland (to be purchased separately).

### CHO X (CAO X) and MHO X (MAO X)

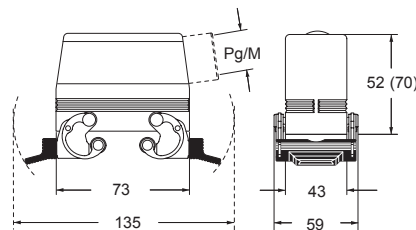

### CHV X (CAV X) and MHV X (MAV X)

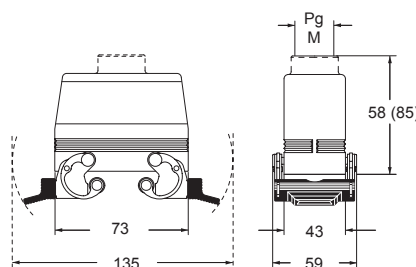

dust protection cover  
**CHCP 10**  
(page 696)



### CHC (S)



### CHC C



### CHC L (SL)



### CHC G

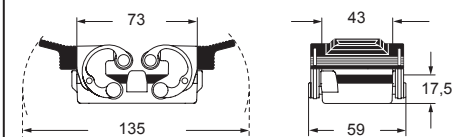

### CHC LG

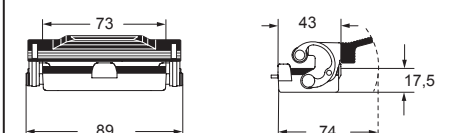

For fixing on housings

eyelet

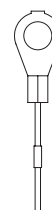

For fixing on hoods

loop

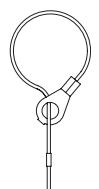

**CAIUS** Type 4/4X/12



# CAC C-TYPE standard version

inserts		page:
CDD	42 poles + ⊕	78
CDS	18 poles + ⊕	-
CDSH	18 poles + ⊕	87
CNE	10 poles + ⊕	111
CSE	10 poles + ⊕	-
CSH	10 poles + ⊕	111
CSH S	10 poles + ⊕	123
CCE	10 poles + ⊕	131
CMSH	3+2 (aux) poles + ⊕	136
CMCE	3+2 (aux) poles + ⊕	137
CSS	10 poles + ⊕	149
CQE	18 poles + ⊕	169
CX	8/24 poles + ⊕	194
MIXO	3 modules	232 - 287

## hoods without entry, to be drilled



## hoods without entry, to be drilled



description	part No. with 4 pegs	part No. with 2 pegs
-------------	-------------------------	-------------------------

with pegs, high construction

### CAC 10

### CAC 10 L

alternatively, hoods with pegs are coupled with fixed enclosures:

- C-TYPE, IP65/IP66 stainless steel lever, from page 393 to page 400
- C7, IP67 stainless steel lever, page 438
- CV, IP66 stainless steel lever, page 448 and 449

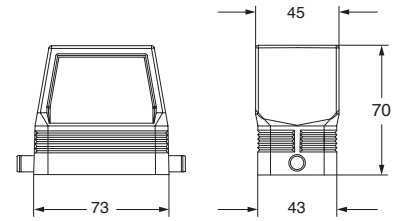
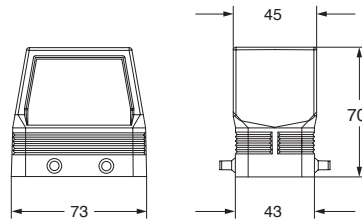

**CAIUS**® Type 4/4X/12



# CH C-TYPE standard version

inserts		page:
CD	40 poles + ⊕	70
CDD	72 poles + ⊕	79
CDS	27 poles + ⊕	-
CDSH	27 poles + ⊕	88
CNE	16 poles + ⊕	112
CSE	16 poles + ⊕	-
CSH	16 poles + ⊕	112
CSH S	16 poles + ⊕	124
CCE	16 poles + ⊕	132
CMSH, CMCE	6+2 (aux) poles + ⊕	138 - 139
CSS	16 poles + ⊕	150
CT, CTS (10A) *)	40 poles + ⊕	156
CT, CTSE (16A) *)	16 poles + ⊕	162
CQE	32 poles + ⊕	170
CQEE	40 poles + ⊕	176
CP	6 poles + ⊕	178
CX	6/12, 6/36 and 12/2 poles + ⊕	197 - 199
CX	4/0 and 4/2 poles + ⊕	200 - 201
MIXO	4 modules	232 - 287

\*) can be used only in bulkhead mounting housings

## bulkhead mounting housings with 2 levers or 4 pegs



## bulkhead mounting housings with single lever



description	part No.	part No.
with one or two levers	<b>CHI 16</b>	<b>CHI 16 L</b>
with pegs <sup>1)</sup>	<b>CHI 16 C</b>	
with pegs and aluminum cover <sup>1)</sup>	<b>CHI 16 CS</b>	
with pegs and plastic cover <sup>1)</sup>	<b>CHI 16 CP</b>	
with lever and aluminum cover		<b>CHI 16 LS</b>

<sup>1)</sup> may be combined with enclosures:  
 - CHO/CAO 16 X and CHV/CAV 16 X  
 - MHO/MAO 16 X and MHV/MAV 16 X

### panel cut-out for bulkhead mounting housings

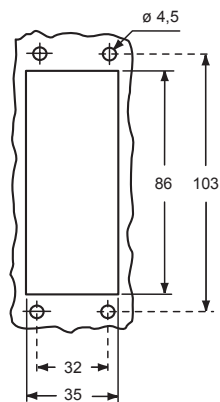

### CHI

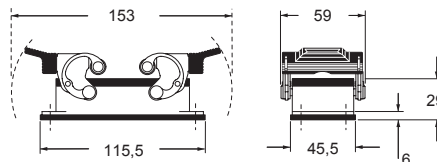

### CHI L

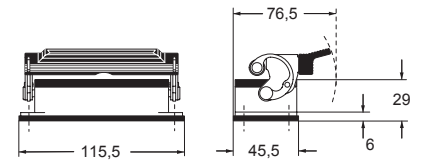

### CHI C

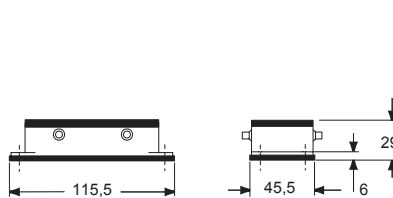

### CHI LS

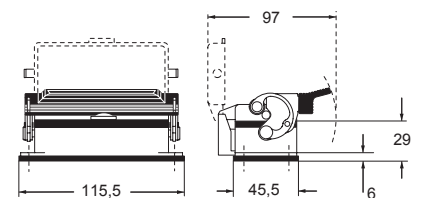

### CHI CS/CP

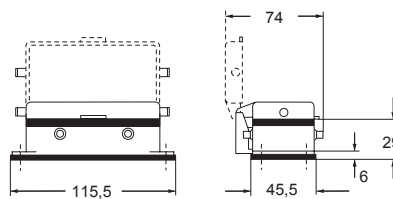

**N.B.:**  
 The enclosures ensure IP66 protection (or IP65 for hinged cover versions) rating when mated and locked with the closing levers. The cover (CS, CP) only ensures mechanical protection, but does not ensure IP65 protection rating.

**CAVUS**® Type 4/4X/12  
 (except enclosures with plastic cover)



# CH - CA and MH - MA C-TYPE standard version

inserts		page:
CD	40 poles + ⊕	70
CDD	72 poles + ⊕	79
CDS	27 poles + ⊕	-
CDSH	27 poles + ⊕	88
CNE	16 poles + ⊕	112
CSE	16 poles + ⊕	-
CSH	16 poles + ⊕	112
CSH S	16 poles + ⊕	124
CCE	16 poles + ⊕	132
CMSH, CMCE	6+2 (aux) poles + ⊕	138 - 139
CSS	16 poles + ⊕	150
CQE	32 poles + ⊕	170
CQEE	40 poles + ⊕	176
CP	6 poles + ⊕	178
CX	6/12, 6/36 and 12/2 poles + ⊕	197 - 199
CX	4/0 and 4/2 poles + ⊕	200 - 201
MIXO	4 modules	232 - 287

## surface mounting housings with 2 levers or 4 pegs

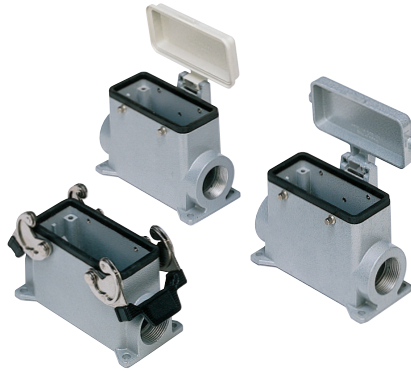

## surface mounting housings with single lever



description	part No.	entry Pg	part No.	entry M	part No.	entry Pg	part No.	entry M
with lever/s	<b>CHP 16</b>	21	<b>MHP 16.25</b>	25	<b>CHP 16 L</b>	21	<b>MHP 16 L25</b>	25
with lever/s	<b>CHP 16.2</b>	21 x 2	<b>MHP 16.225</b>	25 x 2	<b>CHP 16 L2</b>	21 x 2	<b>MHP 16 L225</b>	25 x 2
with levers, high construction *			<b>MAP 16.25</b>	25				
with levers, high construction *			<b>MAP 16.225</b>	25 x 2				
with lever/s, high construction	<b>CAP 16.21</b>	21	<b>MAP 16.32</b>	32	<b>CAP 16 L</b>	21	<b>MAP 16 L32</b>	32
with lever/s, high construction	<b>CAP 16.221</b>	21 x 2	<b>MAP 16.232</b>	32 x 2	<b>CAP 16 L2</b>	21 x 2	<b>MAP 16 L232</b>	32 x 2
with lever/s, high construction	<b>CAP 16.29</b>	29	<b>MAP 16.40</b>	40	<b>CAP 16 L29</b>	29	<b>MAP 16 L40</b>	40
with lever/s, high construction	<b>CAP 16.229</b>	29 x 2	<b>MAP 16.240</b>	40 x 2	<b>CAP 16 L229</b>	29 x 2	<b>MAP 16 L240</b>	40 x 2
with pegs and aluminum cover <sup>1)</sup>	<b>CHP 16 CS</b>	21	<b>MHP 16 CS25</b>	25				
with pegs and aluminum cover <sup>1)</sup>	<b>CHP 16 CS2</b>	21 x 2	<b>MHP 16 CS225</b>	25 x 2				
with pegs and aluminum cover, high construction <sup>1)</sup>	<b>CAP 16 CS</b>	21	<b>MAP 16 CS32</b>	32				
with pegs and aluminum cover, high construction <sup>1)</sup>	<b>CAP 16 CS2</b>	21 x 2	<b>MAP 16 CS232</b>	32 x 2				
with pegs and aluminum cover, high construction <sup>1)</sup>	<b>CAP 16 CS29</b>	29	<b>MAP 16 CS40</b>	40				
with pegs and aluminum cover, high construction <sup>1)</sup>	<b>CAP 16 CS229</b>	29 x 2	<b>MAP 16 CS240</b>	40 x 2				
with pegs and plastic cover <sup>1)</sup>	<b>CHP 16 CP</b>	21	<b>MHP 16 CP25</b>	25				
with pegs and plastic cover <sup>1)</sup>	<b>CHP 16 CP2</b>	21 x 2	<b>MHP 16 CP225</b>	25 x 2				
with pegs and plastic cover, high construction <sup>1)</sup>	<b>CAP 16 CP</b>	21	<b>MAP 16 CP32</b>	32				
with pegs and plastic cover, high construction <sup>1)</sup>	<b>CAP 16 CP2</b>	21 x 2	<b>MAP 16 CP232</b>	32 x 2				
with pegs and plastic cover, high construction <sup>1)</sup>	<b>CAP 16 CP29</b>	29	<b>MAP 16 CP40</b>	40				
with pegs and plastic cover, high construction <sup>1)</sup>	<b>CAP 16 CP229</b>	29 x 2	<b>MAP 16 CP240</b>	40 x 2				
with lever and aluminium cover					<b>CHP 16 LS</b>	21	<b>MHP 16 LS25</b>	25
with lever and aluminium cover					<b>CHP 16 LS2</b>	21 x 2	<b>MHP 16 LS225</b>	25 x 2
with lever and aluminium cover, high construction					<b>CAP 16 LS</b>	21	<b>MAP 16 LS32</b>	32
with lever and aluminium cover, high construction					<b>CAP 16 LS2</b>	21 x 2	<b>MAP 16 LS232</b>	32 x 2
with lever and aluminium cover, high construction					<b>CAP 16 LS29</b>	29	<b>MAP 16 LS40</b>	40
with lever and aluminium cover, high construction					<b>CAP 16 LS229</b>	29 x 2	<b>MAP 16 LS240</b>	40 x 2

\* be used only with a complete cable gland (to be purchased separately)

<sup>1)</sup> may be combined with enclosures:  
 - CHO/CAO 16 X and CHV/CAV 16 X  
 - MHO/MAO 16 X and MHV/MAV 16 X

**N.B.:**  
 The enclosures ensure IP66 protection (or IP65 for hinged cover versions) rating when mated and locked with the closing levers. The cover (CS, CP) only ensures mechanical protection, but does not ensure IP65 protection rating.

### CHP - CAP and MHP - MAP

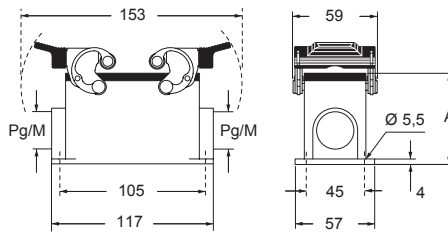

### CHP CS/CP - CAP CS/CP and MHP CS/CP - MAP CS/CP

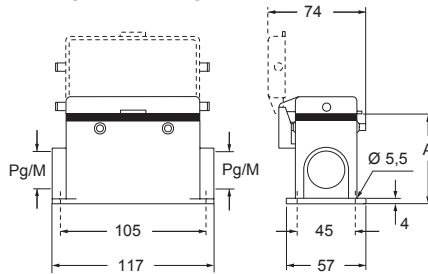

type	A
CHP / MHP	63
CAP / MAP	81
CHP CS / MHP CS	63
CAP CS / MAP CS	81
CHP CP / MHP CP	63
CAP CP / MAP CP	81

### CHP L - CAP L and MHP L - MAP L

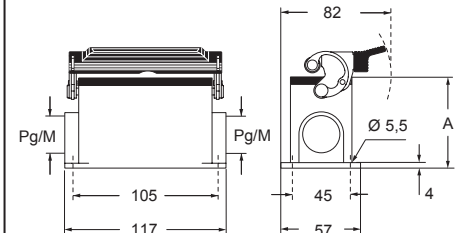

### CHP LS - CAP LS and MHP LS - MAP LS

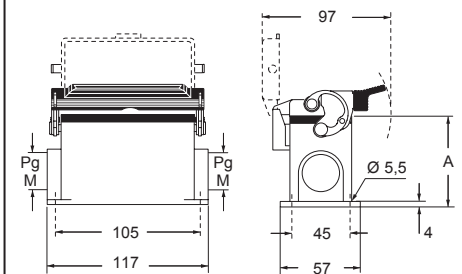

type	A
CHP L / MHP L	63
CAP L / MAP L	81
CHP LS / MHP LS	63
CAP LS / MAP LS	81

**CAVUS** Type 4/4X/12  
 (except enclosures with plastic cover)



# CH - CA - CF and MH - MA - MF C-TYPE standard version

inserts		page:
CD	40 poles + ⊕	70
CDD	72 poles + ⊕	79
CDS	27 poles + ⊕	-
CDSH	27 poles + ⊕	88
CNE	16 poles + ⊕	112
CSE	16 poles + ⊕	-
CSH	16 poles + ⊕	112
CSH S	16 poles + ⊕	124
CCE	16 poles + ⊕	132
CMSH, CMCE	6+2 (aux) poles + ⊕	138 - 139
CSS	16 poles + ⊕	150
CQE	32 poles + ⊕	170
CQEE	40 poles + ⊕	176
CP	6 poles + ⊕	178
CX	6/12, 6/36 and 12/2 poles + ⊕	197 - 199
CX	4/0 and 4/2 poles + ⊕	200 - 201
MIXO	4 modules	232 - 287

## hoods with 4 pegs

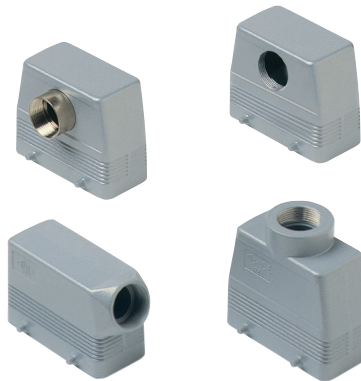

## hoods with 4 pegs M40 cable entry with 20 mm thread length

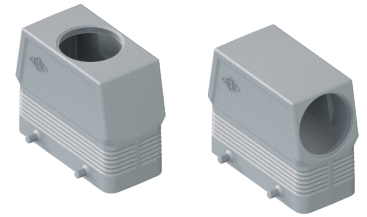

description	part No.	entry Pg	part No	entry M	part No.	entry Pg	part No.	entry M
with pegs, side entry	<b>CHO 16</b>	21	<b>MHO 16.25</b>	25				
with pegs, side entry			<b>MHO 16.32</b>	32				
with pegs, side entry, high construction	<b>CAO 16.21</b>	21	<b>MAO 16.32</b>	32				
with pegs, side entry, high construction	<b>CAO 16.29</b>	29	<b>MAO 16.40</b>	40				
with pegs, side entry, high construction, without adapter *					<b>CFO 16.21</b>	21	<b>MFO 16.32</b>	32
with pegs, side entry, high construction, without adapter *					<b>CFO 16.29</b>	29	<b>MFO 16.40</b>	40
with pegs, top entry	<b>CHV 16</b>	21	<b>MHV 16.25 **</b>	25				
with pegs, top entry			<b>MHV 16.32</b>	32				
with pegs, top entry, high construction	<b>CAV 16.21</b>	21	<b>MAV 16.32</b>	32				
with pegs, top entry, high construction	<b>CAV 16.29</b>	29	<b>MAV 16.40</b>	40				
with pegs, top entry, high construction, without adapter *					<b>CFV 16.21</b>	21	<b>MFV 16.32</b>	32
with pegs, top entry, high construction, without adapter *					<b>CFV 16.29</b>	29	<b>MFV 16.40</b>	40
with pegs, frontal entry, high construction	<b>CAF 16</b>	21	<b>MAF 16.25</b>	25				
with pegs, frontal entry, high construction, without adapter *	<b>CAF 16</b>	21	<b>MAF 16.25</b>	25				

\* enclosure without adapter, threaded on the body, to be used only with a complete cable gland.

\*\* can only be used with a complete cable gland (to be purchased separately).

alternatively, hoods with pegs are coupled with fixed enclosures:

- C-TYPE, IP65/IP66 stainless steel lever, from page 402 to page 410
- C7, IP67 stainless steel lever, page 439
- CV, IP66 stainless steel lever, page 454 and 455

### CHO (CAO) and MHO (MAO)

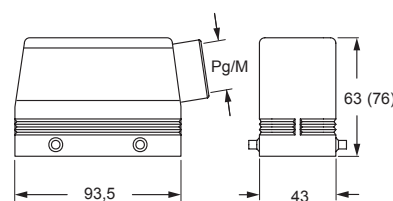

### CFO and MFO

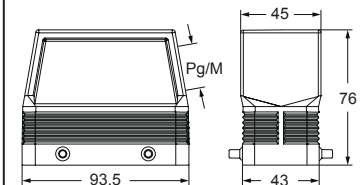

### CHV (CAV) and MHV (MAV)

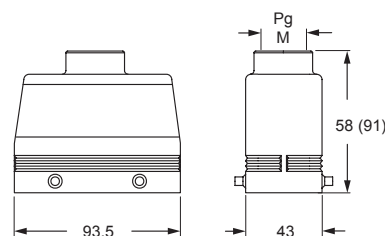

### CFV and MFV

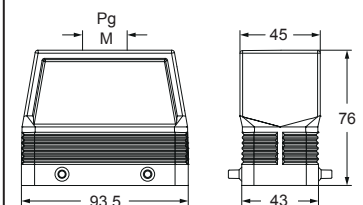

**CALUS** Type 4/4X/12

IP degrees are according to the type of lever and:

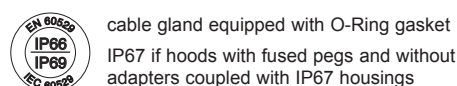
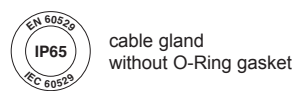

### CAF/CFV and MAF/MFV

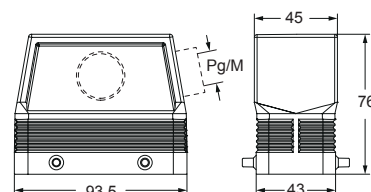



# CH - CA - CF and MH - MA - MF C-TYPE standard version

inserts		page:
CD	40 poles + ⊕	70
CDD	72 poles + ⊕	79
CDS	27 poles + ⊕	-
CDSH	27 poles + ⊕	88
CNE	16 poles + ⊕	112
CSE	16 poles + ⊕	-
CSH	16 poles + ⊕	112
CSH S	16 poles + ⊕	124
CCE	16 poles + ⊕	132
CMSH, CMCE	6+2 (aux) poles + ⊕	138 - 139
CSS	16 poles + ⊕	150
CQE	32 poles + ⊕	170
CQEE	40 poles + ⊕	176
CP	6 poles + ⊕	178
CX	6/12, 6/36 and 12/2 poles + ⊕	197 - 199
CX	4/0 and 4/2 poles + ⊕	200 - 201
MIXO	4 modules	232 - 287

## hoods with 2 pegs



## hoods with 2 pegs

M40 cable entry with 20 mm thread length

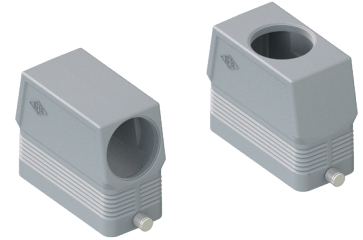

description	part No.	entry Pg	part No	entry M	part No.	entry Pg	part No.	entry M
with pegs, side entry	<b>CHO 16 L</b>	21	<b>MHO 16 L25</b>	25				
with pegs, side entry			<b>MHO 16 L32</b>	32				
with pegs, side entry, high construction	<b>CAO 16 L21</b>	21	<b>MAO 16 L32</b>	32				
with pegs, side entry, high construction	<b>CAO 16 L29</b>	29	<b>MAO 16 L40</b>	40				
with pegs, side entry, high construction, without adapter *					<b>CFO 16 L21</b>	21	<b>MFO 16 L32</b>	32
with pegs, side entry, high construction, without adapter *					<b>CFO 16 L29</b>	29	<b>MFO 16 L40</b>	40
with pegs, top entry	<b>CHV 16 L</b>	21	<b>MHV 16 L25</b>	25				
with pegs, top entry			<b>MHV 16 L32</b>	32				
with pegs, top entry, high construction	<b>CAV 16 L21</b>	21	<b>MAV 16 L32</b>	32				
with pegs, top entry, high construction	<b>CAV 16 L29</b>	29	<b>MAV 16 L40</b>	40				
with pegs, top entry, high construction, without adapter *					<b>CFV 16 L21</b>	21	<b>MFV 16 L32</b>	32
with pegs, top entry, high construction, without adapter *					<b>CFV 16 L29</b>	29	<b>MFV 16 L40</b>	40

\* enclosure without adapter, threaded on the body, to be used only with a complete cable gland.

alternatively, hoods with pegs are coupled with fixed enclosures:

- C-TYPE, IP65/IP66 stainless steel lever, from page 402 to page 410
- C7, IP67 stainless steel lever, page 439
- CV, IP66 stainless steel lever, page 454 and 455

### CHO L (CAO L) and MHO L (MAO L)

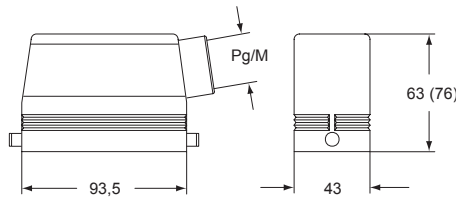

### CFO L and MFO L

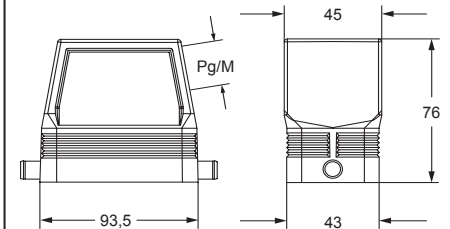

### CHV L (CAV L) and MHV L (MAV L)

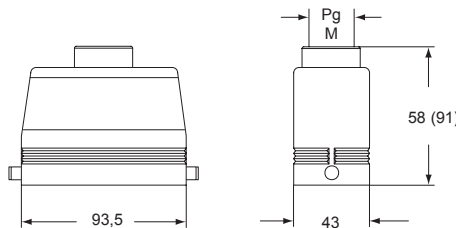

### CFV L and MFV L

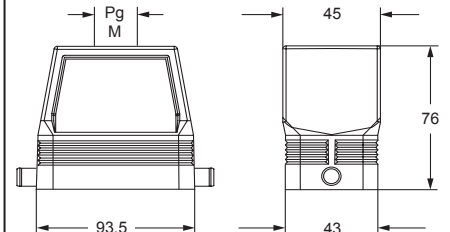

**CAUS** Type 4/4X/12

IP degrees are according to the type of lever and:

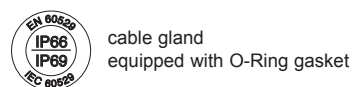
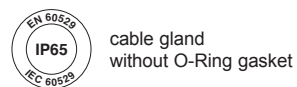

**CA - CF and MA - MF C-TYPE standard version**

inserts		page:
CD	40 poles + ⊕	70
CDD	72 poles + ⊕	79
CDS	27 poles + ⊕	-
CDSH	27 poles + ⊕	88
CNE	16 poles + ⊕	112
CSE	16 poles + ⊕	-
CSH	16 poles + ⊕	112
CSH S	16 poles + ⊕	124
CCE	16 poles + ⊕	132
CMSH, CMCE	6+2 (aux) poles + ⊕	138 - 139
CSS	16 poles + ⊕	150
CQE	32 poles + ⊕	170
CQEE	40 poles + ⊕	176
CP	6 poles + ⊕	178
CX	6/12, 6/36 and 12/2 poles + ⊕	197 - 199
CX	4/0 and 4/2 poles + ⊕	200 - 201
MIXO	4 modules	232 - 287

hoods with double top entry



hoods with double front entry



description	part No.	entry Pg	part No	entry M	part No.	entry Pg	part No.	entry M
with pegs for two levers used with enclosures size "77.27"	<b>CAV 16.216</b>	16 x 2	<b>MAV 16.220</b>	20 x 2				
used with enclosures size "77.27"	<b>CAV 16.221</b>	21 x 2	<b>MAV 16.225</b>	25 x 2				
with pegs for 2 levers, without adapter *								
used with enclosures size "77.27"	<b>CFV 16.216</b>	16 x 2	<b>MFV 16.220</b>	20 x 2				
used with enclosures size "77.27"	<b>CFV 16.221</b>	21 x 2	<b>MFV 16.225</b>	25 x 2				
with pegs for two levers used with enclosures size "77.27"					<b>CAF 16.221</b>	21 x 2	<b>MAF 16.225</b>	25 x 2
with pegs for 2 levers, without adapter *								
used with enclosures size "77.27"					<b>CAF 16.221</b>	21 x 2	<b>MAF 16.225</b>	25 x 2

\* enclosure without adapter, threaded on the body, to be used only with a complete cable gland.

alternatively, hoods with pegs are coupled with fixed enclosures:

- C-TYPE, IP65/IP66 stainless steel lever, from page 402 to page 410
- C7, IP67 stainless steel lever, page 439
- CV, IP66 stainless steel lever, page 454 and 455

CAV/CFV and MAV/MFV

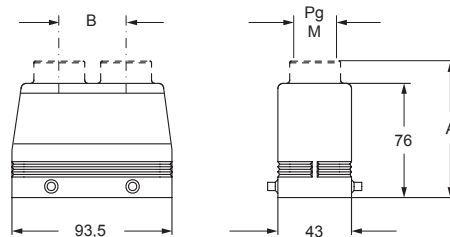

CAF/CFV and MAF/MFV

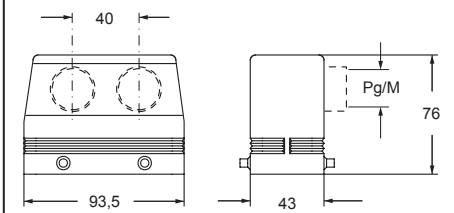

part No.	A	B
<b>CAV 16.216 - MAV 16.220</b>	89 (90,5)	35 (30)
<b>CAV 16.221 - MAV 16.225</b>	90,5 (91)	40
<b>CFV 16.216 - MFV 16.220</b>	-	35 (30)
<b>CFV 16.221 - MFV 16.225</b>	-	40

**CAU<sup>®</sup> US** Type 4/4X/12



IP66 if hoods with fused pegs and without adapters coupled with IP67 housings

# CI and MI C-TYPE standard version

inserts		page:
CD	40 poles + ⊕	70
CDD	72 poles + ⊕	79
CDS	27 poles + ⊕	-
CDSH	27 poles + ⊕	88
CNE	16 poles + ⊕	112
CSE	16 poles + ⊕	-
CSH	16 poles + ⊕	112
CSH S	16 poles + ⊕	124
CCE	16 poles + ⊕	132
CMSH, CMCE	6+2 (aux) poles + ⊕	138 - 139
CSS	16 poles + ⊕	150
CQE	32 poles + ⊕	170
CQEE	40 poles + ⊕	176
CP	6 poles + ⊕	178
CX	6/12, 6/36 and 12/2 poles + ⊕	197 - 199
CX	4/0 and 4/2 poles + ⊕	200 - 201
MIXO	4 modules	232 - 287

**inclined hoods for 2 levers with side entry**



**inclined hoods for 2 levers with top entry**



description	part No.	entry Pg	part No	entry M	part No.	entry Pg	part No.	entry M
used with enclosures size "77.27" with pegs for two levers, side entry	<b>CIO 16.36</b>	36	<b>MIO 16.40</b>	40				
used with enclosures size "77.27" with pegs for two levers, side entry			<b>MIO 16.50</b>	50				
used with enclosures size "77.27" with pegs for two levers, top entry					<b>CIV 16.29</b>	29	<b>MIV 16.40</b>	40

alternatively, hoods with pegs are coupled with fixed enclosures:

- C-TYPE, IP65/IP66 stainless steel lever, from page 402 to page 410
- C7, IP67 stainless steel lever, page 439
- CV, IP66 stainless steel lever, page 454 and 455

**CIO and MIO**

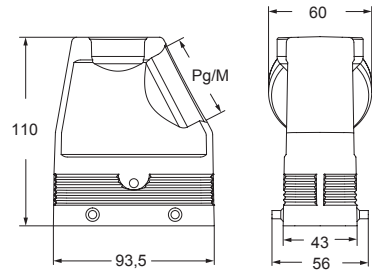

**CIV and MIV**

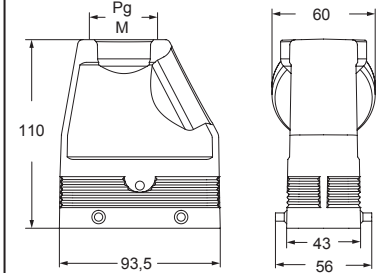

**CAUS**® Type 4/4X/12



according to the type of lever

**CH - CA - CF and MH - MA - MF C-TYPE standard version**

inserts		page:
CD	40 poles + ⊕	70
CDD	72 poles + ⊕	79
CDS	27 poles + ⊕	-
CDSH	27 poles + ⊕	88
CNE	16 poles + ⊕	112
CSE	16 poles + ⊕	-
CSH	16 poles + ⊕	112
CSH S	16 poles + ⊕	124
CCE	16 poles + ⊕	132
CMSH, CMCE	6+2 (aux) poles + ⊕	138 - 139
CSS	16 poles + ⊕	150
CQE	32 poles + ⊕	170
CQEE	40 poles + ⊕	176
CP	6 poles + ⊕	178
CX	6/12, 6/36 and 12/2 poles + ⊕	197 - 199
CX	4/0 and 4/2 poles + ⊕	200 - 201
MIXO	4 modules	232 - 287

hoods with 2 levers



hoods with 2 levers  
M40 cable entry with 20 mm thread length



description	part No.	entry Pg	part No	entry M	part No.	entry M
with levers and gasket, side entry, high construction, without adapter *					<b>MFO 16 G40</b>	40
with levers and gasket, top entry	<b>CHV 16 G</b>	21	<b>MHV 16 G32</b>	32		
with levers and gasket, top entry, high construction	<b>CAV 16 G</b>	21	<b>MAV 16 G25</b>	25		
with levers and gasket, top entry, high construction	<b>CAV 16 G29</b>	29	<b>MAV 16 G32</b>	32		
with levers and gasket, top entry, high construction			<b>MAV 16 G40</b>	40		
with levers and gasket, top entry, high construction, without adapter *	<b>CFV 16 G</b>	21	<b>MFV 16 G25</b>	25		
with levers and gasket, top entry, high construction, without adapter *	<b>CFV 16 G29</b>	29	<b>MFV 16 G32</b>	32		
with levers and gasket, top entry, high construction, without adapter *					<b>MFV 16 G40</b>	40

\* enclosure without adapter, threaded on the body, to be used only with a complete cable gland.

**CHV G (CAV G) and [CFV G],  
MHV G (MAV G) and [MFV G]**

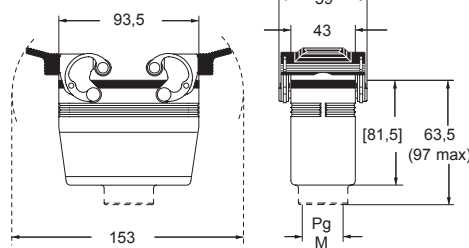

**MFO 16 G40**

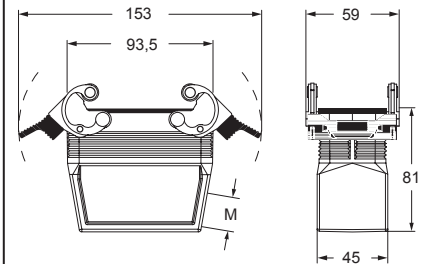

**MFV 16 G40**

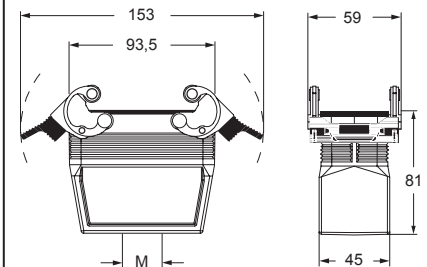

**CALUS** Type 4/4X/12

IP degrees are according to the type of lever and:

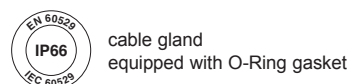
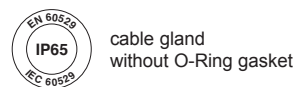

# CH - CA - CF and MH - MA - MF C-TYPE standard version

inserts		page:
CD	40 poles + ⊕	70
CDD	72 poles + ⊕	79
CDS	27 poles + ⊕	-
CDSH	27 poles + ⊕	88
CNE	16 poles + ⊕	112
CSE	16 poles + ⊕	-
CSH	16 poles + ⊕	112
CSH S	16 poles + ⊕	124
CCE	16 poles + ⊕	132
CMSH, CMCE	6+2 (aux) poles + ⊕	138 - 139
CSS	16 poles + ⊕	150
CQE	32 poles + ⊕	170
CQEE	40 poles + ⊕	176
CP	6 poles + ⊕	178
CX	6/12, 6/36 and 12/2 poles + ⊕	197 - 199
CX	4/0 and 4/2 poles + ⊕	200 - 201
MIXO	4 modules	232 - 287

## hoods with 1 lever



## hoods with 1 lever

M40 cable entry with 20 mm thread length



description	part No.	entry Pg	part No.	entry M	part No.	entry M
with lever and gasket, side entry, high construction, without adapter *					<b>MFO 16 LG40</b>	40
with lever and gasket, top entry	<b>CHV 16 LG</b>	21	<b>MHV 16 LG32</b>	32		
with lever and gasket, top entry, high construction	<b>CAV 16 LG21</b>	21	<b>MAV 16 LG25</b>	25		
with lever and gasket, top entry, high construction	<b>CAV 16 LG29</b>	29	<b>MAV 16 LG32</b>	32		
with lever and gasket, top entry, high construction			<b>MAV 16 LG40</b>	40		
with lever and gasket, top entry, high construction, without adapter *	<b>CFV 16 LG21</b>	21	<b>MFV 16 LG25</b>	25		
with lever and gasket, top entry, high construction, without adapter *	<b>CFV 16 LG29</b>	29	<b>MFV 16 LG32</b>	32		
with lever and gasket, top entry, high construction, without adapter *					<b>MFV 16 LG40</b>	40

\* enclosure without adapter, threaded on the body, to be used only with a complete cable gland.

### CHV LG (CAV LG) and [CFV LG], MHV LG (MAV LG) and [MFV LG]

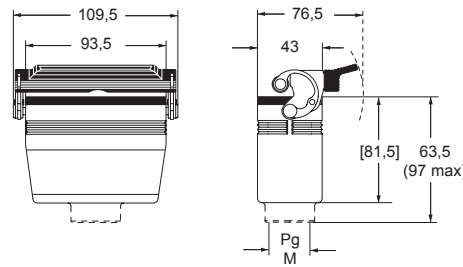

### MFO 10 LG40

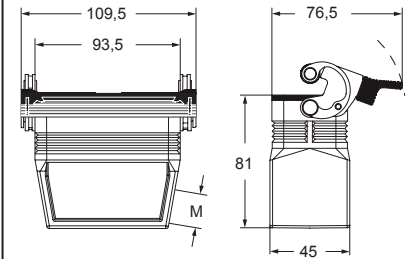

### MFV 10 LG40

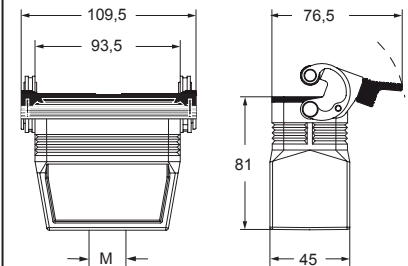

**CRUS** Type 4/4X/12

IP degrees are according to the type of lever and:

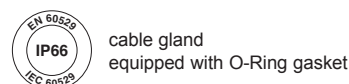
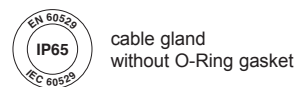

# CH - CA and MH - MA C-TYPE standard version

inserts		page:
CD	40 poles + ⊕	70
CDD	72 poles + ⊕	79
CDS	27 poles + ⊕	-
CDSH	27 poles + ⊕	88
CNE	16 poles + ⊕	112
CSE	16 poles + ⊕	-
CSH	16 poles + ⊕	112
CSH S	16 poles + ⊕	124
CCE	16 poles + ⊕	132
CMSH, CMCE	6+2 (aux) poles + ⊕	138 - 139
CSS	16 poles + ⊕	150
CQE	32 poles + ⊕	170
CQEE	40 poles + ⊕	176
CP	6 poles + ⊕	178
CX	6/12, 6/36 and 12/2 poles + ⊕	197 - 199
CX	4/0 and 4/2 poles + ⊕	200 - 201
MIXO	4 modules	232 - 287

## hoods with 2 levers

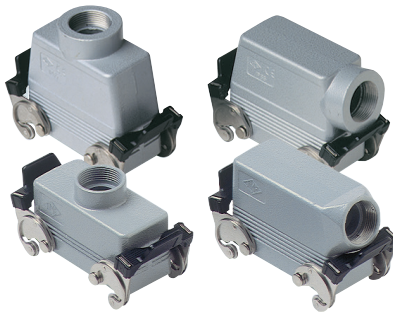

## covers



description	part No.	entry Pg	part No	entry M	part No. (with eyelet)	part No. (with loop)
with levers, side entry <sup>1)</sup>	<b>CHO 16 X</b>	21	<b>MHO 16 X25</b>	25		
with levers, side entry <sup>1)</sup>			<b>MHO 16 X32</b>	32		
with levers, side entry, high construction <sup>1)</sup>	<b>CAO 16 X</b>	21	<b>MAO 16 X32</b>	32		
with levers, side entry, high construction <sup>1)</sup>	<b>CAO 16 X29</b>	29	<b>MAO 16 X40</b>	40		
with levers, top entry <sup>1)</sup>	<b>CHV 16 X</b>	21	<b>MHV 16 X25</b>	25		
with levers, top entry <sup>1)</sup>			<b>MHV 16 X32</b>	32		
with levers, top entry, high construction <sup>1)</sup>	<b>CAV 16 X</b>	21	<b>MAV 16 X32</b>	32		
with levers, top entry, high construction <sup>1)</sup>	<b>CAV 16 X29</b>	29	<b>MAV 16 X40</b>	40		
with 4 pegs (for enclosures with 2 levers with gasket)					<b>CHC 16</b>	<b>CHC 16 S</b>
with 4 pegs and gasket (for enclosures with 2 levers) <sup>2)</sup>						<b>CHC 16 C</b>
with 2 pegs (for enclosures with 1 lever with gasket)					<b>CHC 16 L</b>	<b>CHC 16 SL</b>
with 2 levers (for hoods with 4 pegs)						<b>CHC 16 G</b>
with 1 lever (for hoods with 2 pegs)						<b>CHC 16 LG</b>

<sup>1)</sup> may be combined with enclosures:

- CHI/CHP/CAP 16 CS/CP/C
- MHP/MAP 16 CS/CP

<sup>2)</sup> may be combined with enclosures:

- CHO/CAO 16 X and CHV/CAV 16 X
- MHO/MAO 16 X and MHV/MAV 16 X

### CHO X (CAO X) and MHO X (MAO X)

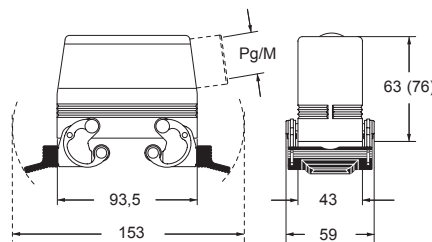

### CHV X (CAV X) and MHV X (MAV X)

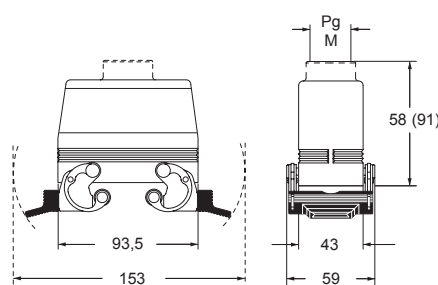

### CHC (S)

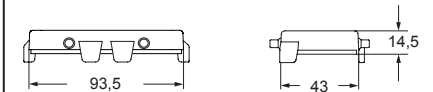

### CHC C



### CHC L (SL)

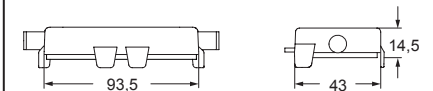

### CHC G

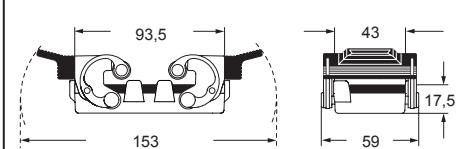

### CHC LG

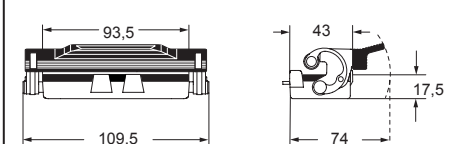

For fixing on housings

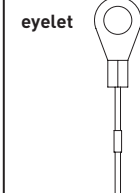

For fixing on hoods

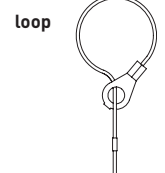

dust protection cover  
**CHCP 16**  
(page 696)



**CAIUS**® Type  
4/4X/12





# CAC C-TYPE standard version

inserts		page:
CD	40 poles + ⊕	70
CDD	72 poles + ⊕	79
CDS	27 poles + ⊕	-
CDSH	27 poles + ⊕	88
CNE	16 poles + ⊕	112
CSE	16 poles + ⊕	-
CSH	16 poles + ⊕	112
CSH S	16 poles + ⊕	124
CCE	16 poles + ⊕	132
CMSH, CMCE	6+2 (aux) poles + ⊕	138 - 139
CSS	16 poles + ⊕	150
CQE	32 poles + ⊕	170
CQEE	40 poles + ⊕	176
CP	6 poles + ⊕	178
CX	6/12, 6/36 and 12/2 poles + ⊕	197 - 199
CX	4/0 and 4/2 poles + ⊕	200 - 201
MIXO	4 modules	232 - 287

## hoods without entry, to be drilled



## hoods without entry, to be drilled



description	part No. with 4 pegs	part No. with 2 pegs
-------------	-------------------------	-------------------------

with pegs, high construction

**CAC 16**

**CAC 16 L**

alternatively, hoods with pegs are coupled with fixed enclosures:

- C-TYPE, IP65/IP66 stainless steel lever, from page 402 to page 410
- C7, IP67 stainless steel lever, page 439
- CV, IP66 stainless steel lever, page 454 and 455

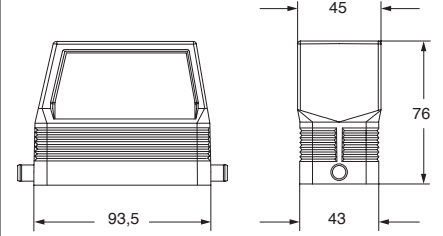
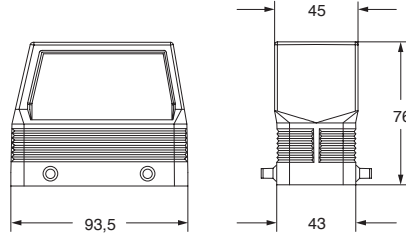

**CAI<sup>®</sup> US** Type 4/4X/12



# CH C-TYPE standard version

inserts		page:
CD	64 poles + ⊕	72
CDD	108 poles + ⊕	81
CDS	42 poles + ⊕	-
CDSH	42 poles + ⊕	89
CNE	24 poles + ⊕	113
CSE	24 poles + ⊕	-
CSH	24 poles + ⊕	113
CSH S	24 poles + ⊕	125
CCE	24 poles + ⊕	133
CMSH	10+2 (aux) poles + ⊕	140
CMCE	10+2 (aux) poles + ⊕	141
CSS	24 poles + ⊕	151
CT, CTS (10A) *)	64 poles + ⊕	157
CT, CTSE (16A) *)	24 poles + ⊕	163
CQE	46 poles + ⊕	171
CQEE	64 poles + ⊕	177
CX	4/8 and 6/6 poles + ⊕	204 and 206
MIXO	6 modules	232 - 287

\*) can be used only in bulkhead mounting housings

## bulkhead mounting housings with 2 levers or 4 pegs



## bulkhead mounting housings with single lever



description	part No.	part No.
with one or two levers	<b>CHI 24</b>	<b>CHI 24 L</b>
with pegs <sup>1)</sup>	<b>CHI 24 C</b>	
with pegs and aluminum cover <sup>1)</sup>	<b>CHI 24 CS</b>	
with pegs and plastic cover <sup>1)</sup>	<b>CHI 24 CP</b>	
with lever and aluminum cover		<b>CHI 24 LS</b>

<sup>1)</sup> may be combined with enclosures:  
 - CHO/CAO 24 X and CHV/CAV 24 X  
 - MHO/MAO 24 X and MHV/MAV 24 X

panel cut-out for bulkhead mounting housings

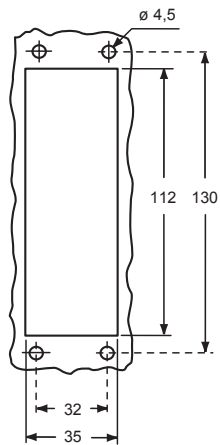

### CHI

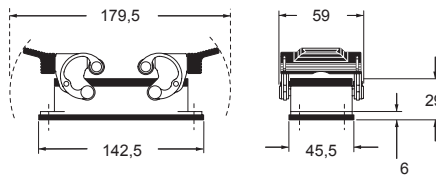

### CHI L

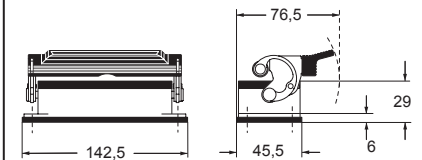

### CHI C

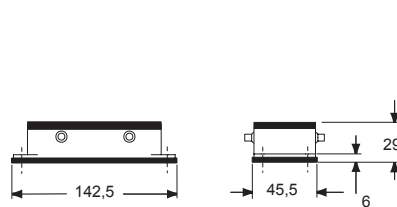

### CHI LS

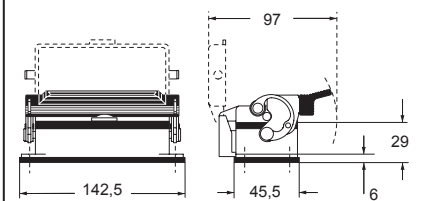

### CHI CS/CP

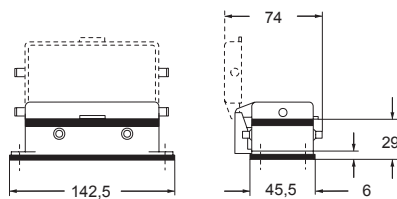

**N.B.:**  
 The enclosures ensure IP66 protection (or IP65 for hinged cover versions) rating when mated and locked with the closing levers. The cover (CS, CP) only ensures mechanical protection, but does not ensure IP65 protection rating.

**CAVUS**® Type 4/4X/12  
 (except enclosures with plastic cover)



# CH - CA and MH - MA C-TYPE standard version

inserts		page:
CD	64 poles + ⊕	72
CDD	108 poles + ⊕	81
CDS	42 poles + ⊕	-
CDSH	42 poles + ⊕	89
CNE	24 poles + ⊕	113
CSE	24 poles + ⊕	-
CSH	24 poles + ⊕	113
CSH S	24 poles + ⊕	125
CCE	24 poles + ⊕	133
CMSH	10+2 (aux) poles + ⊕	140
CMCE	10+2 (aux) poles + ⊕	141
CSS	24 poles + ⊕	151
CQE	46 poles + ⊕	171
CQEE	64 poles + ⊕	177
CX	4/8 and 6/6 poles + ⊕	204 and 206
MIXO	6 modules	232 - 287

## surface mounting housings with 2 levers or 4 pegs



## surface mounting housings with single lever

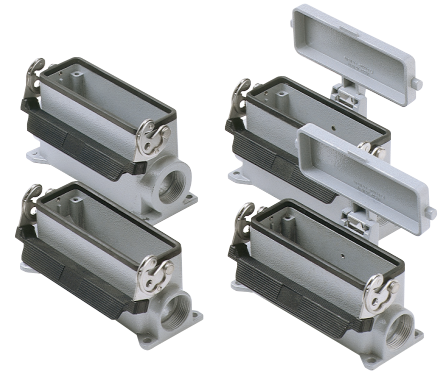

description	part No.	entry Pg	part No	entry M	part No.	entry Pg	part No.	entry M
with lever/s	<b>CHP 24</b>	21	<b>MHP 24.25</b>	25	<b>CHP 24 L</b>	21	<b>MHP 24 L25</b>	25
with lever/s	<b>CHP 24.2</b>	21 x 2	<b>MHP 24.225</b>	25 x 2	<b>CHP 24 L2</b>	21 x 2	<b>MHP 24 L225</b>	25 x 2
with levers, high construction *			<b>MAP 24.25</b>	25				
with levers, high construction *			<b>MAP 24.225</b>	25 x 2				
with lever/s, high construction	<b>CAP 24.21</b>	21	<b>MAP 24.32</b>	32	<b>CAP 24 L</b>	21	<b>MAP 24 L32</b>	32
with lever/s, high construction	<b>CAP 24.221</b>	21 x 2	<b>MAP 24.232</b>	32 x 2	<b>CAP 24 L2</b>	21 x 2	<b>MAP 24 L232</b>	32 x 2
with lever/s, high construction	<b>CAP 24.29</b>	29	<b>MAP 24.40</b>	40	<b>CAP 24 L29</b>	29	<b>MAP 24 L40</b>	40
with lever/s, high construction	<b>CAP 24.229</b>	29 x 2	<b>MAP 24.240</b>	40 x 2	<b>CAP 24 L229</b>	29 x 2	<b>MAP 24 L240</b>	40 x 2
with pegs and aluminum cover 1)	<b>CHP 24 CS</b>	21	<b>MHP 24 CS25</b>	25				
with pegs and aluminum cover 1)	<b>CHP 24 CS2</b>	21 x 2	<b>MHP 24 CS225</b>	25 x 2				
with pegs and aluminum cover, high construction 1)	<b>CAP 24 CS</b>	21	<b>MAP 24 CS32</b>	32				
with pegs and aluminum cover, high construction 1)	<b>CAP 24 CS2</b>	21 x 2	<b>MAP 24 CS232</b>	32 x 2				
with pegs and aluminum cover, high construction 1)	<b>CAP 24 CS29</b>	29	<b>MAP 24 CS40</b>	40				
with pegs and aluminum cover, high construction 1)	<b>CAP 24 CS229</b>	29 x 2	<b>MAP 24 CS240</b>	40 x 2				
with pegs and plastic cover 1)	<b>CHP 24 CP</b>	21	<b>MHP 24 CP25</b>	25				
with pegs and plastic cover 1)	<b>CHP 24 CP2</b>	21 x 2	<b>MHP 24 CP225</b>	25 x 2				
with pegs and plastic cover, high construction 1)	<b>CAP 24 CP</b>	21	<b>MAP 24 CP32</b>	32				
with pegs and plastic cover, high construction 1)	<b>CAP 24 CP2</b>	21 x 2	<b>MAP 24 CP232</b>	32 x 2				
with pegs and plastic cover, high construction 1)	<b>CAP 24 CP29</b>	29	<b>MAP 24 CP40</b>	40				
with pegs and plastic cover, high construction 1)	<b>CAP 24 CP229</b>	29 x 2	<b>MAP 24 CP240</b>	40 x 2				
with lever and aluminium cover	<b>CHP 24 LS</b>	21	<b>MHP 24 LS25</b>	25				
with lever and aluminium cover	<b>CHP 24 LS2</b>	21 x 2	<b>MHP 24 LS225</b>	25 x 2				
with lever and aluminium cover, high construction	<b>CAP 24 LS</b>	21	<b>MAP 24 LS32</b>	32				
with lever and aluminium cover, high construction	<b>CAP 24 LS2</b>	21 x 2	<b>MAP 24 LS232</b>	32 x 2				
with lever and aluminium cover, high construction	<b>CAP 24 LS29</b>	29	<b>MAP 24 LS40</b>	40				
with lever and aluminium cover, high construction	<b>CAP 24 LS229</b>	29 x 2	<b>MAP 24 LS240</b>	40 x 2				

\* to be used only with a complete cable gland (to be purchased separately)

1) may be combined with enclosures:  
 - CHO/CAO 24 X and CHV/CAV 24 X  
 - MHO/MAO 24 X and MHV/MAV 24 X

**N.B.:**  
 The enclosures ensure IP66 protection (or IP65 for hinged cover versions) rating when mated and locked with the closing levers. The cover (CS, CP) only ensures mechanical protection, but does not ensure IP65 protection rating.

### CHP - CAP and MHP - MAP

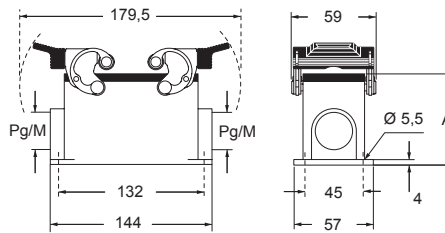

### CHP CS/CP - CAP CS/CP and MHP CS/CP - MAP CS/CP

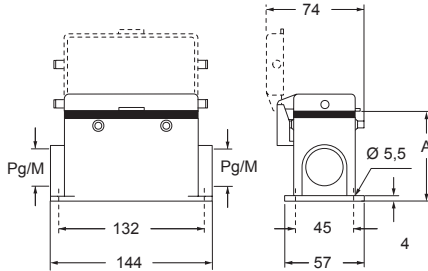

type	A
CHP / MHP	63
CAP / MAP	81
CHP CS / MHP CS	63
CAP CS / MAP CS	81
CHP CP / MHP CP	63
CAP CP / MAP CP	81

### CHP L - CAP L and MHP L - MAP L

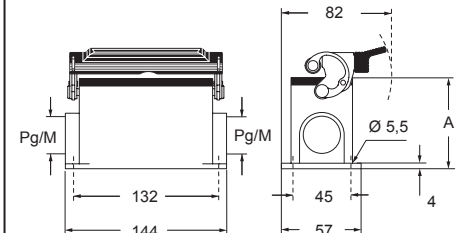

### CHP LS - CAP LS and MHP LS - MAP LS

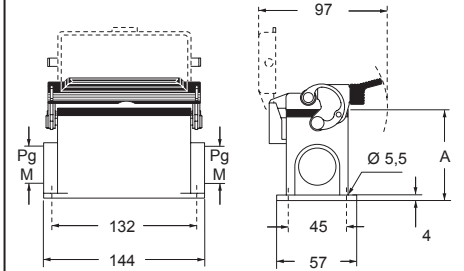

type	A
CHP L / MHP L	63
CAP L / MAP L	81
CHP LS / MHP LS	63
CAP LS / MAP LS	81

**CAVUS**® Type 4/4X/12  
 (except enclosures with plastic cover)



# CH - CA - CF and MH - MA - MF C-TYPE standard version

inserts		page:
CD	64 poles + ⊕	72
CDD	108 poles + ⊕	81
CDS	42 poles + ⊕	-
CDSH	42 poles + ⊕	89
CNE	24 poles + ⊕	113
CSE	24 poles + ⊕	-
CSH	24 poles + ⊕	113
CSH S	24 poles + ⊕	125
CCE	24 poles + ⊕	133
CMSH	10+2 (aux) poles + ⊕	140
CMCE	10+2 (aux) poles + ⊕	141
CSS	24 poles + ⊕	151
CQE	46 poles + ⊕	171
CQEE	64 poles + ⊕	177
CX	4/8 and 6/6 poles + ⊕	204 and 206
MIXO	6 modules	232 - 287

## hoods with 4 pegs



## hoods with 4 pegs M40 cable entry with 20 mm thread length

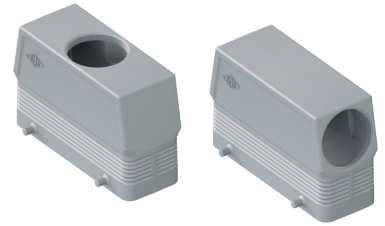

description	part No.	entry Pg	part No	entry M	part No.	entry Pg	part No.	entry M
with pegs, side entry	<b>CHO 24</b>	21	<b>MHO 24.25</b>	25				
with pegs, side entry			<b>MHO 24.32</b>	32				
with pegs, side entry, high construction	<b>CAO 24.21</b>	21	<b>MAO 24.32</b>	32				
with pegs, side entry, high construction	<b>CAO 24.29</b>	29	<b>MAO 24.40</b>	40				
with pegs, side entry, high construction, without adapter *					<b>CFO 24.21</b>	21	<b>MFO 24.32</b>	32
with pegs, side entry, high construction, without adapter *					<b>CFO 24.29</b>	29	<b>MFO 24.40</b>	40
with pegs, top entry	<b>CHV 24</b>	21	<b>MHV 24.25 **</b>	25				
with pegs, top entry			<b>MHV 24.32</b>	32				
with pegs, top entry	<b>CHV 24.29</b>	29	<b>MHV 24.40</b>	40				
with pegs, top entry, high construction	<b>CAV 24.21</b>	21	<b>MAV 24.32</b>	32				
with pegs, top entry, high construction	<b>CAV 24.29</b>	29	<b>MAV 24.40</b>	40				
with pegs, top entry, high construction, without adapter *					<b>CFV 24.21</b>	21	<b>MFV 24.32</b>	32
with pegs, top entry, high construction, without adapter *					<b>CFV 24.29</b>	29	<b>MFV 24.40</b>	40
with pegs, frontal entry, high construction	<b>CAF 24.21</b>	21	<b>MAF 24.25</b>	25				
with pegs, frontal entry, high construction	<b>CAF 24.29</b>	29	<b>MAF 24.32</b>	32				
with pegs, frontal entry, high construction, without adapter *	<b>CFF 24.21</b>	21	<b>MFF 24.25</b>	25				
with pegs, frontal entry, high construction, without adapter *	<b>CFF 24.29</b>	29	<b>MFF 24.32</b>	32				

\* enclosure without adapter, threaded on the body, to be used only with a complete cable gland.

\*\* can only be used with a complete cable gland (to be purchased separately).

alternatively, hoods with pegs are coupled with fixed enclosures:

- C-TYPE, IP65/IP66 stainless steel lever, from page 412 to page 422
- C7, IP67 stainless steel lever, page 441
- CV, IP66 stainless steel lever, page 460 and 461

### CHO (CAO) and MHO (MAO)

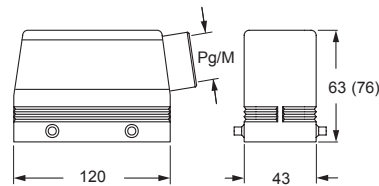

### CFO and MFO

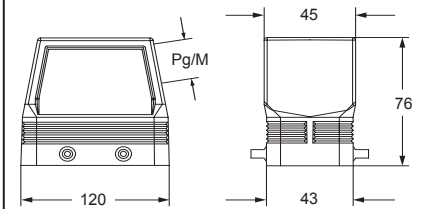

### CHV (CAV) and MHV (MAV)

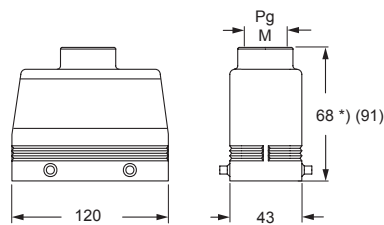

### CFV and MFV

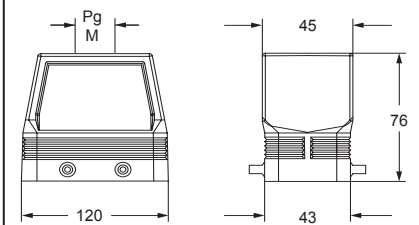

\*) 69,5 for Pg 29 - M 40 versions

### CAF/CFF and MAF/MFF

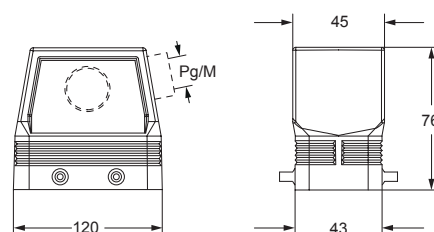

**CAIUS** Type 4/4X/12

IP degrees are according to the type of lever and:

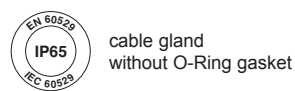

cable gland without O-Ring gasket



cable gland equipped with O-Ring gasket  
IP67 if hoods with fused pegs and without adapters coupled with IP67 housings

# CH - CA - CF and MH - MA - MF C-TYPE standard version

inserts		page:
CD	64 poles + ⊕	72
CDD	108 poles + ⊕	81
CDS	42 poles + ⊕	-
CDSH	42 poles + ⊕	89
CNE	24 poles + ⊕	113
CSE	24 poles + ⊕	-
CSH	24 poles + ⊕	113
CSH S	24 poles + ⊕	125
CCE	24 poles + ⊕	133
CMSH	10+2 (aux) poles + ⊕	140
CMCE	10+2 (aux) poles + ⊕	141
CSS	24 poles + ⊕	151
CQE	46 poles + ⊕	171
CQEE	64 poles + ⊕	177
CX	4/8 and 6/6 poles + ⊕	204 and 206
MIXO	6 modules	232 - 287

## hoods with 2 pegs



## hoods with 2 pegs

M40 cable entry with 20 mm thread length

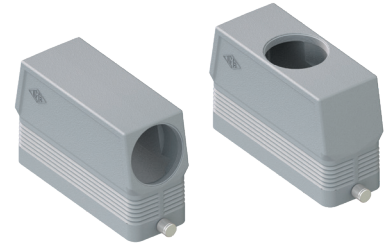

description	part No.	entry Pg	part No	entry M	part No.	entry Pg	part No.	entry M
with pegs, side entry	<b>CHO 24 L</b>	21	<b>MHO 24 L25</b>	25				
with pegs, side entry			<b>MHO 24 L32</b>	32				
with pegs, side entry, high construction	<b>CAO 24 L21</b>	21	<b>MAO 24 L32</b>	32				
with pegs, side entry, high construction	<b>CAO 24 L29</b>	29	<b>MAO 24 L40</b>	40				
with pegs, side entry, high construction, without adapter *					<b>CFO 24 L21</b>	21	<b>MFO 24 L32</b>	32
with pegs, side entry, high construction, without adapter *					<b>CFO 24 L29</b>	29	<b>MFO 24 L40</b>	40
with pegs, top entry	<b>CHV 24 L</b>	21	<b>MHV 24 L25</b>	25				
with pegs, top entry			<b>MHV 24 L32</b>	32				
with pegs, top entry	<b>CHV 24 L29</b>	29	<b>MHV 24 L40</b>	40				
with pegs, top entry, high construction	<b>CAV 24 L21</b>	21	<b>MAV 24 L32</b>	32				
with pegs, top entry, high construction	<b>CAV 24 L29</b>	29	<b>MAV 24 L40</b>	40				
with pegs, top entry, high construction, without adapter *					<b>CFV 24 L21</b>	21	<b>MFV 24 L32</b>	32
with pegs, top entry, high construction, without adapter *					<b>CFV 24 L29</b>	29	<b>MFV 24 L40</b>	40

\* enclosure without adapter, threaded on the body, to be used only with a complete cable gland.

alternatively, hoods with pegs are coupled with fixed enclosures:

- C-TYPE, IP65/IP66 stainless steel lever, from page 412 to page 422
- C7, IP67 stainless steel lever, page 441
- CV, IP66 stainless steel lever, page 460 and 461

### CHO L (CAO L) and MHO L (MAO L)

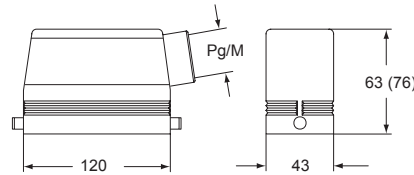

### CHV L (CAV L) and MHV L (MAV L)

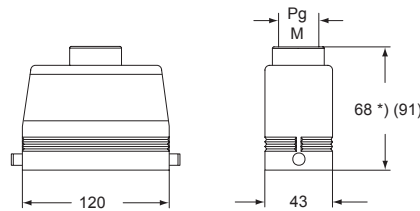

\*) 69,5 for Pg 29 - M 40 versions

### CFO L and MFO L

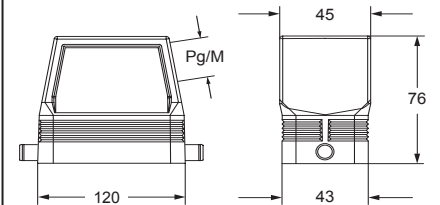

### CFV L and MFV L

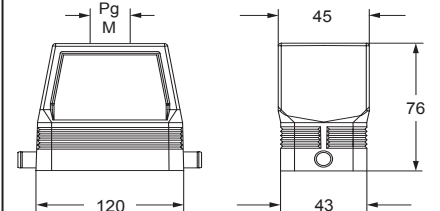

**CALUS** Type 4/4X/12

IP degrees are according to the type of lever and:

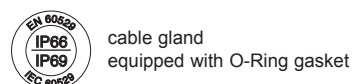
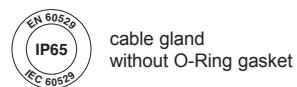

**CA - CF and MA - MF C-TYPE standard version**

inserts		page:
CD	64 poles + ⊕	72
CDD	108 poles + ⊕	81
CDS	42 poles + ⊕	-
CDSH	42 poles + ⊕	89
CNE	24 poles + ⊕	113
CSE	24 poles + ⊕	-
CSH	24 poles + ⊕	113
CSH S	24 poles + ⊕	125
CCE	24 poles + ⊕	133
CMSH	10+2 (aux) poles + ⊕	140
CMCE	10+2 (aux) poles + ⊕	141
CSS	24 poles + ⊕	151
CQE	46 poles + ⊕	171
CQEE	64 poles + ⊕	177
CX	4/8 and 6/6 poles + ⊕	204 and 206
MIXO	6 modules	232 - 287

**hoods with double top entry and 4 pegs**



**hoods with double front entry and 4 pegs**



description	part No.	entry Pg	part No	entry M	part No.	entry Pg	part No.	entry M
with pegs for two levers used with enclosures size "104.27"	<b>CAV 24.221</b>	21 x 2	<b>MAV 24.232</b>	32 x 2				
used with enclosures size "104.27"	<b>CAV 24.229</b>	29 x 2						
with pegs for 2 levers, without adapter * used with enclosures size "104.27"	<b>CFV 24.221</b>	21 x 2	<b>MFV 24.232</b>	32 x 2				
with pegs for two levers used with enclosures size "104.27"					<b>CAF 24.221</b>	21 x 2	<b>MAF 24.225</b>	25 x 2
with pegs for 2 lever, without adapter * used with enclosures size "104.27"					<b>CFF 24.221</b>	21 x 2	<b>MFF 24.225</b>	25 x 2

\* enclosure without adapter, threaded on the body, to be used only with a complete cable gland.

**CAV/CFV and MAV/MFV**

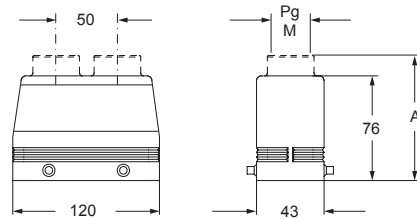

part No.	A
<b>CAV 24.221 - MAV 24.232</b>	90,5 (91)
<b>CAV 24.229</b>	90,5
<b>CFV 24.221 - MFV 24.232</b>	-

**CAF/CFF and MAF/MFF**

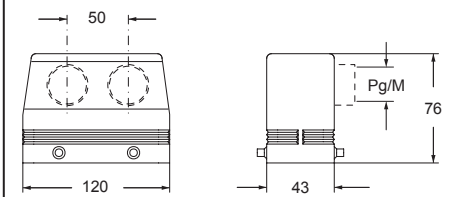

alternatively, hoods with pegs are coupled with fixed enclosures:

- C-TYPE, IP65/IP66 stainless steel lever, from page 412 to page 422
- C7, IP67 stainless steel lever, page 441
- CV, IP66 stainless steel lever, page 460 and 461

**CAU<sup>®</sup>US** Type 4/4X/12



IP67 if hoods with fused pegs and without adapters coupled with IP67 housings

C-TYPE



# CI and MI C-TYPE standard version

inserts		page:
CD	64 poles + ⊕	72
CDD	108 poles + ⊕	81
CDS	42 poles + ⊕	-
CDSH	42 poles + ⊕	89
CNE	24 poles + ⊕	113
CSE	24 poles + ⊕	-
CSH	24 poles + ⊕	113
CSH S	24 poles + ⊕	125
CCE	24 poles + ⊕	133
CMSH	10+2 (aux) poles + ⊕	140
CMCE	10+2 (aux) poles + ⊕	141
CSS	24 poles + ⊕	151
CQE	46 poles + ⊕	171
CQEE	64 poles + ⊕	177
CX	4/8 and 6/6 poles + ⊕	204 and 206
MIXO	6 modules	232 - 287

## inclined hoods for 2 levers with side entry



## inclined hoods for 2 levers with top entry



description	part No.	entry Pg	part No.	entry M	part No.	entry Pg	part No.	entry M
used with enclosures size "104.27" with pegs for two levers, side entry	<b>CIO 24.36</b>	36	<b>MIO 24.40</b>	40				
with pegs for two levers, side entry			<b>MIO 24.50</b>	50				
used with enclosures size "104.27" with pegs for two levers, top entry	<b>CIV 24.36</b>	36			<b>MIV 24.40</b>	40		
with pegs for two levers, top entry					<b>MIV 24.50</b>	50		

alternatively, hoods with pegs are coupled with fixed enclosures:

- C-TYPE, IP65/IP66 stainless steel lever, from page 412 to page 422
- C7, IP67 stainless steel lever, page 441
- CV, IP66 stainless steel lever, page 460 and 461

### CIO and MIO

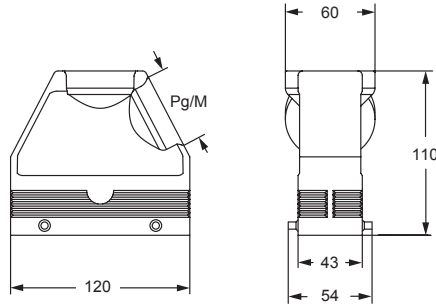

### CIV and MIV

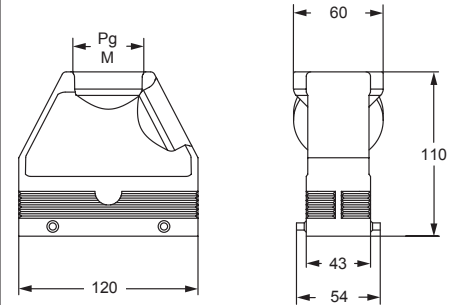

**CAUS**® Type 4/4X/12



according to the type of lever

**CQ and MQ C-TYPE standard version**

inserts		page:
CD	64 poles + ⊕	72
CDD	108 poles + ⊕	81
CDS	42 poles + ⊕	-
CDSH	42 poles + ⊕	89
CNE	24 poles + ⊕	113
CSE	24 poles + ⊕	-
CSH	24 poles + ⊕	113
CSH S	24 poles + ⊕	125
CCE	24 poles + ⊕	133
CMSH	10+2 (aux) poles + ⊕	140
CMCE	10+2 (aux) poles + ⊕	141
CSS	24 poles + ⊕	151
CQE	46 poles + ⊕	171
CQEE	64 poles + ⊕	177
CX	4/8 and 6/6 poles + ⊕	204 and 206
MIXO	6 modules	232 - 287

enlarged hoods,  
side or top entry with 4 pegs

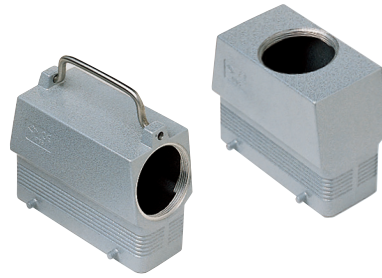

description	part No.	entry Pg	part No	entry M
used with enclosures size "104.27"				
with pegs for two levers, side entry, without adapter *	<b>CQO 24</b>	36	<b>MQO 24.40</b>	40
with pegs for two levers, top entry, without adapter *	<b>CQV 24</b>	36	<b>MQV 24.40</b>	40

\* enclosure without adapter, threaded on the body, to be used only with a complete cable gland.

alternatively, hoods with pegs are coupled with fixed enclosures:

- C-TYPE, IP65/IP66 stainless steel lever, from page 412 to page 422
- C7, IP67 stainless steel lever, page 441
- CV, IP66 stainless steel lever, page 460 and 461

**CQO and MQO**

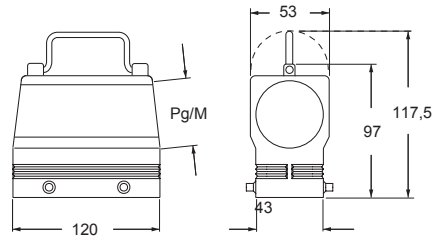

**CQV and MQV**

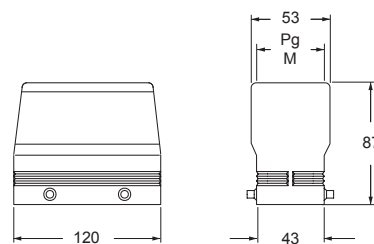

C-TYPE

**CAUS**® Type 4/4X/12



according to the type of lever  
IP67 if hoods with fused pegs and without adapters coupled with IP67 housings

# CH - CA - CF and MH - MA - MF C-TYPE standard version

inserts		page:
CD	64 poles + ⊕	72
CDD	108 poles + ⊕	81
CDS	42 poles + ⊕	-
CDSH	42 poles + ⊕	89
CNE	24 poles + ⊕	113
CSE	24 poles + ⊕	-
CSH	24 poles + ⊕	113
CSH S	24 poles + ⊕	125
CCE	24 poles + ⊕	133
CMSH	10+2 (aux) poles + ⊕	140
CMCE	10+2 (aux) poles + ⊕	141
CSS	24 poles + ⊕	151
CQE	46 poles + ⊕	171
CQEE	64 poles + ⊕	177
CX	4/8 and 6/6 poles + ⊕	204 and 206
MIXO	6 modules	232 - 287

## hoods with 2 levers



## hoods with 2 levers M40 cable entry with 20 mm thread length



description	part No.	entry Pg	part No	entry M	part No.	entry M
with levers and gasket, side entry, high construction, without adapter *					<b>MFO 24 G40</b>	40
with levers and gasket, top entry	<b>CHV 24 G</b>	21	<b>MHV 24 G32</b>	32		
with levers and gasket, top entry, high construction	<b>CAV 24 G</b>	21	<b>MAV 24 G25</b>	25		
with levers and gasket, top entry, high construction	<b>CAV 24 G29</b>	29	<b>MAV 24 G32</b>	32		
with levers and gasket, top entry, high construction			<b>MAV 24 G40</b>	40		
with levers and gasket, top entry, high construction, without adapter *	<b>CFV 24 G</b>	21	<b>MFV 24 G25</b>	25		
with levers and gasket, top entry, high construction, without adapter *	<b>CFV 24 G29</b>	29	<b>MFV 24 G32</b>	32		
with levers and gasket, top entry, high construction, without adapter *					<b>MFV 24 G40</b>	40

\* enclosure without adapter, threaded on the body, to be used only with a complete cable gland.

### CHV G (CAV G) and [CFV G], MHV G (MAV G) and [MFV G]

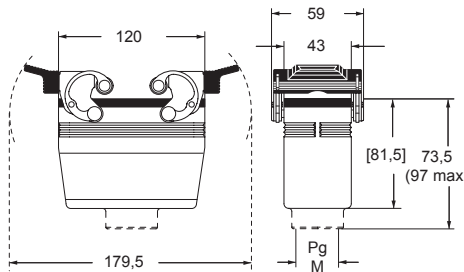

### MFO 16 G40

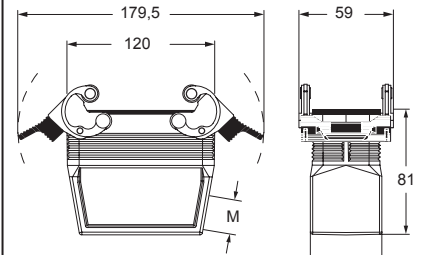

### MFV 16 G40

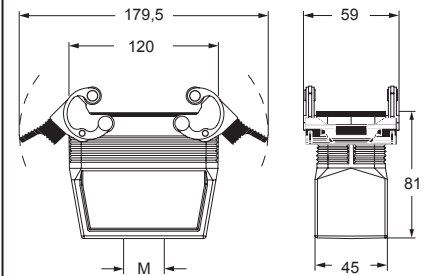

**CALUS** Type 4/4X/12

IP degrees are according to the type of lever and:

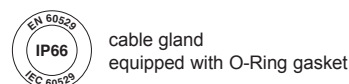
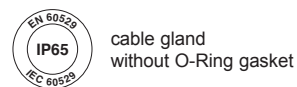

**CH - CA - CF and MH - MA - MF C-TYPE standard version**

inserts		page:
CD	64 poles + ⊕	72
CDD	108 poles + ⊕	81
CDS	42 poles + ⊕	-
CDSH	42 poles + ⊕	89
CNE	24 poles + ⊕	113
CSE	24 poles + ⊕	-
CSH	24 poles + ⊕	113
CSH S	24 poles + ⊕	125
CCE	24 poles + ⊕	133
CMSH	10+2 (aux) poles + ⊕	140
CMCE	10+2 (aux) poles + ⊕	141
CSS	24 poles + ⊕	151
CQE	46 poles + ⊕	171
CQEE	64 poles + ⊕	177
CX	4/8 and 6/6 poles + ⊕	204 and 206
MIXO	6 modules	232 - 287

hoods with 1 lever



hoods with 1 lever  
M40 cable entry with 20 mm thread length



description	part No.	entry Pg	part No.	entry M	part No.	entry M
with levers and gasket, side entry, high construction, without adapter *					<b>MFO 24 LG40</b>	40
with levers and gasket, top entry	<b>CHV 24 LG</b>	21	<b>MHV 24 LG32</b>	32		
with levers and gasket, top entry, high construction	<b>CAV 24 LG21</b>	21	<b>MAV 24 LG25</b>	25		
with levers and gasket, top entry, high construction	<b>CAV 24 LG29</b>	29	<b>MAV 24 LG32</b>	32		
with levers and gasket, top entry, high construction			<b>MAV 24 LG40</b>	40		
with levers and gasket, top entry, high construction, without adapter *	<b>CFV 24 LG21</b>	21	<b>MFV 24 LG25</b>	25		
with levers and gasket, top entry, high construction, without adapter *	<b>CFV 24 LG29</b>	29	<b>MFV 24 LG32</b>	32		
with levers and gasket, top entry, high construction, without adapter *					<b>MFV 24 LG40</b>	40

\* enclosure without adapter, threaded on the body, to be used only with a complete cable gland.

**CHV LG (CAV LG) and [CFV LG],  
MHV LG (MAV LG) and [MFV LG]**

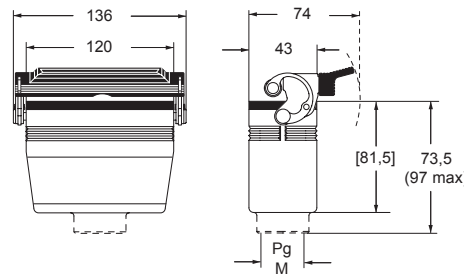

**MFO 24 LG40**

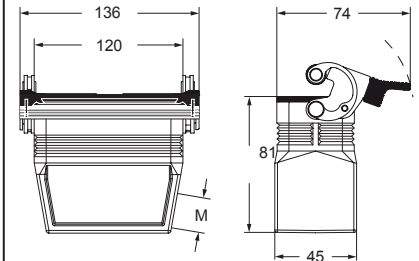

**MFV 24 LG40**

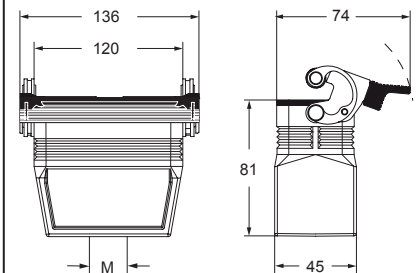

**CRUS** Type 4/4X/12

IP degrees are according to the type of lever and:

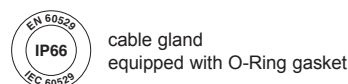
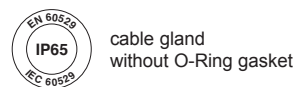

C-TYPE

# CAN C-TYPE standard version

inserts		page:
CD	64 poles + ⊕	72
CDD	108 poles + ⊕	81
CDS	42 poles + ⊕	-
CDSH	42 poles + ⊕	89
CNE	24 poles + ⊕	113
CSE	24 poles + ⊕	-
CSH	24 poles + ⊕	113
CSH S	24 poles + ⊕	125
CCE	24 poles + ⊕	133
CMSH	10+2 (aux) poles + ⊕	140
CMCE	10+2 (aux) poles + ⊕	141
CSS	24 poles + ⊕	151
CQE	46 poles + ⊕	171
CQEE	64 poles + ⊕	177
CX	4/8 and 6/6 poles + ⊕	204 and 206
MIXO	6 modules	232 - 287

## hoods for ribbon cable with 4 pegs



## gaskets for ribbon cable hood



description	part No.	part No.
-------------	----------	----------

with pegs, top entry

**CAN 24**

ribbon cable seals (supplied separately)  
 one slot for cable sizes 18,8 x 5,8 mm  
 one slot for cable sizes 63,8 x 5,1 mm  
 slot for cable sizes 36 x 9 mm  
 not pre-drilled

**CRN 1**  
**CRN 2**  
**CRN 3**  
**CRN P**

\* enclosure without adapter, threaded on the body, to be used only with a complete cable gland.

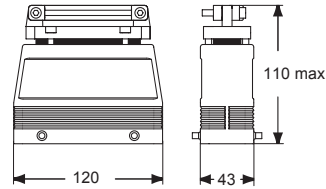

C-TYPE

**CAVUS**® Type 4/4X/12



# CH - CA and MH - MA C-TYPE standard version

inserts		page:
CD	64 poles + ⊕	72
CDD	108 poles + ⊕	81
CDS	42 poles + ⊕	-
CDSH	42 poles + ⊕	89
CNE	24 poles + ⊕	113
CSE	24 poles + ⊕	-
CSH	24 poles + ⊕	113
CSH S	24 poles + ⊕	125
CCE	24 poles + ⊕	133
CMSH	10+2 (aux) poles + ⊕	140
CMCE	10+2 (aux) poles + ⊕	141
CSS	24 poles + ⊕	151
CQE	46 poles + ⊕	171
CQEE	64 poles + ⊕	177
CX	4/8 and 6/6 poles + ⊕	204 and 206
MIXO	6 modules	232 - 287

## hoods with 2 levers

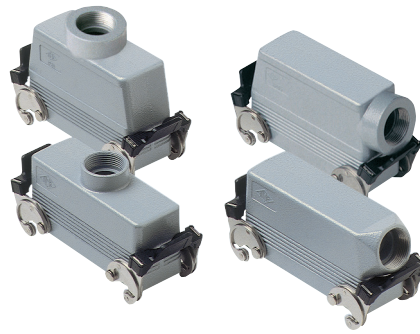

## covers

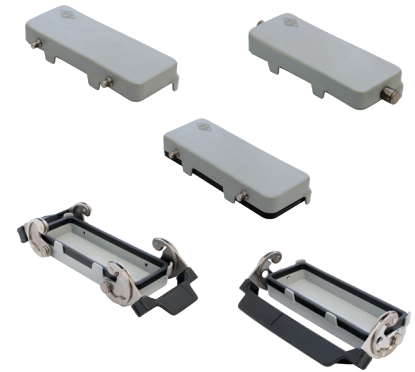

description	part No.	entry Pg	part No	entry M	part No. (with eyelet)	part No. (with loop)
with levers, side entry <sup>1)</sup>	<b>CHO 24 X</b>	21	<b>MHO 24 X25</b>	25		
with levers, side entry <sup>1)</sup>			<b>MHO 24 X32</b>	32		
with levers, side entry, high construction <sup>1)</sup>	<b>CAO 24 X</b>	21	<b>MAO 24 X32</b>	32		
with levers, side entry, high construction <sup>1)</sup>	<b>CAO 24 X29</b>	29	<b>MAO 24 X40</b>	40		
with levers, top entry <sup>1)</sup>	<b>CHV 24 X</b>	21	<b>MHV 24 X25</b>	25		
with levers, top entry <sup>1)</sup>			<b>MHV 24 X32</b>	32		
with levers, top entry, high construction <sup>1)</sup>	<b>CAV 24 X</b>	21	<b>MAV 24 X32</b>	32		
with levers, top entry, high construction <sup>1)</sup>	<b>CAV 24 X29</b>	29	<b>MAV 24 X40</b>	40		
with 4 pegs (for enclosures with 2 levers with gasket)					<b>CHC 24</b>	<b>CHC 24 S</b>
with 4 pegs and gasket (for enclosures with 2 levers) <sup>2)</sup>						<b>CHC 24 C</b>
with 2 pegs (for enclosures with 1 lever with gasket)					<b>CHC 24 L</b>	<b>CHC 24 SL</b>
with 2 levers (for hoods with 4 pegs)						<b>CHC 24 G</b>
with 1 lever (for hoods with 2 pegs)						<b>CHC 24 LG</b>

<sup>1)</sup> may be combined with enclosures:

- CHI/CHP/CAP 16 CS/CP/C
- MHP/MAP 24 CS/CP

<sup>2)</sup> may be combined with enclosures:

- CHO/CAO 24 X and CHV/CAV 24 X
- MHO/MAO 24 X and MHV/MAV 24 X

### CHO X (CAO X) and MHO X (MAO X)

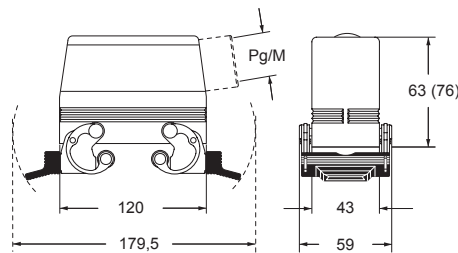

### CHV X (CAV X) and MHV X (MAV X)

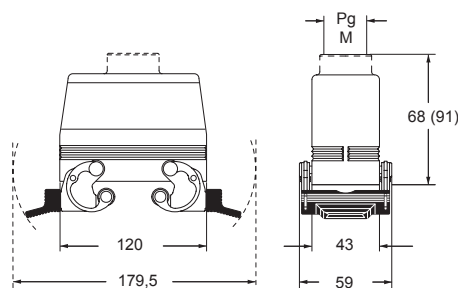

### CHC (S)

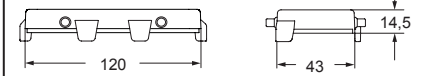

### CHC C

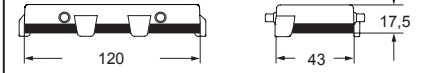

### CHC L (SL)

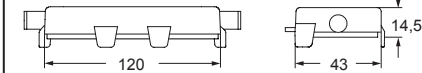

### CHC G

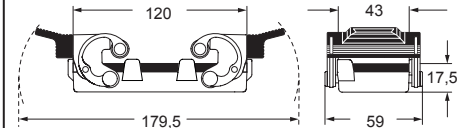

### CHC LG

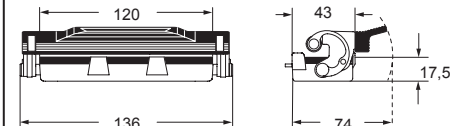

For fixing on housings

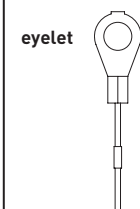

For fixing on hoods

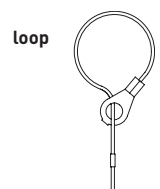

dust protection cover  
**CHCP 24**  
(page 696)



**CAU**® Type  
4/4X/12



C-TYPE



# CAC C-TYPE standard version

inserts		page:
CD	64 poles + ⊕	72
CDD	108 poles + ⊕	81
CDS	42 poles + ⊕	-
CDSH	42 poles + ⊕	89
CNE	24 poles + ⊕	113
CSE	24 poles + ⊕	-
CSH	24 poles + ⊕	113
CSH S	24 poles + ⊕	125
CCE	24 poles + ⊕	133
CMSH	10+2 (aux) poles + ⊕	140
CMCE	10+2 (aux) poles + ⊕	141
CSS	24 poles + ⊕	151
CQE	46 poles + ⊕	171
CQEE	64 poles + ⊕	177
CX	4/8 and 6/6 poles + ⊕	204 and 206
MIXO	6 modules	232 - 287

## hoods without entry, to be drilled



## hoods without entry, to be drilled



description	part No. with 4 pegs	part No. with 2 pegs
-------------	-------------------------	-------------------------

with pegs, high construction

**CAC 24**

**CAC 24 L**

alternatively, hoods with pegs are coupled with fixed enclosures:

- C-TYPE, IP65/IP66 stainless steel lever, from page 258 to page 266
- C7, IP67 stainless steel lever, page 277
- CV, IP66 stainless steel lever, page 283 and 296

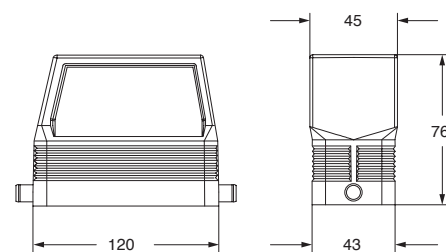
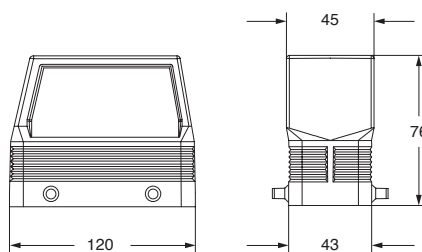

**CAI<sup>®</sup> US** Type 4/4X/12



C-TYPE

# CH C-TYPE standard version

inserts		page:
CD	80 poles + ⊕	73
CDD	144 poles + ⊕	82
CDS	54 poles + ⊕	-
CDSH	54 poles + ⊕	90
CNE	32 poles + ⊕	114
CSE	32 poles + ⊕	-
CSH	32 poles + ⊕	114
CSH S	32 poles + ⊕	126
CCE	32 poles + ⊕	134
CSS	32 poles + ⊕	152
CTSE (16A) *)	32 poles + ⊕	164
CQE	64 poles + ⊕	172
CME	12+4 (aux) poles + ⊕	142
CMSH	12+4 (aux) poles + ⊕	142
CMCE	12+4 (aux) poles + ⊕	143
CP	12 poles + ⊕	179
MIXO	4 + 4 modules	232 - 287

\*) can be used only in bulkhead mounting housings

insert dimensions:  
2 x (77,5 x 27) mm

## bulkhead mounting housings with 2 levers or 4 pegs



## bulkhead mounting housings with single lever



description	part No.	part No.
with one or two levers	<b>CHI 32</b>	<b>CHI 32 L</b>
with pegs and aluminium cover 1)	<b>CHI 32 CS</b>	
with lever and aluminium cover		<b>CHI 32 LS</b>

1) may be combined with enclosures:  
- CHO/CHV/CFO/CFV 32 X  
- MHO/MHV/MFO/MFV 32 X

panel cut-out for bulkhead mounting housings

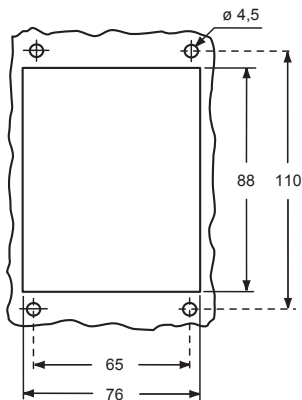

### CHI

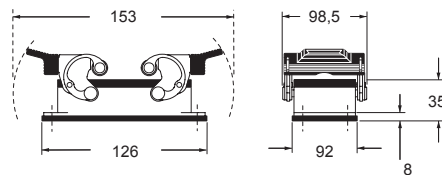

### CHI L

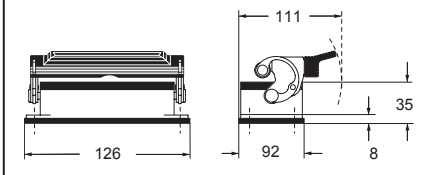

### CHI CS

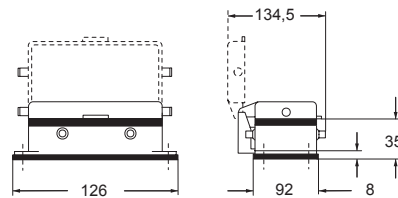

### CHI LS

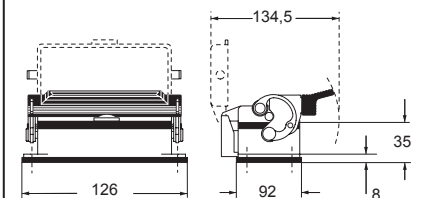

**N.B.:**  
The enclosures ensure IP66 protection (or IP65 for hinged cover versions) rating when mated and locked with the closing levers. The cover (CS) only ensures mechanical protection, but does not ensure IP65 protection rating.

**CAVUS**® Type 4/4X/12



# CH and MH C-TYPE standard version

inserts		page:
CD	80 poles + ⊕	73
CDD	144 poles + ⊕	82
CDS	54 poles + ⊕	-
CDSH	54 poles + ⊕	90
CNE	32 poles + ⊕	114
CSE	32 poles + ⊕	-
CSH	32 poles + ⊕	114
CSH S	32 poles + ⊕	126
CCE	32 poles + ⊕	134
CSS	32 poles + ⊕	152
CQE	64 poles + ⊕	172
CME	12+4 (aux) poles + ⊕	142
CMSH	12+4 (aux) poles + ⊕	142
CMCE	12+4 (aux) poles + ⊕	143
CP	12 poles + ⊕	179
MIXO	4 + 4 modules	232 - 287

insert dimensions:  
2 x (77,5 x 27) mm

## surface mounting housings with 2 levers

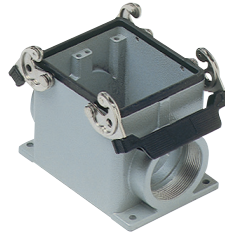

## surface mounting housings with single lever



description	part No.	entry Pg	part No.	entry M	part No.	entry Pg	part No.	entry M
with one or two levers	<b>CHP 32.29</b>	29	<b>MHP 32.40</b>	40	<b>CHP 32 L29</b>	29	<b>MHP 32 L40</b>	40
with one or two levers	<b>CHP 32.229</b>	29 x 2	<b>MHP 32.240</b>	40 x 2	<b>CHP 32 L229</b>	29 x 2	<b>MHP 32 L240</b>	40 x 2
with one or two levers	<b>CHP 32</b>	36	<b>MHP 32.50</b>	50	<b>CHP 32 L</b>	36	<b>MHP 32 L50</b>	50
with one or two levers	<b>CHP 32.2</b>	36 x 2	<b>MHP 32.250</b>	50 x 2	<b>CHP 32 L2</b>	36 x 2	<b>MHP 32 LS250</b>	50 x 2
with one or two levers	<b>CHP 32.42</b>	42			<b>CHP 32 L42</b>	42		
with one or two levers	<b>CHP 32.242</b>	42 x 2			<b>CHP 32 L242</b>	42 x 2		
with lever and aluminium cover					<b>CHP 32 LS29</b>	29	<b>MHP 32 LS40</b>	40
with lever and aluminium cover					<b>CHP 32 LS229</b>	29 x 2	<b>MHP 32 LS240</b>	40 x 2
with lever and aluminium cover					<b>CHP 32 LS</b>	36	<b>MHP 32 LS50</b>	50
with lever and aluminium cover					<b>CHP 32 LS2</b>	36 x 2	<b>MHP 32 LS250</b>	50 x 2
with lever and aluminium cover					<b>CHP 32 LS42</b>	42		
with lever and aluminium cover					<b>CHP 32 LS242</b>	42 x 2		

**N.B.:**  
The enclosures ensure IP66 protection (or IP65 for hinged cover versions) rating when mated and locked with the closing levers. The cover (CS) only ensures mechanical protection, but does not ensure IP65 protection rating.

### CHP and MHP

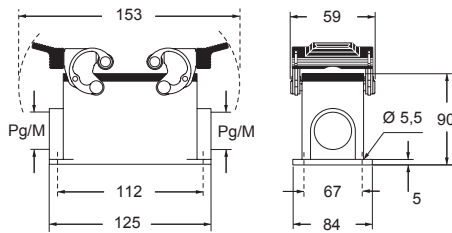

### CHP L and MHP L

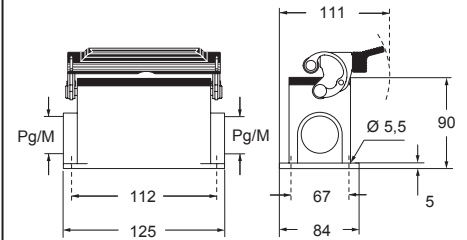

### CHP LS and MHP LS

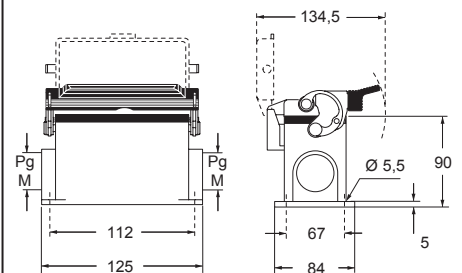

**CUUS**® Type 4/4X/12



# CH - CF and MH - MF C-TYPE standard version

inserts		page:
CD	80 poles + ⊕	73
CDD	144 poles + ⊕	82
CDS	54 poles + ⊕	-
CDSH	54 poles + ⊕	90
CNE	32 poles + ⊕	114
CSE	32 poles + ⊕	-
CSH	32 poles + ⊕	114
CSH S	32 poles + ⊕	126
CCE	32 poles + ⊕	134
CSS	32 poles + ⊕	152
CQE	64 poles + ⊕	172
CME	12+4 (aux) poles + ⊕	142
CMSH	12+4 (aux) poles + ⊕	142
CMCE	12+4 (aux) poles + ⊕	143
CP	12 poles + ⊕	179
MIXO	4 + 4 modules	232 - 287

insert dimensions:  
2 x (77,5 x 27) mm

## hoods with 4 pegs and 2 levers



## hoods with 2 pegs and 1 lever



description	part No.	entry Pg	part No	entry M	part No.	entry Pg	part No.	entry M
with pegs, side entry	<b>CHO 32.29</b>	29	<b>MHO 32.32</b>	32	<b>CHO 32 L</b>	36	<b>MHO 32 L40</b>	40
with pegs, side entry	<b>CHO 32</b>	36	<b>MHO 32.40</b>	40				
with pegs, side entry	<b>CHO 32.42</b>	42	<b>MHO 32.50</b>	50				
with pegs, side entry, without adapter *	<b>CFO 32.29</b>	29	<b>MFO 32.32</b>	32	<b>CFO 32 L</b>	36	<b>MFO 32 L40</b>	40
with pegs, side entry, without adapter *	<b>CFO 32</b>	36	<b>MFO 32.40</b>	40				
with pegs, side entry, without adapter *	<b>CFO 32.42</b>	42	<b>MFO 32.50</b>	50				
with pegs, top entry	<b>CHV 32.29</b>	29	<b>MHV 32.32</b>	32	<b>CHV 32 L</b>	36	<b>MHV 32 L40</b>	40
with pegs, top entry	<b>CHV 32</b>	36	<b>MHV 32.40</b>	40				
with pegs, top entry	<b>CHV 32.42</b>	42	<b>MHV 32.50</b>	50				
with pegs, top entry, without adapter *	<b>CFV 32.29</b>	29	<b>MFV 32.32</b>	32	<b>CFV 32 L</b>	36	<b>MFV 32 L40</b>	40
with pegs, top entry, without adapter *	<b>CFV 32</b>	36	<b>MFV 32.40</b>	40				
with pegs, top entry, without adapter *	<b>CFV 32.42</b>	42	<b>MFV 32.50</b>	50				
with levers and gasket, top entry	<b>CHV 32 G29</b>	29	<b>MHV 32 G32</b>	32	<b>CHV 32 LG</b>	36	<b>MHV 32 LG40</b>	40
with one or two levers and gasket, top entry	<b>CHV 32 G</b>	36	<b>MHV 32 G40</b>	40				
with levers and gasket, top entry	<b>CHV 32 G42</b>	42	<b>MHV 32 G50</b>	50				
with levers and gasket, top entry, without adapter *	<b>CFV 32 G29</b>	29	<b>MFV 32 G32</b>	32	<b>CFV 32 LG</b>	36	<b>MFV 32 LG40</b>	40
with lever/s and gasket, top entry, without adapter *	<b>CFV 32 G</b>	36	<b>MFV 32 G40</b>	40				
with levers and gasket, top entry, without adapter *	<b>CFV 32 G42</b>	42	<b>MFV 32 G50</b>	50				

\* enclosure without adapter, threaded on the body, to be used only with a complete cable gland.

### CHO/CFO and MHO/MFO

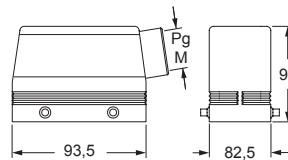

### CHO/CFO L and MHO/MFO L

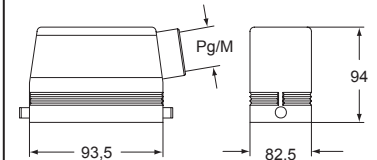

### CHV/CFV and MHV/MFV

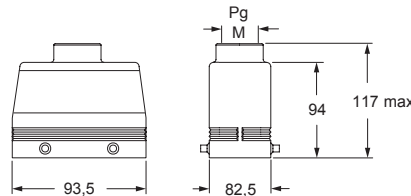

### CHV/CFV L and MHV/MFV L

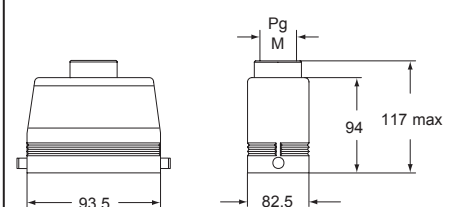

### CHV/CFV G and MHV/MFV G

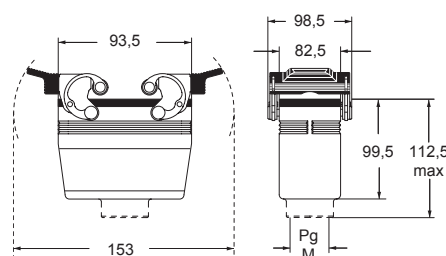

### CHV/CFV LG and MHV/MFV LG

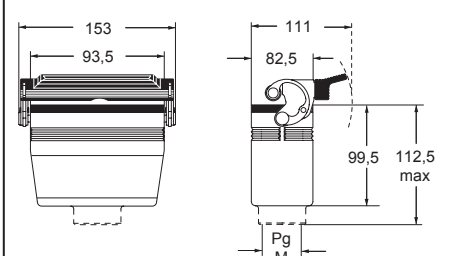

**CAIUS** Type 4/4X/12



IP67 if hoods with fused pegs and without adapters coupled with IP67 housings

C-TYPE

# CH - CF and MH - MF C-TYPE standard version

inserts		page:
CD	80 poles + ⊕	73
CDD	144 poles + ⊕	82
CDS	54 poles + ⊕	-
CDSH	54 poles + ⊕	90
CNE	32 poles + ⊕	114
CSE	32 poles + ⊕	-
CSH	32 poles + ⊕	114
CSH S	32 poles + ⊕	126
CCE	32 poles + ⊕	134
CSS	32 poles + ⊕	152
CQE	64 poles + ⊕	172
CME	12+4 (aux) poles + ⊕	142
CMSH	12+4 (aux) poles + ⊕	142
CMCE	12+4 (aux) poles + ⊕	143
CP	12 poles + ⊕	179
MIXO	4 + 4 modules	232 - 287

insert dimensions:  
2 x (77,5 x 27) mm

## hoods with 2 levers

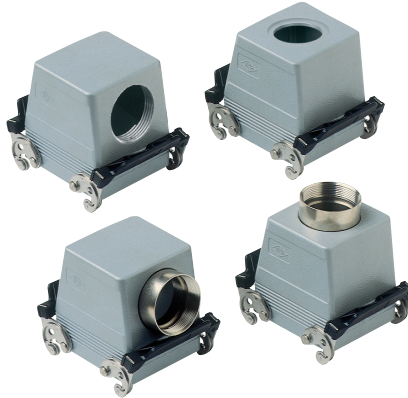

## covers

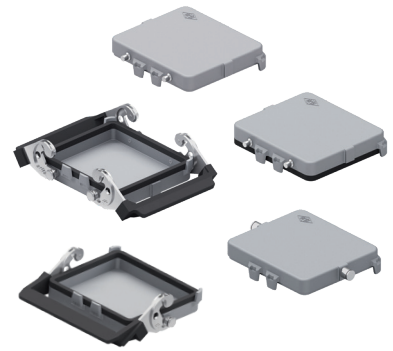

description	part No.	entry Pg	part No	entry M	part No. (with eyelet)	part No. (with loop)
with levers, side entry <sup>1)</sup>	<b>CHO 32 X</b>	36	<b>MHO 32 X40</b>	40	<b>CHC 32</b>	<b>CHC 32 S</b>
with levers, side entry, without adaptor * <sup>1)</sup>	<b>CFO 32 X</b>	36	<b>MFO 32 X40</b>	40		<b>CHC 32 C</b>
with levers, top entry <sup>1)</sup>	<b>CHV 32 X</b>	36	<b>MHV 32 X40</b>	40	<b>CHC 32 L</b>	<b>CHC 32 SL</b>
with levers, top entry, without adaptor * <sup>1)</sup>	<b>CFV 32 X</b>	36	<b>MFV 32 X40</b>	40		<b>CHC 32 G</b>
with 4 pegs (for enclosures with 2 levers with gasket)						<b>CHC 32 LG</b>
with 4 pegs and gasket (for enclosures with 2 levers) <sup>2)</sup>						
with 2 pegs (for enclosures with 1 lever with gasket)						
with 2 levers (for hoods with 4 pegs)						
with 1 lever (for hoods with 2 pegs)						

\* enclosure without adapter, threaded on the body, to be used only with a complete cable gland.

<sup>1)</sup> may be combined with CHI 32 CS enclosures

<sup>2)</sup> may be combined with enclosures:  
- CHO/CFO 32 X and CHV/CFV 32 X  
- MHO/MFO 32 X and MHV/MFV 32 X

### CHO/CFO X and MHO/MFO X

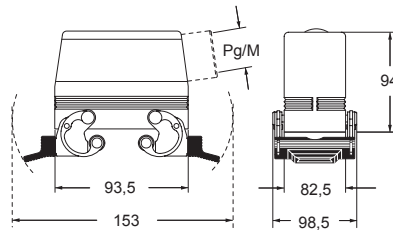

### CHV/CFV X and MHV/MFV X

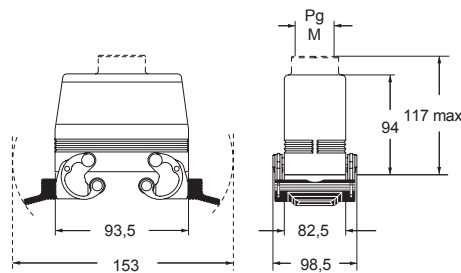

### CHC (S)

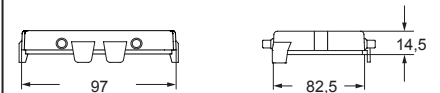

### CHC C

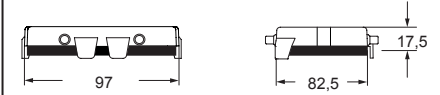

### CHC L (SL)

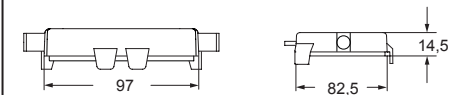

### CHC G

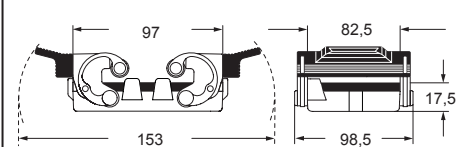

### CHC LG

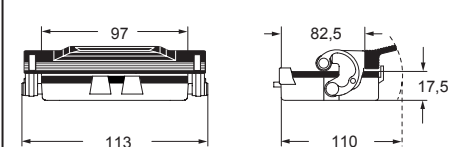

For fixing on housings

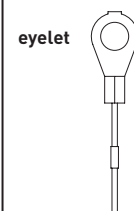

For fixing on hoods

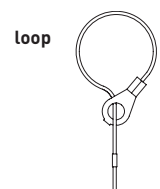

**CAU**® Type 4/4X/12



# CHIX C-TYPE standard version RIGID LEVER

inserts		page:
CD	80 poles + ⊕	73
CDD	144 poles + ⊕	82
CDS	54 poles + ⊕	-
CDSH	54 poles + ⊕	90
CNE	32 poles + ⊕	114
CSE	32 poles + ⊕	-
CSH	32 poles + ⊕	114
CSH S	32 poles + ⊕	126
CCE	32 poles + ⊕	134
CSS	32 poles + ⊕	152
CTSE (16A) *	32 poles + ⊕	164
CQE	64 poles + ⊕	172
CME	12+4 (aux) poles + ⊕	142
CMSH	12+4 (aux) poles + ⊕	142
CMCE	12+4 (aux) poles + ⊕	143
CP	12 poles + ⊕	179
MIXO	4 + 4 modules	232 - 287

\*) can be used only in bulkhead mounting housings

insert dimensions:  
2 x (77,5 x 27) mm

## bulkhead mounting housings with single lever

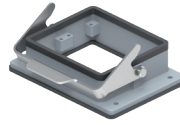

**STAINLESS STEEL RIGID LEVER**

## bulkhead mounting housings with single lever, with cover



**STAINLESS STEEL RIGID LEVER**

description

part No.

part No.

with lever

**CHIX 32 L**

with lever and aluminum cover

**CHIX 32 LS**

with lever and plastic cover

**CHIX 32 LP**

The enclosures ensure IP66 degree of protection (or IP65 for cover versions) rating when mated and locked with the closing levers.

available upon request in "W-TYPE" version for aggressive environment and in 180 °C version for high temperatures.

panel cut-out for bulkhead mounting housings

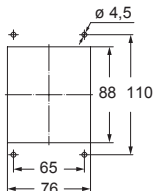

### CHIX L

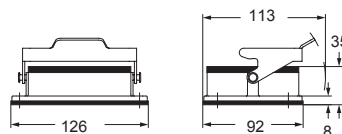

### CHIX LS and CHIX LP

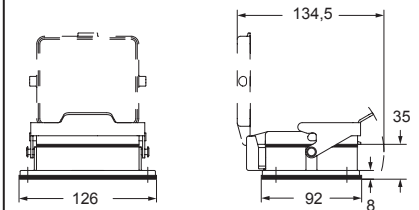

cURus  
Type 12 / Type 4/4X  
(except enclosures with plastic cover)  
pending





# CHPX C-TYPE standard version RIGID LEVER

inserts		page:
CD	80 poles + ⊕	73
CDD	144 poles + ⊕	82
CDS	54 poles + ⊕	-
CDSH	54 poles + ⊕	90
CNE	32 poles + ⊕	114
CSE	32 poles + ⊕	-
CSH	32 poles + ⊕	114
CSH S	32 poles + ⊕	126
CCE	32 poles + ⊕	134
CSS	32 poles + ⊕	152
CTSE (16A) *	32 poles + ⊕	164
CQE	64 poles + ⊕	172
CME	12+4 (aux) poles + ⊕	142
CMSH	12+4 (aux) poles + ⊕	142
CMCE	12+4 (aux) poles + ⊕	143
CP	12 poles + ⊕	179
MIXO	4 + 4 modules	232 - 287

\*) can be used only in bulkhead mounting housings

insert dimensions:  
2 x (77,5 x 27) mm

description	part No.	entry Pg	part No.	entry M	part No.	entry Pg	part No.	entry M
with lever	<b>CHPX 32 L29</b>	29						
with lever	<b>CHPX 32 L</b>	36	<b>MHPX 32 L40</b>	40				
with lever and aluminum cover					<b>CHPX 32 LS29</b>	29		
with lever and aluminum cover					<b>CHPX 32 LS</b>	36	<b>MHPX 32 LS40</b>	40
with lever and plastic cover					<b>CHPX 32 LP29</b>	29		
with lever and plastic cover					<b>CHPX 32 LP</b>	36	<b>MHPX 32 LP40</b>	40
with lever and plastic cover							<b>MHPX 32 LP50</b>	50

☑ The enclosures ensure IP66 degree of protection (or IP65 for cover versions) rating when mated and locked with the closing levers.

available upon request in "W-TYPE" version for aggressive environment and in 180 °C version for high temperatures.

### CHPX L and MHPX L

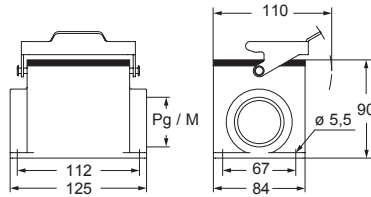

### CHPX LS - MHPX LS and CHPX LP - MHPX LP

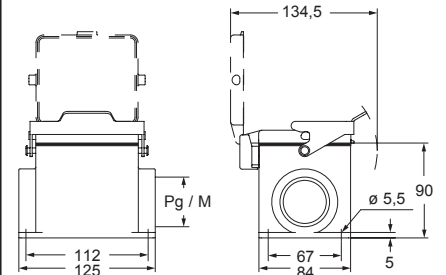

cURus  
Type 12 / Type 4/4X  
(except enclosures with plastic cover)  
pending



# CH - CF and MH - MF C-TYPE standard version

inserts		page:
CD	128 poles + ⊕	74
CDD	216 poles + ⊕	83
CDS	84 poles + ⊕	-
CDSH	84 poles + ⊕	91
CNE	48 poles + ⊕	115
CSE	48 poles + ⊕	-
CSH	48 poles + ⊕	115
CSH S	48 poles + ⊕	127
CCE	48 poles + ⊕	135
CME	20+4 (aux) poles + ⊕	144
CMSh	20+4 (aux) poles + ⊕	144
CSS	48 poles + ⊕	153
CTSE (16A) *	48 poles + ⊕	165
CQE	92 poles + ⊕	173
MIXO	6 + 6 modules	232 - 287

\*) can be used only in bulkhead mounting housings

insert dimensions:  
2 x (104 x 27) mm

## bulkhead and surface mounting enclosures with single lever



## hoods with 2 pegs



description	part No.	entry Pg	part No	entry M	part No.	entry Pg	part No.	entry M
bulkhead mounting enclosures with lever	<b>CHI 48 L</b>	—						
bulkhead mounting enclosures with lever and cover	<b>CHI 48 LS</b>	—						
surface mounting enclosures with lever and cover	<b>CHP 48 LS29</b>	29 x 2	<b>MHP 48 LS40</b>	40 x 2				
surface mounting enclosures with lever and cover	<b>CHP 48 LS</b>	36 x 2	<b>MHP 48 LS50</b>	50 x 2				
with pegs, side entry					<b>CHO 48 L29</b>	29	<b>MHO 48 L32</b>	32
with pegs, side entry					<b>CHO 48 L</b>	36	<b>MHO 48 L40</b>	40
with pegs, side entry					<b>CHO 48 L42</b>	42	<b>MHO 48 L50</b>	50
with pegs, side entry, without adapter *					<b>CFO 48 L29</b>	29	<b>MFO 48 L32</b>	32
with pegs, side entry, without adapter *					<b>CFO 48 L</b>	36	<b>MFO 48 L40</b>	40
with pegs, side entry, without adapter *					<b>CFO 48 L42</b>	42	<b>MFO 48 L50</b>	50
with pegs, top entry					<b>CHV 48 L29</b>	29	<b>MHV 48 L32</b>	32
with pegs, top entry					<b>CHV 48 L</b>	36	<b>MHV 48 L40</b>	40
with pegs, top entry					<b>CHV 48 L42</b>	42	<b>MHV 48 L50</b>	50
with pegs, top entry, without adaptor *					<b>CFV 48 L29</b>	29	<b>MFV 48 L32</b>	32
with pegs, top entry, without adaptor *					<b>CFV 48 L</b>	36	<b>MFV 48 L40</b>	40
with pegs, top entry, without adaptor *					<b>CFV 48 L42</b>	42	<b>MFV 48 L50</b>	50

\* enclosure without adapter, threaded on the body, to be used only with a complete cable gland.

### panel cut-out for bulkhead mounting housings

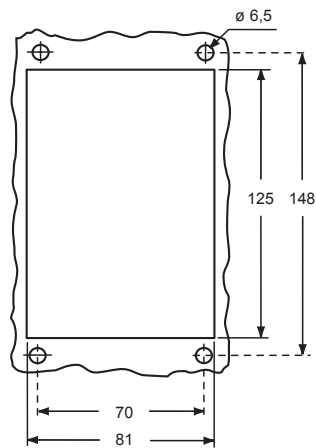

**N.B.:**  
The enclosures ensure IP66 protection (or IP65 for hinged cover versions) rating when mated and locked with the closing levers.

### CHI L - LS

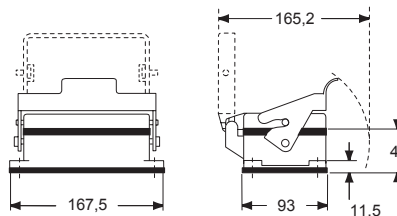

### CHP LS and MHP LS

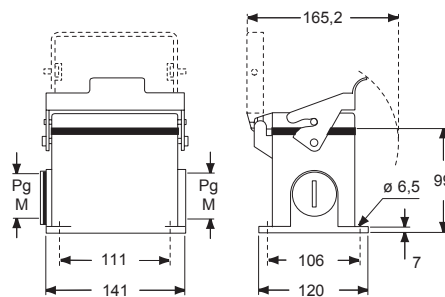

### CHO/CFO L and MHO/MFO L

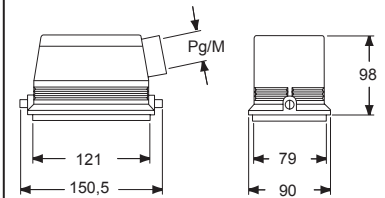

### CHV/CFV L and MHV/MFV L

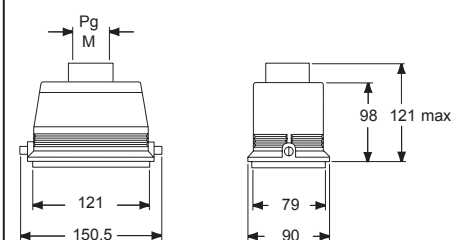

**CAVUS**® Type 4/4X/12



# CH and MH C-TYPE standard version

**inserts**

insert	poles + ⊕	page:
CD	50 poles + ⊕	71
CDD	76 poles + ⊕	80
CDA	32 poles + ⊕	102
CSAH	32 poles + ⊕	103
CDC	32 poles + ⊕	106

insert dimensions:  
2 x (66 x 16) mm

**bulkhead mounting housings with 2 levers or 4 pegs**



**surface mounting housings with 2 levers or 4 pegs**



description	part No.	part No.	entry Pg	part No.	entry M
with levers	<b>CHI 50</b>				
with pegs and cover 1)	<b>CHI 50 CS</b>				
with levers		<b>CHP 50.21</b>	21	<b>MHP 50.32</b>	32
with levers		<b>CHP 50.221</b>	21 x 2	<b>MHP 50.232</b>	32 x 2
with levers		<b>CHP 50.29</b>	29	<b>MHP 50.40</b>	40
with levers		<b>CHP 50.229</b>	29 x 2	<b>MHP 50.240</b>	40 x 2
with pegs and cover 1)		<b>CHP 50 CS</b>	21	<b>MHP 50 CS32</b>	32
with pegs and cover 1)		<b>CHP 50 CS2</b>	21 x 2	<b>MHP 50 CS232</b>	32 x 2
with pegs and cover 1)		<b>CHP 50 CS29</b>	29	<b>MHP 50 CS40</b>	40
with pegs and cover 1)		<b>CHP 50 CS229</b>	29 x 2	<b>MHP 50 CS240</b>	40 x 2

1) may be combined with enclosures:  
- CHO/CAO 50 X and CAV 50 X  
- MHO/MAO/MFO 50 X and MAV/MFV 50 X

panel cut-out for bulkhead mounting housings

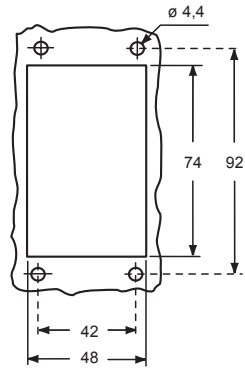

**CHI**

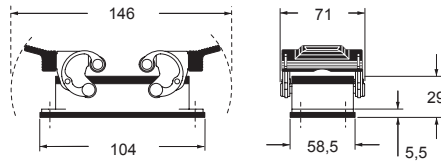

**CHI CS**

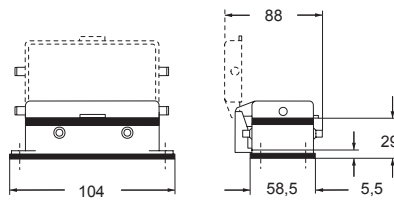

**CHP and MHP**

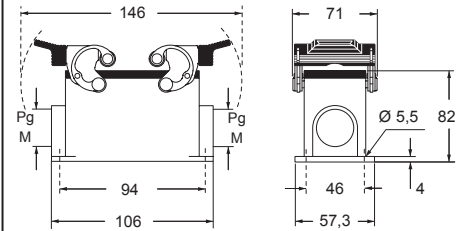

**CHP CS and MHP CS**

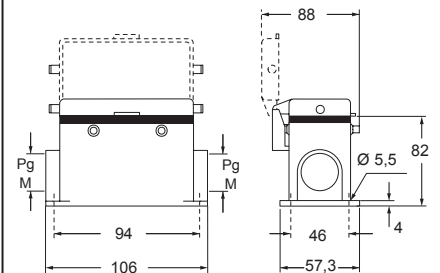

**N.B.:**  
The enclosures ensure IP66 protection (or IP65 for hinged cover versions) rating when mated and locked with the closing levers. The cover (CS, CP) only ensures mechanical protection, but does not ensure IP65 protection rating.

**CUUS** Type 4/4X/12



**CH - CA - CF and MH - MA - MF C-TYPE standard version**

inserts		page:
CD	50 poles + ⊕	71
CDD	76 poles + ⊕	80
CDA	32 poles + ⊕	102
CSAH	32 poles + ⊕	103
CDC	32 poles + ⊕	106

insert dimensions:  
2 x (66 x 16) mm

hoods with 4 pegs



hoods with 2 levers or 4 pegs



description	part No.	entry Pg	part No.	entry M	part No.	entry Pg	part No.	entry M
with pegs, side entry	<b>CHO 50</b>	21	<b>MHO 50.25</b>	25				
with pegs, side entry			<b>MHO 50.32</b>	32				
with pegs, side entry, high construction	<b>CAO 50.21</b>	21	<b>MAO 50.25</b>	25				
with pegs, side entry, high construction	<b>CAO 50.29</b>	29	<b>MAO 50.32</b>	32				
with pegs, top entry, high construction					<b>CAV 50.21</b>	21	<b>MAV 50.25</b>	25
with pegs, top entry, high construction					<b>CAV 50.29</b>	29	<b>MAV 50.32</b>	32
with levers and gasket, top entry, high construction					<b>CAV 50 G29</b>	29	<b>MAV 50 G32</b>	32
with pegs, side entry, high construction, without adapter *	<b>CFO 50.21</b>	21	<b>MFO 50.25</b>	25				
with pegs, side entry, high construction, without adapter *	<b>CFO 50.29</b>	29	<b>MFO 50.32</b>	32				
with pegs, top entry, high construction, without adapter *					<b>CFV 50.21</b>	21	<b>MFV 50.25</b>	25
with pegs, top entry, high construction, without adapter *					<b>CFV 50.29</b>	29	<b>MFV 50.32</b>	32
with levers and gasket, top entry, high, without adapter *					<b>CFV 50 G29</b>	29	<b>MFV 50 G32</b>	32

\* enclosure without adapter, threaded on the body, to be used only with a complete cable gland.

**CHO (CAO/CFO) and MHO (MAO/MFO)**

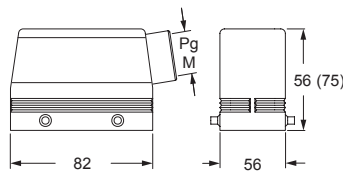

**CAV (CFV) and MAV (MFV)**

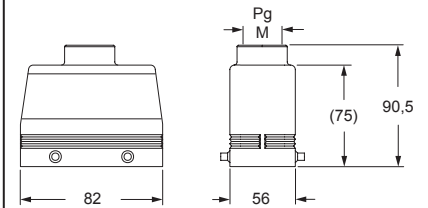

**CAV G (CFV G) and MAV G (MFV G)**

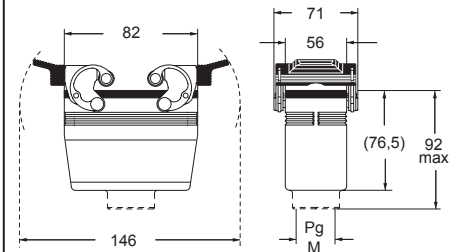

**CAIUS** Type 4/4X/12



IP66 if hoods with fused pegs and without adapters coupled with IP67 housings

C-TYPE

# CH - CA - CF and MH - MA - MF C-TYPE standard version

inserts		page:
CD	50 poles + ⊕	71
CDD	76 poles + ⊕	80
CDA	32 poles + ⊕	102
CSAH	32 poles + ⊕	103
CDC	32 poles + ⊕	106

insert dimensions:  
2 x (66 x 16) mm

## hoods with 2 levers

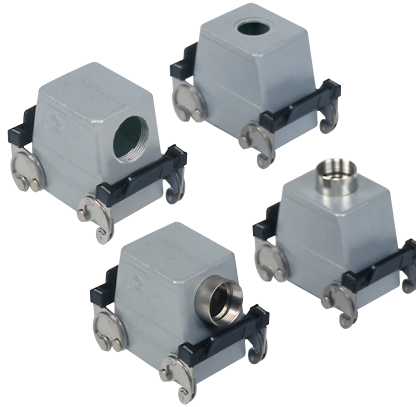

## covers

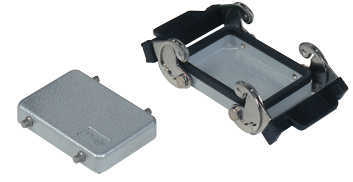

description	part No.	entry Pg	part No	entry M	part No. (with eyelet)	part No. (with loop)
with levers, side entry <sup>1)</sup>	<b>CHO 50 X</b>	21	<b>MHO 50 X25</b>	25		
with levers, side entry <sup>1)</sup>			<b>MHO 50 X32</b>	32		
with levers, side entry, high construction <sup>1)</sup>	<b>CAO 50 X</b>	21	<b>MAO 50 X25</b>	25		
with levers, side entry, high construction <sup>1)</sup>	<b>CAO 50 X29</b>	29	<b>MAO 50 X32</b>	32		
with levers, top entry, high construction <sup>1)</sup>	<b>CAV 50 X</b>	21	<b>MAV 50 X25</b>	25		
with levers, top entry, high construction <sup>1)</sup>	<b>CAV 50 X29</b>	29	<b>MAV 50 X32</b>	32		
with levers, side entry, high construction, without adapter <sup>1)</sup> *	<b>CFO 50 X</b>	21	<b>MFO 50 X25</b>	25		
with levers, side entry, high construction, without adapter <sup>1)</sup> *	<b>CFO 50 X29</b>	29	<b>MFO 50 X32</b>	32		
with levers, top entry, high construction, without adapter <sup>1)</sup> *	<b>CFV 50 X</b>	21	<b>MFV 50 X25</b>	25		
with levers, top entry, high construction, without adapter <sup>1)</sup> *	<b>CFV 50 X29</b>	29	<b>MFV 50 X32</b>	32		
with 4 pegs (for enclosures with 2 levers)					<b>CHC 50</b>	<b>CHC 50 S</b>
with 2 levers and gasket (for hoods with 4 pegs)						<b>CHC 50 G</b>

<sup>1)</sup> may be combined with enclosures:  
- CHI 50 CS, CHP 50 CS and MHP 50 CS

\* enclosure without adapter, threaded on the body, to be used only with a complete cable gland.

### CHO X (CAO X/CFO X) and MHO X (MAO X/MFO X)

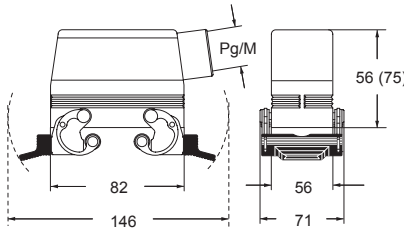

### CAV X (CFV X) and MAV X (MFV X)

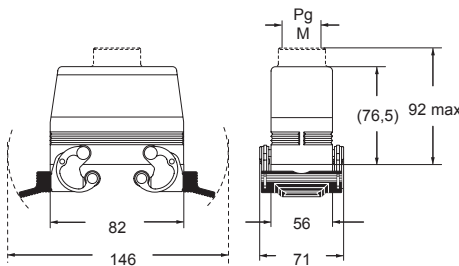

### CHC(S)



### CHC G

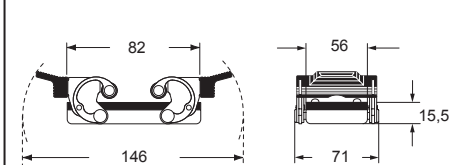

For fixing on housings

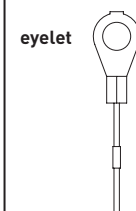

For fixing on hoods

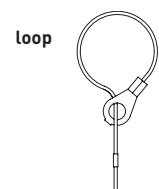

**CAU**® Type 4/4X/12



IP67 if hoods with fused pegs and without adapters coupled with IP67 housings

# CAC C-TYPE standard version

inserts		page:
CD	50 poles + ⊕	71
CDD	76 poles + ⊕	80
CDA	32 poles + ⊕	102
CSAH	32 poles + ⊕	103
CDC	32 poles + ⊕	106

insert dimensions:  
2 x (66 x 16) mm

hoods without entry, to be drilled



description	part No. with 4 pegs
-------------	-------------------------

with pegs, high construction	<b>CAC 50</b>
------------------------------	---------------

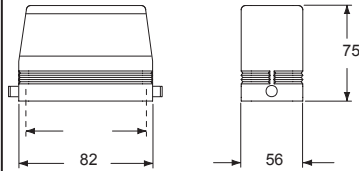

C-TYPE

**CAI<sup>®</sup> US** Type 4/4X/12





## V-TYPE

### Extra tough

The performance requirements in **connection protection** are increasingly varied and specialized.

To respond to this wide range of needs, **ILME has developed several original solutions, including the innovative V-TYPE lever.**

This proprietary lever, due to the **vertical closing movement, offers an IP66/IP67 degree of protection** (according to EN 60529) when fitted with a complete and coupled connector **and used with ILME standard hoods in die cast aluminium moulded (without adaptor).**

The high degree of protection is therefore not dependant on the use of special gaskets or locking devices.

**The fixing flanges are the same** as those fitted on traditional models.

This means it is possible to use the new housings **as alternatives to the traditional version without affecting the interchangeability**, or changing dimensions, spaces, flanges or fixing positions.

This lever differs from other commercial ones because of its closing movement principle, consisting of 2 hinged elements that are then pivoted on the housing.

This composite movement enables to move the lever above the pin of the housing that has to be fixed in place with an initial rotatory movement and then press it downwards to engage the locking mechanism.

**The tight seal after closure and the simplicity of the movement** are key characteristics that **only ILME has managed to combine into a single lever.**

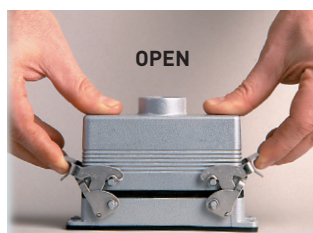

#### SUM-UP

The V-TYPE lever also has other interesting functional characteristics for several applications:

- ☑ **The friction on the pin is almost zero because the lever exerts its pressure vertically, thus significantly reducing wear in case of frequent use.**
- ☑ **The complete lever is manufactured in stainless steel and is fitted with a catch that prevents it from being accidentally detached.**
- ☑ **The absence of parts in plastic offers a higher resistance to impacts and in case of contact with oils and aggressive chemical substances or high ambient temperatures.**
- ☑ **The lever can be used for applications with vibrations because it has no springs and is therefore more rigid.**
- ☑ **The lever occupies a very small space during the closing phase.**
- ☑ **It is recommended in cases when the cable weight forces the levers to open, such as vertically installed connectors and the cable is mounted in the bottom.**

The interchangeability with equivalent traditional levers with springs and rollers **simplifies the management of stocks, reduces costs and increases flexibility of use.**

Available in bulkhead or surface-mounted versions for sizes 44.27 with a single lever, 57.27, 77.27 and 104.27 with 2 levers. High construction models are available on request.

**The item code** identifies the series with the **suffix C7 or M7:**

- **C7I** bulkhead mounting housing
- **C7P** surface mounting housing, Pg thread, standard height
- **M7P** surface mounting housing, metric thread, standard height
- **C7AP** surface mounting housing, Pg thread, high
- **M7AP** surface mounting housing, metric thread, high.

**C7 - C7A and M7 - M7A IP67 enclosures V-TYPE lever version**

inserts		page:
CDD	24 poles + ⊕	76
CDS	9 poles + ⊕	-
CDSH	9 poles + ⊕	86
CDSH NC	6 poles + ⊕	95
CNE	6 poles + ⊕	110
CSE	6 poles + ⊕	-
CSH	6 poles + ⊕	110
CSH S	6 poles + ⊕	122
CCE	6 poles + ⊕	130
CSS	6 poles + ⊕	148
CT, CTSE (16A) *	6 poles + ⊕	160
CQE	10 poles + ⊕	168
MIXO	2 modules	232 - 28

\*) can be used only in bulkhead mounting housings

**bulkhead mounting housings with stainless steel single lever**



**surface mounting housings with stainless steel single lever**



description	part No.	entry	part No.	entry
		Pg		M
with lever and gasket, size "44.27"	<b>C7I 06 L</b>			
with lever, size "44.27"			<b>C7P 06 L</b>	16
with lever, size "44.27"			<b>C7P 06 L2</b>	16 x 2
with lever, high construction, size "44.27"			<b>C7AP 06 L</b>	21
with lever, high construction, size "44.27"			<b>C7AP 06 L2</b>	21 x 2
with lever, high construction, size "44.27"			<b>C7AP 06 L29</b>	29
with lever, high construction, size "44.27"			<b>C7AP 06 L229</b>	29 x 2
			<b>M7P 06 L20</b>	20
			<b>M7P 06 L220</b>	20 x 2
			<b>M7AP 06 L32</b>	32
			<b>M7AP 06 L232</b>	32 x 2
			<b>M7AP 06 L40</b>	40
			<b>M7AP 06 L240</b>	40 x 2

panel cut-out for bulkhead mounting housings

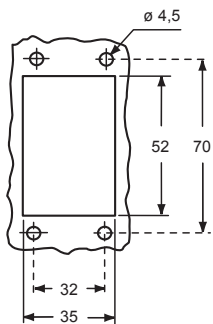

The lever, due to the vertical closing movement, offers an IP66/IP67 degree of protection (according to EN 60529) when fitted with a complete and coupled connector and used with ILME standard hoods in die cast aluminum with pegs (without adapter).

**Hoods (page 389)**



**Hoods (page 466 - 467)**

**C7I L**

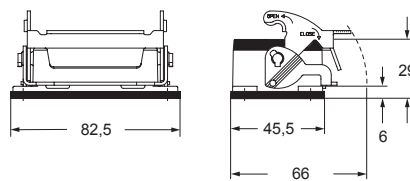

For bulkhead mounting housings, IP66/IP67 degree of protection is guaranteed for mounting on a sufficiently rigid panel; use suitable length M4 screws (negligible surface buckling when subjected to tightening couple on the fixing screws of 0,8 - 1,2 Nm or deformation caused by the weight of the complete connector). In case of insufficient rigidity use of C7.. FL counterflanges (page 443) is recommended, in which case use suitable length M4 screws and M4 (on the enclosure) and M4 (on the counterflange) flat/spring washers with M4 locknut. In addition, the panel surface in contact with the counterflange gasket of the bulkhead mounting housings must be free from defects (deep scratches, grooves, burrs) that could negatively affect the performance of the gasket.

**C7P L - C7AP L and M7P L - M7AP L**

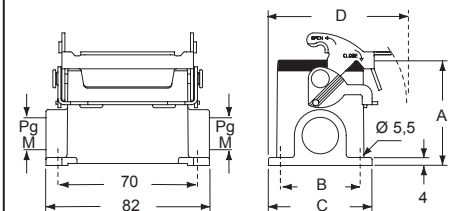

type	A	B	C	D
<b>C7P/M7P 06 L</b>	53	40	52	70
<b>C7AP/M7AP 06 L</b>	74	45	57	72,5

**CAUS** Type 4/4X/12



# C7 and M7 - M7A IP67 enclosures V-TYPE lever version

inserts		page:
CDD	24 poles + ⊕	76
CDS	9 poles + ⊕	-
CDSH	9 poles + ⊕	86
CDSH NC	6 poles + ⊕	95
CNE	6 poles + ⊕	110
CSE	6 poles + ⊕	-
CSH	6 poles + ⊕	110
CSH S	6 poles + ⊕	122
CCE	6 poles + ⊕	130
CSS	6 poles + ⊕	148
CT, CTSE (16A *)	6 poles + ⊕	160
CQE	10 poles + ⊕	168
MIXO	2 modules	232 - 28

\*) can be used only in bulkhead mounting housings

## bulkhead mounting housings with stainless steel single lever and metal cover



## surface mounting housings with stainless steel single lever and metal cover



description	part No.	part No.	entry M
with lever, cover and gasket, size "44.27"	<b>C71 06 LS</b>		
with lever and cover, size "44.27"		<b>M7P 06 LS20</b>	20
with lever and cover, size "44.27"		<b>M7P 06 LS220</b>	20 x 2
with lever and cover, high construction, size "44.27"		<b>M7AP 06 LS32</b>	32
with lever and cover, high construction, size "44.27"		<b>M7AP 06LS232</b>	32 x 2
with lever and cover, high construction, size "44.27"		<b>M7AP 06 LS40</b>	40
with lever and cover, high construction, size "44.27"		<b>M7AP 06LS240</b>	40 x 2

### panel cut-out for bulkhead mounting housings

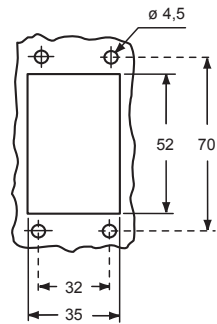

The lever, due to the vertical closing movement, offers an IP66/IP67 degree of protection (according to EN 60529) when fitted with a complete and coupled connector and used with ILME standard hoods in die cast aluminum with pegs (without adapter).

### Hoods (page 389)



### Hoods (page 466 - 467)

### C71 LS

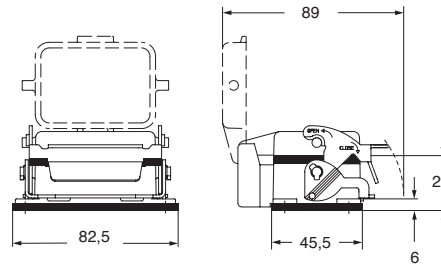

For bulkhead mounting housings, IP66/IP67 degree of protection is guaranteed for mounting on a sufficiently rigid panel; use suitable length M4 screws (negligible surface buckling when subjected to tightening couple on the fixing screws of 0,8 - 1,2 Nm or deformation caused by the weight of the complete connector). In case of insufficient rigidity use of C7.. FL counterflanges (page 443) is recommended, in which case use suitable length M4 screws and M4 (on the enclosure) and M4 (on the counterflange) flat/spring washers with M4 locknut. In addition, the panel surface in contact with the counterflange gasket of the bulkhead mounting housings must be free from defects (deep scratches, grooves, burrs) that could negatively affect the performance of the gasket.

### M7P LS - M7AP LS

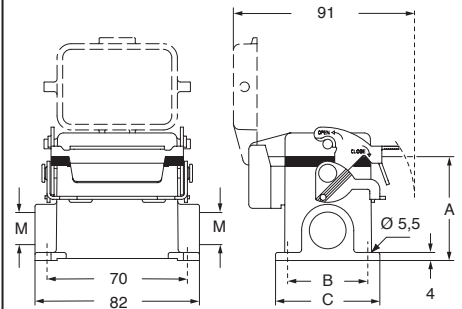

type	A	B	C
<b>M7P 06 LS</b>	53	40	52
<b>M7AP 06 LS</b>	74	45	57

**CU**® Type 4/4X/12



# C7 - C7A and M7 - M7A IP67 enclosures V-TYPE lever version

inserts		page:
CDD	42 poles + ⊕	78
CDS	18 poles + ⊕	-
CDSH	18 poles + ⊕	87
CNE	10 poles + ⊕	111
CSE	10 poles + ⊕	-
CSH	10 poles + ⊕	111
CSH S	10 poles + ⊕	123
CCE	10 poles + ⊕	131
CMSH	3+2 (aux) poles + ⊕	136
CMCE	3+2 (aux) poles + ⊕	137
CSS	10 poles + ⊕	149
CT, CTSE (16A) *)	10 poles + ⊕	161
CQE	18 poles + ⊕	169
CX	8/24 poles + ⊕	194
MIXO	3 modules	232 - 287

\*) can be used only in bulkhead mounting housings

## bulkhead mounting housings with 2 levers in stainless steel

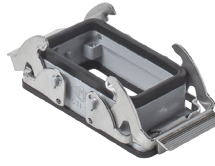

## surface mounting housings with 2 levers in stainless steel



description	part No.	part No.	entry Pg	part No.	entry M
with levers and gasket, size "57.27"	<b>C71 10</b>				
with levers, size "57.27"		<b>C7P 10</b>	16	<b>M7P 10.20</b>	20
with levers, size "57.27"		<b>C7P 10.2</b>	16 x 2	<b>M7P 10.220</b>	20 x 2
with levers, high construction, size "57.27"		<b>C7AP 10.21</b>	21	<b>M7AP 10.32</b>	32
with levers, high construction, size "57.27"		<b>C7AP 10.221</b>	21 x 2	<b>M7AP 10.232</b>	32 x 2
with levers, high construction, size "57.27"	443	<b>C7AP 10.29</b>	29	<b>M7AP 10.40</b>	40
with levers, high construction, size "57.27"		<b>C7AP 10.229</b>	29 x 2	<b>M7AP 10.240</b>	40 x 2

panel cut-out for bulkhead mounting housings

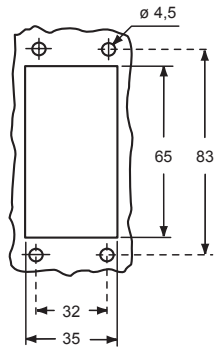

The lever, due to the vertical closing movement, offers an IP66/IP67 degree of protection (according to EN 60529) when fitted with a complete and coupled connector and used with ILME standard hoods in die cast aluminum with pegs (without adapter).

Hoods (page 395)



Hoods (page 468 - 469)

C71

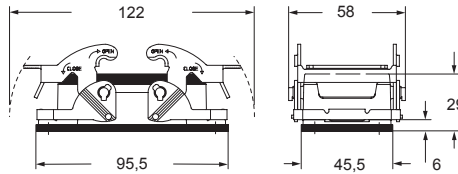

For bulkhead mounting housings, IP66/IP67 degree of protection is guaranteed for mounting on a sufficiently rigid panel; use suitable length M4 screws (negligible surface buckling when subjected to tightening couple on the fixing screws of 0,8 - 1,2 Nm or deformation caused by the weight of the complete connector). In case of insufficient rigidity use of C7.. FL counterflanges (page 443) is recommended, in which case use suitable length M4 screws and M4 (on the enclosure) and M4 (on the counterflange) flat/spring washers with M4 locknut. In addition, the panel surface in contact with the counterflange gasket of the bulkhead mounting housings must be free from defects (deep scratches, grooves, burrs) that could negatively affect the performance of the gasket.

C7P - C7AP and M7P - M7AP

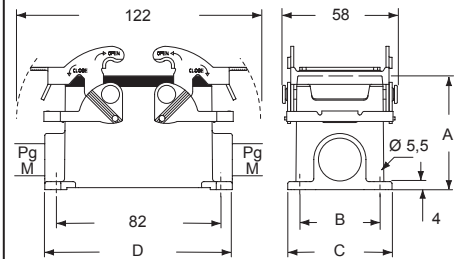

type	A	B	C	D
<b>C7P/M7P 10</b>	57	40	52	93,5
<b>C7AP/M7AP 10</b>	74	45	57	94

**CAUS** Type 4/4X/12



# C7 - C7A and M7 - M7A IP67 enclosures V-TYPE lever version

inserts		page:
CD	40 poles + ⊕	70
CDD	72 poles + ⊕	79
CDS	27 poles + ⊕	-
CDSH	27 poles + ⊕	88
CNE	16 poles + ⊕	112
CSE	16 poles + ⊕	-
CSH	16 poles + ⊕	112
CSH S	16 poles + ⊕	124
CCE	16 poles + ⊕	132
CMSH, CMCE	6+2 (aux) poles + ⊕	138 - 139
CSS	16 poles + ⊕	150
CT, CTS (10A) *)	40 poles + ⊕	156
CT, CTSE (16A) *)	16 poles + ⊕	162
CQE	32 poles + ⊕	170
CQEE	40 poles + ⊕	176
CP	6 poles + ⊕	178
CX	6/12, 6/36 and 12/2 poles + ⊕	197 - 199
CX	4/0 and 4/2 poles + ⊕	200 - 201
MIXO	4 modules	232 - 287

\*) can be used only in bulkhead mounting housings

## bulkhead mounting housings with 2 levers in stainless steel



## surface mounting housings with 2 levers in stainless steel



description	part No.	part No.	entry Pg	part No.	entry M
with levers and gasket, size "77.27"	<b>C71 16</b>				
with levers, size "77.27"		<b>C7P 16</b>	21	<b>M7P 16.25</b>	25
with levers, size "77.27"		<b>C7P 16.2</b>	21 x 2	<b>M7P 16.225</b>	25 x 2
with levers, high construction, size "77.27"		<b>C7AP 16.21</b>	21	<b>M7AP 16.32</b>	32
with levers, high construction, size "77.27"		<b>C7AP 16.221</b>	21 x 2	<b>M7AP 16.232</b>	32 x 2
with levers, high construction, size "77.27"		<b>C7AP 16.29</b>	29	<b>M7AP 16.40</b>	40
with levers, high construction, size "77.27"		<b>C7AP 16.229</b>	29 x 2	<b>M7AP 16.240</b>	40 x 2

### panel cut-out for bulkhead mounting housings

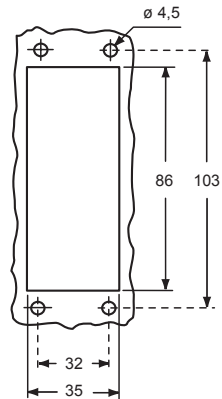

The lever, due to the vertical closing movement, offers an IP66/IP67 degree of protection (according to EN 60529) when fitted with a complete and coupled connector and used with ILME standard hoods in die cast aluminum with pegs (without adapter).

### Hoods (page 404)



### Hoods (page 470 - 471)

### C71

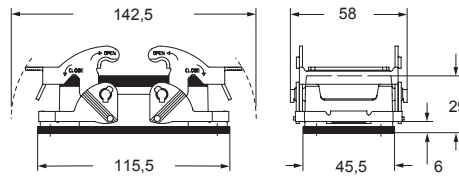

For bulkhead mounting housings, IP66/IP67 degree of protection is guaranteed for mounting on a sufficiently rigid panel; use suitable length M4 screws (negligible surface buckling when subjected to tightening couple on the fixing screws of 0,8 - 1,2 Nm or deformation caused by the weight of the complete connector).

In case of insufficient rigidity use of C7.. FL counterflanges (page 443) is recommended, in which case use suitable length M4 screws and M4 (on the enclosure) and M4 (on the counterflange) flat/spring washers with M4 locknut.

In addition, the panel surface in contact with the counterflange gasket of the bulkhead mounting housings must be free from defects (deep scratches, grooves, burrs) that could negatively affect the performance of the gasket.

### C7P - C7AP and M7P - M7AP

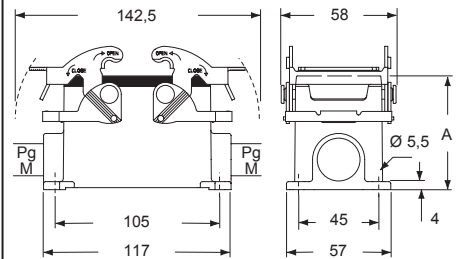

type	A
<b>C7P/M7P 16</b>	63
<b>C7AP/M7AP 16</b>	81

**CAUS** Type 4/4X/12





**C7 and M7A IP67 enclosures V-TYPE lever version**

inserts		page:
CD	40 poles + ⊕	70
CDD	72 poles + ⊕	79
CDS	27 poles + ⊕	-
CDSH	27 poles + ⊕	88
CNE	16 poles + ⊕	112
CSE	16 poles + ⊕	-
CSH	16 poles + ⊕	112
CSH S	16 poles + ⊕	124
CCE	16 poles + ⊕	132
CMSH, CMCE	6+2 (aux) poles + ⊕	138 - 139
CSS	16 poles + ⊕	150
CT, CTS (10A) *)	40 poles + ⊕	156
CT, CTSE (16A) *)	16 poles + ⊕	162
CQE	32 poles + ⊕	170
CQEE	40 poles + ⊕	176
CP	6 poles + ⊕	178
CX	6/12, 6/36 and 12/2 poles + ⊕	197 - 199
CX	4/0 and 4/2 poles + ⊕	200 - 201
MIXO	4 modules	232 - 287

\*) can be used only in bulkhead mounting housings

**bulkhead mounting housings with 2 levers in stainless steel and metal cover**



**surface mounting housings with 2 levers in stainless steel and metal cover**

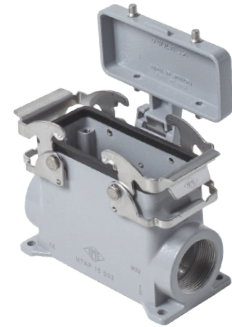

description	part No.	part No.	entry M
with lever, cover and gasket, size "77.27"	<b>C7I 16 S</b>		
with lever and cover, high construction, size "77.27"		<b>M7AP 16 S32</b>	32
with lever and cover, high construction, size "77.27"		<b>M7AP 16 S232</b>	32 x 2

panel cut-out for bulkhead mounting housings

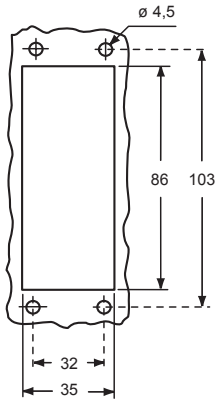

**C7I S**

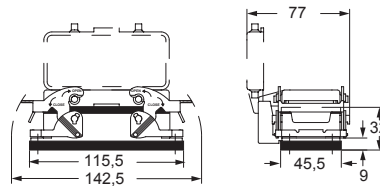

**M7AP S**

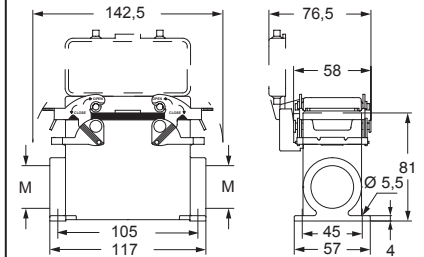

The lever, due to the vertical closing movement, offers an IP66/IP67 degree of protection (according to EN 60529) when fitted with a complete and coupled connector and used with ILME standard hoods in die cast aluminum with pegs (without adapter).

**Hoods (page 404)**



**Hoods (page 470 - 471)**

For bulkhead mounting housings, IP66/IP67 degree of protection is guaranteed for mounting on a sufficiently rigid panel; use suitable length M4 screws (negligible surface buckling when subjected to tightening couple on the fixing screws of 0,8 - 1,2 Nm or deformation caused by the weight of the complete connector). In case of insufficient rigidity use of C7.. FL counterflanges (page 443) is recommended, in which case use suitable length M4 screws and M4 (on the enclosure) and M4 (on the counterflange) flat/spring washers with M4 locknut. In addition, the panel surface in contact with the counterflange gasket of the bulkhead mounting housings must be free from defects (deep scratches, grooves, burrs) that could negatively affect the performance of the gasket.

**CAUS** Type 4/4X/12





# C7 - C7A and M7 - M7A IP67 enclosures V-TYPE lever version

inserts		page:
CD	64 poles + ⊕	72
CDD	108 poles + ⊕	81
CDS	42 poles + ⊕	-
CDSH	42 poles + ⊕	89
CNE	24 poles + ⊕	113
CSE	24 poles + ⊕	-
CSH	24 poles + ⊕	113
CSH S	24 poles + ⊕	125
CCE	24 poles + ⊕	133
CMSH	10+2 (aux) poles + ⊕	140
CMCE	10+2 (aux) poles + ⊕	141
CSS	24 poles + ⊕	151
CT, CTS (10A *)	64 poles + ⊕	157
CT, CTSE (16A *)	24 poles + ⊕	163
CQE	46 poles + ⊕	171
CQEE	64 poles + ⊕	177
CX	4/8 and 6/6 poles + ⊕	204 and 206
MIXO	6 modules	232 - 287

\*) can be used only in bulkhead mounting housings

## bulkhead mounting housings with 2 levers in stainless steel

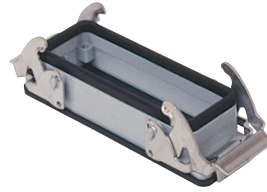

## surface mounting housings with 2 levers in stainless steel



description	part No.	part No.	entry Pg	part No.	entry M
with levers and gasket, size "104.27"	<b>C7I 24</b>				
with levers, size "104.27"		<b>C7P 24</b>	21	<b>M7P 24.25</b>	25
with levers, size "104.27"		<b>C7P 24.2</b>	21 x 2	<b>M7P 24.225</b>	25 x 2
with levers, high construction, size "104.27"		<b>C7AP 24.21</b>	21	<b>M7AP 24.32</b>	32
with levers, high construction, size "104.27"		<b>C7AP 24.221</b>	21 x 2	<b>M7AP 24.232</b>	32 x 2
with levers, high construction, size "104.27"		<b>C7AP 24.29</b>	29	<b>M7AP 24.40</b>	40
with levers, high construction, size "104.27"		<b>C7AP 24.229</b>	29 x 2	<b>M7AP 24.240</b>	40 x 2

### panel cut-out for bulkhead mounting housings

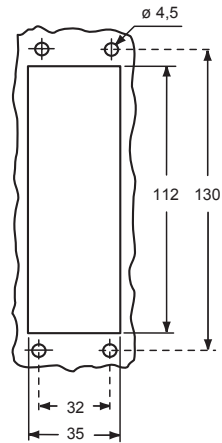

The lever, due to the vertical closing movement, offers an IP66/IP67 degree of protection (according to EN 60529) when fitted with a complete and coupled connector and used with ILME standard hoods in die cast aluminum with pegs (without adapter).

### Hoods (page 414)



### Hoods (page 472 - 473)

### C7I

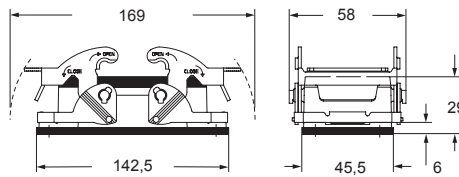

For bulkhead mounting housings, IP66/IP67 degree of protection is guaranteed for mounting on a sufficiently rigid panel; use suitable length M4 screws (negligible surface buckling when subjected to tightening couple on the fixing screws of 0,8 - 1,2 Nm or deformation caused by the weight of the complete connector). In case of insufficient rigidity use of C7.. FL counterflanges (page 443) is recommended, in which case use suitable length M4 screws and M4 (on the enclosure) and M4 (on the counterflange) flat/spring washers with M4 locknut. In addition, the panel surface in contact with the counterflange gasket of the bulkhead mounting housings must be free from defects (deep scratches, grooves, burrs) that could negatively affect the performance of the gasket.

### C7P - C7AP and M7P - M7AP

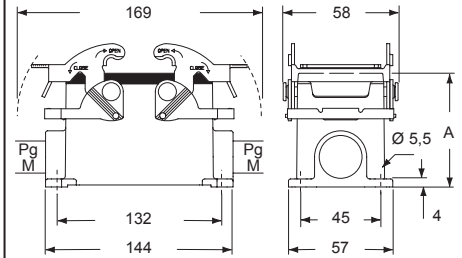

type	A
<b>C7P/M7P 24</b>	63
<b>C7AP/M7AP 24</b>	81

**CAUS**® Type 4/4X/12



# C7 and M7A IP67 enclosures V-TYPE lever version

inserts		page:
CD	64 poles + ⊕	72
CDD	108 poles + ⊕	81
CDS	42 poles + ⊕	-
CDSH	42 poles + ⊕	89
CNE	24 poles + ⊕	113
CSE	24 poles + ⊕	-
CSH	24 poles + ⊕	113
CSH S	24 poles + ⊕	125
CCE	24 poles + ⊕	133
CMSH	10+2 (aux) poles + ⊕	140
CMCE	10+2 (aux) poles + ⊕	141
CSS	24 poles + ⊕	151
CT, CTS (10A) *	64 poles + ⊕	157
CT, CTSE (16A) *	24 poles + ⊕	163
CQE	46 poles + ⊕	171
CQEE	64 poles + ⊕	177
CX	4/8 and 6/6 poles + ⊕	204 and 206
MIXO	6 modules	232 - 287

\*) can be used only in bulkhead mounting housings

## bulkhead mounting housings with 2 levers in stainless steel and metal cover

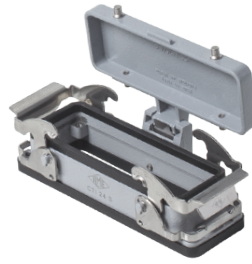

## surface mounting housings with 2 levers in stainless steel and metal cover



description	part No.	part No.	entry
with levers, cover and gasket, size "104.27"	<b>C7I 24 S</b>		
with levers and cover, high construction, size "104.27"		<b>M7AP 24 S32</b>	32
with levers and cover, high construction, size "104.27"		<b>M7AP 24 S232</b>	32 x 2

panel cut-out for bulkhead mounting housings

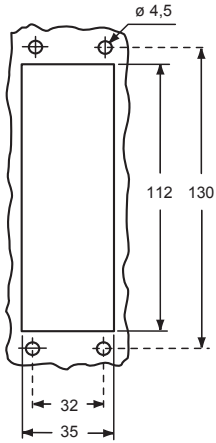

The lever, due to the vertical closing movement, offers an IP66/IP67 degree of protection (according to EN 60529) when fitted with a complete and coupled connector and used with ILME standard hoods in die cast aluminum with pegs (without adapter).

Hoods (page 414)



Hoods (page 472 - 473)

### C7I S

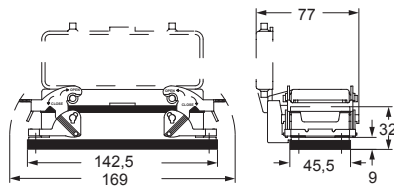

For bulkhead mounting housings, IP66/IP67 degree of protection is guaranteed for mounting on a sufficiently rigid panel; use suitable length M4 screws (negligible surface buckling when subjected to tightening couple on the fixing screws of 0,8 - 1,2 Nm or deformation caused by the weight of the complete connector). In case of insufficient rigidity use of C7.. FL counterflanges (page 443) is recommended, in which case use suitable length M4 screws and M4 (on the enclosure) and M4 (on the counterflange) flat/spring washers with M4 locknut. In addition, the panel surface in contact with the counterflange gasket of the bulkhead mounting housings must be free from defects (deep scratches, grooves, burrs) that could negatively affect the performance of the gasket.

### M7AP S

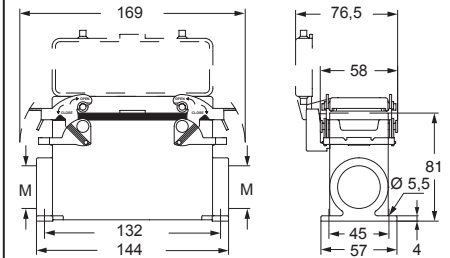

**CAUS** Type 4/4X/12



counterflanges  
for bulkhead mounting housings



description

part No.

size "44.27"  
size "57.27"  
size "77.27"  
size "104.27"

**C7 06 FL**  
**C7 10 FL**  
**C7 16 FL**  
**C7 24 FL**

## C7..FL

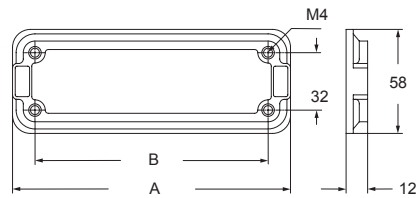

type	A	B
<b>C7 06 FL</b>	95	70
<b>C7 10 FL</b>	108	83
<b>C7 16 FL</b>	128	103
<b>C7 24 FL</b>	155	130

# CV V-TYPE lever version

inserts		page:
CDD	24 poles + ⊕	76
CDS	9 poles + ⊕	-
CDSH	9 poles + ⊕	86
CDSH NC	6 poles + ⊕	95
CNE	6 poles + ⊕	110
CSE	6 poles + ⊕	-
CSH	6 poles + ⊕	110
CSH S	6 poles + ⊕	122
CCE	6 poles + ⊕	130
CSS	6 poles + ⊕	148
CT, CTSE (16A) *	6 poles + ⊕	160
CQE	10 poles + ⊕	168
MIXO	2 modules	232 - 28

\*) can be used only in bulkhead mounting housings

## bulkhead mounting housings with stainless steel single lever

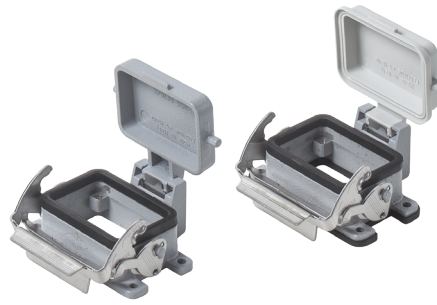

description	part No.
with lever, gasket and cover in aluminium, size "44.27"	<b>CVI 06 LS</b>
with lever, gasket and cover in plastic, size "44.27"	<b>CVI 06 LP</b>

panel cut-out for bulkhead mounting housings

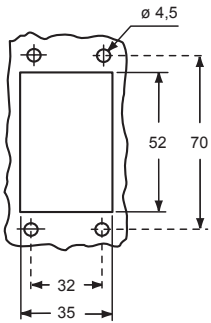

## CVI LS/LP

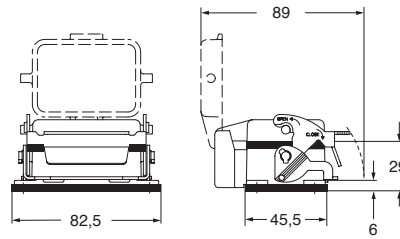

The enclosures ensure IP66 (or IP65 cover versions) degree of protection when mated and locked with the closing levers.

**Hoods**  
(from page 389)



**CAVUS**® Type 4/4X/12  
(except enclosures with plastic cover)



# CV - CVA and MV - MVA V-TYPE lever SIMPLEX self-closing covers

inserts		page:
CDD	24 poles + ⊕	76
CDS	9 poles + ⊕	-
CDSH	9 poles + ⊕	86
CDSH NC	6 poles + ⊕	95
CNE	6 poles + ⊕	110
CSE	6 poles + ⊕	-
CSH	6 poles + ⊕	110
CSH S	6 poles + ⊕	122
CCE	6 poles + ⊕	130
CSS	6 poles + ⊕	148
CT, CTSE (16A) *)	6 poles + ⊕	160
CQE	10 poles + ⊕	168
MIXO	2 modules	232 - 28

\*) can be used only in bulkhead mounting housings

## bulkhead mounting housings with stainless steel single lever



## surface mounting housings with stainless steel single lever



description	part No.	entry Pg	part No.	entry M
with lever, gasket and cover in plastic	<b>CVI 06 LSP</b>			
with lever and cover			<b>CVP 06 LSP16</b> 16	<b>MVP 06 LSP20</b> 20
with lever and cover, high construction			<b>CVAP 06LSP21</b> 21	<b>MVAP 06LSP25</b> 25
with lever and cover, high construction			<b>CVAP 06LSP29</b> 29	<b>MVAP 06LSP32</b> 32
with lever and cover, high construction				<b>MVAP 06LSP40</b> 40

panel cut-out for bulkhead mounting housings

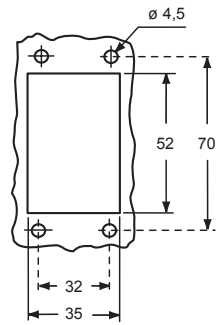

### CVI LSP

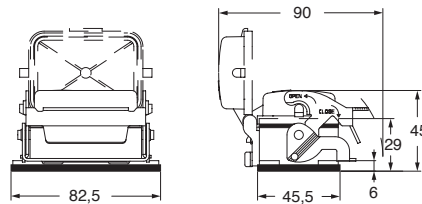

### CVP - CVAP LSP and MVP - MVAP LSP

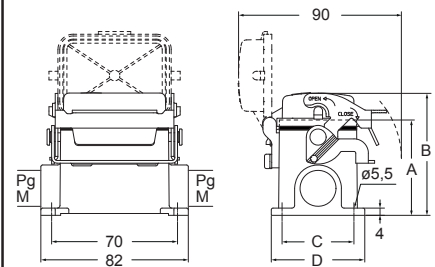

type	A	B	C	D
<b>CVP / MVP 6 LSP</b>	53	68	40	52
<b>CVAP / MVAP 6 LSP</b>	74	89	45	57

☑ The enclosures ensure IP65 degree of protection when mated and locked with the closing lever, or IP44 degree of protection when not mated and locked with lever.

**Hoods**  
(from page 389)



**cURUS** Type 4/4X/12



cURus  
Type 12 / Type 4/4X  
pending



# CV - CVA and MV - MVA V-TYPE lever version

inserts		page:
CDD	24 poles + ⊕	76
CDS	9 poles + ⊕	-
CDSH	9 poles + ⊕	86
CDSH NC	6 poles + ⊕	95
CNE	6 poles + ⊕	110
CSE	6 poles + ⊕	-
CSH	6 poles + ⊕	110
CSH S	6 poles + ⊕	122
CCE	6 poles + ⊕	130
CSS	6 poles + ⊕	148
CQE	10 poles + ⊕	168
MIXO	2 modules	232 - 28

surface mounting housings with stainless steel single lever and plastic cover



surface mounting housings with stainless steel single lever and aluminium cover



description	part No.		entry Pg		part No.		entry M	
with lever and cover, size "44.27"	<b>CVP 06 LP</b>	16	<b>MVP 06 LP20</b>	20	<b>CVP 06 LS</b>	16	<b>MVP 06 LS20</b>	20
with lever and cover, size "44.27"	<b>CVP 06 LP2</b>	16 x 2	<b>MVP 06 LP220</b>	20 x 2	<b>CVP 06 LS2</b>	16 x 2	<b>MVP 06 LS220</b>	20 x 2
with lever and cover, high construction, size "44.27"	<b>CVAP 06 LP</b>	21	<b>MVAP 06 LP32</b>	32	<b>CVAP 06 LS</b>	21	<b>MVAP 06 LS32</b>	32
with lever and cover, high construction, size "44.27"	<b>CVAP 06 LP2</b>	21 x 2	<b>MVAP 06LP232</b>	32 x 2	<b>CVAP 06 LS2</b>	21 x 2	<b>MVAP 06LS232</b>	32 x 2
with lever and cover, high construction, size "44.27"	<b>CVAP 06 LP29</b>	29	<b>MVAP 06 LP40</b>	40	<b>CVAP 06 LS29</b>	29	<b>MVAP 06 LS40</b>	40
with lever and cover, high construction, size "44.27"	<b>CVAP 06LP229</b>	29 x 2	<b>MVAP 06LP240</b>	40 x 2	<b>CVAP 06LS229</b>	29 x 2	<b>MVAP 06LS240</b>	40 x 2

☑ The enclosures ensure IP66 (or IP65 cover versions) degree of protection when mated and locked with the closing levers.

**CVP LP - CVAP LP and MVP LP - MVAP LP**

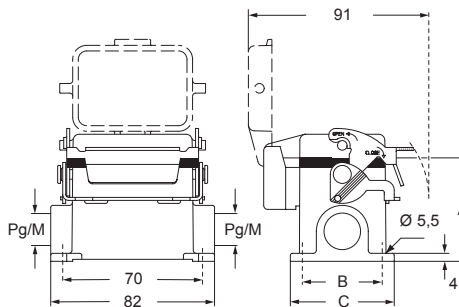

type	A	B	C
<b>CVP/MVP 06 LP</b>	53	40	52
<b>CVAP/MVAP 06 LP</b>	74	45	57

**CVP LS - CVAP LS and MVP LS - MVAP LS**

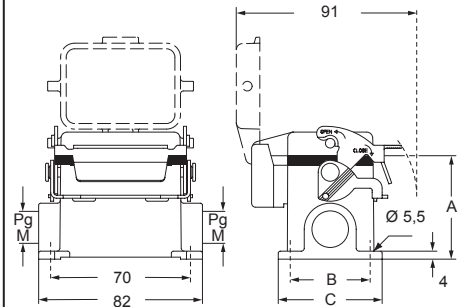

type	A	B	C
<b>CVP/MVP 06 LS</b>	53	40	52
<b>CVAP/MVAP 06 LS</b>	74	45	57

Hoods (from page 389)



**CAUS**® Type 4/4X/12  
(except enclosures with plastic cover)



V-TYPE IP65/IP66



**CV - CVA - CVF MV - MVA - MVF V-TYPE lever version**

inserts		page:
CDD	24 poles + ⊕	76
CDS	9 poles + ⊕	-
CDSH	9 poles + ⊕	86
CDSH NC	6 poles + ⊕	95
CNE	6 poles + ⊕	110
CSE	6 poles + ⊕	-
CSH	6 poles + ⊕	110
CSH S	6 poles + ⊕	122
CCE	6 poles + ⊕	130
CSS	6 poles + ⊕	148
CQE	10 poles + ⊕	168
MIXO	2 modules	232 - 28

**hoods, top entry  
with gasket and stainless steel single lever**



description	part No.	entry Pg	part No	entry M
with lever, size "44.27"	<b>CVV 06 LG</b>	16	<b>MVV 06 LG25</b>	25
with lever, high construction, size "44.27"	<b>CVAV 06 LG21</b>	21	<b>MVAV 06 LG25</b>	25
with lever, high construction, size "44.27"	<b>CVAV 06 LG29</b>	29	<b>MVAV 06 LG32</b>	32
with lever, high construction, without adapter, size "44.27"	<b>CVFV 06 LG21</b>	21	<b>MVFV 06 LG25</b>	25
with lever, high construction, without adapter, size "44.27"	<b>CVFV 06 LG29</b>	29	<b>MVFV 06 LG32</b>	32

**CVV LG - CVAV LG - CVFV LG and  
MVV LG - MVAV LG - MVFV LG**

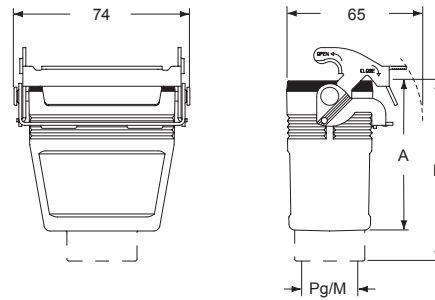

type	A	B
<b>CVV/MVV 06 LG</b>	45,5	58,5
<b>CVAV/MVAV 06 LG</b>	77	93
<b>CVFV/MVFV 06 LG</b>	77	-

**Hoods**  
(from page 389)



**CRUS** Type  
4/4X/12



# CV V-TYPE lever version

inserts		page:
CDD	42 poles + ⊕	78
CDS	18 poles + ⊕	-
CDSH	18 poles + ⊕	87
CNE	10 poles + ⊕	111
CSE	10 poles + ⊕	-
CSH	10 poles + ⊕	111
CSH S	10 poles + ⊕	123
CCE	10 poles + ⊕	131
CMSH	3+2 (aux) poles + ⊕	136
CMCE	3+2 (aux) poles + ⊕	137
CSS	10 poles + ⊕	149
CT, CTSE (16A) *)	10 poles + ⊕	161
CQE	18 poles + ⊕	169
CX	8/24 poles + ⊕	194
MIXO	3 modules	232 - 287

\*) can be used only in bulkhead mounting housings

## bulkhead mounting housings with single lever in stainless steel



## bulkhead mounting housings with single lever in stainless steel

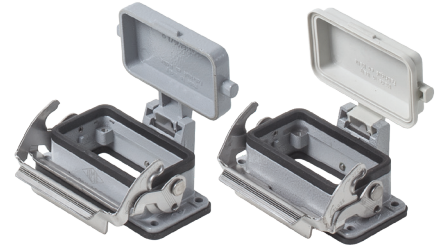

description	part No.	part No.
with lever and gasket, size "57.27"	<b>CVI 10 L</b>	
with lever, gasket and cover in aluminium, size "57.27"		<b>CVI 10 LS</b>
with lever, gasket and cover in plastic, size "57.27"		<b>CVI 10 LP</b>

panel cut-out for bulkhead mounting housings

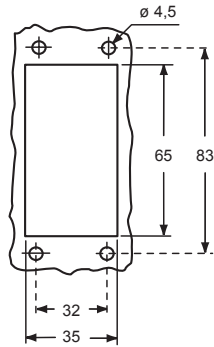

### CVI L

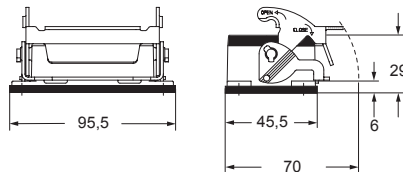

### CVI LS/LP

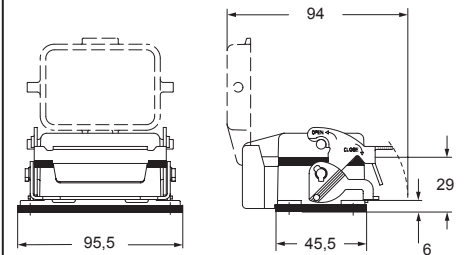

☑ The enclosures ensure IP66 (or IP65 cover versions) degree of protection when mated and locked with the closing levers.

Hoods  
(from page 395)



**CAVUS**® Type 4/4X/12  
(except enclosures with plastic cover)



# CV - CVA and MV - MVA V-TYPE lever SIMPLEX self-closing covers

inserts		page:
CDD	42 poles + ⊕	78
CDS	18 poles + ⊕	-
CDSH	18 poles + ⊕	87
CNE	10 poles + ⊕	111
CSE	10 poles + ⊕	-
CSH	10 poles + ⊕	111
CSH S	10 poles + ⊕	123
CCE	10 poles + ⊕	131
CMSH	3+2 (aux) poles + ⊕	136
CMCE	3+2 (aux) poles + ⊕	137
CSS	10 poles + ⊕	149
CT, CTSE (16A) *)	10 poles + ⊕	161
CQE	18 poles + ⊕	169
CX	8/24 poles + ⊕	194
MIXO	3 modules	232 - 287

\*) can be used only in bulkhead mounting housings

## bulkhead mounting housings with stainless steel single lever



## surface mounting housings with stainless steel single lever



description	part No.	entry Pg	part No.	entry M
with lever, gasket and cover in plastic	<b>CVI 10 LSP</b>			
with lever and cover			<b>CVP 10 LSP16</b> 16	<b>MVP 10 LSP20</b> 20
with lever and cover, high construction			<b>CVAP 10LSP21</b> 21	<b>MVAP 10LSP25</b> 25
with lever and cover, high construction			<b>CVAP 10LSP29</b> 29	<b>MVAP 10LSP32</b> 32
with lever and cover, high construction				<b>MVAP 10LSP40</b> 40

### panel cut-out for bulkhead mounting housings

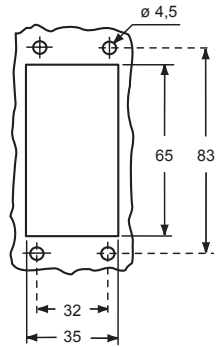

☑ The enclosures ensure IP65 degree of protection when mated and locked with the closing lever, or IP44 degree of protection when not mated and locked with lever.

**Hoods**  
(from page 395)



### CVI LSP

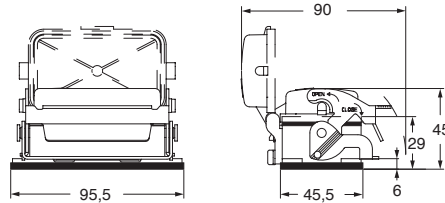

### CVP - CVAP LSP and MVP - MVAP LSP

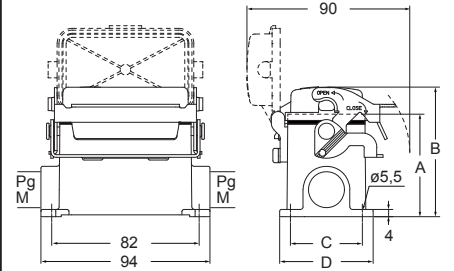

type	A	B	C	D
<b>CVP / MVP 10 LSP</b>	57	72	40	52
<b>CVAP / MVAP 10 LSP</b>	74	89	45	57

**cURus**® Type 4/4X/12



cURus  
Type 12 / Type 4/4X  
pending



# CV and MV V-TYPE lever version

inserts		page:
CDD	42 poles + ⊕	78
CDS	18 poles + ⊕	-
CDSH	18 poles + ⊕	87
CNE	10 poles + ⊕	111
CSE	10 poles + ⊕	-
CSH	10 poles + ⊕	111
CSH S	10 poles + ⊕	123
CCE	10 poles + ⊕	131
CMSH	3+2 (aux) poles + ⊕	136
CMCE	3+2 (aux) poles + ⊕	137
CSS	10 poles + ⊕	149
CQE	18 poles + ⊕	169
CX	8/24 poles + ⊕	194
MIXO	3 modules	232 - 287

## angled bulkhead mounting housings with stainless steel single lever



## angled bulkhead mounting housings with stainless steel single lever



description	part No.	entry M	part No.	entry M
-------------	----------	---------	----------	---------

with lever, without cable gland entry <sup>1) 3)</sup> **CVI 10 LA** 32

with lever, with cable gland entry, closed bulkhead <sup>2)</sup> **MVI 10 LAP32** 32

<sup>1)</sup> Flange gasket to be purchased separately.  
part No.: **CR 10 MO**.

**CR 10 MO**  
gasket

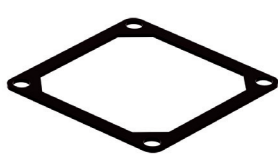

Following flange versions available on request:  
73 x 73, 78 x 78, 80 x 80, 98 x 98 mm

- <sup>2)</sup> Be used only with a complete cable gland (to be purchased separately).  
Versions with M 25 or Pg 21 entry on request.
- <sup>3)</sup> Kit with earthing contact, comprising a special screw and wire-terminals for 6 mm<sup>2</sup> earthing conductors (for the additional connection of the upper enclosure half) part No.: **CR MOT**.

**CR MOT**



The enclosures ensure IP65 degree of protection when mated and locked with the closing lever.

**Hoods**  
(from page 395)



**CAUS**® Type 4/4X/12

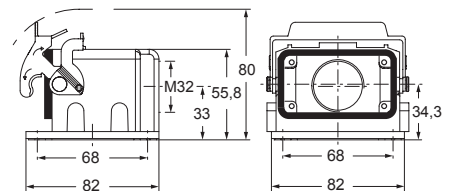
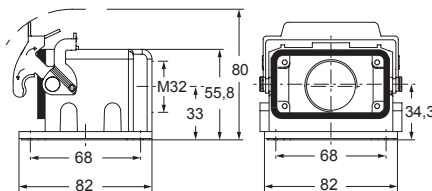

# CV - CVA and MV - MVA V-TYPE lever version

inserts		page:
CDD	42 poles + ⊕	78
CDS	18 poles + ⊕	-
CDSH	18 poles + ⊕	87
CNE	10 poles + ⊕	111
CSE	10 poles + ⊕	-
CSH	10 poles + ⊕	111
CSH S	10 poles + ⊕	123
CCE	10 poles + ⊕	131
CMSH	3+2 (aux) poles + ⊕	136
CMCE	3+2 (aux) poles + ⊕	137
CSS	10 poles + ⊕	149
CQE	18 poles + ⊕	169
CX	8/24 poles + ⊕	194
MIXO	3 modules	232 - 287

## surface mounting housings with single lever in stainless steel

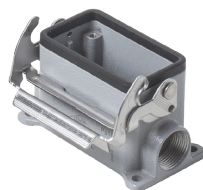

description	part No.	entry Pg	part No	entry M
with lever/s, size "57.27"	<b>CVP 10 L</b>	16	<b>MVP 10 L20</b>	20
with lever/s, size "57.27"	<b>CVP 10 L2</b>	16 x 2	<b>MVP 10 L220</b>	20 x 2
with lever/s, high construction, size "57.27"	<b>CVAP 10 L21</b>	21	<b>MVAP 10 L32</b>	32
with lever/s, high construction, size "57.27"	<b>CVAP 10 L221</b>	21 x 2	<b>MVAP 10 L232</b>	32 x 2
with lever/s, high construction, size "57.27"	<b>CVAP 10 L29</b>	29	<b>MVAP 10 L40</b>	40
with lever/s, high construction, size "57.27"	<b>CVAP 10 L229</b>	29 x 2	<b>MVAP 10 L240</b>	40 x 2

### CVL L - CVAP L and MVP L - MVAP L

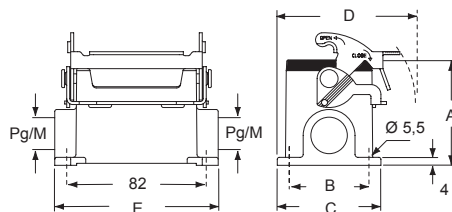

type	A	B	C	D	E
<b>CVP/MVP 10 L</b>	57	40	52	73	93,5
<b>CVAP/MVAP 10 L</b>	74	45	57	75,5	94

Hoods  
(from page 395)



**CUUS**® Type 4/4X/12



V-TYPE IP65/IP66

# CV - CVA and MV - MVA V-TYPE lever version

inserts		page:
CDD	42 poles + ⊕	78
CDS	18 poles + ⊕	-
CDSH	18 poles + ⊕	87
CNE	10 poles + ⊕	111
CSE	10 poles + ⊕	-
CSH	10 poles + ⊕	111
CSH S	10 poles + ⊕	123
CCE	10 poles + ⊕	131
CMSH	3+2 (aux) poles + ⊕	136
CMCE	3+2 (aux) poles + ⊕	137
CSS	10 poles + ⊕	149
CQE	18 poles + ⊕	169
CX	8/24 poles + ⊕	194
MIXO	3 modules	232 - 287

## surface mounting housings with stainless steel single lever and plastic cover



## surface mounting housings with stainless steel single lever and aluminium cover

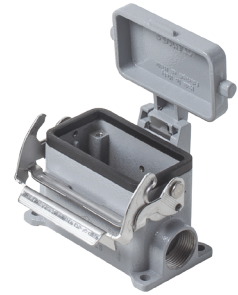

description	part No.	entry Pg	part No	entry M	part No.	entry Pg	part No.	entry M
with lever and cover, size "57.27"	<b>CVP 10 LP</b>	16	<b>MVP 10 LP20</b>	20	<b>CVP 10 LS</b>	16	<b>MVP 10 LS20</b>	20
with lever and cover, size "57.27"	<b>CVP 10 LP2</b>	16 x 2	<b>MVP 10 LP220</b>	20 x 2	<b>CVP 10 LS2</b>	16 x 2	<b>MVP 10 LS220</b>	20 x 2
with lever and cover, high construction, size "57.27"	<b>CVAP 10 LP21</b>	21	<b>MVAP 10 LP32</b>	32	<b>CVAP 10 LS</b>	21	<b>MVAP 10 LS32</b>	32
with lever and cover, high construction, size "57.27"	<b>CVAP 10LP221</b>	21 x 2	<b>MVAP 10LP232</b>	32 x 2	<b>CVAP 10 LS2</b>	21 x 2	<b>MVAP 10LS232</b>	32 x 2
with lever and cover, high construction, size "57.27"	<b>CVAP 10 LP29</b>	29	<b>MVAP 10 LP40</b>	40	<b>CVAP 10 LS29</b>	29	<b>MVAP 10 LS40</b>	40
with lever and cover, high construction, size "57.27"	<b>CVAP 10LP229</b>	29 x 2	<b>MVAP 10LP240</b>	40 x 2	<b>CVAP 10LS229</b>	29 x 2	<b>MVAP 10LS240</b>	40 x 2

☑ The enclosures ensure IP66 (or IP65 cover versions) degree of protection when mated and locked with the closing levers.

### CVP LP - CVAP LP and MVP LP - MVAP LP

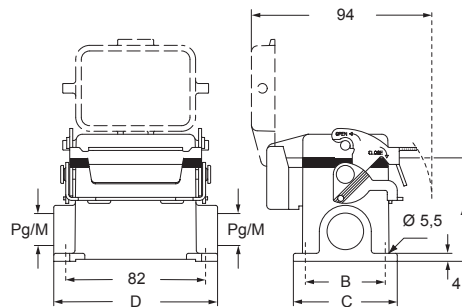

type	A	B	C	D
<b>CVP/MVP 10 LP</b>	57	40	52	93,5
<b>CVAP/MVAP 10 LP</b>	74	45	57	94

### CVP LS - CVAP LS and MVP LS - MVAP LS

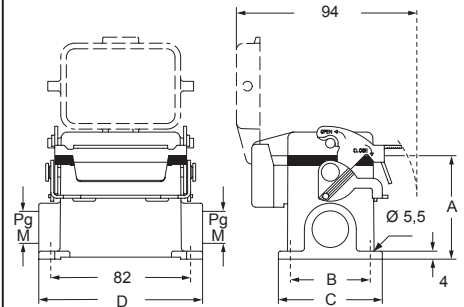

type	A	B	C	D
<b>CVP/MVP 10 LS</b>	57	40	52	93,5
<b>CVAP/MVAP 10 LS</b>	74	45	57	94

Hoods  
(from page 395)



**CAUS**® Type 4/4X/12  
(except enclosures with plastic cover)



V-TYPE IP65/IP66



**CV - CVA - CVF MV - MVA - MVF V-TYPE lever version**

inserts		page:
CDD	42 poles + ⊕	78
CDS	18 poles + ⊕	-
CDSH	18 poles + ⊕	87
CNE	10 poles + ⊕	111
CSE	10 poles + ⊕	-
CSH	10 poles + ⊕	111
CSH S	10 poles + ⊕	123
CCE	10 poles + ⊕	131
CMSH	3+2 (aux) poles + ⊕	136
CMCE	3+2 (aux) poles + ⊕	137
CSS	10 poles + ⊕	149
CQE	18 poles + ⊕	169
CX	8/24 poles + ⊕	194
MIXO	3 modules	232 - 287

**hoods, top entry,  
with gasket and stainless steel single lever**



**hoods, top entry,  
with gasket and 2 levers in stainless steel**



description	part No.	entry Pg	part No.	entry M	part No.	entry Pg	part No.	entry M
with lever/s, size "57.27"	<b>CVV 10 LG</b>	16	<b>MVV 10 LG25</b>	25	<b>CVV 10 G</b>	16	<b>MVV 10 G25</b>	25
with lever/s, high construction, size "57.27"	<b>CVAV 10 LG21</b>	21	<b>MVAV 10 LG25</b>	25	<b>CVAV 10 G21</b>	21	<b>MVAV 10 G25</b>	25
with lever/s, high construction, size "57.27"	<b>CVAV 10 LG29</b>	29	<b>MVAV 10 LG32</b>	32	<b>CVAV 10 G29</b>	29	<b>MVAV 10 G32</b>	32
with lever, high construction, without adapter, size "57.27"	<b>CVFV 10 LG21</b>	21	<b>MVFV 10 LG25</b>	25	<b>CVFV 10 G21</b>	21	<b>MVFV 10 G25</b>	25
with lever, high construction, without adapter, size "57.27"	<b>CVFV 10 LG29</b>	29	<b>MVFV 10 LG32</b>	32	<b>CVFV 10 G29</b>	29	<b>MVFV 10 G32</b>	32

**CVV LG - CVAV LG - CVFV LG and  
MVV LG - MVAV LG - MVFV LG**

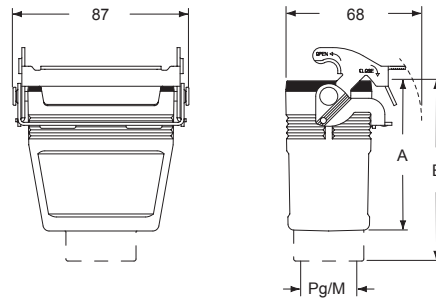

type	A	B
<b>CVV/MVV 10 LG</b>	50,5	63,5
<b>CVAV/MVAV 10 LG</b>	75	91
<b>CVFV/MVFV 10 LG</b>	75	-

**CVV G - CVAV G - CVFV G and  
MVV G - MVAV G - MVFV G**

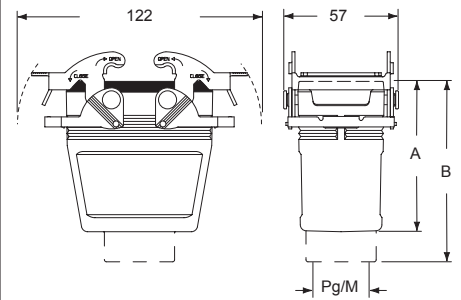

type	A	B
<b>CVV/MVV 10 G</b>	50,5	63,5
<b>CVAV/MVAV 10 G</b>	75	91
<b>CVFV/MVFV 10 G</b>	75	-

**Hoods**  
(from page 395)



**CAUS** Type  
4/4X/12



# CV V-TYPE lever version

inserts		page:
CD	40 poles + ⊕	70
CDD	72 poles + ⊕	79
CDS	27 poles + ⊕	-
CDSH	27 poles + ⊕	88
CNE	16 poles + ⊕	112
CSE	16 poles + ⊕	-
CSH	16 poles + ⊕	112
CSH S	16 poles + ⊕	124
CCE	16 poles + ⊕	132
CMSH, CMCE	6+2 (aux) poles + ⊕	138 - 139
CSS	16 poles + ⊕	150
CT, CTS (10A) *)	40 poles + ⊕	156
CT, CTSE (16A) *)	16 poles + ⊕	162
CQE	32 poles + ⊕	170
CQEE	40 poles + ⊕	176
CP	6 poles + ⊕	178
CX	6/12, 6/36 and 12/2 poles + ⊕	197 - 199
CX	4/0 and 4/2 poles + ⊕	200 - 201
MIXO	4 modules	232 - 287

\*) can be used only in bulkhead mounting housings

## bulkhead mounting housings with single lever in stainless steel

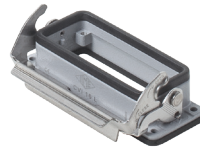

## bulkhead mounting housings with single lever in stainless steel



description	part No.	part No.
with lever and gasket, size "77.27"	<b>CVI 16 L</b>	
with lever, gasket and cover in aluminium, size "77.27"		<b>CVI 16 LS</b>
with lever, gasket and cover in plastic, size "77.27"		<b>CVI 16 LP</b>

panel cut-out for bulkhead mounting housings

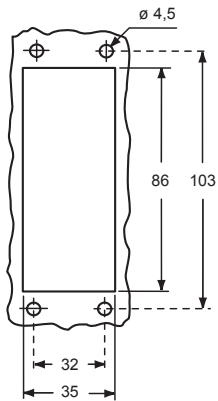

### CVI L

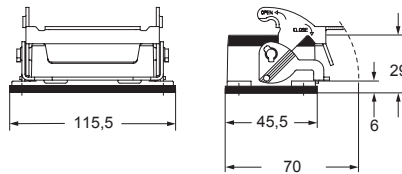

### CVI LS/LP

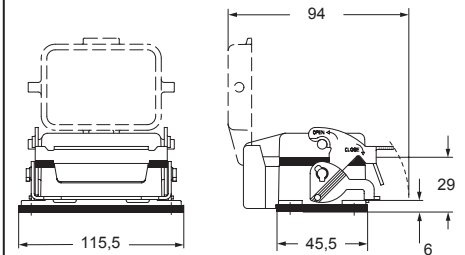

☑ The enclosures ensure IP66 (or IP65 cover versions) degree of protection when mated and locked with the closing levers.

**Hoods**  
(from page 404)



**CAVUS**® Type 4/4X/12  
(except enclosures with plastic cover)



V-TYPE IP65/IP66

# CV - CVA and MV - MVA V-TYPE lever SIMPLEX self-closing covers

inserts		page:
CD	40 poles + ⊕	70
CDD	72 poles + ⊕	79
CDS	27 poles + ⊕	-
CDSH	27 poles + ⊕	88
CNE	16 poles + ⊕	112
CSE	16 poles + ⊕	-
CSH	16 poles + ⊕	112
CSH S	16 poles + ⊕	124
CCE	16 poles + ⊕	132
CMSH, CMCE	6+2 (aux) poles + ⊕	138 - 139
CSS	16 poles + ⊕	150
CT, CTS (10A *)	40 poles + ⊕	156
CT, CTSE (16A *)	16 poles + ⊕	162
CQE	32 poles + ⊕	170
CQEE	40 poles + ⊕	176
CP	6 poles + ⊕	178
CX	6/12, 6/36 and 12/2 poles + ⊕	197 - 199
CX	4/0 and 4/2 poles + ⊕	200 - 201
MIXO	4 modules	232 - 287

\*) can be used only in bulkhead mounting housings

## bulkhead mounting housings with stainless steel single lever



## surface mounting housings with stainless steel single lever



description	part No.	entry Pg	part No.	entry M
with lever, gasket and cover in plastic	<b>CVI 16 LSP</b>			
with lever and cover			<b>CVP 16 LSP21</b> 21	<b>MVP 16 LSP25</b> 25
with lever and cover, high construction			<b>CVAP 16LSP21</b> 21	<b>MVAP 16LSP25</b> 25
with lever and cover, high construction			<b>CVAP 16LSP29</b> 29	<b>MVAP 16LSP32</b> 32
with lever and cover, high construction				<b>MVAP 16LSP40</b> 40

### panel cut-out for bulkhead mounting housings

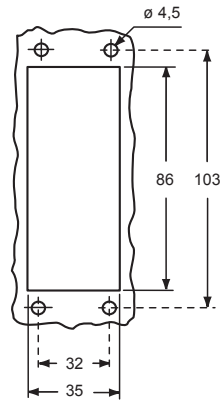

☑ The enclosures ensure IP65 degree of protection when mated and locked with the closing lever, or IP44 degree of protection when not mated and locked with lever.

**Hoods**  
(from page 404)



### CVI LSP

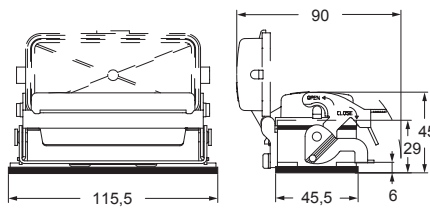

### CVP - CVAP LSP and MVP - MVAP LSP

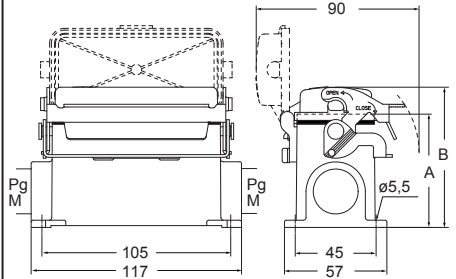

part No.	A	B
<b>CVP / MVP 16 LSP</b>	63	78
<b>CVAP / MVAP 16 LSP</b>	81	96

**cRU<sup>®</sup>US** Type 4/4X/12



cURus  
Type 12 / Type 4/4X  
pending



# CV - CVA and MV - MVA V-TYPE lever version

inserts		page:
CD	40 poles + ⊕	70
CDD	72 poles + ⊕	79
CDS	27 poles + ⊕	-
CDSH	27 poles + ⊕	88
CNE	16 poles + ⊕	112
CSE	16 poles + ⊕	-
CSH	16 poles + ⊕	112
CSH S	16 poles + ⊕	124
CCE	16 poles + ⊕	132
CMSH, CMCE	6+2 (aux) poles + ⊕	138 - 139
CSS	16 poles + ⊕	150
CQE	32 poles + ⊕	170
CQEE	40 poles + ⊕	176
CP	6 poles + ⊕	178
CX	6/12, 6/36 and 12/2 poles + ⊕	197 - 199
CX	4/0 and 4/2 poles + ⊕	200 - 201
MIXO	4 modules	232 - 287

## surface mounting housings with single lever in stainless steel



description	part No.	entry Pg	part No	entry M
with lever/s, size "77.27"	<b>CVP 16 L</b>	21	<b>MVP 16 L25</b>	25
with lever/s, size "77.27"	<b>CVP 16 L2</b>	21 x 2	<b>MVP 16 L225</b>	25 x 2
with lever/s, high construction, size "77.27"	<b>CVAP 16 L21</b>	21	<b>MVAP 16 L32</b>	32
with lever/s, high construction, size "77.27"	<b>CVAP 16 L221</b>	21 x 2	<b>MVAP 16 L232</b>	32 x 2
with lever/s, high construction, size "77.27"	<b>CVAP 16 L29</b>	29	<b>MVAP 16 L40</b>	40
with lever/s, high construction, size "77.27"	<b>CVAP 16 L229</b>	29 x 2	<b>MVAP 16 L240</b>	40 x 2

### CVP L - CVAP L and MVP L - MVAP L

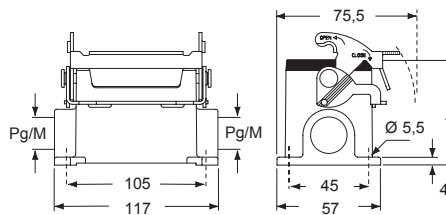

type	A
<b>CVP/MVP 16 L</b>	63
<b>CVAP/MVAP 16 L</b>	81

Hoods  
(from page 404)



**CAUS**® Type 4/4X/12



# CV - CVA and MV - MVA V-TYPE lever version

inserts		page:
CD	40 poles + ⊕	70
CDD	72 poles + ⊕	79
CDS	27 poles + ⊕	-
CDSH	27 poles + ⊕	88
CNE	16 poles + ⊕	112
CSE	16 poles + ⊕	-
CSH	16 poles + ⊕	112
CSH S	16 poles + ⊕	124
CCE	16 poles + ⊕	132
CMSH, CMCE	6+2 (aux) poles + ⊕	138 - 139
CSS	16 poles + ⊕	150
CQE	32 poles + ⊕	170
CQEE	40 poles + ⊕	176
CP	6 poles + ⊕	178
CX	6/12, 6/36 and 12/2 poles + ⊕	197 - 199
CX	4/0 and 4/2 poles + ⊕	200 - 201
MIXO	4 modules	232 - 287

surface mounting housings with single lever in stainless steel and plastic cover

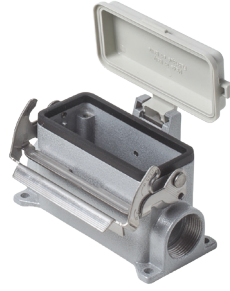

surface mounting housings with single lever in stainless steel and aluminium cover

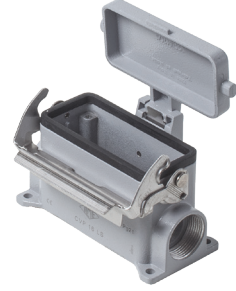

description	part No.	entry Pg	part No.	entry M	part No.	entry Pg	part No.	entry M
with lever and cover, size "77.27"	<b>CVP 16 LP</b>	21	<b>MVP 16 LP25</b>	25	<b>CVP 16 LS</b>	21	<b>MVP 16 LS25</b>	25
with lever and cover, size "77.27"	<b>CVP 16 LP2</b>	21 x 2	<b>MVP 16 LP225</b>	25 x 2	<b>CVP 16 LS2</b>	21 x 2	<b>MVP 16 LS225</b>	25 x 2
with lever and cover, high construction, size "77.27"	<b>CVAP 16 LP21</b>	21	<b>MVAP 16 LP32</b>	32	<b>CVAP 16 LS</b>	21	<b>MVAP 16 LS32</b>	32
with lever and cover, high construction, size "77.27"	<b>CVAP 16LP221</b>	21 x 2	<b>MVAP 16LP232</b>	32 x 2	<b>CVAP 16 LS2</b>	21 x 2	<b>MVAP 16LS232</b>	32 x 2
with lever and cover, high construction, size "77.27"	<b>CVAP 16 LP29</b>	29	<b>MVAP 16 LP40</b>	40	<b>CVAP 16 LS29</b>	29	<b>MVAP 16 LS40</b>	40
with lever and cover, high construction, size "77.27"	<b>CVAP 16LP229</b>	29 x 2	<b>MVAP 16LP240</b>	40 x 2	<b>CVAP 16LS229</b>	29 x 2	<b>MVAP 16LS240</b>	40 x 2

☑ The enclosures ensure IP66 (or IP65 cover versions) degree of protection when mated and locked with the closing levers.

**CVLP LP - CVAP LP and MVP LP - MVAP LP**

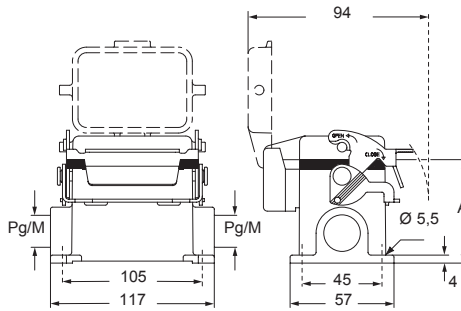

type	A
<b>CVP/MVP 16 LP</b>	63
<b>CVAP/MVAP 16 LP</b>	81

**CVLP LS - CVAP LS and MVP LS - MVAP LS**

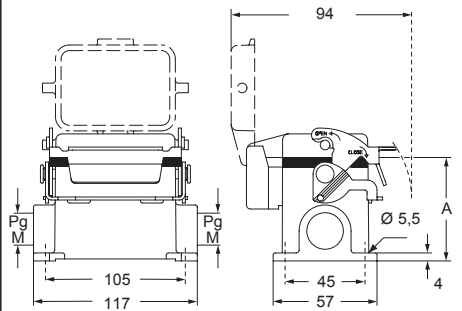

type	A
<b>CVP/MVP 16 LS</b>	63
<b>CVAP/MVAP 16 LS</b>	81

**Hoods**  
(from page 404)



**CRUS**® Type 4/4X/12  
(except enclosures with plastic cover)



**CV - CVA - CVF MV - MVA - MVF V-TYPE lever version**

inserts		page:
CD	40 poles + ⊕	70
CDD	72 poles + ⊕	79
CDS	27 poles + ⊕	-
CDSH	27 poles + ⊕	88
CNE	16 poles + ⊕	112
CSE	16 poles + ⊕	-
CSH	16 poles + ⊕	112
CSH S	16 poles + ⊕	124
CCE	16 poles + ⊕	132
CMSH, CMCE	6+2 (aux) poles + ⊕	138 - 139
CSS	16 poles + ⊕	150
CQE	32 poles + ⊕	170
CQEE	40 poles + ⊕	176
CP	6 poles + ⊕	178
CX	6/12, 6/36 and 12/2 poles + ⊕	197 - 199
CX	4/0 and 4/2 poles + ⊕	200 - 201
MIXO	4 modules	232 - 287

**hoods, top entry,  
with gasket and single lever in stainless steel**



**hoods, top entry,  
with gasket and 2 levers in stainless steel**



description	part No.		entry		part No.		entry	
		Pg		M		Pg		M
with lever/s, size "77.27"	<b>CVV 16 LG</b>	21	<b>MVV 16 LG32</b>	32	<b>CVV 16 G</b>	21	<b>MVV 16 G32</b>	32
with lever/s, high construction, size "77.27"	<b>CVAV 16 LG21</b>	21	<b>MVAV 16 LG25</b>	25	<b>CVAV 16 G21</b>	21	<b>MVAV 16 G25</b>	25
with lever/s, high construction, size "77.27"	<b>CVAV 16 LG29</b>	29	<b>MVAV 16 LG32</b>	32	<b>CVAV 16 G29</b>	29	<b>MVAV 16 G32</b>	32
with lever, high construction, without adapter, size "77.27"	<b>CVFV 16 LG21</b>	21	<b>MVFV 16 LG25</b>	25	<b>CVFV 16 G21</b>	21	<b>MVFV 16 G25</b>	25
with lever, high construction, without adapter, size "77.27"	<b>CVFV 16 LG29</b>	29	<b>MVFV 16 LG32</b>	32	<b>CVFV 16 G29</b>	29	<b>MVFV 16 G32</b>	32

☑ The enclosures ensure IP66 (or IP65 cover versions) degree of protection when mated and locked with the closing levers.

**CVV LG - CVAV LG - CVFV LG and  
MVV LG - MVAV LG - MVFV LG**

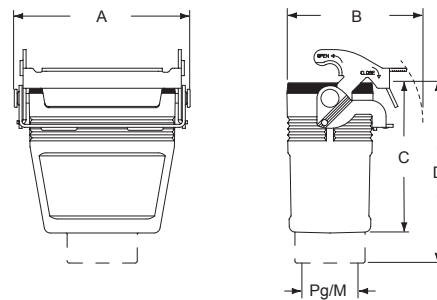

type	A	B	C	D
<b>CVV/MVV 16 LG</b>	107,5	68	50,5	63,5
<b>CVAV/MVAV 16 LG</b>	107,5	68	81	97
<b>CVFV/MVFV 16 LG</b>	107,5	68	81	-

**CVV G - CVAV G - CVFV G and  
MVV G - MVAV G - MVFV G**

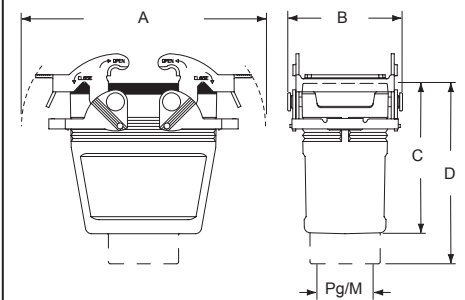

type	A	B	C	D
<b>CVV/MVV 16 G</b>	142,5	57	50,5	63,5
<b>CVAV/MVAV 16 G</b>	142,5	57	81	97
<b>CVFV/MVFV 16 G</b>	142,5	57	81	-

**Hoods**  
(from page 404)



**CAUS**® Type  
4/4X/12



V-TYPE IP65/IP66



# CV V-TYPE lever version

inserts		page:
CD	64 poles + ⊕	72
CDD	108 poles + ⊕	81
CDS	42 poles + ⊕	-
CDSH	42 poles + ⊕	89
CNE	24 poles + ⊕	113
CSE	24 poles + ⊕	-
CSH	24 poles + ⊕	113
CSH S	24 poles + ⊕	125
CCE	24 poles + ⊕	133
CMSH	10+2 (aux) poles + ⊕	140
CMCE	10+2 (aux) poles + ⊕	141
CSS	24 poles + ⊕	151
CT, CTS (10A *)	64 poles + ⊕	157
CT, CTSE (16A *)	24 poles + ⊕	163
CQE	46 poles + ⊕	171
CQEE	64 poles + ⊕	177
CX	4/8 and 6/6 poles + ⊕	204 and 206
MIXO	6 modules	232 - 287

\*) can be used only in bulkhead mounting housings

## bulkhead mounting housings with single lever in stainless steel

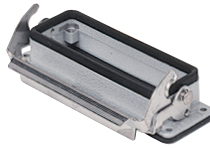

## bulkhead mounting housings with single lever in stainless steel



description	part No.	part No.
with lever and gasket, size "104.27"	<b>CVI 24 L</b>	
with lever, gasket and cover in aluminium, size "104.27"		<b>CVI 24 LS</b>
with lever, gasket and cover in plastic, size "104.27"		<b>CVI 24 LP</b>

panel cut-out for bulkhead mounting housings

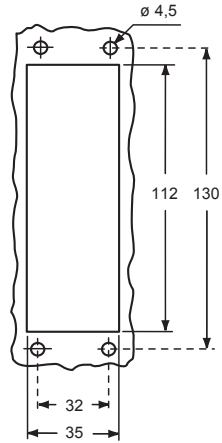

**CVI L**

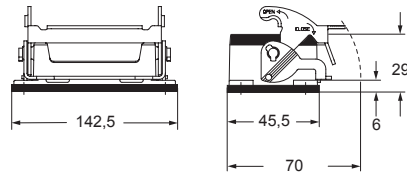

**CVI LS/LP**

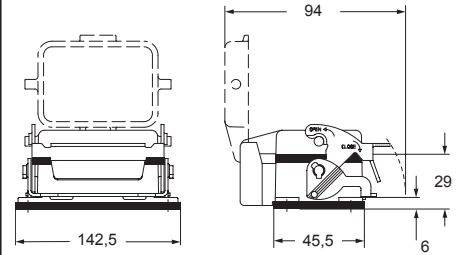

The enclosures ensure IP66 (or IP65 cover versions) degree of protection when mated and locked with the closing levers.

**Hoods**  
(from page 414)



**CAVUS**® Type 4/4X/12  
(except enclosures with plastic cover)



**CV - CVA and MV - MVA V-TYPE lever SIMPLEX self-closing covers**

inserts		page:
CD	64 poles + ⊕	72
CDD	108 poles + ⊕	81
CDS	42 poles + ⊕	-
CDSH	42 poles + ⊕	89
CNE	24 poles + ⊕	113
CSE	24 poles + ⊕	-
CSH	24 poles + ⊕	113
CSH S	24 poles + ⊕	125
CCE	24 poles + ⊕	133
CMSH	10+2 (aux) poles + ⊕	140
CMCE	10+2 (aux) poles + ⊕	141
CSS	24 poles + ⊕	151
CT, CTS (10A) *	64 poles + ⊕	157
CT, CTSE (16A) *	24 poles + ⊕	163
CQE	46 poles + ⊕	171
CQEE	64 poles + ⊕	177
CX	4/8 and 6/6 poles + ⊕	204 and 206
MIXO	6 modules	232 - 287

\*) can be used only in bulkhead mounting housings

**bulkhead mounting housings with stainless steel single lever**



**surface mounting housings with stainless steel single lever**

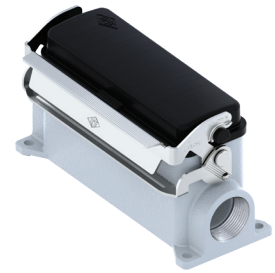

description	part No.	part No.	entry Pg	part No.	entry M
with lever, gasket and cover in plastic	<b>CVI 24 LSP</b>				
with lever and cover		<b>CVP 24 LSP21</b>	21	<b>MVP 24 LSP25</b>	25
with lever and cover, high construction		<b>CVAP 24LSP21</b>	21	<b>MVAP 24LSP25</b>	25
with lever and cover, high construction		<b>CVAP 24LSP29</b>	29	<b>MVAP 24LSP32</b>	32
with lever and cover, high construction				<b>MVAP 24LSP40</b>	40

panel cut-out for bulkhead mounting housings

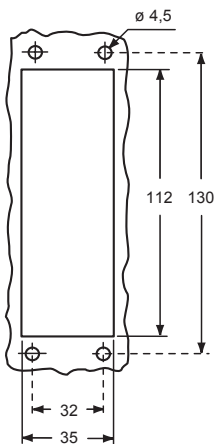

**CVI LSP**

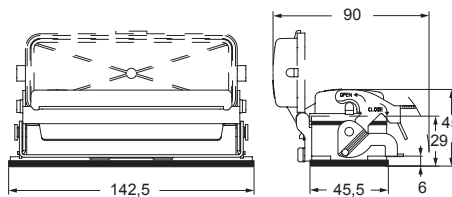

**CVP - CVAP LSP and MVP - MVAP LSP**

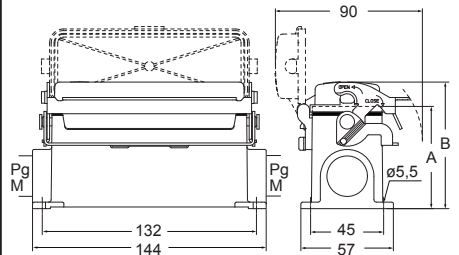

type	A	B
<b>CVP / MVP 24 LSP</b>	63	78
<b>CVAP / MVAP 24 LSP</b>	81	96

☑ The enclosures ensure IP65 degree of protection when mated and locked with the closing lever, or IP44 degree of protection when not mated and locked with lever.

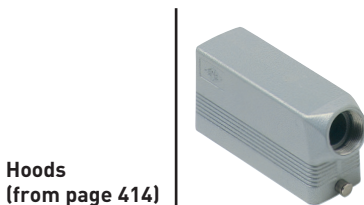

**cURus** Type 4/4X/12

cURus Type 12 / Type 4/4X pending



# CV - CVA and MV - MVA V-TYPE lever version

inserts		page:
CD	64 poles + ⊕	72
CDD	108 poles + ⊕	81
CDS	42 poles + ⊕	-
CDSH	42 poles + ⊕	89
CNE	24 poles + ⊕	113
CSE	24 poles + ⊕	-
CSH	24 poles + ⊕	113
CSH S	24 poles + ⊕	125
CCE	24 poles + ⊕	133
CMSH	10+2 (aux) poles + ⊕	140
CMCE	10+2 (aux) poles + ⊕	141
CSS	24 poles + ⊕	151
CQE	46 poles + ⊕	171
CQEE	64 poles + ⊕	177
CX	4/8 and 6/6 poles + ⊕	204 and 206
MIXO	6 modules	232 - 287

## surface mounting housings with single lever in stainless steel

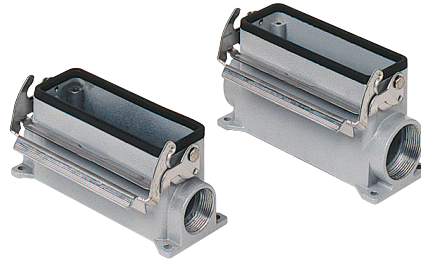

description	part No.	entry Pg	part No	entry M
with lever/s, size "104.27"	<b>CVP 24 L</b>	21	<b>MVP 24 L25</b>	25
with lever/s, size "104.27"	<b>CVP 24 L2</b>	21 x 2	<b>MVP 24 L225</b>	25 x 2
with lever/s, high construction, size "104.27"	<b>CVAP 24 L21</b>	21	<b>MVAP 24 L32</b>	32
with lever/s, high construction, size "104.27"	<b>CVAP 24 L221</b>	21 x 2	<b>MVAP 24 L232</b>	32 x 2
with lever/s, high construction, size "104.27"	<b>CVAP 24 L29</b>	29	<b>MVAP 24 L40</b>	40
with lever/s, high construction, size "104.27"	<b>CVAP 24 L229</b>	29 x 2	<b>MVAP 24 L240</b>	40 x 2

## CVP L - CVAP L and MVP L - MVAP L

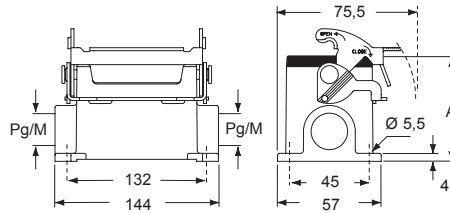

type	A
CVP / MVP 24 L	63
CVAP / MVAP 24 L	81

Hoods  
(from page 414)



**CRUS**® Type 4/4X/12



# CV - CVA and MV - MVA V-TYPE lever version

inserts		page:
CD	64 poles + ⊕	72
CDD	108 poles + ⊕	81
CDS	42 poles + ⊕	-
CDSH	42 poles + ⊕	89
CNE	24 poles + ⊕	113
CSE	24 poles + ⊕	-
CSH	24 poles + ⊕	113
CSH S	24 poles + ⊕	125
CCE	24 poles + ⊕	133
CMSH	10+2 (aux) poles + ⊕	140
CMCE	10+2 (aux) poles + ⊕	141
CSS	24 poles + ⊕	151
CQE	46 poles + ⊕	171
CQEE	64 poles + ⊕	177
CX	4/8 and 6/6 poles + ⊕	204 and 206
MIXO	6 modules	232 - 287

## surface mounting housings with single lever in stainless steel and plastic cover



## surface mounting housings with single lever in stainless steel and aluminium cover



description	part No.		entry Pg		part No.		entry M	
with lever and cover, size "104.27"	<b>CVP 24 LP</b>	21	<b>MVP 24 LP25</b>	25	<b>CVP 24 LS</b>	21	<b>MVP 24 LS25</b>	25
with lever and cover, size "104.27"	<b>CVP 24 LP2</b>	21 x 2	<b>MVP 24 LP225</b>	25 x 2	<b>CVP 24 LS2</b>	21 x 2	<b>MVP 24 LS225</b>	25 x 2
with lever and cover, high construction, size "104.27"	<b>CVAP 24 LP21</b>	21	<b>MVAP 24 LP32</b>	32	<b>CVAP 24 LS</b>	21	<b>MVAP 24 LS32</b>	32
with lever and cover, high construction, size "104.27"	<b>CVAP 24LP221</b>	21 x 2	<b>MVAP 24LP232</b>	32 x 2	<b>CVAP 24 LS2</b>	21 x 2	<b>MVAP 24LS232</b>	32 x 2
with lever and cover, high construction, size "104.27"	<b>CVAP 24 LP29</b>	29	<b>MVAP 24 LP40</b>	40	<b>CVAP 24 LS29</b>	29	<b>MVAP 24 LS40</b>	40
with lever and cover, high construction, size "104.27"	<b>CVAP 24LP229</b>	29 x 2	<b>MVAP 24LP240</b>	40 x 2	<b>CVAP 24LS229</b>	29 x 2	<b>MVAP 24LS240</b>	40 x 2

**N.B.:**  
The enclosures ensure IP66 (or IP65 cover versions) degree of protection when mated and locked with the closing levers.

### CVP LP - CVAP LP and MVP LP - MVAP LP

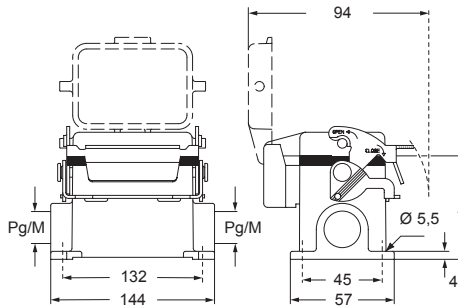

type	A
CVP/MVP 24 LP	63
CVAP/MVAP 24 LP	81

### CVP LS - CVAP LS and MVP LS - MVAP LS

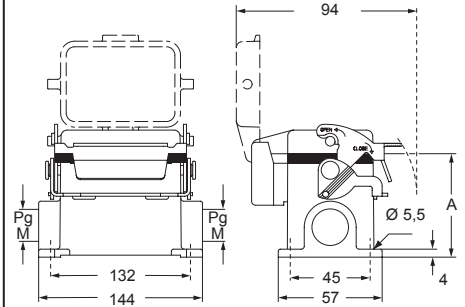

type	A
CVP/MVP 24 LS	63
CVAP/MVAP 24 LS	81

Hoods  
(from page 414)



**CAUS**® Type 4/4X/12  
(except enclosures with plastic cover)



V-TYPE IP65/IP66

**CV - CVA - CVF MV - MVA - MVF V-TYPE lever version**

inserts		page:
CD	64 poles + ⊕	72
CDD	108 poles + ⊕	81
CDS	42 poles + ⊕	-
CDSH	42 poles + ⊕	89
CNE	24 poles + ⊕	113
CSE	24 poles + ⊕	-
CSH	24 poles + ⊕	113
CSH S	24 poles + ⊕	125
CCE	24 poles + ⊕	133
CMSH	10+2 (aux) poles + ⊕	140
CMCE	10+2 (aux) poles + ⊕	141
CSS	24 poles + ⊕	151
CQE	46 poles + ⊕	171
CQEE	64 poles + ⊕	177
CX	4/8 and 6/6 poles + ⊕	204 and 206
MIXO	6 modules	232 - 287

**hoods, top entry,  
with gasket and single lever in stainless steel**



**hoods, top entry,  
with gasket and 2 levers in stainless steel**



description	part No.	entry Pg	part No	entry M	part No.	entry Pg	part No.	entry M
with lever/s, size "104.27"	<b>CVV 24 LG</b>	21	<b>MVV 24 LG32</b>	32	<b>CVV 24 G</b>	21	<b>MVV 24 G32</b>	32
with lever/s, high construction, size "104.27"	<b>CVAV 24 LG21</b>	21	<b>MVAV 24 LG25</b>	25	<b>CVAV 24 G21</b>	21	<b>MVAV 24 G25</b>	25
with lever/s, high construction, size "104.27"	<b>CVAV 24 LG29</b>	29	<b>MVAV 24 LG32</b>	32	<b>CVAV 24 G29</b>	29	<b>MVAV 24 G32</b>	32
with lever, high construction, without adapter, size "104.27"	<b>CVFV 24 LG21</b>	21	<b>MVFV 24 LG25</b>	25	<b>CVFV 24 G21</b>	21	<b>MVFV 24 G25</b>	25
with lever, high construction, without adapter, size "104.27"	<b>CVFV 24 LG29</b>	29	<b>MVFV 24 LG32</b>	32	<b>CVFV 24 G29</b>	29	<b>MVFV 24 G32</b>	32

**N.B.:**  
The enclosures ensure IP66 (or IP65 cover versions) degree of protection when mated and locked with the closing levers.

**CVV LG - CVAV LG - CVFV LG and  
MVV LG - MVAV LG - MVFV LG**

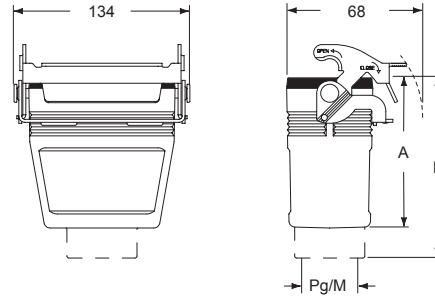

type	A	B
<b>CVV/MVV 24 LG</b>	60,5	73,5
<b>CVAV/MVAV 24 LG</b>	81	97
<b>CVFV/MVFV 24 LG</b>	81	-

**CVV G - CVAV G - CVFV G and  
MVV G - MVAV G - MVFV G**

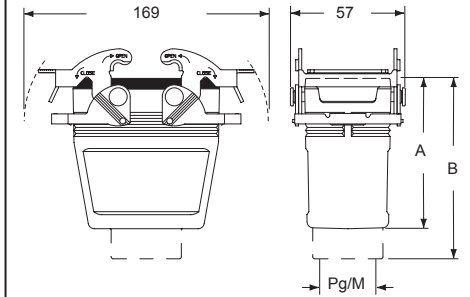

type	A	B
<b>CVV/MVV 24 G</b>	60,5	73,5
<b>CVAV/MVAV 24 G</b>	81	97
<b>CVFV/MVFV 24 G</b>	81	-

**Hoods**  
(from page 414)



**CAUS** Type 4/4X/12



V-TYPE IP65/IP66

## The space you have always needed

**BIG Series**, based on the wide-ranging experience achieved by ILME, introduces a significant **change in the design of hoods and has been specifically designed to meet the new requirements of the wiring market**. The enclosures **integrate the existing range and are ideal for installations with structured and complex wiring**.



### Accurate design

The **large dimensions** of these innovative enclosures have been chosen to offer customers an **adequate space to store conductors**.

The **width** of the new enclosures is **greater than that of previous versions**: 66 mm compared to the 43 mm for standard enclosures. The **height** of BIG enclosures has also been **increased to 100 mm** for sizes "44.27" and "57.27" (standard versions for high models: 70 and 72mm), **and to 110 mm** for sizes "77.27" and "104.27" (standard versions for high models: 76 mm).

**The cable compartment is now fully accessible during assembly** (the connector insert is fully inserted in the lower half of

the enclosure), **offering three times the space compared to standard enclosures**. This means it is possible to bend cables and pipes with greater bending radii.

Due to this important feature, the new BIG enclosures are **particularly suitable for MIXO modular inserts**, being versatile and customizable, for multiple cable entries.

**Each insert**, differentiated according to electric power or signal, pneumatic, optical fiber or Ethernet network current, **may thus have the specific branching. One single large connector can replace what previously required two connectors**.

### Ease of use

The possibility of **splitting the enclosure in two halves simplifies the installation of the insert**. It is also possible to **connect the insert with a cable and later insert it in the lower half of the enclosure** (except for the 6 pole version).

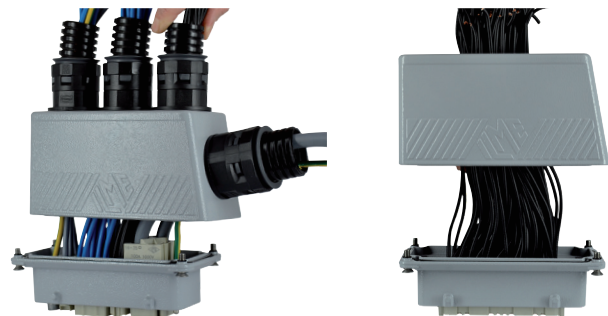

### Options for the connection of control and signalling devices

All the five walls of the upper half of the enclosure have a high thickness to allow them to be drilled and threaded, even with multiple threads.

BIG enclosures enable the connection – of push – buttons, selectors, switches and signalling lamps after the necessary holes have been drilled. It is possible, for example, to enable power supplies or signalling circuits, even after the connector has been coupled.





### Simplified installation

Installation operations for the new hoods are simple and fast. No special accessories, tools or expensive additional operations are required.

**The lower half of the enclosure must be fixed to the upper half by means of the 4 screws supplied.**

It is possible to prevent the fixing screws from coming loose by fitting on each screw the O-ring seal supplied with the enclosures.

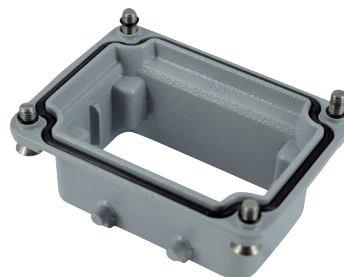

### Compartment for electronic boards

It is possible to install electronic boards in the lower section of enclosures with side entry. In this case, it is however necessary to order CR MBS screws separately to fix the board in place.

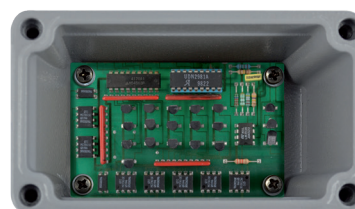

### Greater protection

It is also possible to fix one earthing terminal in the upper half of the enclosure to provide protection against indirect contacts.

In this case, it is however necessary to order separately earthing terminal CR MBT, consisting of a fixing screws and a wire-terminal for 6 mm<sup>2</sup> conductors.



### Range

The items are classified with the following pre-code:

- MBO for enclosures with side entry
- MBV for enclosures with one or more top entries
- MBVO for enclosures with top and side entries
- CBC for closed enclosures that can be drilled

The available versions are:

- for enclosures with size "44.27": **single lever**
- for enclosures with sizes "57.27", "72.27" and "104.27": **two levers**

### SUM-UP

- ☑ **The BIG enclosures are made in die-cast aluminum alloy and are fitted with cast pegs with a reinforced design, painted with epoxy-polyester powder paint. The sealing gasket in anti-aging NBR elastomer, resistant to oils and fuels, is positioned internally to guarantee a greater protection from light and atmospheric agents.**
- ☑ **BIG enclosures guarantee an IP66 protection rating (EN 60529) after the connector has been coupled, and completed with appropriate cable glands; they are manufactured in compliance with standard IEC/EN 61984.**
- ☑ **Ambient temperature range -40°C / +125°C.**
- ☑ **Versions for class W aggressive environments are also available on request.**

### Q WARNING:

Due to the considerable weight of BIG hoods, when fitted with inserts, conductors and cable glands, we recommend to use them in combination with housings fitted with V-TYPE closing levers (C7/M7/CV/MV).

If used in combination with enclosures series CLASS, it is advisable to appropriately anchor the cables in order to prevent their weight from being applied to the closing levers.

# MB wider version BIG

inserts		page:
CDD	24 poles + ⊕	76
CDS	9 poles + ⊕	-
CDSH	9 poles + ⊕	86
CDSH NC	6 poles + ⊕	95
CNE	6 poles + ⊕	110
CSE	6 poles + ⊕	-
CSH	6 poles + ⊕	110
CSH S	6 poles + ⊕	122
CCE	6 poles + ⊕	130
CSS	6 poles + ⊕	148
CT, CTSE (16A)	6 poles + ⊕	160
CQE	10 poles + ⊕	168
MIXO	2 modules	232 - 28

## hoods with 2 pegs



## hoods with 2 pegs



description	part No.	entry	part No.	entry
		M		M
with pegs, side entry	<b>MBO 06 L40</b>	40		
with pegs, side entry	<b>MBO 06 L50</b>	50		
with pegs, top entry	<b>MBV 06 L40</b>	40	<b>MBV 06 L225</b>	25 x 2
with pegs, top entry	<b>MBV 06 L50</b>	50	<b>MBV 06 L320</b>	20 x 3

Housings  
(page 436)



### MBO 06 L

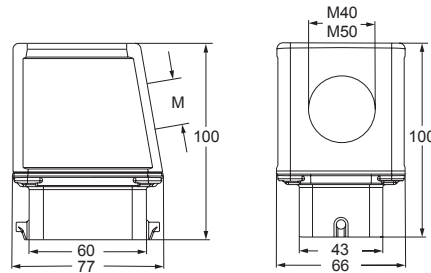

### MBV 06 L225

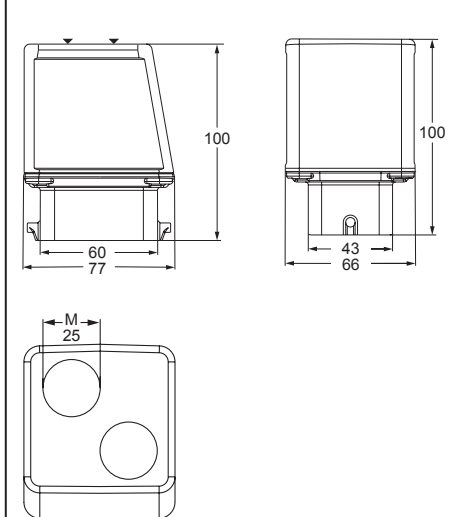

### MBV 06 L

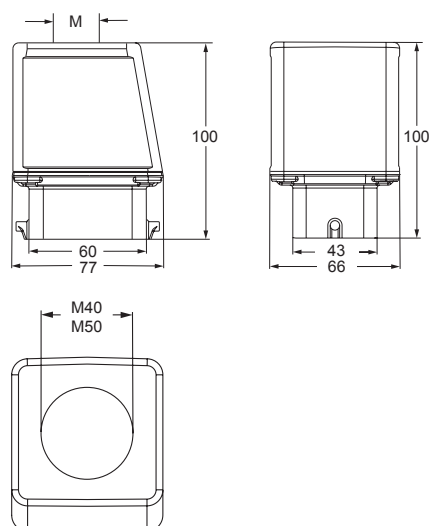

### MBV 06 L320

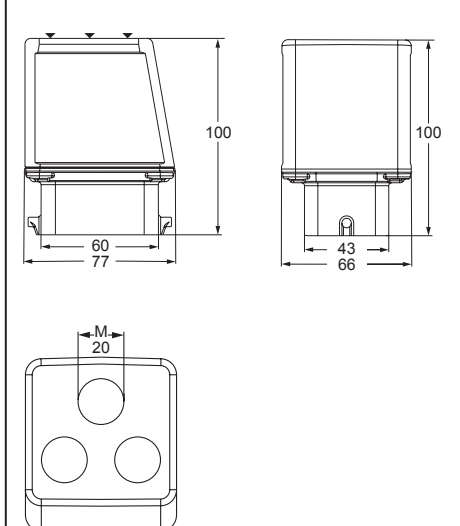

**CAUS**® Type 4/4X/12



IP67 if hoods with fused pegs and without adaptors coupled with IP67 housings)

# CB and MB wider version BIG

inserts		page:
CDD	24 poles + ⊕	76
CDS	9 poles + ⊕	-
CDSH	9 poles + ⊕	86
CDSH NC	6 poles + ⊕	95
CNE	6 poles + ⊕	110
CSE	6 poles + ⊕	-
CSH	6 poles + ⊕	110
CSH S	6 poles + ⊕	122
CCE	6 poles + ⊕	130
CSS	6 poles + ⊕	148
CT, CTSE (16A)	6 poles + ⊕	160
CQE	10 poles + ⊕	168
MIXO	2 modules	232 - 28

## hoods with 2 pegs



## hoods with 2 pegs



description	part No.	entry	part No.
with pegs, side and top entries	<b>MBVO 06 L240</b>	2 x 40	
with pegs, without entries, designed to be drilled			<b>CBC 06 L</b>

Housings  
(page 436)

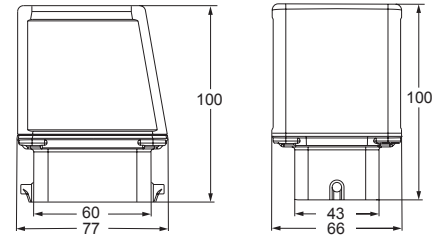
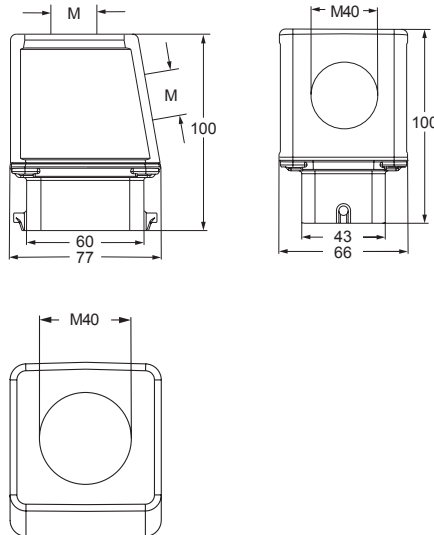

**CAUS**® Type 4/4X/12



IP67 if hoods with fused pegs and without adaptors coupled with IP67 housings)

# MB wider version BIG

inserts		page:
CDD	42 poles + ⊕	78
CDS	18 poles + ⊕	-
CDSH	18 poles + ⊕	87
CNE	10 poles + ⊕	111
CSE	10 poles + ⊕	-
CSH	10 poles + ⊕	111
CSH S	10 poles + ⊕	123
CCE	10 poles + ⊕	131
CMSH	3+2 (aux) poles + ⊕	136
CMCE	3+2 (aux) poles + ⊕	137
CSS	10 poles + ⊕	149
CT, CTSE (16A)	10 poles + ⊕	161
CQE	18 poles + ⊕	169
CX	8/24 poles + ⊕	194
MIXO	3 modules	232 - 287

## hoods with 4 pegs



## hoods with 4 pegs



description	part No.	entry	part No.	entry
		M		M
with pegs, side entry	<b>MBO 10.40</b>	40		
with pegs, side entry	<b>MBO 10.50</b>	50		
with pegs, top entry	<b>MBV 10.40</b>	40	<b>MBV 10.225</b>	25 x 2
with pegs, top entry	<b>MBV 10.50</b>	50	<b>MBV 10.420</b>	20 x 4

dimensions of electronic boards for MBO enclosures side entry

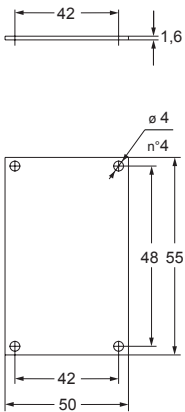

### MBO 10

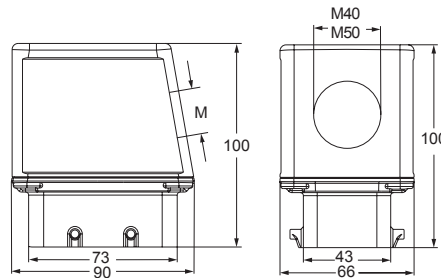

### MBV 10.225

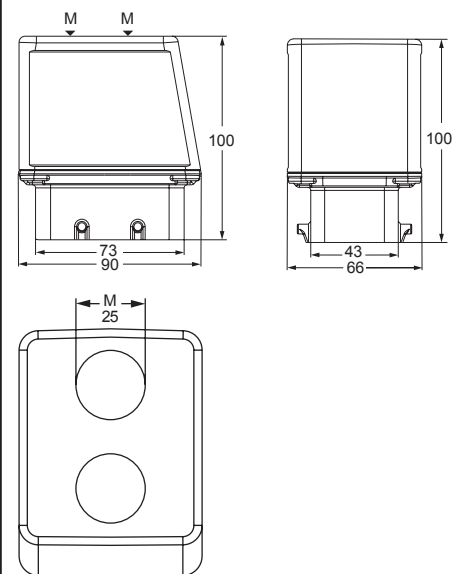

### MBV 10

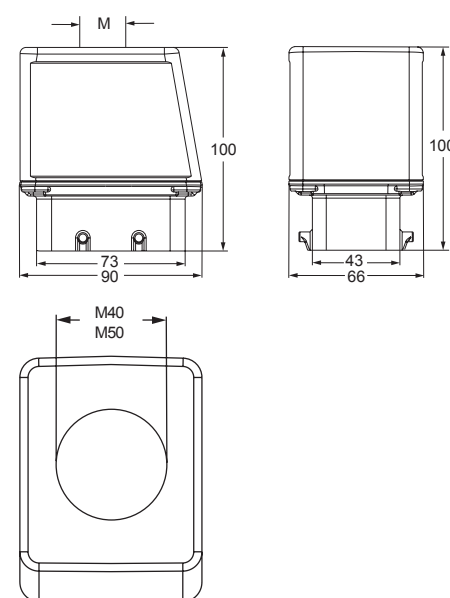

### MBV 10.240

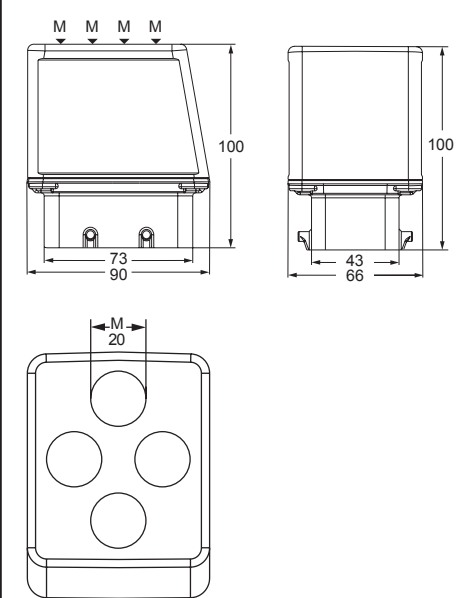

Housings (page 438)



**CAUS**® Type 4/4X/12



IP67 if hoods with fused pegs and without adaptors coupled with IP67 housings)

# CB and MB wider version BIG

inserts		page:
CDD	42 poles + ⊕	78
CDS	18 poles + ⊕	-
CDSH	18 poles + ⊕	87
CNE	10 poles + ⊕	111
CSE	10 poles + ⊕	-
CSH	10 poles + ⊕	111
CSH S	10 poles + ⊕	123
CCE	10 poles + ⊕	131
CMSH	3+2 (aux) poles + ⊕	136
CMCE	3+2 (aux) poles + ⊕	137
CSS	10 poles + ⊕	149
CT, CTSE (16A)	10 poles + ⊕	161
CQE	18 poles + ⊕	169
CX	8/24 poles + ⊕	194
MIXO	3 modules	232 - 287

## hoods with 4 pegs



## hoods with 4 pegs



description	part No.	entry	part No.
with pegs, side and top entries	<b>MBVO 10.240</b>	40 x 2	
with pegs, without entries, designed to be drilled			<b>CBC 10</b>

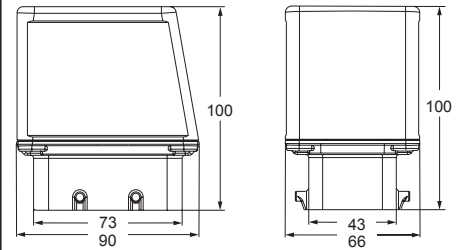
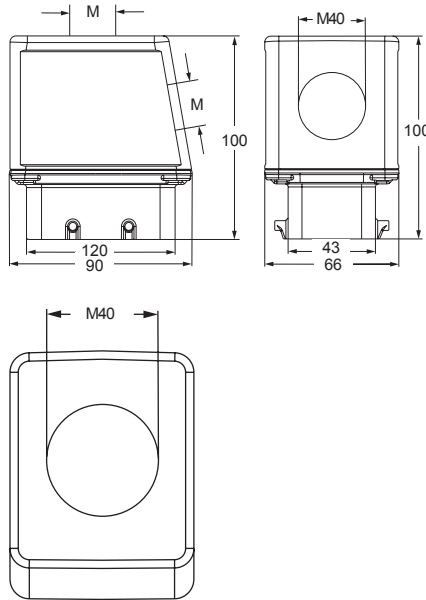

Housings  
(page 438)



**CAUS**® Type  
4/4X/12



IP67 if hoods with fused pegs and without adaptors coupled with IP67 housings)

# MB wider version BIG

inserts		page:
CD	40 poles + ⊕	70
CDD	72 poles + ⊕	79
CDS	27 poles + ⊕	-
CDSH	27 poles + ⊕	88
CNE	16 poles + ⊕	112
CSE	16 poles + ⊕	-
CSH	16 poles + ⊕	112
CSH S	16 poles + ⊕	124
CCE	16 poles + ⊕	132
CMSH, CMCE	6+2 (aux) poles + ⊕	138 - 139
CSS	16 poles + ⊕	150
CT, CTSE (16A)	16 poles + ⊕	162
CQE	32 poles + ⊕	170
CQEE	40 poles + ⊕	176
CP	6 poles + ⊕	178
CX	6/12, 6/36 and 12/2 poles + ⊕	197 - 199
CX	4/0 and 4/2 poles + ⊕	200 - 201
MIXO	4 modules	232 - 287

## hoods with 4 pegs



## hoods with 4 pegs



description	part No.	entry		part No.	entry	
			M			M
with pegs, side entry	<b>MBO 16.40</b>		40			
with pegs, side entry	<b>MBO 16.50</b>		50			
with pegs, top entry	<b>MBV 16.40</b>		40	<b>MBV 16.232</b>		32 x 2
with pegs, top entry	<b>MBV 16.50</b>		50	<b>MBV 16.325</b>		25 x 3

### dimensions of electronic boards for MBO enclosures side entry

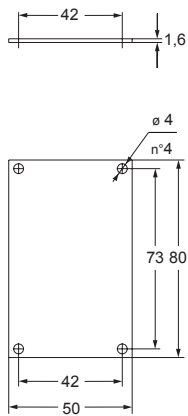

### MBO 16

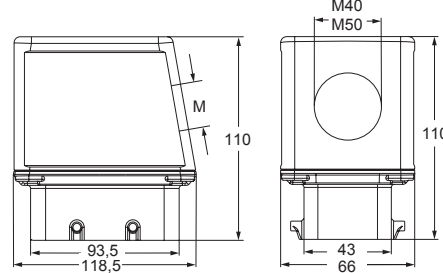

### MBV 16.232

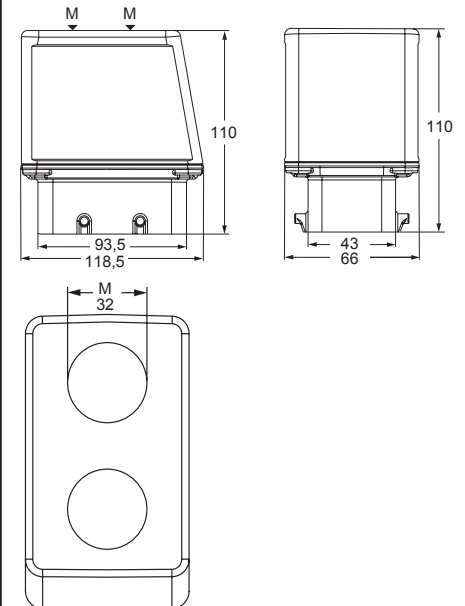

### MBV 16

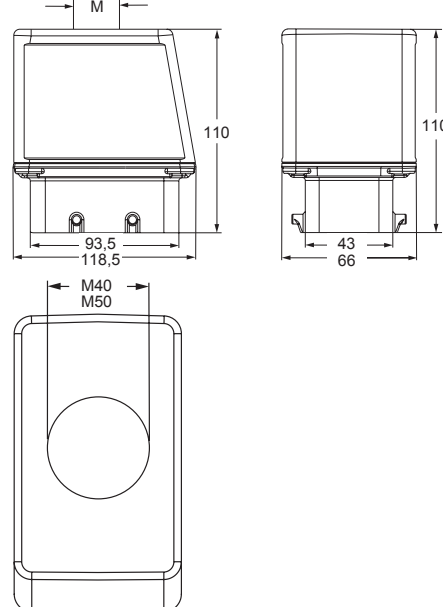

### MBV 16.325

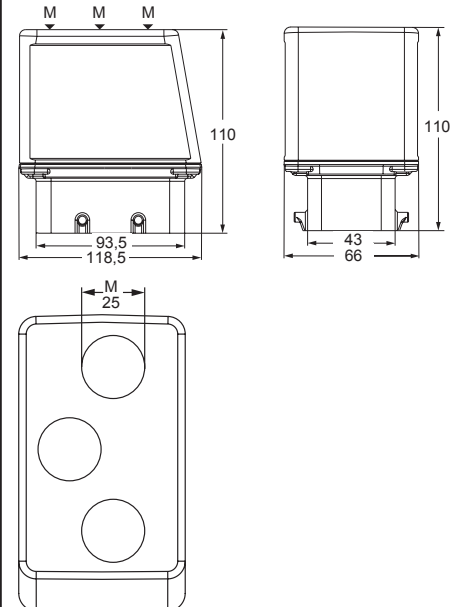

Housings  
(page 439)



**CAUS**® Type 4/4X/12



IP66 if hoods with fused pegs and without adaptors coupled with IP67 housings)



# CB and MB wider version BIG

inserts		page:
CD	40 poles + ⊕	70
CDD	72 poles + ⊕	79
CDS	27 poles + ⊕	-
CDSH	27 poles + ⊕	88
CNE	16 poles + ⊕	112
CSE	16 poles + ⊕	-
CSH	16 poles + ⊕	112
CSH S	16 poles + ⊕	124
CCE	16 poles + ⊕	132
CMSH, CMCE	6+2 (aux) poles + ⊕	138 - 139
CSS	16 poles + ⊕	150
CT, CTSE (16A)	16 poles + ⊕	162
CQE	32 poles + ⊕	170
CQEE	40 poles + ⊕	176
CP	6 poles + ⊕	178
CX	6/12, 6/36 and 12/2 poles + ⊕	197 - 199
CX	4/0 and 4/2 poles + ⊕	200 - 201
MIXO	4 modules	232 - 287

## hoods with 4 pegs



## hoods with 4 pegs



description	part No.	entry		part No.	entry	
			M			M
with pegs, side entry	<b>MBO 16.225</b>		25 x 2			
with pegs, top entry	<b>MBV 16.620</b>		20 x 6			
with pegs, side and top entries				<b>MBVO 16.240</b>		40 x 2
with pegs, without entries, designed to be drilled				<b>CBC 16</b>		--

**MBO 16.225**

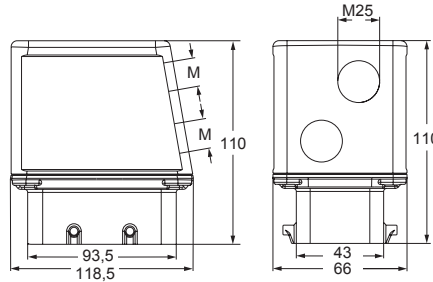

**MBVO 16.240**

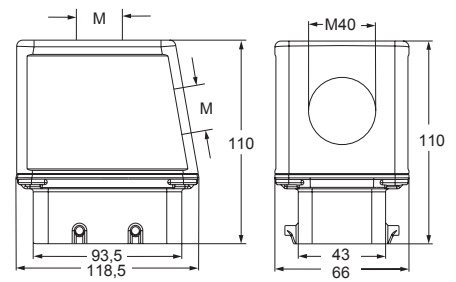

**MBV 16.220**

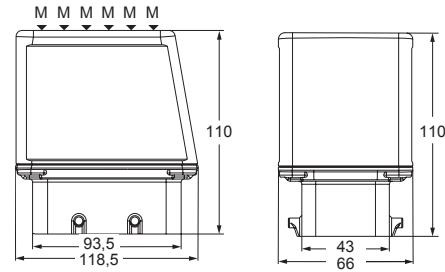

**CBC 16**

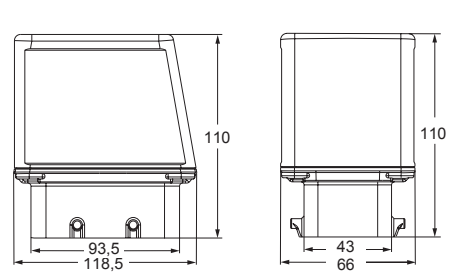

Housings  
(page 439)



**CAUS**® Type  
4/4X/12



IP67 if hoods with fused pegs and without adaptors coupled with IP67 housings)

# MB wider version BIG

inserts		page:
CD	64 poles + ⊕	72
CDD	108 poles + ⊕	81
CDS	42 poles + ⊕	-
CDSH	42 poles + ⊕	89
CNE	24 poles + ⊕	113
CSE	24 poles + ⊕	-
CSH	24 poles + ⊕	113
CSH S	24 poles + ⊕	125
CCE	24 poles + ⊕	133
CMSH	10+2 (aux) poles + ⊕	140
CMCE	10+2 (aux) poles + ⊕	141
CSS	24 poles + ⊕	151
CT, CTSE (16A)	24 poles + ⊕	163
CQE	46 poles + ⊕	171
CQEE	64 poles + ⊕	177
CX	4/8 and 6/6 poles + ⊕	204 and 206
MIXO	6 modules	232 - 287

## hoods with 4 pegs



## hoods with 4 pegs



description	part No.	entry		part No.	entry	
			M			M
with pegs, side entry	<b>MBO 24.40</b>		40			
with pegs, side entry	<b>MBO 24.50</b>		50			
with pegs, top entry	<b>MBV 24.40</b>		40	<b>MBV 24.240</b>		40 x 2
with pegs, top entry	<b>MBV 24.50</b>		50	<b>MBV 24.332</b>		32 x 3

dimensions of electronic boards for MBO enclosures side entry

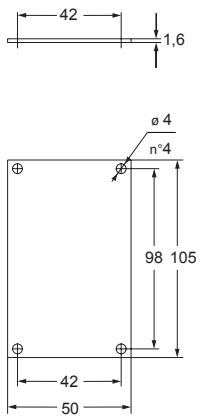

### MBO 24

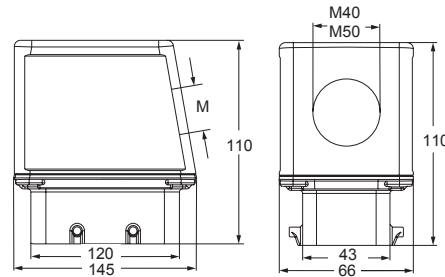

### MBV 24

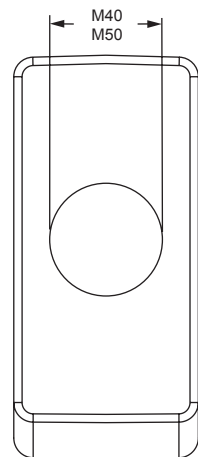
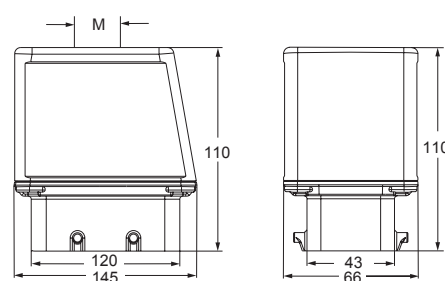

### MBV 24.240 - MBV 24.332

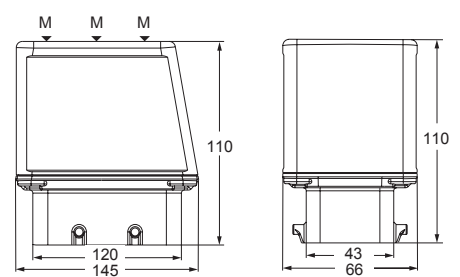

### MBV 24.240

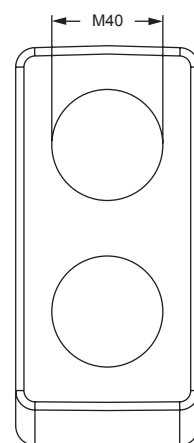

### MBV 24.332

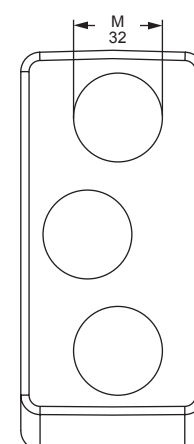

Housings (page 441)



**CAUS** Type 4/4X/12



IP67 if hoods with fused pegs and without adaptors coupled with IP67 housings)

# CB and MB wider version BIG

inserts		page:
CD	64 poles + ⊕	72
CDD	108 poles + ⊕	81
CDS	42 poles + ⊕	-
CDSH	42 poles + ⊕	89
CNE	24 poles + ⊕	113
CSE	24 poles + ⊕	-
CSH	24 poles + ⊕	113
CSH S	24 poles + ⊕	125
CCE	24 poles + ⊕	133
CMSH	10+2 (aux) poles + ⊕	140
CMCE	10+2 (aux) poles + ⊕	141
CSS	24 poles + ⊕	151
CT, CTSE (16A)	24 poles + ⊕	163
CQE	46 poles + ⊕	171
CQEE	64 poles + ⊕	177
CX	4/8 and 6/6 poles + ⊕	204 and 206
MIXO	6 modules	232 - 287

## hoods with 4 pegs



## hoods with 4 pegs



description	part No.	entry M	part No.	entry M
with pegs, side entry	<b>MBO 24.225</b>	25 x 2		
with pegs, top entry	<b>MBV 24.425</b>	25 x 4		
with pegs, top entry	<b>MBV 24.720</b>	20 x 7		
with pegs, side and top entries			<b>MBVO 24.250</b>	50 x 2
with pegs, without entries, designed to be drilled			<b>CBC 24</b>	--

### MBO 24

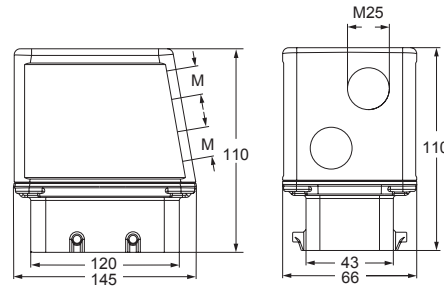

### MBVO 24.250

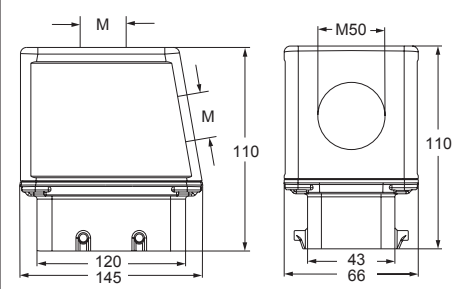

### MBV 24.425 - MBV 24.270

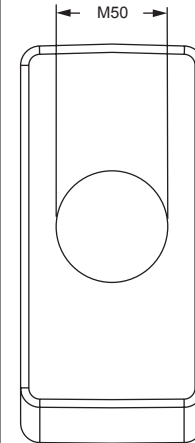
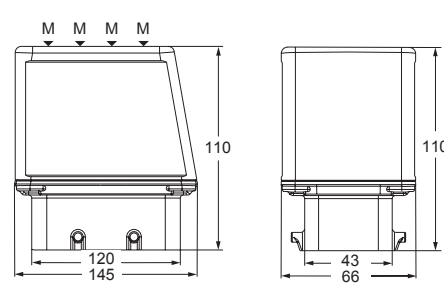

### MBV 24.425

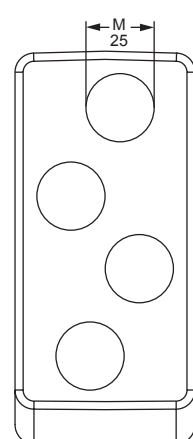

### MBV 24.720

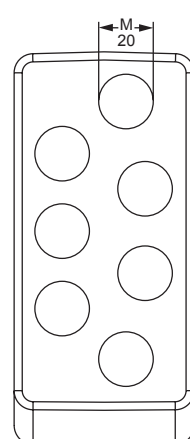

### CBC 24

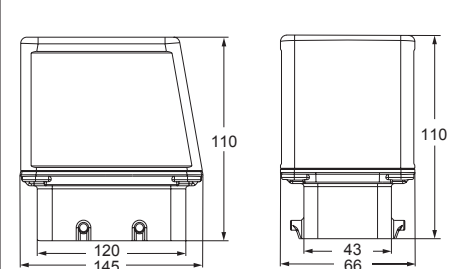

Housings (page 441)

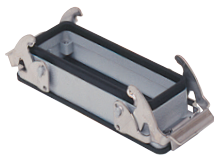

**CAUS**® Type 4/4X/12



IP66 if hoods with fused pegs and without adaptors coupled with IP67 housings)

# T-TYPE enclosures

Standard & Aggressive environments,  
Hygienic applications

**T-TYPE  
STANDARD**  
for standard  
applications



Pages 478-487

**T-TYPE/W**  
for aggressive  
environments



Pages 488-492

**HYGIENIC  
T-TYPE/H**  
for food  
& beverage

**HYGIENIC  
T-TYPE/C**  
for low  
temperatures

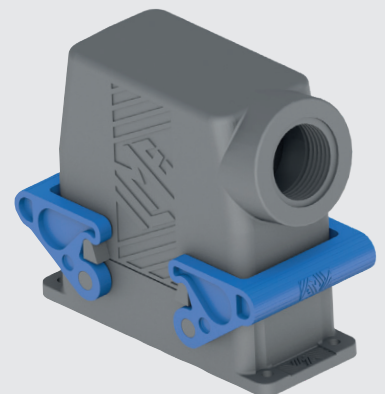

Pages 493-509



**ECOLAB®**

# T-TYPE general information

## International standards

T-TYPE enclosures have been **successfully** tested in accordance with the following international standards, guaranteeing their usage for numerous applications:

**- EN 61984: Connectors - Safety requirements and tests.**

**- ANSI/UL 50 (Enclosures for Electrical Equipment)** equivalent to voluntary North American standard NEMA 250 (NEMA = National Electrical Manufacturers Association) and the corresponding Canadian standard CSA C22.2 No. 94 (Special Purpose Enclosures) for degrees of protection used in North America and required by local installation codes (e.g. NFPA 70 National Electrical Code in the USA, CSA plant standards for Canada). The current type approval was obtained after passing a series of tests carried out in accordance with the standard, in particular: **Type 12 (= NEMA 12)** for internal use, similar to degree of protection IP54 according to IEC/EN 60529. (Only standard T-TYPE enclosures).

**- EN 60529: Degrees of protection provided by enclosures (IP Code)** for ratings IP65, IP66 and IP69 (according to type).

**- EN 62262: Degrees of protection provided by enclosures for electrical equipment against external mechanical impacts (IK Code)** for ratings IK09 (enclosures with levers), IK10 (enclosures without levers).

**- IEC 60068-2-52: Environmental testing - Part 2-52:**

**Salt mist, cyclic:** with 5% solution of sodium chloride (NaCl), solution Ph from 6,5 to 7,2;

**ENVIRONMENTAL CONDITIONS:** salt mist 35 °C for 2 hours; 40 °C for 168 hours with 93% relative humidity;

**NO. OF CYCLES:** 4;

**TEST PASSED:** maintaining the IP degree of protection and with a change of contact resistance  $\leq 50\%$  of the initial value or  $\leq 5 \text{ m}\Omega$ .

**- IEC 60068-2-6: Environmental testing - Part 2-6:**

**Vibration (sinusoidal):** with values 10Hz+500Hz, 0,35 mm amplitude of displacement,  $50 \text{ m/s}^2$  ( $5g_n$ ), crossover point 60,1 Hz;

**NO. OF CYCLES:** 10;

**TEST PASSED:** scanning 3 axes for 2 hours, with a change of contact resistance value  $\leq 50\%$  of the initial value or  $\leq 5 \text{ m}\Omega$  and no micro-interruption ( $\geq 1 \mu\text{s}$ ).

**- IEC 60068-2-3: Environmental testing - Part 2-3:**

**Damp heat, steady state:** at 40 °C, 93% relative humidity, 504 hours;

**TEST PASSED:** with a change of contact resistance value  $\leq 50\%$  of the initial value or  $\leq 5 \text{ m}\Omega$  and no disruptive discharge (insulation resistance  $> 100 \text{ G}\Omega$ ).

**- IEC 60068-2-30: Environmental testing - Part 2-30:**

**Damp heat, cyclic:** 40 °C, 95% relative humidity, 12 hours at ambient temperature;

**NO. OF CYCLES:** 21;

**TEST PASSED:** with a change of contact resistance value  $\leq 50\%$  of the initial value or  $\leq 5 \text{ m}\Omega$  and no disruptive discharge (insulation resistance  $> 100 \text{ G}\Omega$ ).

## T-TYPE general information

## Resistance to chemicals comparison table

	T-TYPE	T-TYPE / W	T-TYPE / H	T-TYPE / C
<b>A</b>				
Acetone (propanone)	x	x	x	x
Active chlorine	x	x	x	x
Alum	●	●	●	●
Ammonia, 10% aqueous solution	●	x	●	●
Ammonia, liquid	x	x	●	●
Ammonium acetate	●	x	●	●
Ammonium carbonate	●	●	●	x
Ammonium chloride	●	●	●	x
Ammonium nitrate	●	●	●	●
Ammonium phosphate	●	●	●	●
Ammonium sulphate	●	●	●	●
Amyl alcohol	□	□	□	x
Aniline	□	□	x	x
Aqua regia (1:3 nitric acid : hydrochloric acid)	x	x	x	x
Asphalt	□	□	□	x

	T-TYPE	T-TYPE / W	T-TYPE / H	T-TYPE / C
<b>B</b>				
Beer	●	●	●	●
Benzene	x	□	x	x
Borax	□	□	□	□
Boric acid	●	●	●	●
Boric acid, 10% aqueous solution	●	●	●	●
Boric water (boric acid 3%)	●	●	●	●
Butane, gas	□	□	□	x
Butane, liquid	□	□	□	x

	T-TYPE	T-TYPE / W	T-TYPE / H	T-TYPE / C
<b>C</b>				
Calcium chloride	●	●	●	●
Calcium chloride, 10% aqueous solution	●	●	●	●
Calcium chloride, diluted suspension	●	●	●	●
Calcium nitrate	●	●	●	●
Calcium sulphate	●	●	x	●
Caustic potash (potassium hydroxide) 10%	x	●	●	x
Citric acid 50% aqueous solution	x	x	●	●
Copper sulphate 10% aqueous solution	●	●	●	●
Cresol	□	□	x	x
Cresolic solution	□	□	x	x
Cutting oil	□	□	□	x
Cyclo-hexane	□	□	□	x

	T-TYPE	T-TYPE / W	T-TYPE / H	T-TYPE / C
<b>D</b>				
Deca-hydro-naphtalene	x	x	x	x
Di-exyl Phtalate	●	x	x	x
Di-isononyl Phtalate	●	x	x	x
Di-optyl Phtalate	●	●	x	x
Diesel Oil	□	□	□	□
Diluted Glucose	●	●	●	●

	T-TYPE	T-TYPE / W	T-TYPE / H	T-TYPE / C
<b>D</b>				
Diluted Glycerine	●	●	●	●
Diluted Glycol	●	●	●	●
Diluted Phenol	□	□	x	x
Diluted urea	●	●	●	●

	T-TYPE	T-TYPE / W	T-TYPE / H	T-TYPE / C
<b>E</b>				
Ethanol (ethyl alcohol)	x	x	x	●
Ethyl alcohol	●	●	□	●
Ethylene-glycol or propylene-glycol	●	●	●	●

	T-TYPE	T-TYPE / W	T-TYPE / H	T-TYPE / C
<b>F</b>				
Fatty acids	●	●	●	□
Ferric chloride, 10% aqueous solution	x	x	x	x
Formalin (formaldehyde 40% aqueous solution)	x	x	●	●
Fruit juices	●	●	●	●
Fuel oils	□	□	□	x

	T-TYPE	T-TYPE / W	T-TYPE / H	T-TYPE / C
<b>G</b>				
Gaseous ammonia	□	x	●	●
Gaseous propane	x	●	●	x
Glycerine	●	●	●	●
Grinding oil	□	□	□	x
Gypsum (see calcium sulphate)	●	●	x	●

	T-TYPE	T-TYPE / W	T-TYPE / H	T-TYPE / C
<b>H</b>				
Heptane	□	□	□	x
Hexane	□	□	□	x
Hydrochloric acid, <2% aqueous solution	x	x	●	□
Hydrogen sulphide	□	x	●	x

	T-TYPE	T-TYPE / W	T-TYPE / H	T-TYPE / C
<b>I</b>				
Ink	●	●	●	●
IRM oil 901	●	●	●	●
IRM oil 902	□	●	●	x
IRM oil 903	x	□	□	□
Isopropyl alcohol	□	●	●	●

	T-TYPE	T-TYPE / W	T-TYPE / H	T-TYPE / C
<b>K</b>				
Kitchen salt, aqueous solution	●	●	●	●

	T-TYPE	T-TYPE / W	T-TYPE / H	T-TYPE / C
<b>L</b>				
Lactic acid	●	●	●	●
Linseed oil	●	●	●	●
Liquid soap	x	●	●	●
Lubricating engine oil	□	□	□	x
Lubricating oil	●	●	●	x



The classification herewith provided is only a generic reference guide in order to enable a first selection. It is based on literature data provided by the suppliers of the raw materials used, which are related to tests carried out on specimens under test conditions which are not always homogeneous and involving accelerating techniques, therefore not necessarily describing real operational conditions. The actual behaviour of products in the field may therefore be positively or negatively influenced by

several variable environmental parameters such as temperature, relative humidity, simultaneous presence of a plurality of substances and their concentration, exposure time, dynamic or static application condition, and so on. The accuracy of transferring the indications given herein to the actual conditions of use is therefore merely indicative and does not imply any guarantee or responsibility by ILME.

	T-TYPE	T-TYPE / W	T-TYPE / H	T-TYPE / C
<b>M</b>				
Mercury	●	●	●	●
Methanol (methyl alcohol)	x	x	●	●
Methyl alcohol, diluted 50%	□	□	●	●
Mineral based oil	●	●	●	●
Mineral oils (un-tasteful)	●	●	●	●
Mothballs (naphthalene, paradichlorobenzene)	□	□	x	x
Muriatic acid, concentrated	x	x	x	x

<b>N</b>				
n-Butanol (butyl alcohol)	●	●	●	●
Naphthalene	□	●	x	x
Normal (low octane) gasoline (petrol)	□	□	□	x

<b>O</b>				
Octane	□	□	□	x
Oleic acid	●	●	●	x
Oxalic acid	●	●	●	●
Ozone	x	x	x	□

<b>P</b>				
Paraffin oil	●	●	●	●
Petrol ether	□	□	□	□
Petroleum	●	●	●	●
Petroleum spirit (dry cleaning)	□	□	x	x
Potassium carbonate	●	●	●	●
Potassium chlorate	●	●	x	●
Potassium chloride	●	●	●	●
Potassium cyanide, aqueous solution	●	●	●	●
Potassium di-chromate	□	□	●	●
Potassium iodide	□	□	●	●
Potassium nitrate	□	x	x	●
Potassium persulphate	□	□	x	●
Potassium sulphate	□	□	●	●

<b>S</b>				
Sea water	●	●	●	●
Silicon oil	●	●	●	x
Soap solution	□	●	●	●
Sodium bicarbonate (oxide)	●	●	●	●
Sodium carbonate (washing soda)	●	●	●	●
Sodium chlorate	●	●	x	●
Sodium chloride (kitchen salt)	●	●	●	●
Sodium disulphate, aqueous solution	●	●	●	●
Sodium hydroxide (caustic soda)	x	x	●	●
Sodium hydroxide 12,5% (liscivia)	□	x	●	●
Sodium Hypochlorite	x	x	●	●

	T-TYPE	T-TYPE / W	T-TYPE / H	T-TYPE / C
<b>S</b>				
Sodium nitrate	●	●	●	x
Sodium nitrite	□	□	●	x
Sodium perborate	●	●	●	●
Sodium phosphate	●	●	●	x
Sodium silicate	●	x	x	●
Sodium sulphate	●	●	●	●
Sodium sulphide	●	●	●	●
Sodium Thiosulphate (photographic fixer)	●	●	●	●
Solution for photographic processing	●	●	●	●
Starch, aqueous (amylum)	●	●	●	●
Stearic acid	●	●	●	●
Succinic acid (butanedioic acid)	●	●	●	●
Sulphur	●	●	x	x
Sulphur dioxide (sulphurous anhydride)	□	x	x	□
Sulphuric acid, 2% aqueous solution	x	x	□	□

<b>T</b>				
Tallow	●	●	●	●
Tar	□	□	x	□
Tartaric acid	●	●	●	●
Toluene	x	x	x	x
Transformer oil (dielectric)	●	●	●	●
Trichloroethylene	x	x	x	x
Trichresyl phosphate	●	●	x	x
Turpentine essence	x	□	□	x

<b>U</b>				
Urine	●	●	●	●

<b>V</b>				
Vegetable oil	●	●	●	●
Vinegar	x	□	●	□

<b>W</b>				
Water	●	●	●	●
White alcohol (isopropanol + ethanol)	□	●	●	●

<b>X</b>				
Xylene	x	x	x	x

#### Legend

● : Resistant   □ : Limited resistance   x : Not resistant

## T-TYPE standard

### For modular and standard inserts

Alongside the wide range of traditional metallic enclosures for multipole connectors, ILME first "pioneered" a **series of enclosures in self-extinguishing thermoplastic material** in the most common sizes "44.27", "57.27", "77.27" and "104.27".

**Quality and money saving** are the main features of these enclosures, as an outcome of careful product studies.

**Valuable characteristics** of these new versions of enclosures:

- **significant structural solidity** and mechanical robustness by virtue of **substantial thickness**;
- **external dimensions** of the bulkhead mounting housings are **similar to those of the corresponding metallic enclosures**; **hole fixing centres are unchanged**;
- **pre-fastened gaskets** for easier installation;
- **wide space inside the enclosures** for cables, with mounted connector inserts, similar to the corresponding "high construction" versions;
- possibility of making **total insulation** constructions (equivalent to Class II) ☐ ;
- **absence of powder paint** for environments in which these are not recommended (e.g. to avoid food contamination).

#### STANDARD APPLICATIONS

##### SUM-UP

- ☑ Enclosures in thermoplastic material, dark grey RAL 7012 colour, with high thicknesses providing structural solidity and durability.
- ☑ Built-in polyurethane gaskets.
- ☑ Locking levers in thermoplastic material colour grey RAL 7001.
- ☑ M25, M32 and M40 threaded cable entries.
- ☑ IP65/IP69 degree of protection according to EN 60529;
- ☑ UL TYPE 12 degree of protection according to ANSI/UL50.
- ☑ Each enclosure carries its own part number, thread/size, conformity markings and UL type rating.
- ☑ Ambient temperature range: -40 °C / +90 °C.



#### Interchangeability with other ILME series

T-TYPE series housings can be coupled with metal hoods. Insulating hoods can be coupled with "V-TYPE" metal housings.

Hoods "57.27", "77.27" and "104.07" can be mounted on COB TCQ and COB BC frames simply by replacing the supplied levers with COB L levers (to be purchased separately).

Insulating enclosures are ideal for mounting of all ILME inserts with the exception of series models CT 40/ 64 and CTS 40/ 64 connector.

Inserts with 45° terminals of the CT series (screw-type terminals) and CTSE (spring terminals) are only insertable from the front (therefore not from the back) of the bulkhead mounting housings.

Being made by insulating material, they do not require a special reinforced insulation as metal ones do, for use with series CME higher voltage connector inserts (screw-type terminals).

With the exception of the limitations described below, it is generally possible to mount the MIXO series modular connectors and frames with the ground and screen anchors dedicated to this series.

#### Limitations

With respect to enclosures in metal alloy, ILME insulating enclosures have some limitations of use in combination with particular accessories:

- CRZ 06/ 10/ 16/ 24 reduction plates cannot be mounted with bulkhead mounting housings due to increased dimensions of the fastening flange of these insulating enclosures.
- The CYG 16 in-line joint cannot be mounted on the bulkhead mounting housings T-TYPE series because the gaskets of the latter do not fit together with the joint profile.
- The CYR 16.3 and CYR 24.4 round cable feed-throughs are difficult to position on their respective bulkhead mounting housings T-TYPE series.
- CPT 24 disposable protection cover cannot be mounted on insulating enclosures due to increased outer dimensions of these enclosures.
- MIXO series insert anchors cannot be mounted on TMAO 06/10 enclosures.
- CN insert anchors cannot be mounted on TMAO 06/10 enclosures.
- When using both cable entries of surface mounting housings, the conduit shall be of insulating type.

## FOCUS ON:

### 1 Construction

By using the BC-MUL® moulding technique and use of MIL.BOX® material, **these enclosures are structurally solid and mechanically robust**, due to their increased thickness. They are particularly resistant to the main pollutants present in industrial environments. The lever enclosure pegs are built into the enclosures. The methods for fastening the connector inserts to the enclosures are made of M3 threaded metal inserts.

With reference to metal construction enclosures, which to comply with the electrical installation safety norms, must be earthed via a metal connection to the grounding terminal of the inserts mounted inside the enclosures, the new series of enclosures offers a solution for **total insulation** constructions (equivalent to class II) where necessary. The thermoplastic material used is RAL 7012 dark grey colour and UL 94V-2 grade self-extinguishing and has passed glow wire testing in accordance with the IEC (EN) 60695-2-11 at 650 °C in compliance with intended uses.

The **surface mounting** high construction housings are supplied **with an open threaded entry** and diametrically opposite a closed threaded entry, which can be **opened** by the user, if required (with suitable tool).

Manufactured from insulating material, they do not require **special reinforced insulation** as the metal versions do, for use with series **CME higher voltage** connector inserts (screw-type terminals).

### 2 Gaskets

T-TYPE standard sealing gaskets have been produced by means of the FIPFG technology (Formed-In-Place-Foam-Gasket). They have therefore been incorporated in the base flange on bulkhead mounting housings for easier installation.

**T-TYPE standard: Built-in polyurethane gaskets**

### 3 Levers

The locking levers have been produced in self-extinguishing thermoplastic material, grey RAL 7001 colour.

### 4 Dimensions

The internal dimensions allow mounting of all connector inserts in their relevant sizes. The external dimensions of the bulkhead mounting housings are similar to those of the corresponding metallic enclosures; hole fixing centres are unchanged.

Hoods offer an inner cabling space similar to that of the “high” construction models of the corresponding metal enclosures. Other characteristics are in compliance with the applicable safety standard for electrical connectors, IEC/EN 61984.

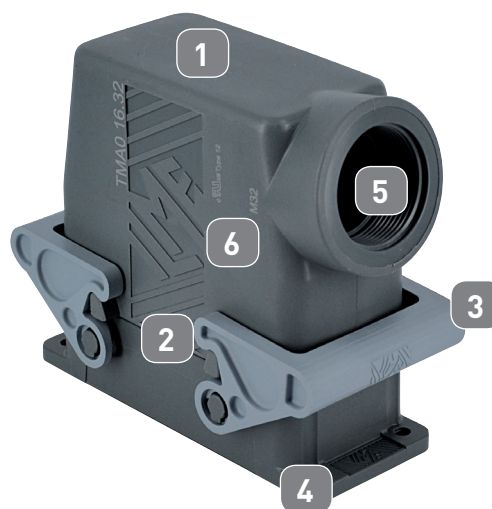

### 5 Cable entries

The housing and hood cable entries are available with metric thread, respectively:

- Q **M25 or M32** for smaller sizes “44.27” and “57.27”.
- Q **M32 or M40** for larger sizes “77.27” and “104.27”.

The recent standard IEC/EN 61076-7-100 regarding metric cable entries for multipole electrical connectors for heavy duty uses, which standardises some main dimensions for entries and their related accessories (gaskets, pressure nuts), have been carefully considered in the product design.

### 6 Markings

Each enclosure carries its own part number and conformity markings.

# T-TYPE insulating STANDARD APPLICATIONS

inserts		page:
CDD	24 poles + ⊕	76
CDS	9 poles + ⊕	-
CDSH	9 poles + ⊕	86
CDSH NC	6 poles + ⊕	95
CNE	6 poles + ⊕	110
CSE	6 poles + ⊕	-
CSH	6 poles + ⊕	110
CSH S	6 poles + ⊕	122
CCE	6 poles + ⊕	130
CSS	6 poles + ⊕	148
CT, CTSE (16A) *)	6 poles + ⊕	160
CQE	10 poles + ⊕	168
MIXO	2 modules	232 - 28

\*) only for standard insulating version TCHI

## housings with single lever

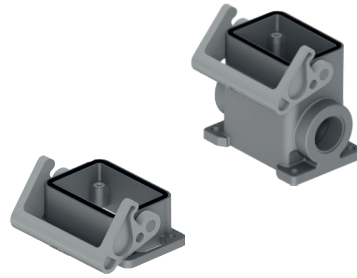

## hoods with 2 pegs



description	part No.	entry M	part No.	entry M
bulkhead mounting housing with thermoplastic lever	<b>TCHI 06 L</b>			
surface mounting housing with thermoplastic lever, high construction	<b>TMAP 06 L25</b>	25		
surface mounting housing with thermoplastic lever, high construction	<b>TMAP 06 L32</b>	32		
with pegs, side entry, high construction			<b>TMAO 06 L25</b>	25
with pegs, side entry, high construction			<b>TMAO 06 L32</b>	32
with pegs, top entry, high construction			<b>TMAV 06 L25</b>	25
with pegs, top entry, high construction			<b>TMAV 06 L32</b>	32

## panel cut-out for bulkhead mounting housings

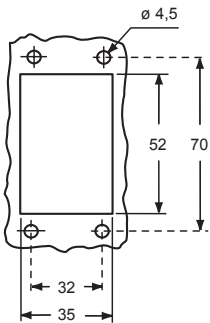

## TCHI L

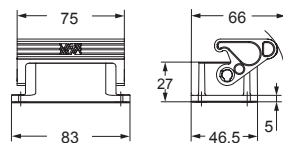

## TMAP L

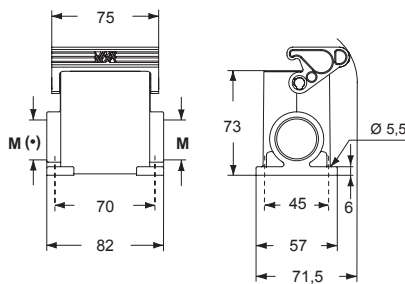

(\*) The surface mounting, high construction housings are supplied with an open threaded entry (\*) and diametrically opposite a closed threaded entry which can be opened by the user if required (with suitable tool).

## TMAO L

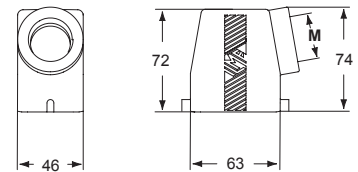

## TMAV L

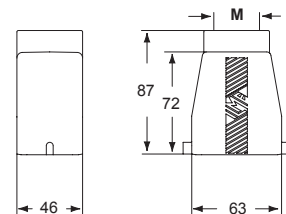

**CAIUS**® Type 12



ambient temperature limits -40 °C / +90 °C

T-TYPE STANDARD

# T-TYPE insulating STANDARD APPLICATIONS

inserts		page:
CDD	24 poles + ⊕	76
CDS	9 poles + ⊕	-
CDSH	9 poles + ⊕	86
CDSH NC	6 poles + ⊕	95
CNE	6 poles + ⊕	110
CSE	6 poles + ⊕	-
CSH	6 poles + ⊕	110
CSH S	6 poles + ⊕	122
CCE	6 poles + ⊕	130
CSS	6 poles + ⊕	148
CT, CTSE (16A) *)	6 poles + ⊕	160
CQE	10 poles + ⊕	168
MIXO	2 modules	232 - 28

\*) only for standard insulating version TCHI

## hoods with single lever top entry



## covers



description	part No.	entry M	part No. (with eyelet)	part No. (with loop)
with thermoplastic lever and gasket, high construction	<b>TMAV 06 LG25</b>	25		
with thermoplastic lever and gasket, high construction	<b>TMAV 06 LG32</b>	32		
with pegs			<b>TCHC 06 L</b>	<b>TCHC 06 SL</b>
with thermoplastic lever and gasket				<b>TCHC 06 LG</b>

### TMAV LG

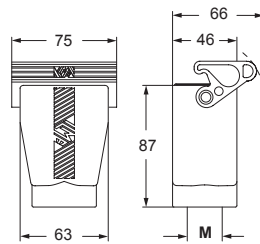

### TCHC L (SL)

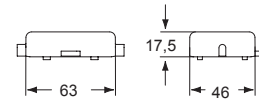

### TCHC LG

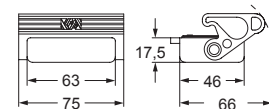

For fixing on housings

eyelet

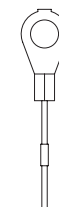

For fixing on hoods

loop

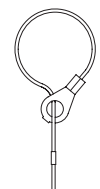

**CAVUS**® Type 12



ambient temperature limits -40 °C / +90 °C

# T-TYPE insulating STANDARD APPLICATIONS

inserts		page:
CDD	42 poles + ⊕	78
CDS	18 poles + ⊕	-
CDSH	18 poles + ⊕	87
CNE	10 poles + ⊕	111
CSE	10 poles + ⊕	-
CSH	10 poles + ⊕	111
CSH S	10 poles + ⊕	123
CCE	10 poles + ⊕	131
CMSH	3+2 (aux) poles + ⊕	136
CMCE	3+2 (aux) poles + ⊕	137
CSS	10 poles + ⊕	149
CT, CTSE (16A) *)	10 poles + ⊕	161
CQE	18 poles + ⊕	169
CX	8/24 poles + ⊕	194
MIXO	3 modules	232 - 287

\*) only for standard insulating version TCHI

## housings with double lever

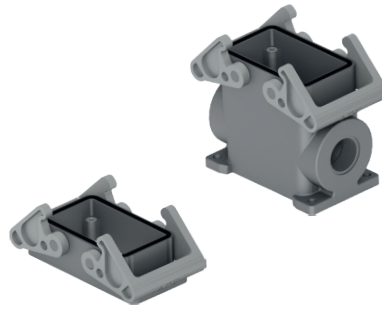

## hoods with 4 pegs

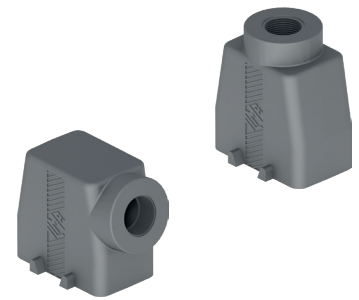

description	part No.	entry M	part No.	entry M
bulkhead mounting housing with thermoplastic levers	<b>TCHI 10</b>			
surface mounting housing, thermoplastic levers, high construction	<b>TMAP 10.25</b>	25		
surface mounting housing, thermoplastic levers, high construction	<b>TMAP 10.32</b>	32		
with pegs, side entry, high construction			<b>TMAO 10.25</b>	25
with pegs, side entry, high construction			<b>TMAO 10.32</b>	32
with pegs, top entry, high construction			<b>TMAV 10.25</b>	25
with pegs, top entry, high construction			<b>TMAV 10.32</b>	32

### panel cut-out for bulkhead mounting housings

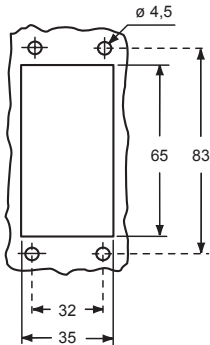

### TCHI

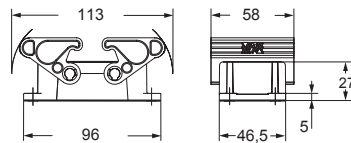

### TMAP

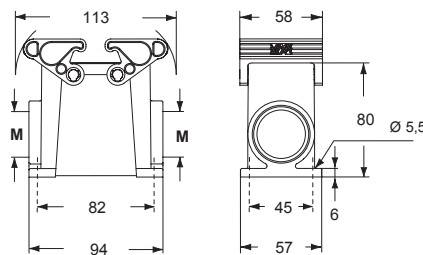

The surface mounting, high construction housings are supplied with an open threaded entry and diametrically opposite a closed threaded entry which can be opened by the user if required (with suitable tool).

### TMAO

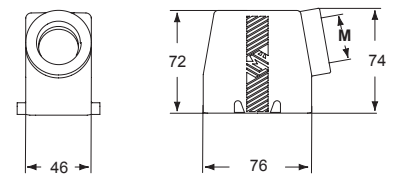

### TMAV

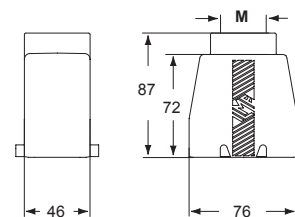

**CAIUS** Type 12



ambient temperature limits -40 °C / +90 °C

T-TYPE STANDARD



# T-TYPE insulating STANDARD APPLICATIONS

inserts		page:
CDD	42 poles + ⊕	78
CDS	18 poles + ⊕	-
CDSH	18 poles + ⊕	87
CNE	10 poles + ⊕	111
CSE	10 poles + ⊕	-
CSH	10 poles + ⊕	111
CSH S	10 poles + ⊕	123
CCE	10 poles + ⊕	131
CMSH	3+2 (aux) poles + ⊕	136
CMCE	3+2 (aux) poles + ⊕	137
CSS	10 poles + ⊕	149
CT, CTSE (16A) *)	10 poles + ⊕	161
CQE	18 poles + ⊕	169
CX	8/24 poles + ⊕	194
MIXO	3 modules	232 - 287

\*) only for standard insulating version TCHI

## hoods with double lever top entry



## covers

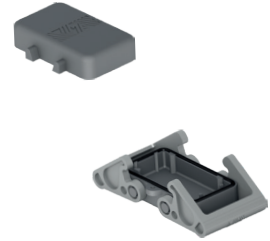

description	part No.	entry M	part No. (with eyelet)	part No. (with loop)
with thermoplastic levers and gasket, high construction	<b>TMAV 10 G25</b>	25		
with thermoplastic levers and gasket, high construction	<b>TMAV 10 G32</b>	32		
with 4 pegs			<b>TCHC 10</b>	<b>TCHC 10 S</b>
with 2 thermoplastic levers and gasket				<b>TCHC 10 G</b>

### TMAV G

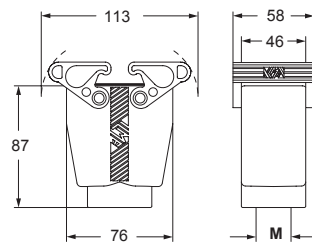

### TCHC (S)

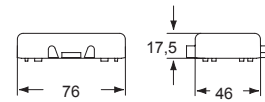

### TCHC G

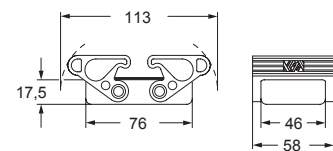

For fixing on housings

eyelet

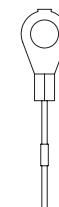

For fixing on hoods

loop

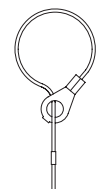

**CAVUS** Type 12



ambient temperature limits -40 °C / +90 °C

# T-TYPE insulating STANDARD APPLICATIONS

inserts		page:
CD	40 poles + ⊕	70
CDD	72 poles + ⊕	79
CDS	27 poles + ⊕	-
CDSH	27 poles + ⊕	88
CNE	16 poles + ⊕	112
CSE	16 poles + ⊕	-
CSH	16 poles + ⊕	112
CSH S	16 poles + ⊕	124
CCE	16 poles + ⊕	132
CMSH, CMCE	6+2 (aux) poles + ⊕	138 - 139
CSS	16 poles + ⊕	150
CT, CTSE (16A) *)	16 poles + ⊕	162
CQE	32 poles + ⊕	170
CQEE	40 poles + ⊕	176
CP	6 poles + ⊕	178
CX	6/12, 6/36 and 12/2 poles + ⊕	197 - 199
CX	4/0 and 4/2 poles + ⊕	200 - 201
MIXO	4 modules	232 - 287

\*) only for standard insulating version TCHI

## housings with double lever

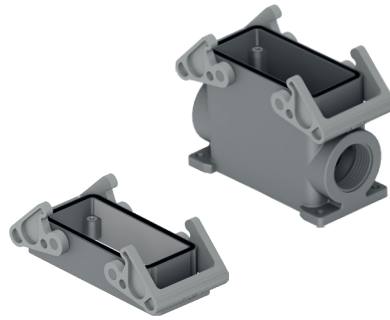

## hoods with 4 pegs



description	part No.	entry M	part No.	entry M
bulkhead mounting housing with thermoplastic levers	<b>TCHI 16</b>			
surface mounting housing, thermoplastic levers, high construction	<b>TMAP 16.32</b>	32		
surface mounting housing, thermoplastic levers, high construction	<b>TMAP 16.40</b>	40		
with pegs, side entry, high construction			<b>TMAO 16.32</b>	32
with pegs, side entry, high construction			<b>TMAO 16.40</b>	40
with pegs, top entry, high construction			<b>TMAV 16.32</b>	32
with pegs, top entry, high construction			<b>TMAV 16.40</b>	40

## panel cut-out for bulkhead mounting housings

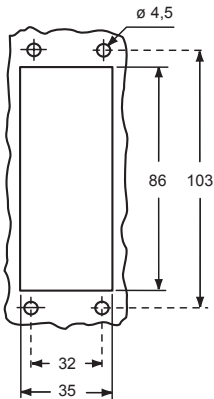

## TCHI

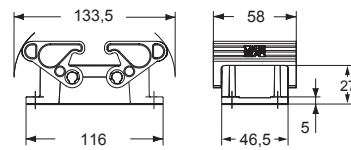

## TMAP

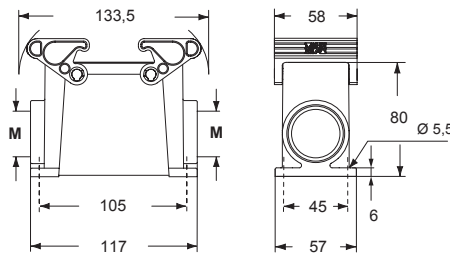

## TMAO

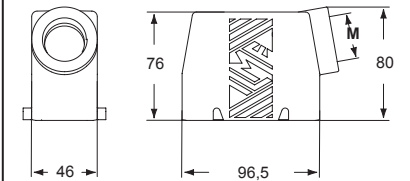

## TMAV

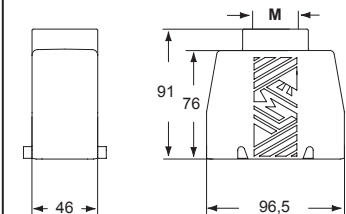

The surface mounting, high construction housings are supplied with an open threaded entry and diametrically opposite a closed threaded entry which can be opened by the user if required (with suitable tool).

**CAUS**® Type 12



ambient temperature limits -40 °C / +90 °C

T-TYPE STANDARD

# T-TYPE insulating STANDARD APPLICATIONS

inserts		page:
CD	40 poles + ⊕	70
CDD	72 poles + ⊕	79
CDS	27 poles + ⊕	-
CDSH	27 poles + ⊕	88
CNE	16 poles + ⊕	112
CSE	16 poles + ⊕	-
CSH	16 poles + ⊕	112
CSH S	16 poles + ⊕	124
CCE	16 poles + ⊕	132
CMSH, CMCE	6+2 (aux) poles + ⊕	138 - 139
CSS	16 poles + ⊕	150
CT, CTSE (16A) *)	16 poles + ⊕	162
CQE	32 poles + ⊕	170
CQEE	40 poles + ⊕	176
CP	6 poles + ⊕	178
CX	6/12, 6/36 and 12/2 poles + ⊕	197 - 199
CX	4/0 and 4/2 poles + ⊕	200 - 201
MIXO	4 modules	232 - 287

\*) only for standard insulating version TCHI

## hoods with double lever top entry



## covers

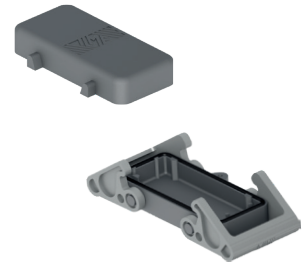

description	part No.	entry M	part No. (with eyelet)	part No. (with loop)
with thermoplastic levers and gasket, high construction	<b>TMAV 16 G32</b>	32		
with thermoplastic levers and gasket, high construction	<b>TMAV 16 G40</b>	40		
with 4 pegs			<b>TCHC 16</b>	<b>TCHC 16 S</b>
with 2 thermoplastic levers and gasket				<b>TCHC 16 G</b>

### TMAV G

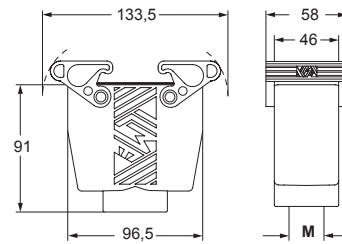

### TCHC (S)

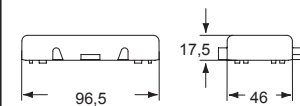

### TCHC G

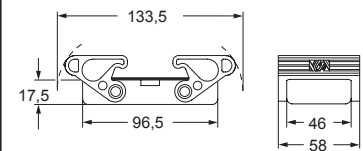

For fixing on housings

eyelet

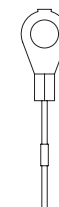

For fixing on hoods

loop

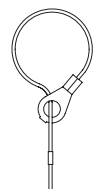

**CAVUS**® Type 12



ambient temperature limits -40 °C / +90 °C

# T-TYPE insulating STANDARD APPLICATIONS

inserts		page:
CD	64 poles + ⊕	72
CDD	108 poles + ⊕	81
CDS	42 poles + ⊕	-
CDSH	42 poles + ⊕	89
CNE	24 poles + ⊕	113
CSE	24 poles + ⊕	-
CSH	24 poles + ⊕	113
CSH S	24 poles + ⊕	125
CCE	24 poles + ⊕	133
CMSH	10+2 (aux) poles + ⊕	140
CMCE	10+2 (aux) poles + ⊕	141
CSS	24 poles + ⊕	151
CT, CTSE (16A) *)	24 poles + ⊕	163
CQE	46 poles + ⊕	171
CQEE	64 poles + ⊕	177
CX	4/8 and 6/6 poles + ⊕	204 and 206
MIXO	6 modules	232 - 287

\*) only for standard insulating version TCHI

## housings with double lever

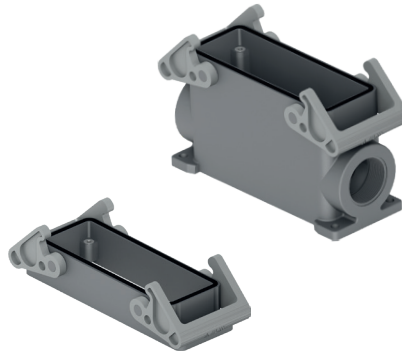

## hoods with 4 pegs



description	part No.	entry M	part No.	entry M
bulkhead mounting housing with thermoplastic levers	<b>TCHI 24</b>			
surface mounting housing, thermoplastic levers, high construction	<b>TMAP 24.32</b>	32		
surface mounting housing, thermoplastic levers, high construction	<b>TMAP 24.40</b>	40		
with pegs, side entry, high construction			<b>TMAO 24.32</b>	32
with pegs, side entry, high construction			<b>TMAO 24.40</b>	40
with pegs, top entry, high construction			<b>TMAV 24.32</b>	32
with pegs, top entry, high construction			<b>TMAV 24.40</b>	40

## panel cut-out for bulkhead mounting housings

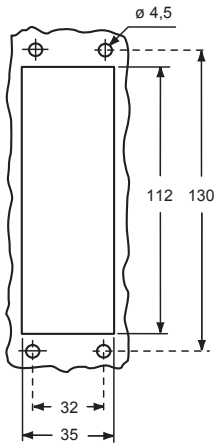

## TCHI

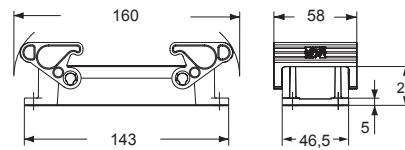

## TMAP

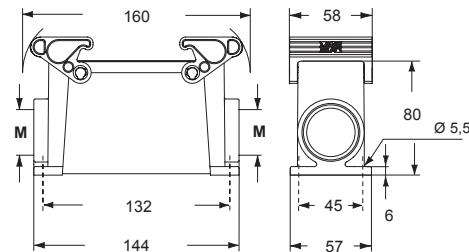

The surface mounting, high construction housings are supplied with an open threaded entry and diametrically opposite a closed threaded entry which can be opened by the user if required (with suitable tool).

## TMAO

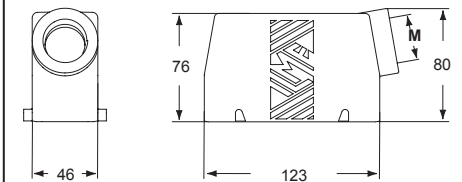

## TMAV

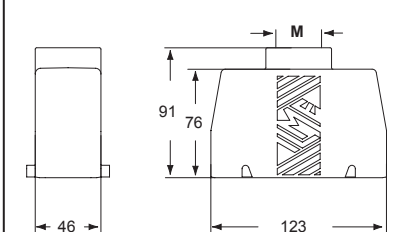

**CAIUS**® Type 12



ambient temperature limits -40 °C / +90 °C

T-TYPE STANDARD

# T-TYPE insulating STANDARD APPLICATIONS

inserts		page:
CD	64 poles + ⊕	72
CDD	108 poles + ⊕	81
CDS	42 poles + ⊕	-
CDSH	42 poles + ⊕	89
CNE	24 poles + ⊕	113
CSE	24 poles + ⊕	-
CSH	24 poles + ⊕	113
CSH S	24 poles + ⊕	125
CCE	24 poles + ⊕	133
CMSH	10+2 (aux) poles + ⊕	140
CMCE	10+2 (aux) poles + ⊕	141
CSS	24 poles + ⊕	151
CT, CTSE (16A) *)	24 poles + ⊕	163
CQE	46 poles + ⊕	171
CQEE	64 poles + ⊕	177
CX	4/8 and 6/6 poles + ⊕	204 and 206
MIXO	6 modules	232 - 287

\*) only for standard insulating version TCHI

## hoods with double lever top entry

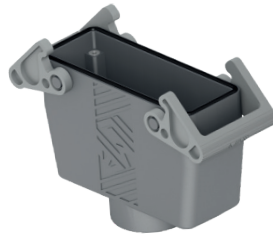

## covers

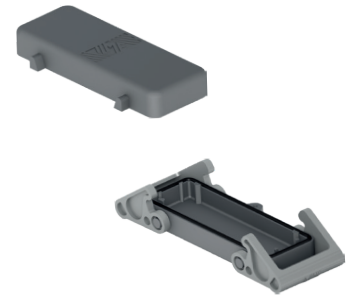

description	part No.	entry M	part No. (with eyelet)	part No. (with loop)
with thermoplastic levers and gasket, high construction	<b>TMAV 24 G32</b>	32		
with thermoplastic levers and gasket, high construction	<b>TMAV 24 G40</b>	40		
with 4 pegs			<b>TCHC 24</b>	<b>TCHC 24 S</b>
with 2 thermoplastic levers and gasket				<b>TCHC 24 G</b>

### TMAV G

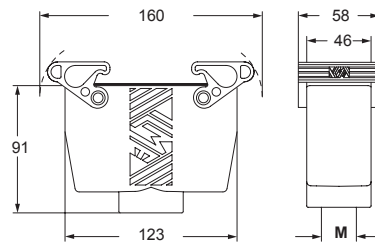

### TCHC (S)

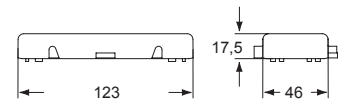

### TCHC G

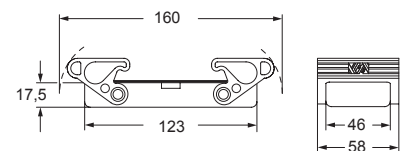

For fixing on housings

eyelet

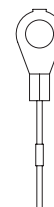

For fixing on hoods

loop

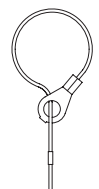

**CAIUS** Type 12



ambient temperature limits -40 °C / +90 °C

## T-TYPE/W

### Aggressive environments

#### AGGRESSIVE ENVIRONMENTS

##### SUM-UP

- ☐ Enclosures in thermoplastic material, dark grey RAL 7012 colour, with high thicknesses providing structural solidity and durability.
- ☐ Built-in FKM fluoroelastomer sealing gaskets.
- ☐ Locking levers in thermoplastic material colour grey RAL 7001.
- ☐ M25, M32 and M40 threaded cable entries.
- ☐ IP66/IP69 degree of protection according to EN 60529.
- ☐ UL TYPE 12 degree of protection according to ANSI/UL50.
- ☐ Each enclosure carries its own part number, thread size and conformity markings and UL type rating.
- ☐ Ambient temperature range: -40 °C / +90 °C.

**Q NOTE:** As the characterizing element of the T-TYPE/W series is the different sealing gasket material, hoods and covers without sealing gaskets for this series are the same of T-TYPE Standard.





# T-TYPE / W insulating AGGRESSIVE ENVIRONMENTS

inserts		page:
CDD	24 poles + ⊕	76
CDS	9 poles + ⊕	-
CDSH	9 poles + ⊕	86
CDSH NC	6 poles + ⊕	95
CNE	6 poles + ⊕	110
CSE	6 poles + ⊕	-
CSH	6 poles + ⊕	110
CSH S	6 poles + ⊕	122
CCE	6 poles + ⊕	130
CSS	6 poles + ⊕	148
CT, CTSE (16A) *)	6 poles + ⊕	160
CQE	10 poles + ⊕	168
MIXO	2 modules	232 - 28

\*) only for standard insulating version THIW

## housings with single lever FKM gasket

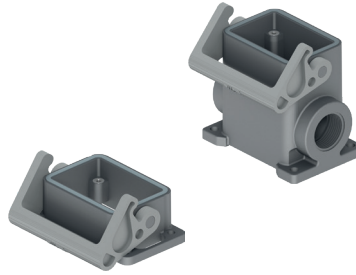

## hoods with single lever, top entry covers FKM gasket



description	part No.	entry M	part No.	part No. (with loop)
bulkhead mounting housing with thermoplastic lever	<b>THIW 06 L</b>			
surface mounting housing, thermoplastic lever, high construction	<b>TAPW 06 L25</b>	25		
surface mounting housing, thermoplastic lever, high construction	<b>TAPW 06 L32</b>	32		
with thermoplastic lever and gasket, high construction			<b>TAVW 06 LG25</b>	25
with thermoplastic lever and gasket, high construction			<b>TAVW 06 LG32</b>	32
cover with thermoplastic lever and gasket				<b>THCW 06 LG</b>

panel cut-out for bulkhead mounting housings

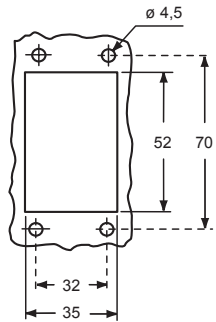

**Hoods  
TMAO  
(page 480)**



**Hoods  
TMAV  
(page 480)**

**Covers  
with eyelet  
TCHC L  
TCHC SL  
(page 481)**



### THIW L

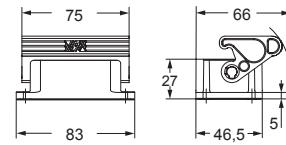

### TAPW L

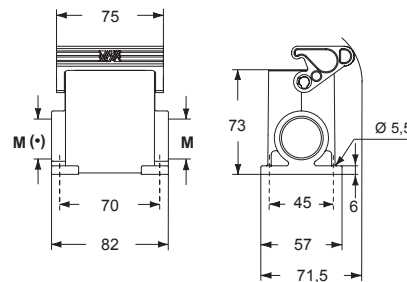

(\*) The surface mounting, high construction housings are supplied with an open threaded entry (\*) and diametrically opposite a closed threaded entry which can be opened by the user if required (with suitable tool).

### TAVW LG

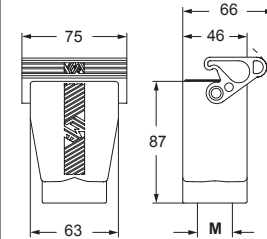

### THCW LG

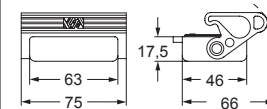

For fixing on hoods

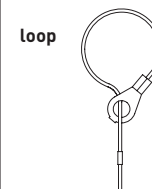

**CEC**® Type 12



ambient temperature limits -40 °C / +90 °C

# T-TYPE / W insulating AGGRESSIVE ENVIRONMENTS

inserts		page:
CDD	42 poles + ⊕	78
CDS	18 poles + ⊕	-
CDSH	18 poles + ⊕	87
CNE	10 poles + ⊕	111
CSE	10 poles + ⊕	-
CSH	10 poles + ⊕	111
CSH S	10 poles + ⊕	123
CCE	10 poles + ⊕	131
CMSH	3+2 (aux) poles + ⊕	136
CMCE	3+2 (aux) poles + ⊕	137
CSS	10 poles + ⊕	149
CT, CTSE (16A) *)	10 poles + ⊕	161
CQE	18 poles + ⊕	169
CX	8/24 poles + ⊕	194
MIXO	3 modules	232 - 287

\*) only for standard insulating version THIW

## housings with double lever FKM gasket

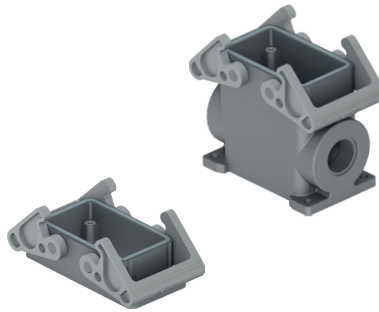

## hoods with double lever, top entry covers FKM gasket

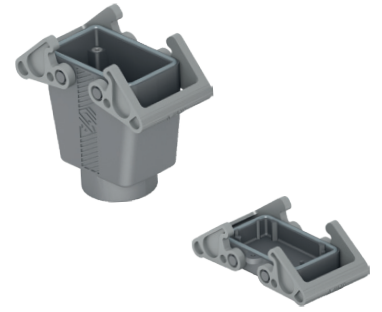

description	part No.	entry M	part No.	part No. (with loop)
bulkhead mounting housing with thermoplastic levers	<b>THIW 10</b>			
surface mounting housing, thermoplastic levers, high construction	<b>TAPW 10.25</b>	25		
surface mounting housing, thermoplastic levers, high construction	<b>TAPW 10.32</b>	32		
with thermoplastic levers and gasket, high construction			<b>TAVW 10 G25</b>	25
with thermoplastic levers and gasket, high construction			<b>TAVW 10 G32</b>	32
cover with 2 thermoplastic levers and gasket				<b>THCW 10 G</b>

panel cut-out for bulkhead mounting housings

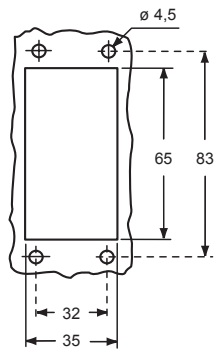

**Hoods  
TMAO  
(page 482)**

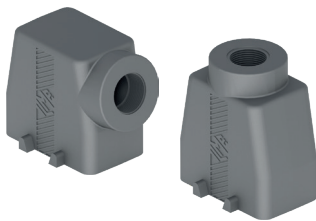

**Hoods  
TMAV  
(page 482)**

**Covers  
with eyelet  
TCHC  
TCHC S  
(page 483)**



### THIW

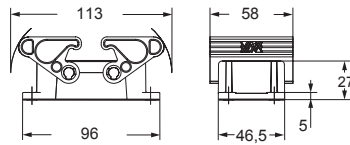

### TAPW

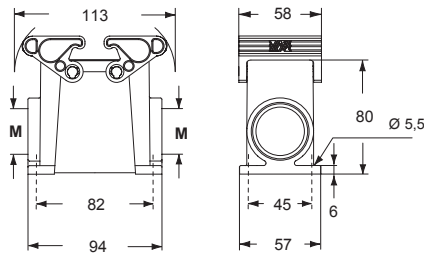

The surface mounting, high construction housings are supplied with an open threaded entry and diametrically opposite a closed threaded entry which can be opened by the user if required (with suitable tool).

### TAVW G

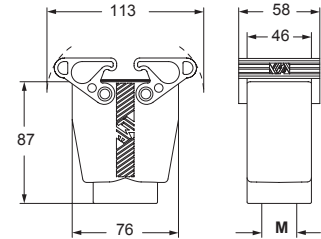

### THCW G

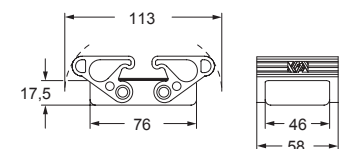

**For fixing on hoods**

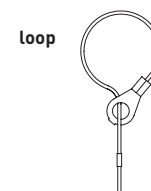

**CAIUS** Type 12



ambient temperature limits -40 °C / +90 °C

# T-TYPE / W insulating AGGRESSIVE ENVIRONMENTS

inserts		page:
CD	40 poles + ⊕	70
CDD	72 poles + ⊕	79
CDS	27 poles + ⊕	-
CDSH	27 poles + ⊕	88
CNE	16 poles + ⊕	112
CSE	16 poles + ⊕	-
CSH	16 poles + ⊕	112
CSH S	16 poles + ⊕	124
CCE	16 poles + ⊕	132
CMSH, CMCE	6+2 (aux) poles + ⊕	138 - 139
CSS	16 poles + ⊕	150
CT, CTSE (16A) *)	16 poles + ⊕	162
CQE	32 poles + ⊕	170
CQEE	40 poles + ⊕	176
CP	6 poles + ⊕	178
CX	6/12, 6/36 and 12/2 poles + ⊕	197 - 199
CX	4/0 and 4/2 poles + ⊕	200 - 201
MIXO	4 modules	232 - 287

\*) only for standard insulating version THIW

## housings with double lever FKM gasket

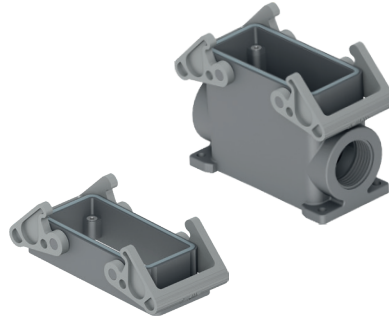

## hoods with double lever, top entry covers FKM gasket



description	part No.	entry M	part No.	part No. (with loop)
bulkhead mounting housing with thermoplastic levers	<b>THIW 16</b>			
surface mounting housing, thermoplastic levers, high construction	<b>TAPW 16.32</b>	32		
surface mounting housing, thermoplastic levers, high construction	<b>TAPW 16.40</b>	40		
with thermoplastic levers and gasket, high construction			<b>TAVW 16 G32</b>	32
with thermoplastic levers and gasket, high construction			<b>TAVW 16 G40</b>	40
cover with 2 thermoplastic levers and gasket				<b>THCW 16 G</b>

### panel cut-out for bulkhead mounting housings

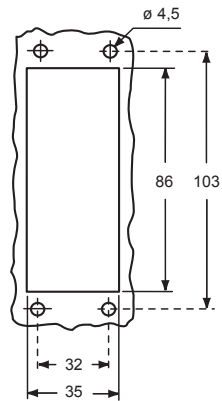

Hoods  
**TMAO**  
(page 484)

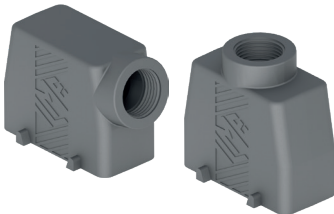

Hoods  
**TMAV**  
(page 484)

Covers  
with eyelet  
**TCHC**  
**TCHC S**  
(page 485)



### THIW

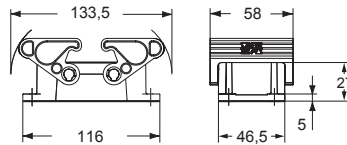

### TAPW

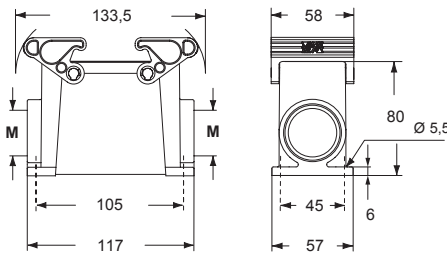

The surface mounting, high construction housings are supplied with an open threaded entry and diametrically opposite a closed threaded entry which can be opened by the user if required (with suitable tool).

### TAVW G

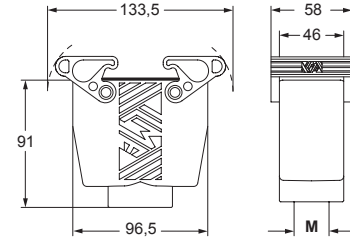

### THCW G

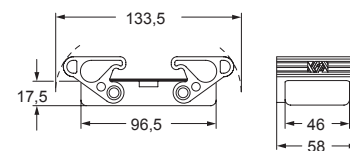

### For fixing on hoods

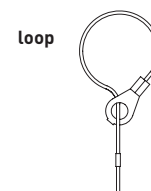

**CE** **RU** **US** Type 12



ambient temperature limits -40 °C / +90 °C

# T-TYPE / W insulating AGGRESSIVE ENVIRONMENTS

inserts		page:
CD	64 poles + ⊕	72
CDD	108 poles + ⊕	81
CDS	42 poles + ⊕	-
CDSH	42 poles + ⊕	89
CNE	24 poles + ⊕	113
CSE	24 poles + ⊕	-
CSH	24 poles + ⊕	113
CSH S	24 poles + ⊕	125
CCE	24 poles + ⊕	133
CMSH	10+2 (aux) poles + ⊕	140
CMCE	10+2 (aux) poles + ⊕	141
CSS	24 poles + ⊕	151
CT, CTSE (16A) *	24 poles + ⊕	163
CQE	46 poles + ⊕	171
CQEE	64 poles + ⊕	177
CX	4/8 and 6/6 poles + ⊕	204 and 206
MIXO	6 modules	232 - 287

\*) only for standard insulating version THIW

## housings with double lever FKM gasket

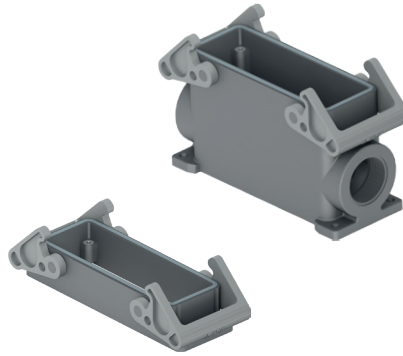

## hoods with double lever, top entry covers FKM gasket

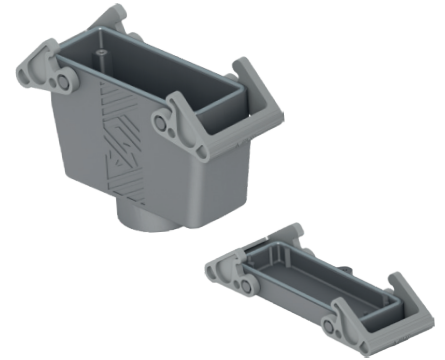

description	part No.	entry M	part No.	part No. (with loop)
bulkhead mounting housing with thermoplastic levers	<b>THIW 24</b>			
surface mounting housing, thermoplastic levers, high construction	<b>TAPW 24.32</b>	32		
surface mounting housing, thermoplastic levers, high construction	<b>TAPW 24.40</b>	40		
with thermoplastic levers and gasket, high construction			<b>TAVW 24 G32</b>	32
with thermoplastic levers and gasket, high construction			<b>TAVW 24 G40</b>	40
cover with 2 thermoplastic levers and gasket				<b>THCW 24 G</b>

panel cut-out for bulkhead mounting housings

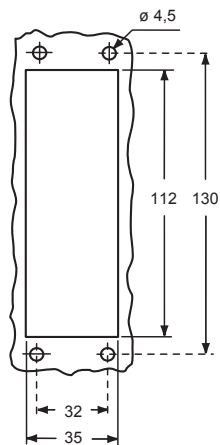

**Hoods  
TMAO  
(page 486)**



**Hoods  
TMAV  
(page 486)**

**Covers  
with eyelet  
TCHC  
TCHC S  
(page 487)**



### THIW

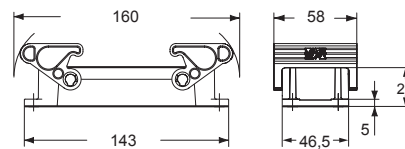

### TAPW

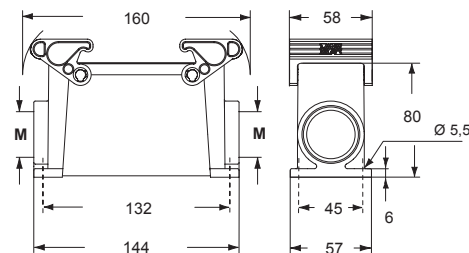

The surface mounting, high construction housings are supplied with an open threaded entry and diametrically opposite a closed threaded entry which can be opened by the user if required (with suitable tool).

### TAVW G

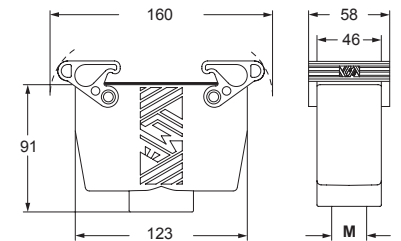

### THCW G

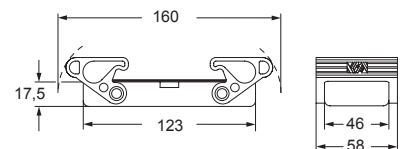

**For fixing on hoods**

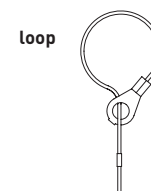

**CAIUS**® Type 12



ambient temperature limits -40 °C / +90 °C

# T-TYPE HYGIENIC

## Resistance of materials to detergents/disinfectants used in the food industry



ILME T-TYPE/H and T-TYPE/C enclosure materials have been selected to guarantee compatibility with the principal alkaline or acid detergents and disinfectants used in the food industry. In particular, series T-TYPE/H

and T-TYPE/C enclosures have been tested according to protocol **F&E/ P3-E n. 40-1** by Ecolab, leading multinational in the detergent sector, to verify their compatibility with the following cleaning fluids:

- |  |  |
|--|--|
| <ul style="list-style-type: none"> <li>● <b>Acid foaming detergents:</b> P3-topax 52, Topaz AC5, P3-topmaxx 520 and P3-topax 56.</li> <li>● <b>Alkaline foaming detergents:</b> P3-topax 19, Topaz MD3 and Ecofoam Basic.</li> <li>● <b>Strong alkaline foaming detergents:</b> P3-topax 36, Topaz HD1 and P3-topax 30.</li> </ul> | <ul style="list-style-type: none"> <li>● <b>Alkaline-chloride foaming detergents-disinfectants:</b> P3-topax 66, Ecofoam CL and P3-topax M95.</li> <li>● <b>Non-foaming peracetic based disinfectants:</b> P3-oxonia active, P3-topactive OKT0 and P3-topactive DES.</li> <li>● <b>Neutral disinfectants:</b> P3-topax 990 and P3-topax 91.</li> </ul> |
|--|--|
- 
- Full immersion of parts in detergent/disinfectant solutions.
  - Water hardness of 200ppm CaCO<sub>3</sub>
  - Tests performed at concentrations 30% higher than those normally recommended in technical data sheets.
  - Test duration (each detergent): 28 days at 20 °C (equivalent to 6 years of daily cleaning).
  - Test solution renewed every 3-4 days for oxidizing products (P3-oxonia active, P3-topactive OKT0, P3-topax 66).
  - Test results evaluation: ISO 4068-1 (esthetic appearance and mass loss).

### Cleanability and degrees of protection used in the food industry

#### ECOLAB F&E/P3-E n. 40-1 Test Protocol see declaration of compatibility at pages 494-495

Series T-TYPE/H and T-TYPE/C enclosures have been designed to facilitate cleaning of surfaces that could potentially come into contact with food. For this purpose **Series T-TYPE/H and T-TYPE/C** enclosures have **IP65 and IP69 degrees of protection as per IEC 60529 Edition 2.2 (2013-08)** to allow jet washing, as typically used in the food industry.

The suitability of ILME products for the **cleanability** requirements stated by Machinery Directive 2006/42/EC for both Splash and Food Area zones (EN 1672-2 and EN ISO 14159) **depends on the specific installation of ILME products on the machine and must be evaluated by the machine manufacturer.**

In addition to the Hygienic version, aluminium enclosures are also available with degrees of protection up to IP68 (check for possible applicability).

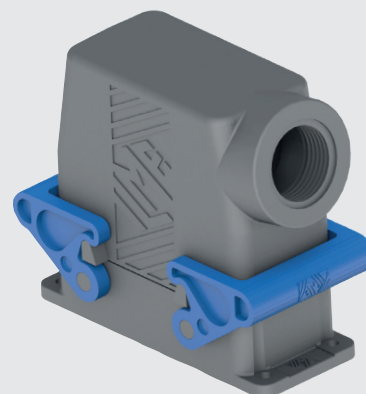
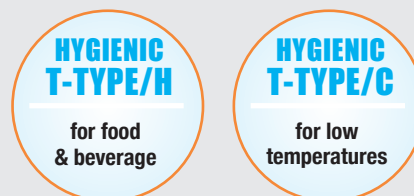

Declaration of compatibility - By courtesy of ECOLAB s.r.l.



**DECLARATION OF COMPATIBILITY**  
between ECOLAB hygiene products  
and ILME enclosures for multiple connectors

**For the completely safe cleaning of your plant**



The ideal partner for Industrial Connections for power supply of plug connected devices, connections for auxiliary circuits and automation control:

T-type H and T-type C enclosures



The declaration proves the high resistance of these enclosures to Ecolab products commonly and worldwide used in Food and Beverage Industries.

ILME S.p.a.  
Via Marco Antonio Colonna, 9 - 20149 Milano (MI)  
www.ilme.com



Supplier of hygiene solutions for Food and Beverage industries

**Products**



**Equipments**



**Services**

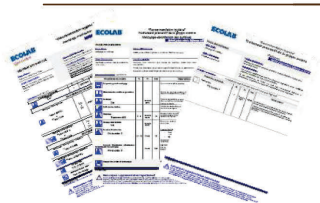

Ecolab s.r.l.  
Via Paracelso 6 - 20864 Agrate Brianza (MB)  
www.it.ecolab.eu

T-TYPE HYGIENIC





### Compatible products with T-type/C and T-type/H ILME enclosures

See below for the test procedure

PRODUCT	%	T-TYPE ENCLOSURE	DEFECT QUANTITY	DEFECT QUALITY	COLOR VARIATION
P3-topax 52 - Topaz AC5	6	C and H	0	0	0
P3-topax 19 - Topaz MD3	6	C and H	0	0	0
P3-topax 36 - Topaz HD1	6	C and H	0	0	0
P3-topax 91	6	C and H	0	0	0
P3-topax 990	6	C and H	0	0	0
P3-oxonia active	1	C and H	0	0	0
P3-topactive okto	3	C and H	0	0	0
P3-topax 66	6	C and H	0	0	0

DEFECT QUANTITY: 0 means - No detectable defect  
 DEFECT QUALITY: 0 means - Up to 10x magnification no detectable defect  
 COLOR VARIATION: 0 means - Unchanged, no discoloration

### Test procedure

- Test performed by Ecolab Technical Application Service
- Ecolab reference method 40.1 – ISO 4068-1 for the evaluation
- Full immersion of parts in detergent/disinfectant solutions
- Water hardness of 200ppm CaCO<sub>3</sub>
- 28 days total time at 20°C (equivalent to the contact time that occurs in 6 years of daily cleaning)
- Concentrations tested 30% higher than those normally recommended
- Test solution renewed every 3-4 days for oxidizing products (P3-oxonia active, P3-topactive OKTO, P3-topax 66)

### Final statement

- The Ecolab Technical Application Service Italy certifies that the ILME enclosures for multipole connectors T-type/C and T-type/H are perfectly compatible with the above listed Ecolab detergents and disinfectants used in a concentration 30% higher than those normally recommended.

February 2016

## HYGIENIC

### Requirements on materials in contact or that may come into contact with food products

T-TYPE/H and T-TYPE/C materials have been selected to satisfy the requirements of EHEDG Guideline n° 32 "Materials of construction for food equipment in contact with food" and point 2.1.1, letter a) in Annex I of the Machinery Directive 2006/42/EC. Paragraph 91 of the Guide to the application of Machinery Directive 2006/42/EC specifies that the reference at Annex I, point 2.1.1, letter a) of the directive must be considered as a reference to EC regulation n. 1935/2004 and directive 2002/72/EC.

EU commission regulation n. 10/2011 dated 14 January 2011, concerning plastic material and objects designed for contact with food products, is a specific measure as provided for by article 5, paragraph 1 of the above-mentioned EC regulation n. 1935/2004.

It defines specific regulations for plastic materials and objects in order to guarantee their use in safe conditions and supersedes commission directive 2002/72/EC dated 6 August 2002 on plastic materials and objects designed for contact with food products. Art. 2, section 2 of the above-mentioned EU regulation n. 10/2011 specifies that rubber and silicone do not fall within the field of application of the regulation. EU regulation n. 10/2011 provides for the use of materials in positive lists of technological monomers, additives and adjuvants and the passing of global and specific migration tests in food simulants.

ILME T-Type/H and T-Type/C series enclosure materials have been selected according to EU n. 10/2011 regulation requirements and each component has been tested according to EU regulation n. 10/2011 and EC regulation n. 1935/2004.

Furthermore, T-Type/H and T-Type/C series gasket materials have been formulated according to FDA Guideline 21 CFR §177.2600 and T-Type enclosures and levers materials complying with FDA, 21 CFR, §177.1520 (a)(3)(i)(c)(1), (b) and (c)3.1a.



# HYGIENIC

## Risk Assessment and Critical Control Points in the food industry

Companies that work in the food sector must implement HACCP, i.e. Hazard Analysis and Critical Control Points system (EC Regulation 852/2004 on food product hygiene in force since 01/01/2006) and can voluntarily apply for various certificates (ISO 22000, BRC, ISF, etc.).

All those involved in primary food production (harvesting, milking, breeding), its preparation, transformation, manufacturing, packaging, storage, transport, distribution, handling, sales or supply, including consumer catering, are required to implement an HACCP system, i.e. a series of procedures aimed at preventing food contamination hazards. HACCP is based on monitoring food processing points where biological, chemical or physical contamination hazards may arise. In 2006, HACCP was made mandatory for companies that deal with the food for animals (production of raw materials, mixtures and additives).

A company required to implement HACCP can initially divide its food processing machinery into three zones from the point of view of risk for food product hygiene. The choice of the zone in which the wiring and connectors are installed depends on the risk assessment the manufacturer must conduct as per Machinery Directive 2006/42/EC which, in chapter 2.1, sets out the additional requirements for the food industry (see Table 1).

**Table 1. According to EN 1672-2:2009 - Food processing machinery - Basic concepts - Part 2: Hygiene requirements**

Application Zones	Zone Requirements	Usable Products
No Food Area: Zone where there is <u>no contact risk</u> with food.	<u>No additional requirement</u> for the food industry.	Enclosures series T-TYPE, T-TYPE/W, C-TYPE, BIG, IP68, C7 IP67, W-TYPE, EMC, COB, ...
Splash Area: Zone where <u>components may come into contact with food</u> but <u>there is no risk</u> that the food that came into contact with the components in this area <u>returns to the production cycle</u> .	In this zone, <u>components</u> also come into contact with cleaning agents used in the food industry and <u>must therefore be cleanable and resistant to the washing process</u> (see "Resistance of materials to detergents/ disinfectants used in the food industry" and "Cleanability and degrees of protection used in the food industry").	New <u>Hygienic</u> version enclosures series <u>T-TYPE/H and T-TYPE/C</u> .
Food Area: Zone where <u>components may come into contact with food</u> , with the risk that the food that came into contact with the components in this area <u>returns to the production cycle</u> .	In this zone, in addition to complying with the cleanability and washing requirements, the <u>components</u> are also subject to a series of more <u>stringent requirements</u> aimed at making negligible the <u>risk of food contamination</u> in the process (see paragraph "Requirements on materials in contact or that may come into contact with food products").	For more information about T-TYPE/C in special version, please contact our Offices.

# HYGIENIC

## T-TYPE/H & T-TYPE/C

### The evolution of T-TYPE insulating enclosures meets food and beverage requirements



The new Hygienic multi-pole connector enclosures version (series T-TYPE/H and T-TYPE/C) has been designed for installation on food industry machines and systems.

For this purpose, the following improvements to the T-Type series have been made in order to satisfy the requirements laid down by chapter 2.1 of Machinery Directive 2006/42/EC for the machines on which they are installed:

- material cleanability and resistance to the cleaning and sanitising agents normally used in the food industry;
- materials in terms of the requirements for accidental contact with food products.

The T-TYPE/H and T-TYPE/C series enclosures fit different sealing gaskets.

For T-Type/H series enclosures, the sealing gasket is in HNBR rubber, a material with excellent resistance to both acidic and alkaline detergents as well as any animal and vegetable fats it could come into contact with in food industry applications.

For T-Type/C series enclosures, the sealing gasket is made by silicone rubber, a material with good resistance to acidic and alkaline detergents as well as animal and vegetable fats. It is also characterised by its improved resistance to low temperatures (series suitable for uses as low as -50 °C), conditions that can arise in food industries that use the cold chain.

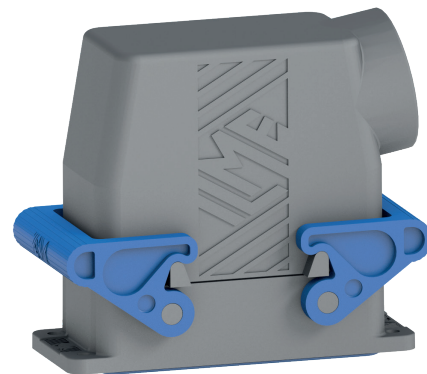

A dedicated variant of this new Hygienic version may be used where a high risk of accidental contact with food is occurring during production (see Table 1, Application Zones, Food Area). For more information about this possible special version, please contact our Offices.

In accordance with the requirements set forth in EHEDG Guideline n. 32 "Materials of construction for food equipment in contact with food" (EHEDG = European Hygienic Engineering & Design Group), the closing levers and sealing gaskets are coloured blue to easily identify any accidental contaminations in food products and to facilitate the visual identification of their complete cleanliness.

For this purpose, the following improvements to the T-TYPE series have been made in order to satisfy the requirements laid down by chapter 2.1 of **Machinery Directive 2006/42/EC** for the machines on which they are installed:

- material cleanability and resistance to the cleaning and sanitising agents normally used in the food industry;

- materials in terms of the requirements for accidental contact with food products.

## T-TYPE/H - PRODUCTION LINES APPLICATIONS

### SUM-UP

- ☑ Enclosures in thermoplastic material, dark grey RAL 7012 colour, with high thicknesses providing structural solidity and durability.
- ☑ Sealing gaskets made by HNBR rubber formulated in accordance with FDA Guideline 21 CFR §177.2600.
- ☑ Levers in thermoplastic material, blue RAL 5015 colour.
- ☑ M25, M32 and M40 threaded cable entries.
- ☑ IP65 and IP69 degree of protection according to EN 60529.
- ☑ Each enclosure carries its own part number, thread/size and conformity markings.
- ☑ Ambient temperature range: -40 °C / +70 °C

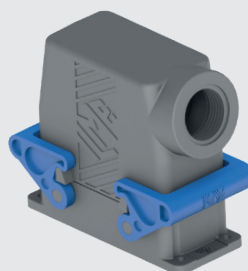

## T-TYPE/C - LOW TEMPERATURE APPLICATIONS

### SUM-UP

- ☑ Enclosures in thermoplastic material, dark grey RAL 7012
- ☑ The Hygienic T-TYPE/C Series enclosures have been specifically designed for food and beverage ambient temperature as low as -50 °C (range: -50 °C / +70 °C).
- ☑ Enclosures in thermoplastic material, dark grey RAL 7012 colour, with high thicknesses providing structural solidity and durability.
- ☑ This version differs from the Hygienic T-TYPE/H one for the sealing gaskets made by in accordance with FDA Guideline 21 CFR §177.2600.
- ☑ ILME T-TYPE/C series enclosure materials have been selected according to EU n. 10/2011 regulation requirements and each component has been tested according to EU regulation n. 10/2011 and EC regulation n. 1935/2004.

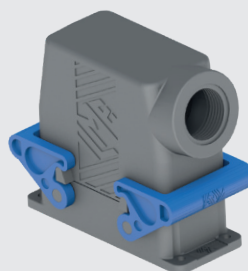

**Q NOTE:** As the characterizing elements of the Hygienic Series are the different sealing gasket material and the different locking lever, hoods and covers without sealing gaskets and locking levers are the same of series T-TYPE Standard.

# HYGIENIC

## T-TYPE/H & T-TYPE/C

### FOCUS ON:

#### 1 Construction

By using the BC-MUL® moulding technique together with the use of MIL.BOX® material, **these enclosures are structurally solid and mechanically robust**, due to their increased thickness. They are particularly resistant to the main pollutants present in industrial environments. The lever enclosure pegs are built into the enclosures. The methods for fastening the connectors to the enclosures are made by M3 threaded metal inserts. With reference to metal construction, which to comply with electrical installation safety norms, must be earthed via a metal connection to the protective earth terminal of the connector inserts inside the enclosure, **the new series of enclosures offers a solution for total insulation constructions** ☐ (equivalent to class II) where necessary.

The thermoplastic material used is RAL 7012 dark grey colour and has passed **glow wire** testing in accordance with the IEC (EN) 60695-2-11 at **650 °C** in compliance with intended uses.

#### 2 Gaskets

Gaskets have been produced in **HNBR rubber or SILICONE rubber** and have been incorporated in the base flange on bulkhead mounting housings for easier installation.

#### 3 Levers

The locking levers have been produced in **self-extinguishing thermoplastic material**, blue RAL 5015 colour. In accordance with the requirements set forth in **EHEDG Guideline n. 32** "Materials of construction for food equipment in contact with food" (EHEDG = European Hygienic Engineering & Design Group), the closing levers and sealing gaskets are coloured blue to easily identify any accidental contaminations in food products and to facilitate the visual identification of their complete cleanliness.

#### 4 Dimensions

The internal dimensions allow mounting of all connector inserts in their relevant sizes. The external dimensions of the bulkhead mounting housings are similar to those of the corresponding metallic enclosures; hole fixing centres are unchanged. Hoods offer an inner cabling space similar to that of the "high" construction models of the corresponding metal enclosures. Other characteristics are in compliance with the applicable safety standard for electrical connectors, **IEC/EN 61984**.

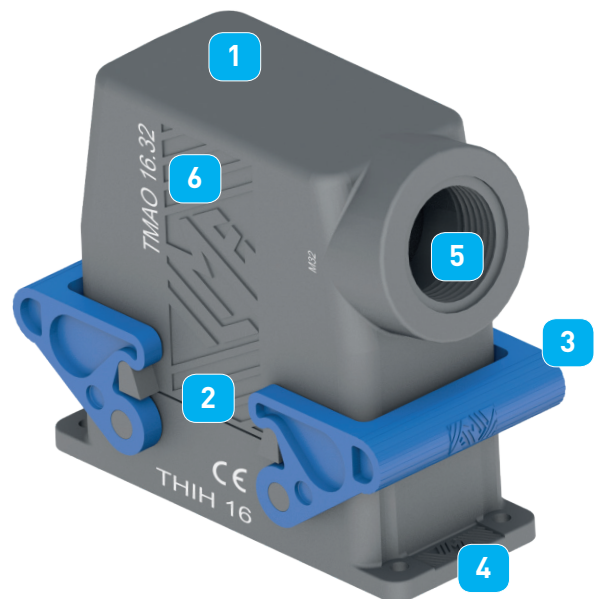

#### 5 Cable entries

The housing and hood cable entries are available with metric thread, respectively:

- **M25 or M32** for smaller sizes "44.27" and "57.27".
- **M32 or M40** for larger sizes "77.27" and "104.27".

The surface mounting, high construction housings are supplied with an open threaded entry and diametrically opposite a closed threaded entry which can be opened by the user if required (with suitable tool).

The recent standard **IEC/EN 61076-7-100** regarding metric cable entries for multipole electrical connectors for heavy duty uses, which standardises some main dimensions for entries and their related accessories (gaskets, pressure nuts), have been carefully considered in the product design.

#### 6 Markings

Each enclosure carries its own part number and conformity markings.



# T-TYPE / H production lines HYGIENIC SERIES

inserts		page:
CDD	24 poles + ⊕	76
CDS	9 poles + ⊕	-
CDSH	9 poles + ⊕	86
CDSH NC	6 poles + ⊕	95
CNE	6 poles + ⊕	110
CSE	6 poles + ⊕	-
CSH	6 poles + ⊕	110
CSH S	6 poles + ⊕	122
CCE	6 poles + ⊕	130
CSS	6 poles + ⊕	148
CT, CTSE (16A) *)	6 poles + ⊕	160
CQE	10 poles + ⊕	168
MIXO	2 modules	232 - 28

\*) only for standard insulating version THIH

## housings with single lever HNBR gasket

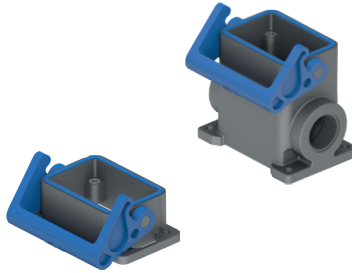

## hoods with single lever, top entry covers HNBR gasket

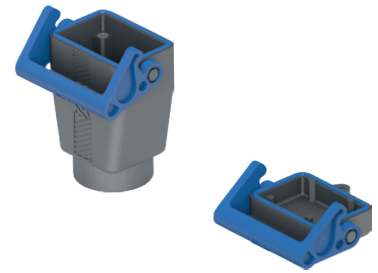

description	part No.	entry M	part No.	part No. (with loop)
bulkhead mounting housing with thermoplastic lever	<b>THIH 06 L</b>			
surface mounting housing, thermoplastic lever, high construction	<b>TAPH 06 L25</b>	25		
surface mounting housing, thermoplastic lever, high construction	<b>TAPH 06 L32</b>	32		
with thermoplastic lever and gasket, high construction			<b>TAVH 06 LG25</b>	25
with thermoplastic lever and gasket, high construction			<b>TAVH 06 LG32</b>	32
cover with thermoplastic lever and gasket				<b>THCH 06 LG</b>

panel cut-out for bulkhead mounting housings

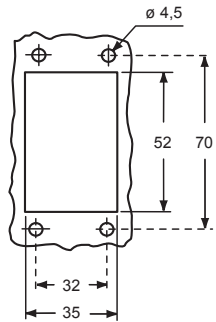

**Hoods  
TMAO  
(page 480)**



**Hoods  
TMAV  
(page 480)**

**Covers  
with eyelet  
TCHC L  
TCHC SL  
(page 481)**



**CE** **RU** <sup>®</sup> **US** Type 12



ambient temperature limits -40 °C / +70 °C

### THIH L

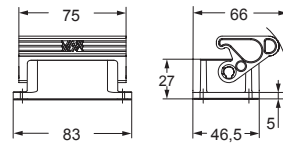

### TAPH L

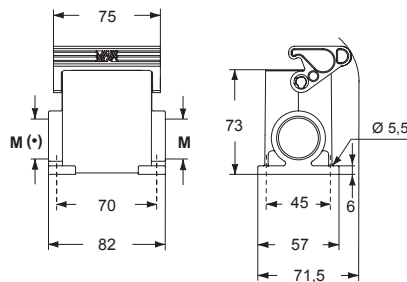

(\*) The surface mounting, high construction housings are supplied with an open threaded entry (\*) and diametrically opposite a closed threaded entry which can be opened by the user if required (with suitable tool).

### TAVH LG

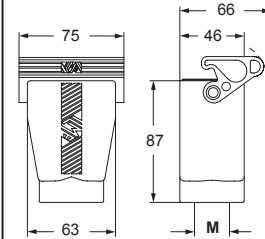

### THCH LG

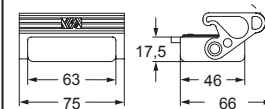

For fixing on hoods

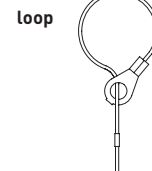

# T-TYPE / H production lines HYGIENIC SERIES

inserts		page:
CDD	42 poles + ⊕	78
CDS	18 poles + ⊕	-
CDSH	18 poles + ⊕	87
CNE	10 poles + ⊕	111
CSE	10 poles + ⊕	-
CSH	10 poles + ⊕	111
CSH S	10 poles + ⊕	123
CCE	10 poles + ⊕	131
CMSH	3+2 (aux) poles + ⊕	136
CMCE	3+2 (aux) poles + ⊕	137
CSS	10 poles + ⊕	149
CT, CTSE (16A) *)	10 poles + ⊕	161
CQE	18 poles + ⊕	169
CX	8/24 poles + ⊕	194
MIXO	3 modules	232 - 287

\*) only for standard insulating version THIH

## housings with double lever HNBR gasket

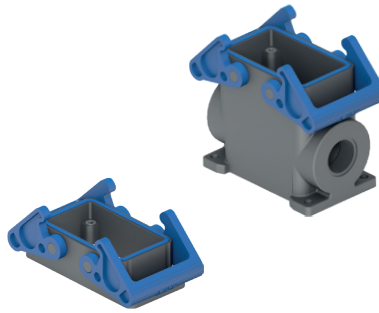

## hoods with double lever, top entry covers HNBR gasket

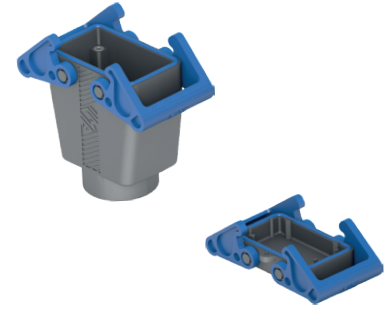

description	part No.	entry M	part No.	part No. (with loop)
bulkhead mounting housing with thermoplastic levers	<b>THIH 10</b>			
surface mounting housing, thermoplastic levers, high construction	<b>TAPH 10.25</b>	25		
surface mounting housing, thermoplastic levers, high construction	<b>TAPH 10.32</b>	32		
with thermoplastic levers and gasket, high construction			<b>TAVH 10 G25</b>	25
with thermoplastic levers and gasket, high construction			<b>TAVH 10 G32</b>	32
with 2 thermoplastic levers and gasket				<b>THCH 10 G</b>

panel cut-out for bulkhead mounting housings

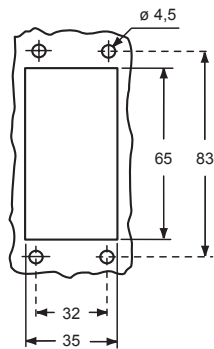

**Hoods  
TMAO  
(page 482)**

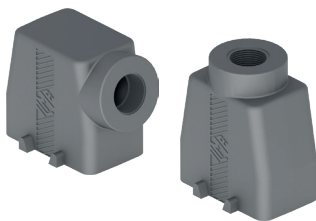

**Hoods  
TMAV  
(page 482)**

**Covers  
with eyelet  
TCHC  
TCHC S  
(page 483)**



**CAUS**® Type 12



ambient temperature limits -40 °C / +70 °C

### THIH

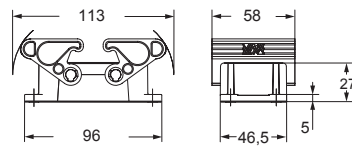

### TAPH

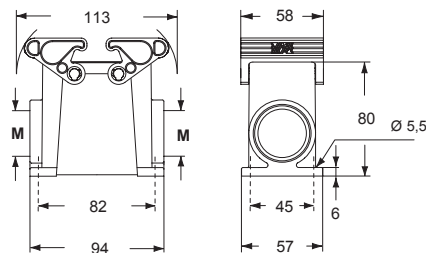

The surface mounting, high construction housings are supplied with an open threaded entry and diametrically opposite a closed threaded entry which can be opened by the user if required (with suitable tool).

### TAVH G

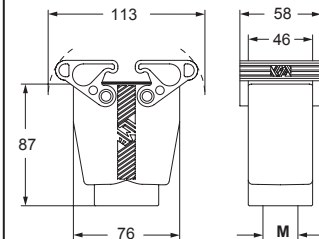

### THCH G

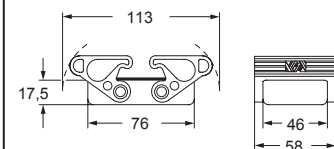

### For fixing on hoods

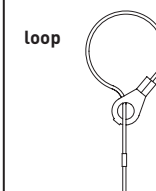

# T-TYPE / H production lines HYGIENIC SERIES

inserts		page:
CD	40 poles + ⊕	70
CDD	72 poles + ⊕	79
CDS	27 poles + ⊕	-
CDSH	27 poles + ⊕	88
CNE	16 poles + ⊕	112
CSE	16 poles + ⊕	-
CSH	16 poles + ⊕	112
CSH S	16 poles + ⊕	124
CCE	16 poles + ⊕	132
CMSH, CMCE	6+2 (aux) poles + ⊕	138 - 139
CSS	16 poles + ⊕	150
CT, CTSE (16A) *)	16 poles + ⊕	162
CQE	32 poles + ⊕	170
CQEE	40 poles + ⊕	176
CP	6 poles + ⊕	178
CX	6/12, 6/36 and 12/2 poles + ⊕	197 - 199
CX	4/0 and 4/2 poles + ⊕	200 - 201
MIXO	4 modules	232 - 287

\*) only for standard insulating version THIH

## housings with double lever HNBR gasket

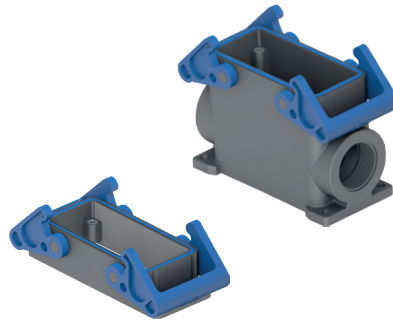

## hoods with double lever, top entry covers HNBR gasket

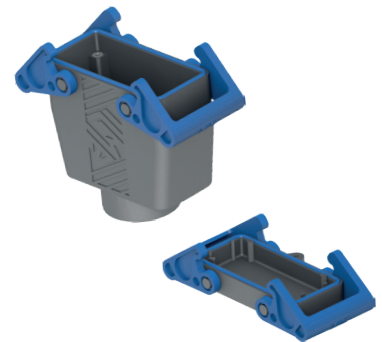

description	part No.	entry M	part No.	part No. (with loop)
bulkhead mounting housing with thermoplastic levers	<b>THIH 16</b>			
surface mounting housing, thermoplastic levers, high construction	<b>TAPH 16.32</b>	32		
surface mounting housing, thermoplastic levers, high construction	<b>TAPH 16.40</b>	40		
with thermoplastic levers and gasket, high construction			<b>TAVH 16 G32</b>	32
with thermoplastic levers and gasket, high construction			<b>TAVH 16 G40</b>	40
cover with 2 thermoplastic levers and gasket				<b>THCH 16 G</b>

panel cut-out for bulkhead mounting housings

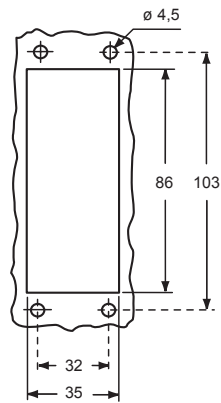

**Hoods  
TMAO  
(page 484)**

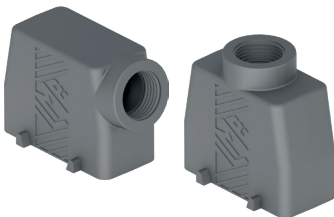

**Hoods  
TMAV  
(page 484)**

**Covers  
with eyelet  
TCHC  
TCHC S  
(page 485)**



**CE** **UL** **US** Type 12

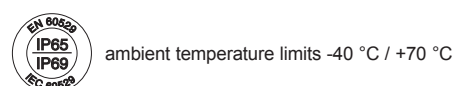

### THIH

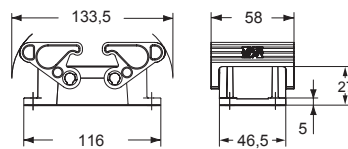

### TAPH

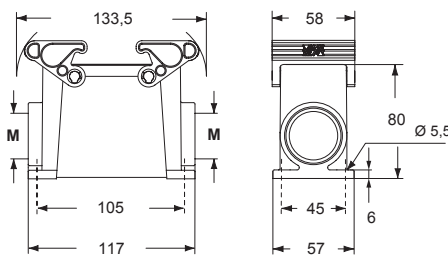

The surface mounting, high construction housings are supplied with an open threaded entry and diametrically opposite a closed threaded entry which can be opened by the user if required (with suitable tool).

### TAVH G

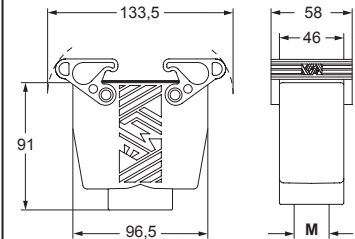

### THCH G

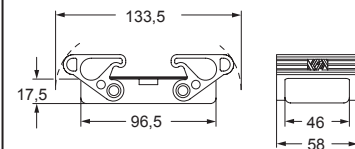

For fixing on hoods

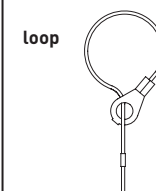

T-TYPE / H

# T-TYPE / H production lines HYGIENIC SERIES

inserts		page:
CD	64 poles + ⊕	72
CDD	108 poles + ⊕	81
CDS	42 poles + ⊕	-
CDSH	42 poles + ⊕	89
CNE	24 poles + ⊕	113
CSE	24 poles + ⊕	-
CSH	24 poles + ⊕	113
CSH S	24 poles + ⊕	125
CCE	24 poles + ⊕	133
CMSH	10+2 (aux) poles + ⊕	140
CMCE	10+2 (aux) poles + ⊕	141
CSS	24 poles + ⊕	151
CT, CTSE (16A) *	24 poles + ⊕	163
CQE	46 poles + ⊕	171
CQEE	64 poles + ⊕	177
CX	4/8 and 6/6 poles + ⊕	204 and 206
MIXO	6 modules	232 - 287

\*) only for standard insulating version THIH

## housings with double lever HNBR gasket

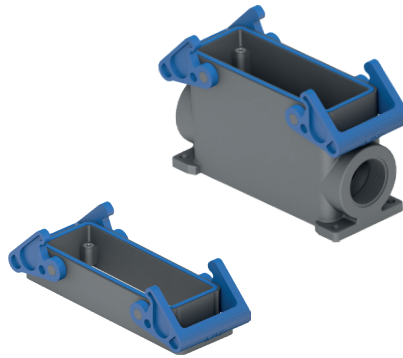

## hoods with double lever, top entry covers HNBR gasket



description	part No.	entry M	part No.	part No. (with loop)
bulkhead mounting housing with thermoplastic levers	<b>THIH 24</b>			
surface mounting housing, thermoplastic levers, high construction	<b>TAPH 24.322</b>	32		
surface mounting housing, thermoplastic levers, high construction	<b>TAPH 24.40</b>	40		
with thermoplastic levers and gasket, high construction			<b>TAVH 24 G32</b>	32
with thermoplastic levers and gasket, high construction			<b>TAVH 24 G40</b>	40
cover with 2 thermoplastic levers and gasket				<b>THCH 24 G</b>

panel cut-out for bulkhead mounting housings

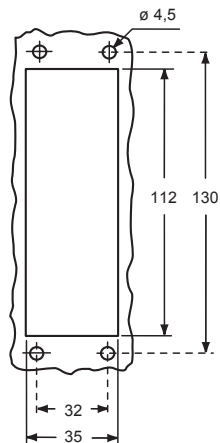

**Hoods  
TMAO  
(page 486)**



**Hoods  
TMAV  
(page 486)**

**Covers  
with eyelet  
TCHC  
TCHC S  
(page 487)**



**CAVUS**® Type 12



ambient temperature limits -40 °C / +70 °C

### THIH

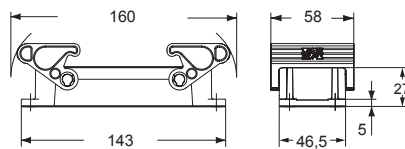

### TAPH

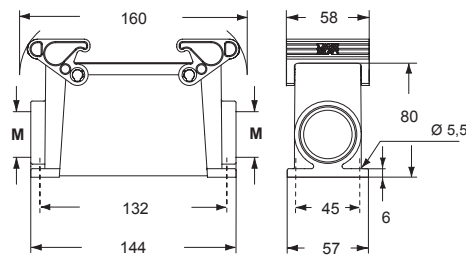

The surface mounting, high construction housings are supplied with an open threaded entry and diametrically opposite a closed threaded entry which can be opened by the user if required (with suitable tool).

### TAVH G

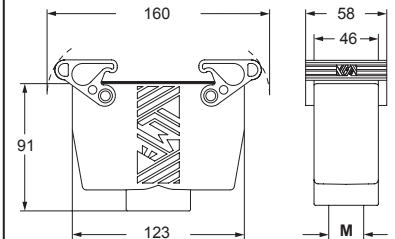

### THCH G

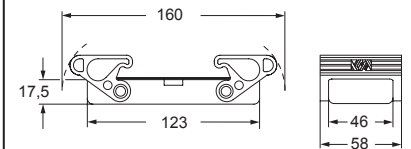

**For fixing on hoods**

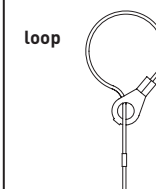

# AH M25IF(L) - AH M32IF(L) cable glands HYGIENIC SERIES

enclosures:  
HYGIENIC T-TYPE / H IP66/IP69  
(only M25 or M32)

page:  
501 - 504

## HYGIENIC M25 cable gland

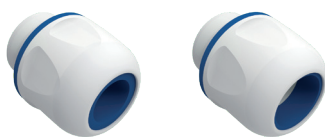

## HYGIENIC M32 cable gland

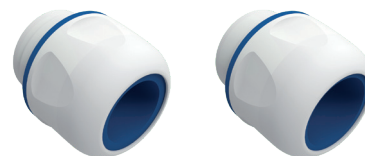

description	part No.	M threading	part No.	M threading
cable glands M25X1,5 for cable $\varnothing$ 12,0-15,0 for cable $\varnothing$ 15,0-18,0	<b>AH M25IF</b> <b>AH M25IFL</b>	M25 M25	<b>AH M32IF</b> <b>AH M32IFL</b>	M32 M32

NOTE: For details about their installation refer to the instruction sheet accompanying the product:

- ECOLAB compliant
- EHEDG compliant
- IP68, IP69 degree of protection
- ambient temperature limit: -20 °C ... +85 °C
- cURus, cULus, EAC certifications

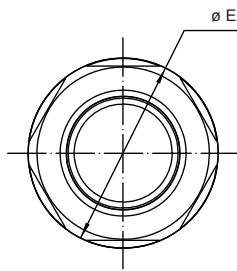
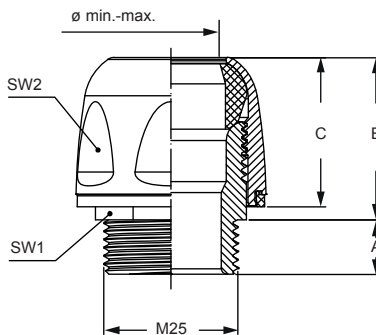
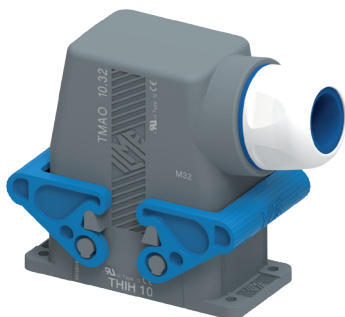

part No.	A	B	C	SW1	SW2	$\varnothing$ E	$\varnothing$ min.-max.
<b>AH M25IF</b>	10	30	27	24	32	34,9	12,0-15,0
<b>AH M25IFL</b>	10	30	27	24	32	34,9	15,0-18,0

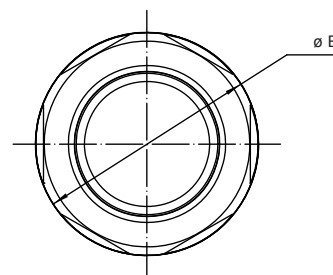
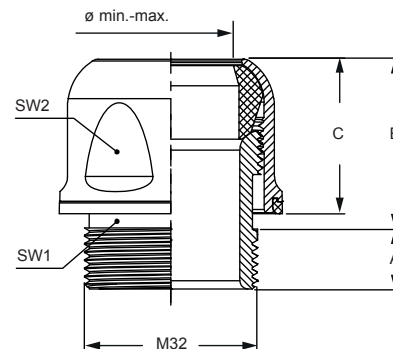

part No.	A	B	C	SW1	SW2	$\varnothing$ E	$\varnothing$ min.-max.
<b>AH M32IF</b>	11	32	28	30	38	40,9	18,0-21,0
<b>AH M32IFL</b>	11	32	28	30	38	40,9	20,0-23,0

T-TYPE / H - CABLE GLANDS

# T-TYPE / C low-temperature HYGIENIC SERIES

inserts		page:
CDD	24 poles + ⊕	76
CDS	9 poles + ⊕	-
CDSH	9 poles + ⊕	86
CDSH NC	6 poles + ⊕	95
CNE	6 poles + ⊕	110
CSE	6 poles + ⊕	-
CSH	6 poles + ⊕	110
CSH S	6 poles + ⊕	122
CCE	6 poles + ⊕	130
CSS	6 poles + ⊕	148
CT, CTSE (16A) *	6 poles + ⊕	160
CQE	10 poles + ⊕	168
MIXO	2 modules	232 - 28

\*) only for standard insulating version THIC

## housings with single lever SILICONE gasket

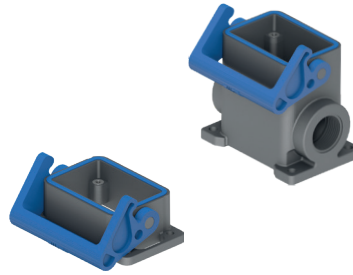

## hoods with single lever, top entry covers SILICONE gasket

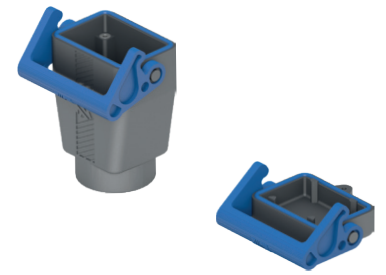

description	part No.	entry M	part No.	part No. (with loop)
bulkhead mounting housing with thermoplastic lever	<b>THIC 06 L</b>			
surface mounting housing, thermoplastic lever, high construction	<b>TAPC 06 L25</b>	25		
surface mounting housing, thermoplastic lever, high construction	<b>TAPC 06 L32</b>	32		
with thermoplastic lever and gasket, high construction			<b>TAVC 06 LG25</b>	25
with thermoplastic lever and gasket, high construction			<b>TAVC 06 LG32</b>	32
cover with thermoplastic lever and gasket				<b>THCC 06 LG</b>

panel cut-out for bulkhead mounting housings

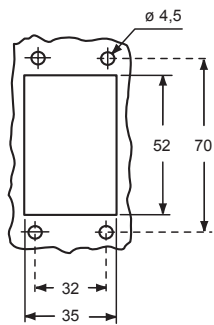

**Hoods  
TMAO  
(page 480)**

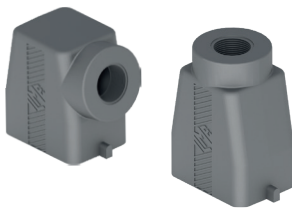

**Hoods  
TMAV  
(page 480)**

**Covers  
with eyelet  
TCHC L  
TCHC SL  
(page 481)**



**CAUS**® Type 12



ambient temperature limits -50 °C / +70 °C

### THIC L

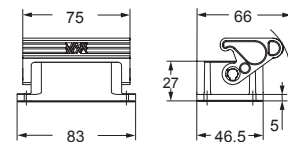

### TAPC L

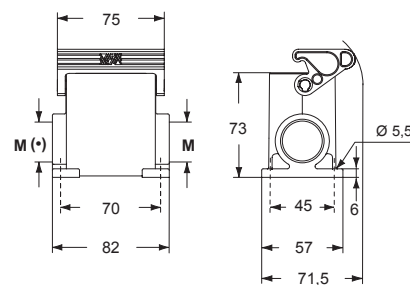

(+) The surface mounting, high construction housings are supplied with an open threaded entry (+) and diametrically opposite a closed threaded entry which can be opened by the user if required (with suitable tool).

### TAVC LG

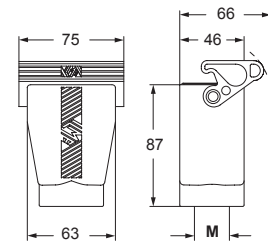

### THCC LG

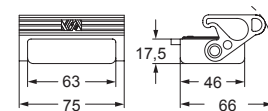

### For fixing on hoods

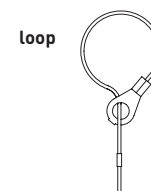



# T-TYPE / C low-temperature HYGIENIC SERIES

inserts		page:
CDD	42 poles + ⊕	78
CDS	18 poles + ⊕	-
CDSH	18 poles + ⊕	87
CNE	10 poles + ⊕	111
CSE	10 poles + ⊕	-
CSH	10 poles + ⊕	111
CSH S	10 poles + ⊕	123
CCE	10 poles + ⊕	131
CMSH	3+2 (aux) poles + ⊕	136
CMCE	3+2 (aux) poles + ⊕	137
CSS	10 poles + ⊕	149
CT, CTSE (16A) *)	10 poles + ⊕	161
CQE	18 poles + ⊕	169
CX	8/24 poles + ⊕	194
MIXO	3 modules	232 - 287

\*) only for standard insulating version THIC

## housings with double lever SILICONE gasket

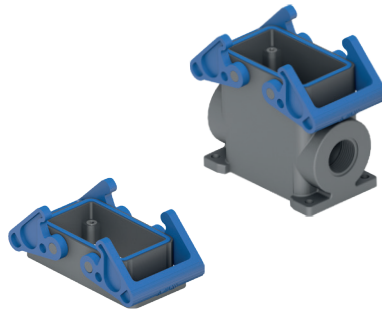

## hoods with double lever, top entry covers SILICONE gasket

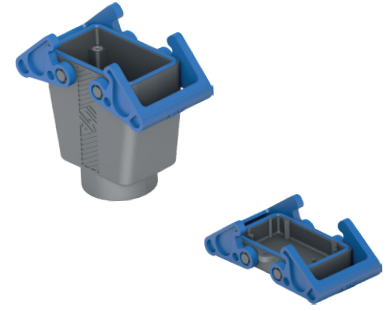

description	part No.	entry M	part No.	part No. (with loop)
bulkhead mounting housing with thermoplastic levers	<b>THIC 10</b>			
surface mounting housing, thermoplastic levers, high construction	<b>TAPC 10.25</b>	25		
surface mounting housing, thermoplastic levers, high construction	<b>TAPC 10.32</b>	32		
with thermoplastic levers and gasket, high construction			<b>TAVC 10 G25</b>	25
with thermoplastic levers and gasket, high construction			<b>TAVC 10 G32</b>	32
with 2 thermoplastic levers and gasket				<b>THCC 10 G</b>

panel cut-out for bulkhead mounting housings

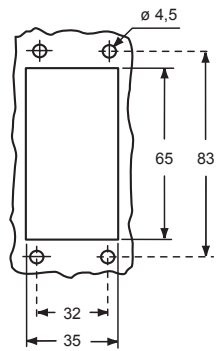

**Hoods  
TMAO  
(page 482)**

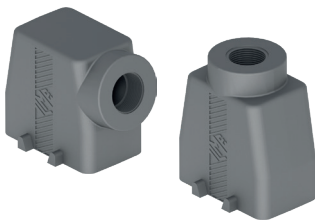

**Hoods  
TMAV  
(page 482)**

**Covers  
with eyelet  
TCHC  
TCHC S  
(page 483)**



**CE** **RU** <sup>®</sup> **US** Type 12

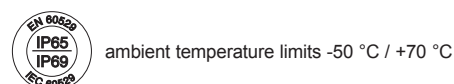

### THIC

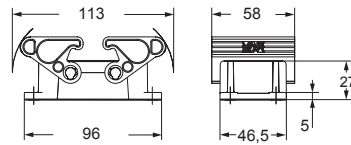

### TAPC

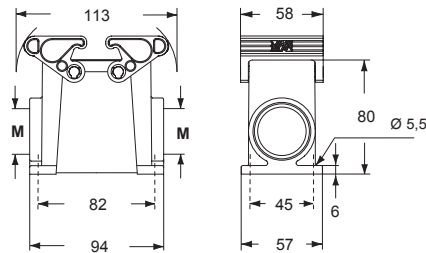

The surface mounting, high construction housings are supplied with an open threaded entry and diametrically opposite a closed threaded entry which can be opened by the user if required (with suitable tool).

### TAVC G

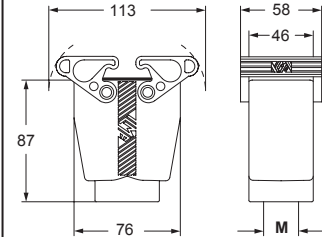

### THCC G

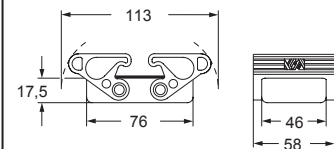

For fixing on hoods

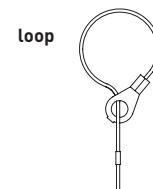

# T-TYPE / C low-temperature HYGIENIC SERIES

inserts		page:
CD	40 poles + ⊕	70
CDD	72 poles + ⊕	79
CDS	27 poles + ⊕	-
CDSH	27 poles + ⊕	88
CNE	16 poles + ⊕	112
CSE	16 poles + ⊕	-
CSH	16 poles + ⊕	112
CSH S	16 poles + ⊕	124
CCE	16 poles + ⊕	132
CMSH, CMCE	6+2 (aux) poles + ⊕	138 - 139
CSS	16 poles + ⊕	150
CT, CTSE (16A) *)	16 poles + ⊕	162
CQE	32 poles + ⊕	170
CQEE	40 poles + ⊕	176
CP	6 poles + ⊕	178
CX	6/12, 6/36 and 12/2 poles + ⊕	197 - 199
CX	4/0 and 4/2 poles + ⊕	200 - 201
MIXO	4 modules	232 - 287

\*) only for standard insulating version THIC

## housings with double lever SILICONE gasket

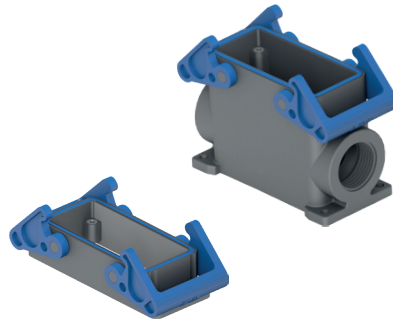

## hoods with double lever, top entry covers SILICONE gasket



description	part No.	entry M	part No.	part No. (with loop)
bulkhead mounting housing with thermoplastic levers	<b>THIC 16</b>			
surface mounting housing, thermoplastic levers, high construction	<b>TAPC 16.32</b>	32		
surface mounting housing, thermoplastic levers, high construction	<b>TAPC 16.40</b>	40		
with thermoplastic levers and gasket, high construction			<b>TAVC 16 G32</b>	32
with thermoplastic levers and gasket, high construction			<b>TAVC 16 G40</b>	40
cover with 2 thermoplastic levers and gasket				<b>THCC 16 G</b>

panel cut-out for bulkhead mounting housings

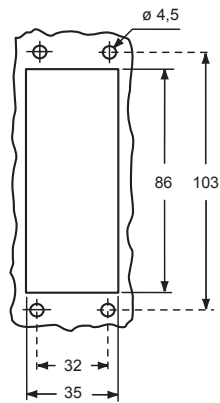

**Hoods  
TMAO  
(page 484)**

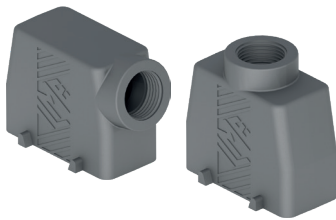

**Hoods  
TMAV  
(page 484)**

**Covers  
with eyelet  
TCHC  
TCHC S  
(page 485)**



**CAUS**® Type 12



ambient temperature limits -50 °C / +70 °C

### THIC

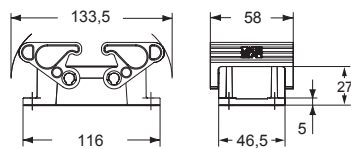

### TAPC

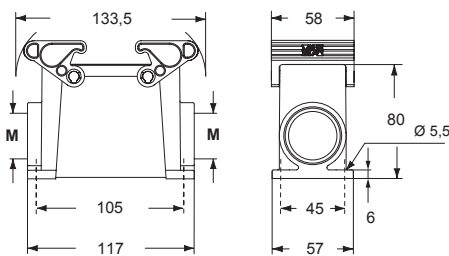

The surface mounting, high construction housings are supplied with an open threaded entry and diametrically opposite a closed threaded entry which can be opened by the user if required (with suitable tool).

### TAVC G

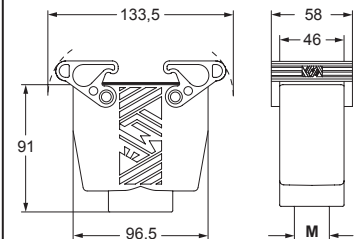

### THCC G

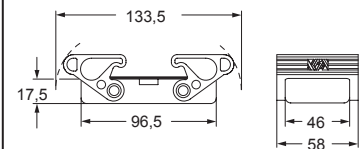

For fixing on hoods

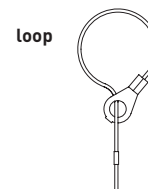

# T-TYPE / C low-temperature HYGIENIC SERIES

inserts		page:
CD	64 poles + ⊕	72
CDD	108 poles + ⊕	81
CDS	42 poles + ⊕	-
CDSH	42 poles + ⊕	89
CNE	24 poles + ⊕	113
CSE	24 poles + ⊕	-
CSH	24 poles + ⊕	113
CSH S	24 poles + ⊕	125
CCE	24 poles + ⊕	133
CMSH	10+2 (aux) poles + ⊕	140
CMCE	10+2 (aux) poles + ⊕	141
CSS	24 poles + ⊕	151
CT, CTSE (16A) *)	24 poles + ⊕	163
CQE	46 poles + ⊕	171
CQEE	64 poles + ⊕	177
CX	4/8 and 6/6 poles + ⊕	204 and 206
MIXO	6 modules	232 - 287

\*) only for standard insulating version THIC

## housings with double lever SILICONE gasket

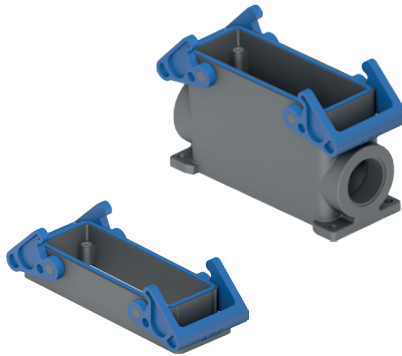

## hoods with double lever, top entry covers SILICONE gasket



description	part No.	entry M	part No.	part No. (with loop)
bulkhead mounting housing with thermoplastic levers	<b>THIC 24</b>			
surface mounting housing, thermoplastic levers, high construction	<b>TAPC 24.32</b>	32		
surface mounting housing, thermoplastic levers, high construction	<b>TAPC 24.40</b>	40		
with thermoplastic levers and gasket, high construction			<b>TAVC 24 G32</b>	32
with thermoplastic levers and gasket, high construction			<b>TAVC 24 G40</b>	40
cover with 2 thermoplastic levers and gasket				<b>THCC 24 G</b>

### panel cut-out for bulkhead mounting housings

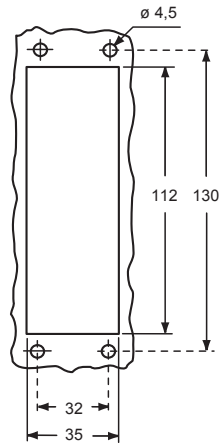

**Hoods  
TMAO  
(page 486)**



**Hoods  
TMAV  
(page 486)**

**Covers  
with eyelet  
TCHC  
TCHC S  
(page 487)**



**CE** **RU** **US** Type 12



ambient temperature limits -50 °C / +70 °C

### THIC

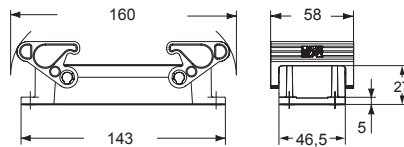

### TAPC

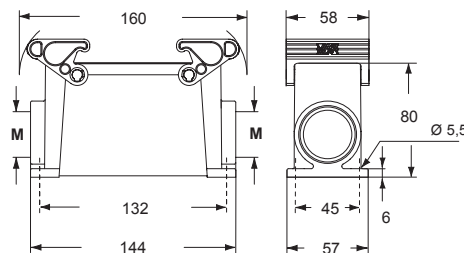

The surface mounting, high construction housings are supplied with an open threaded entry and diametrically opposite a closed threaded entry which can be opened by the user if required (with suitable tool).

### TAVC G

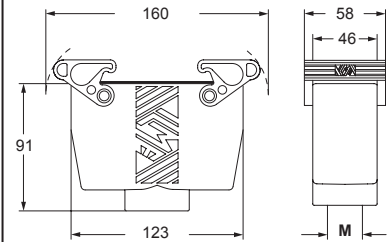

### THCC G

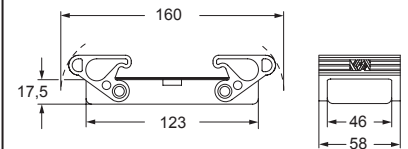

### For fixing on hoods

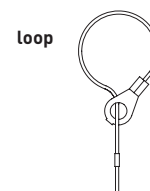

# CR..BPE PE earth jumpers

inserts		page:
CD	40, 64 poles + ⊕	70 and 72
CDD	24, 42, 72, 108 poles + ⊕	76 - 81
CDS	9, 18, 27, 42 poles + ⊕	-
CDSH	9, 18, 27, 42 poles + ⊕	86 - 89
CNE	6, 10, 16, 24 poles + ⊕	110 - 113
CSE	6, 10, 16, 24 poles + ⊕	-
CSH	6, 10, 16, 24 poles + ⊕	110 - 113
CSH S	6, 10, 16, 24 poles + ⊕	122 - 125
CCE	6, 10, 16, 24 poles + ⊕	130 - 133
CMSH	3, 6, 10 +2 (aux) poles + ⊕	136 - 140
CMCE	3, 6, 10 +2 (aux) poles + ⊕	137 - 141
CSS	6, 10, 16, 24 poles + ⊕	148 - 151
CT, CTSE	6, 10, 16, 24 poles + ⊕	160 - 163
CQE	10, 18, 32, 46 poles + ⊕	168 - 171
CQEE	40, 64 poles + ⊕	176 - 177
CP	6 poles + ⊕	178
CX	8/24, 6/36, 12/2 poles + ⊕	194 - 199

## PE optional earth jumpers

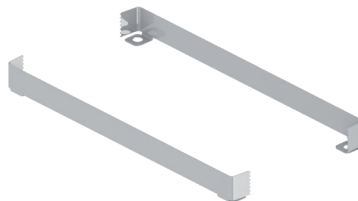

description

part No.

galvanized brass, to be optionally used with T-TYPE enclosures series:  
 for inserts "44.27" size  
 for inserts "57.27" size  
 for inserts "77.27" size  
 for inserts "104.27" size

**CR 06 BPE**  
**CR 10 BPE**  
**CR 16 BPE**  
**CR 24 BPE**

CR...BPE accessories PE (protective earth) jumpers could be mounted under the connector inserts for the connection of the two insert's PE plates.

To guarantee to proper alignment of the insert inside the enclosure, it is necessary to use both jumpers supplied (in the same housing or hood); the jumpers are not usable individually.

Furthermore the user is responsible for verifying the continuity of the PE connection ⊕ (male and female) independently of using CR...BPE earth jumpers.

Optional earth jumpers

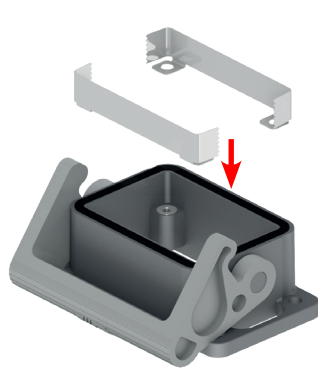

T-TYPE - ACCESSORIES

## W-TYPE

### ENCLOSURES for aggressive environments

#### A cornerstore against corrosion

Series W-TYPE connector enclosures for aggressive environments is specially **designed for industrial applications where particularly aggressive external agents are present** (e.g. salty environments, etc.)

The range includes enclosures in the 7 basic sizes (size 21.21 for CKA..W and MKA..W models, sizes 44.27, 57.27, 77.27 and 104.27 for CH..W, CA..W and MH..W, MA..W models, sizes 49.16 and 66.16 for CZ..W and MZ..W models) and in the 3 double sizes (sizes 66.40 also known as 50 poles, 77.62 a.k.a. 32 poles, 104.62 a.k.a. 48 poles).

Series W-TYPE enclosures may be bulkhead mounting, surface-mounting or hood type with side or top entry. They are **distinguished by the black colour** and have the following characteristics:

- **chromate conversion treatment of castings** RoHS 2 compliant, providing **50% improved corrosion in resistance in salt spray tests** (according to UNI EN ISO 9227) compared to the previous green coloured versions;
- **thermosetting epoxy powder coating** (with improved resistance to chemicals compared to epoxy polyester of the standard enclosures series);
- **FKM fluoroelastomer gaskets** (with improved resistance to chemicals and aging);
- **ambient temperature limits from -40 °C to +125 °C.**

Other constructional characteristics are:

#### 1) CKA..W and MKA..W series

- 21.21 inserts size
- stainless steel monoblock locking lever

#### 2) CH..W, CA..W and MH..W, MA..W series

- 44.27, 57.27, 77.27, 104.27, single inserts sizes and 77.62, 104.62, 66.40 double inserts sizes;
- CLASS type locking levers (stainless steel lever body, springs and pins, lever handle by fibreglass reinforced thermoplastic material);
- stainless steel riveted pegs;
- supplementary insulation inside enclosures.

#### 3) CZ..W and MZ..W series

- 49.16, 66.16 inserts size;
- stainless steel monoblock locking lever (body, handle, springs), rolls and pins;
- stainless steel riveted pegs;
- supplementary insulation inside enclosures.

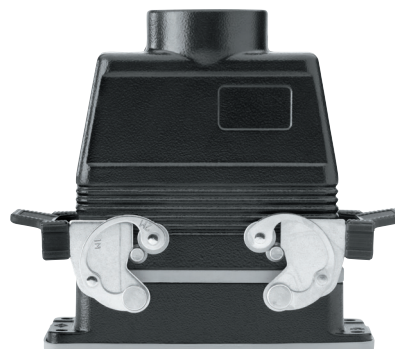

Series W-TYPE enclosures are approved by UL with **cULus** Recognized Component mark for USA and Canada, with protection type ratings **UL Type 4 (= NEMA 4)**, **UL Type 4X (= NEMA 4X)** and **UL Type 12 (= NEMA 12)** according to the American standard ANSI/UL 50 and ANSI/UL 50E and the corresponding Canadian Standards CSA C22.2 No.94.1 and CSA C22.2 No.94.2.

Upon connector complete and fitted with suitably rated cable glands or conduit fittings, series W-TYPE enclosures guarantee a **degree of protection IP44** (for size 21.21, **IP66/IP67** using CKR 65(D) kit), or **IP66** (all other sizes) as well as **IP69** according to EN 60529 (the IPX9 test recently added to this standard covers resistance to high pressure and temperature water jetting, jets applied at 80 °C (± 5 °C) at a pressure of 80 bar to 100 bar, 30 s for each angle of inclination 0°, 30°, 60° and 90° with reference to the horizontal plane).

Series W-TYPE enclosures **can accommodate all connector inserts** with either crimp, screw, spring or the innovative **SQUICH®** connection.

Series W-TYPE enclosures, being not equipped with internal tabs and thanks to the additional insulation strips placed inside, are **also suitable for series CME 830V rated inserts.**

# CKA - MKA W-TYPE for aggressive environments

inserts		page:
CK	3 poles + ⊕	58
CK	4 poles + ⊕	58
CKS	3 poles + ⊕	-
CKS	4 poles + ⊕	-
CKSH	3 poles + ⊕	63
CKSH	4 poles + ⊕	63
CD	8 poles	67
CQ4	2 poles + ⊕	182
CQ4 H	2 poles + ⊕	183
CQ4	3 poles + ⊕	184
CQ	5 poles + ⊕	186
CQ	7 poles + ⊕	187
CQ	12 poles + ⊕	189
CQ	21 poles + ⊕	190

## bulkhead mounting housings straight and angled

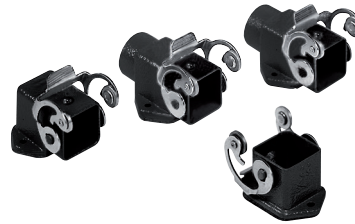

## hoods



description	part No. (entry - Pg11)	part No. (entry - M20)	part No. (entry - Pg11)	part No. (entry - M20 / M25)
with stainless steel lever and gasket	<b>CKAXW 03 I</b>			
without cable entry, with stainless steel lever and gasket	<b>CKAXW 03 IA</b>			
with cable entry, with stainless steel lever and gasket	<b>CKAXW 03 IAP</b>	<b>MKAXW IAP20</b>		
with cable entry, with stainless steel lever and gasket, bulkhead hole closed	<b>CKAXW 03 AP</b>	<b>MKAXW AP20</b>		
with pegs, top entry			<b>CKAW 03 V</b>	<b>MKAW V20</b>
with pegs, top entry			<b>CKAW 03 VA</b>	<b>MKAW V25</b>
with pegs, side entry			<b>CKAXW 03 VG</b>	<b>MKAXW VG20</b>
with stainless steel lever, top entry			<b>CKR 65</b>	<b>CKR 65 D</b>
gasket and screw kit for IP66/IP67/IP69 1)	<b>CKR 65</b>		<b>CKR 65</b>	
for CK, CKSH, CQ4, CQ inserts				
gasket and screw kit for IP66/IP67/IP69 1)	<b>CKR 65 D</b>		<b>CKR 65 D</b>	
for CD 08 inserts				

1) To obtain the IP66/IP67/IP69 degree of protection, a kit with insert fixing screw and gasket can be purchased separately.  
Several inserts size "21.21" are already supplied with fixing screw and gasket, which ensures IP66/IP67/IP69 degree of protection. See list below, not including any special version:

- CQF/M 07, CQF/M 12
- CJ KF/M, CJF/M 4 /4/2 /8 /8/2
- CJK 8FT /8IFT /8MT /8IMT, CJK 8M
- CUK 2FT /3FT
- CX 1/2 BDF/M
- CLK 04 SCF /SCF-H /SCM
- CXL 2/4 PF /PM /PFH /PMH /SF /SM, CXL SF/M.

NOTE: Housing type and colour may vary upon specific part No.

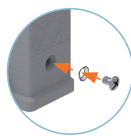

panel cut-out for bulkhead mounting housings

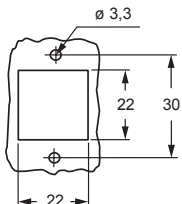

### CKAXW I

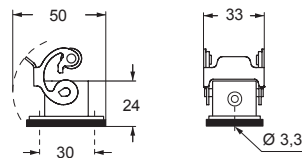

### CKAXW IA

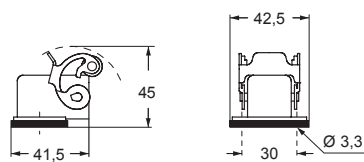

### CKAXW IAP (CKAXW AP) and MKAXW IAP (MKAXW AP)

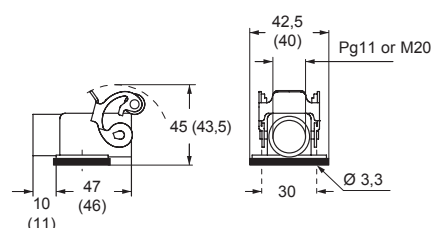

### CKAW V and MKAW V20 - V25

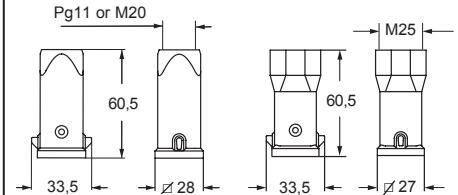

### CKAW VA and MKAW VA

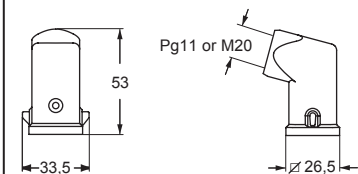

### CKAXW VG and MKAXW VG

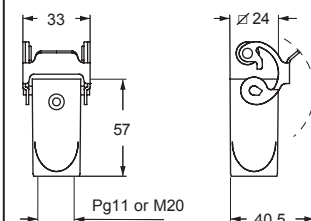

**CAUS** Type 12  
Type 4/4X only  
with CKR 65 (D)



IP66/IP67/IP69 with CKR 65 (D) 1)

W-TYPE



# CKAX - CKAXX W-TYPE for aggressive environments

inserts		page:
CK	3 poles + ⊕	58
CK	4 poles + ⊕	58
CKS	3 poles + ⊕	-
CKS	4 poles + ⊕	-
CKSH	3 poles + ⊕	63
CKSH	4 poles + ⊕	63
CD	8 poles	67
CQ4	2 poles + ⊕	182
CQ4 H	2 poles + ⊕	183
CQ4	3 poles + ⊕	184
CQ	5 poles + ⊕	186
CQ	7 poles + ⊕	187
CQ	12 poles + ⊕	189
CQ	21 poles + ⊕	190

## angled bulkhead mounting housings stainless steel lever



## angled bulkhead mounting housings stainless steel rigid lever



description	part No.	part No.
without cable entry, fixing by 4 screws	<b>CKAXW 03 IA4</b>	<b>CKAXXW 03IA4</b>
gasket and screw kit for IP66/IP67/IP69 <sup>1)</sup> for CK, CKSH, CQ4, CQ inserts	<b>CKR 65</b>	<b>CKR 65</b>
gasket and screw kit for IP66/IP67/IP69 <sup>1)</sup> for CD 08 inserts	<b>CKR 65 D</b>	<b>CKR 65 D</b>

<sup>1)</sup> To obtain the IP66/IP67/IP69 degree of protection, a kit with insert fixing screw and gasket can be purchased separately.  
 Several inserts size "21.21" are already supplied with fixing screw and gasket, which ensures IP66/IP67/IP69 degree of protection. See list below, not including any special version:

- CQF/M 07, CQF/M 12
- CJ KF/M, CJF/M 4 /4/2 /8 /8/2
- CJK 8FT /8IFT /8MT /8IMT, CJK 8M
- CUK 2FT /3FT
- CX 1/2 BDF/M
- CLK 04 SCF /SCF-H /SCM
- CXL 2/4 PF /PM /PFH /PMH /SF /SM, CXL SF/M

NOTE: Housing type and colour may vary upon specific part No.

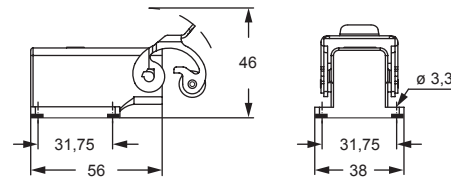
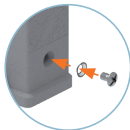

panel cut-out for enclosures

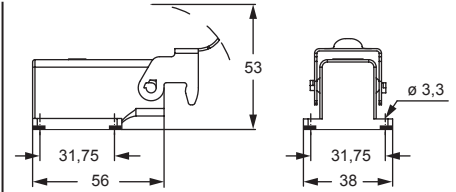
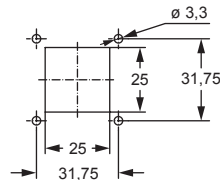

panel cut-out for enclosures

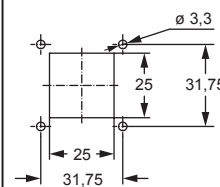

IP66/IP67/IP69 with CKR 65 (D) <sup>1)</sup>

# MKAX W-TYPE for aggressive environments

inserts		page:
CK	3 poles + ⊕	58
CK	4 poles + ⊕	58
CKS	3 poles + ⊕	-
CKS	4 poles + ⊕	-
CKSH	3 poles + ⊕	63
CKSH	4 poles + ⊕	63
CD	8 poles	67
CQ4	2 poles + ⊕	182
CQ4 H	2 poles + ⊕	183
CQ4	3 poles + ⊕	184
CQ	5 poles + ⊕	186
CQ	7 poles + ⊕	187
CQ	12 poles + ⊕	189
CQ	21 poles + ⊕	190

## angled surface mounting housings stainless steel lever



## angled surface mounting housings stainless steel lever



description	part No. (entry - M25)	part No. (entry - M25)
with cable entry, fixing by 4 screws	<b>MKAXW IAP25</b>	
with cable entry, fixing by 4 screws, bulkhead hole closed (without gasket)		<b>MKAXW AP25</b>
gasket and screw kit for IP66/IP67/IP69 1) for CK, CKSH, CQ4, CQ, inserts	<b>CKR 65</b>	<b>CKR 65</b>
gasket and screw kit for IP66/IP67/IP69 1) for CD 08 inserts	<b>CKR 65 D</b>	<b>CKR 65 D</b>

1) To obtain the IP66/IP67/IP69 degree of protection, a kit with insert fixing screw and gasket can be purchased separately.  
 Several inserts size "21.21" are already supplied with fixing screw and gasket, which ensures IP66/IP67/IP69 degree of protection. See list below, not including any special version:  
 - CQF/M 07, CQF/M 12  
 - CJ KF/M, CJF/M 4 /4/2 /8 /8/2  
 - CJK 8FT /8IFT /8MT /8IMT, CJK 8M  
 - CUK 2FT /3FT  
 - CX 1/2 BDF/M  
 - CLK 04 SCF /SCF-H /SCM  
 - CXL 2/4 PF /PM /PFH /PMH /SF /SM, CXL SF/M

NOTE: Housing type and colour may vary upon specific part No.

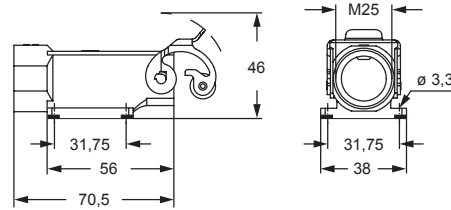
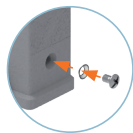

panel cut-out for enclosures

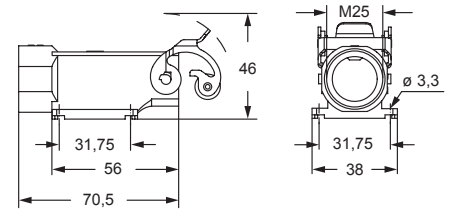
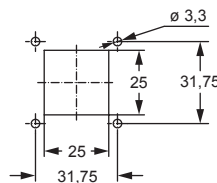

panel cut-out for enclosures

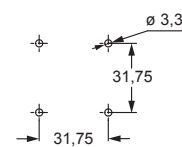

IP66/IP67/IP69 with CKR 65 (D) 1)

# MKAXX W-TYPE for aggressive environments

inserts		page:
CK	3 poles + ⊕	58
CK	4 poles + ⊕	58
CKS	3 poles + ⊕	-
CKS	4 poles + ⊕	-
CKSH	3 poles + ⊕	63
CKSH	4 poles + ⊕	63
CD	8 poles	67
CQ4	2 poles + ⊕	182
CQ4 H	2 poles + ⊕	183
CQ4	3 poles + ⊕	184
CQ	5 poles + ⊕	186
CQ	7 poles + ⊕	187
CQ	12 poles + ⊕	189
CQ	21 poles + ⊕	190

## angled surface mounting housings stainless steel rigid lever



## angled surface mounting housings stainless steel rigid lever



description	part No. (entry - M25)	part No. (entry - M25)
with cable entry, fixing by 4 screws	<b>MKAXXW IAP25</b>	
with cable entry, fixing by 4 screws, bulkhead hole closed (without gasket)		<b>MKAXXW AP25</b>
gasket and screw kit for IP66/IP67 <sup>1)</sup> for CK, CKSH, CQ4, CQ, inserts	<b>CKR 65</b>	<b>CKR 65</b>
gasket and screw kit for IP66/IP67 <sup>1)</sup> for CD 08 inserts	<b>CKR 65 D</b>	<b>CKR 65 D</b>

<sup>1)</sup> To obtain the IP66/IP67/IP69 degree of protection, a kit with insert fixing screw and gasket can be purchased separately.  
Several inserts size "21.21" are already supplied with fixing screw and gasket, which ensures IP66/IP67/IP69 degree of protection. See list below, not including any special version:

- CQF/M 07, CQF/M 12
- CJ KF/M, CJF/M 4 /4/2 /8 /8/2
- CJK 8FT /8IFT /8MT /8IMT, CJK 8M
- CUK 2FT /3FT
- CX 1/2 BDF/M
- CLK 04 SCF /SCF-H /SCM
- CXL 2/4 PF /PM /PFH /PMH /SF /SM, CXL SF/M

NOTE: Housing type and colour may vary upon specific part No.

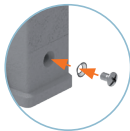

### MKA IAP

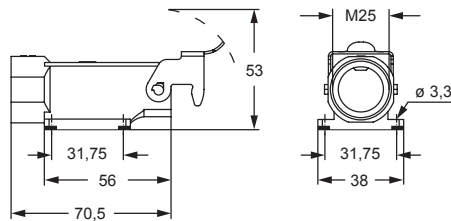

### panel cut-out for enclosures

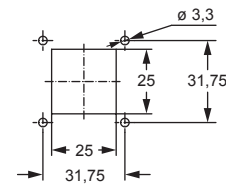

### MKAXX IAP

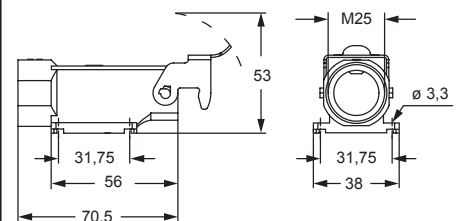

### panel cut-out for enclosures

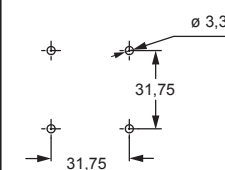

IP66/IP67/IP69 with CKR 65 (D) <sup>1)</sup>

# MKAX W-TYPE for aggressive environments

inserts		page:
CK	3 and 4 poles + ⊕	58
CKS	3 and 4 poles + ⊕	-
CKSH	3 and 4 poles + ⊕	63
CD	8 poles	67
CQ4	2 poles + ⊕	182
CQ4 H	2 poles + ⊕	183
CQ4	3 poles + ⊕	184
CQ	5 poles + ⊕	186
CQ	7 poles + ⊕	187
CQ	12 poles + ⊕	189
CQ	21 poles + ⊕	190
CJ KF		305
CJK 8FT		308
CLK 04 SC		321
CX 1/2 BD		325
CXL 2/4 SF/SM		332
CXL SF/SM		332
CXL 2/4 PF/PM		333
CXL 2/4 PFH/PMH		333
CXL PF/PM		333

## bulkhead mounting housings stainless steel lever



AVAILABLE MAY 2019

description	part No. (entry - M32)
M32 fixing thread <sup>(*) 1)</sup>	<b>MKAXW IF</b>
gasket and screw kit for IP66/IP67/IP69 <sup>1)</sup>	<b>CKR 65</b>
gasket and screw kit for IP66/IP67/IP69 <sup>1)</sup> specific for CD 08 inserts	<b>CKR 65 D</b>

1) To obtain the IP66/IP67/IP69 degree of protection, a kit with insert fixing screw and gasket can be purchased separately. Several inserts size "21.21" are already supplied with fixing screw and gasket, which ensures IP66/IP67/IP69 degree of protection. See list below, not including any special version:

- CQF/M 07, CQF/M 12
- CJ KF/M, CJF/M 4 / 4/2 / 8 / 8/2
- CJK 8FT / 8IFT / 8MT / 8IMT, CJK 8M
- CUK 2FT / 3FT
- CX 1/2 BDF/M
- CLK 04 SCF / SCF-H / SCM
- CXL 2/4 PF / PM / PFH / PMH / SF / SM, CXL SF/M.

NOTE: Housing type and colour may vary upon specific part No.

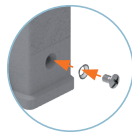

<sup>(\*)</sup> Locknut supplied on request, see Cable glands catalogue (article AS M32N metallic).

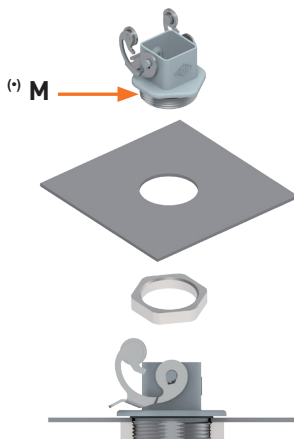

NOTE: Lever type and housing colour may vary upon specific part No.

cURus  
Type 4/4X/12 pending



IP44 IP66/IP67/IP69 with CKR 65 (D) <sup>1)</sup>

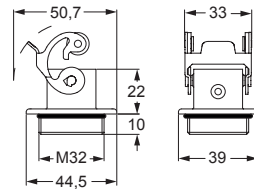

panel cut-out for enclosures

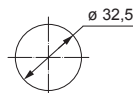

# MKAXX W-TYPE for aggressive environments

inserts		page:
CK	3 and 4 poles + ⊕	58
CKS	3 and 4 poles + ⊕	-
CKSH	3 and 4 poles + ⊕	63
CD	8 poles	67
CQ4	2 poles + ⊕	182
CQ4 H	2 poles + ⊕	183
CQ4	3 poles + ⊕	184
CQ	5 poles + ⊕	186
CQ	7 poles + ⊕	187
CQ	12 poles + ⊕	189
CQ	21 poles + ⊕	190
CJ KF		305
CJK 8FT		308
CLK 04 SC		321
CX 1/2 BD		325
CXL 2/4 SF/SM		332
CXL SF/SM		332
CXL 2/4 PF/PM		333
CXL 2/4 PFH/PMH		333
CXL PF/PM		333

## bulkhead mounting housings stainless steel rigid lever



AVAILABLE MAY 2019

description	part No. (entry - M32)
M32 fixing thread <sup>(*)</sup> 1)	<b>MKAXXW IF</b>
gasket and screw kit for IP66/IP67/IP69 <sup>1)</sup>	<b>CKR 65</b>
gasket and screw kit for IP66/IP67/IP69 <sup>1)</sup> specific for CD 08 inserts	<b>CKR 65 D</b>

1) To obtain the IP66/IP67/IP69 degree of protection, a kit with insert fixing screw and gasket can be purchased separately.  
Several inserts size "21.21" are already supplied with fixing screw and gasket, which ensures IP66/IP67/IP69 degree of protection. See list below, not including any special version:

- CQF/M 07, CQF/M 12
- CJ KF/M, CJF/M 4 /4/2 /8 /8/2
- CJK 8FT /8IFT /8MT /8IMT, CJK 8M
- CUK 2FT /3FT
- CX 1/2 BDF/M
- CLK 04 SCF /SCF-H /SCM
- CXL 2/4 PF /PM /PFH /PMH /SF /SM, CXL SF/M.

NOTE: Housing type and colour may vary upon specific part No.

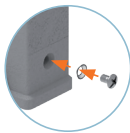

<sup>(\*)</sup> Locknut supplied on request, see Cable glands catalogue (article AS M32N metallic).

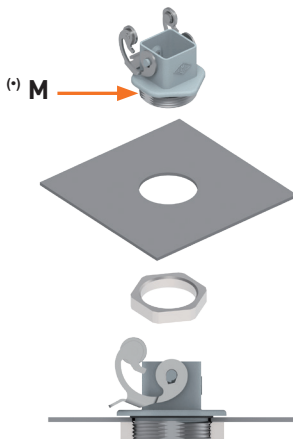

NOTE: Lever type and housing colour may vary upon specific part No.

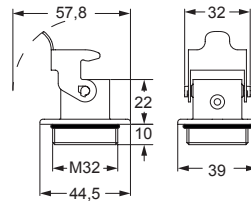

panel cut-out for enclosures

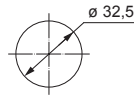

cURus  
Type 4/4X/12 pending



IP66/IP67/IP69 with CKR 65 (D) <sup>1)</sup>

# MKAX - MKAXX W-TYPE for aggressive environments

inserts	page:
CK	3 and 4 poles + ⊕ 58
CKS	3 and 4 poles + ⊕ -
CKSH	3 and 4 poles + ⊕ 63
CD	8 poles 67
CQ4	2 poles + ⊕ 182
CQ4 H	2 poles + ⊕ 183
CQ4	3 poles + ⊕ 184
CQ	5 poles + ⊕ 186
CQ	7 poles + ⊕ 187
CQ	12 poles + ⊕ 189
CQ	21 poles + ⊕ 190
CJ KM	305
CJK 8MT	308
CJK 8IMT	308
CLK 04 SC	321
CX 1/2 BD	325
CXL 2/4 SF/SM	332
CXL SF/SM	332
CXL 2/4 PF/PM	333
CXL 2/4 PFH/PMH	333
CXL PF/PM	333



description	part No. (entry - M25)	part No. (entry - M25)
top entry	<b>MKAXW VG25</b>	<b>MKAXXW VG25</b>
gasket and screw kit for IP66/IP67/IP69 1)	<b>CKR 65</b>	<b>CKR 65</b>
gasket and screw kit for IP66/IP67/IP69 1) specific for CD 08 inserts	<b>CKR 65 D</b>	<b>CKR 65 D</b>

1) To obtain the IP66/IP67/IP69 degree of protection, a kit with insert fixing screw and gasket can be purchased separately. Several inserts size "21.21" are already supplied with fixing screw and gasket, which ensures IP66/IP67/IP69 degree of protection. See list below, not including any special version:

- CQF/M 07, CQF/M 12
- CJ KF/M, CJF/M 4 /4/2 /8 /8/2
- CJK 8FT /8IFT /8MT /8IMT, CJK 8M
- CUK 2FT /3FT
- CX 1/2 BDF/M
- CLK 04 SCF /SCF-H /SCM
- CXL 2/4 PF /PM /PFH /PMH /SF /SM, CXL SF/M

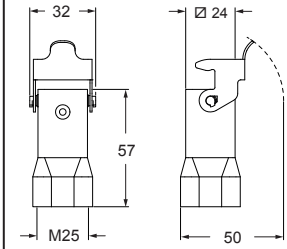
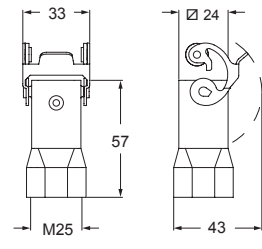

NOTE: Housing type and colour may vary upon specific part No.

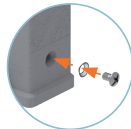

cURus  
Type 12 / Type 4/4X only with CKR 65 (D)  
pending



IP44 IP66/IP67/IP69 with CKR 65 (D) 1)

W-TYPE



# CZ - MZ and CZA - MZA W-TYPE for aggressive environments

inserts		page:
CD	15 poles + ⊕	68
CDA	10 poles + ⊕	98
CSAH	10 poles + ⊕	99
CDC	10 poles + ⊕	104
MIXO	1 module	234 - 286

The covers for L and LG versions cannot be used together with coding pins. If this application is required, please contact ILME SpA.

## housings and cover



## hoods and cover

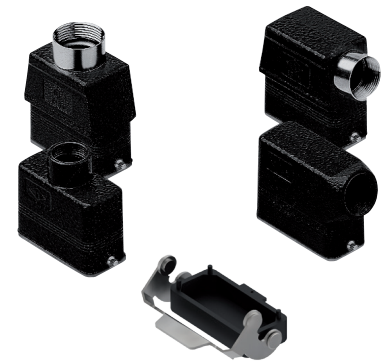

description	part No.	entry Pg	part No.	entry M	part No.	entry Pg	part No.	entry M
bulkhead mounting housing with lever and gasket	<b>CZ7IW 15 L</b>	-						
surface mounting housing, with lever	<b>CZ7PW 15 L2</b>	16 x 2	<b>MZ7PW 15L225</b>	25 x 2				
cover with pegs and gasket (for 1 lever enclosures) 1)	<b>CZCW 15 L</b>							
enclosure with pegs and gasket, side entry					<b>CZOW 15 L</b>	16	<b>MZOW 15 L20</b>	20
enclosure with pegs and gasket, side entry							<b>MZOW 15 L25</b>	25
enclosure with pegs and gasket, side entry, high construction					<b>CZAOW 15 L21</b>	21	<b>MZAOW 15 L25</b>	25
enclosure with pegs and gasket, top entry					<b>CZVW 15 L</b>	13,5	<b>MZVW 15 L20</b>	20
enclosure with pegs and gasket, top entry, high construction					<b>CZAVW 15 L21</b>	21	<b>MZAVW 15 L25</b>	25
cover with lever (for enclosures with pegs) 2)					<b>CZ7CW 15 LG</b>			

panel cut-out for bulkhead mounting housings

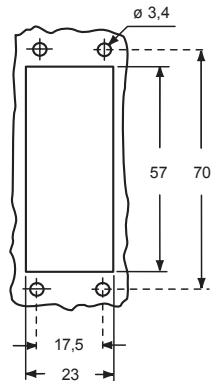

For fixing on housings

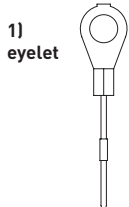

For fixing on hoods

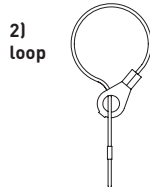

### CZ7IW L

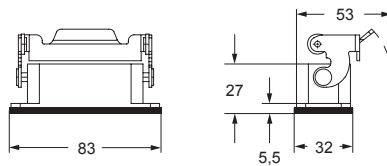

### CZ7PW L and MZ7PW L

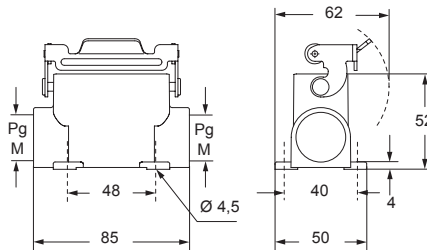

### CZCW L

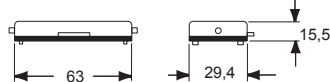

### CZOW L and MZOW L

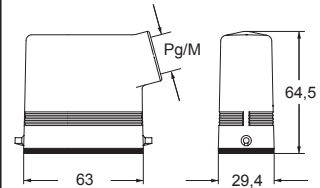

### CZAOW L - MZAOW L and CZAVW L - MZAVW L

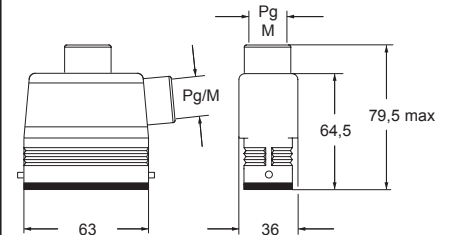

### CZVW L and MZVW L

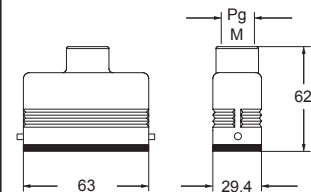

### CZ7CW LG

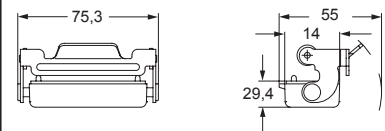

**CAIUS**® Type 4/4X/12



# CZ - MZ and CZA - MZA W-TYPE for aggressive environments

**inserts**

CD	25 poles + ⊕
CDD	38 poles + ⊕
CDA	16 poles + ⊕
CSAH	16 poles + ⊕
CDC	16 poles + ⊕

**page:**

69
77
100
101
105

**housings and cover**



**hoods and cover**

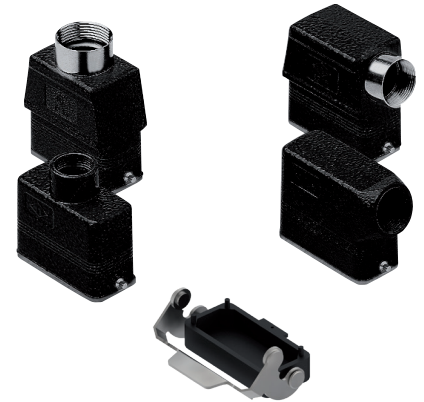

The covers for L and LG versions cannot be used together with coding pins. If this application is required, please contact ILME SpA.

description	part No.	entry Pg	part No	entry M	part No.	entry Pg	part No.	entry M
bulkhead mounting housing with lever and gasket	<b>CZ7IW 25 L</b>	--						
surface mounting housing, with lever	<b>CZ7PW 25 L2</b>	16 x 2	<b>MZ7PW 25L225</b>	25 x 2				
cover with pegs (for 1 lever enclosures) 1)	<b>CZCW 25 L</b>							
enclosure with pegs and gasket, side entry					<b>CZOW 25 L</b>	16	<b>MZOW 25 L20</b>	20
enclosure with pegs and gasket, side entry							<b>MZOW 25 L25</b>	25
enclosure with pegs and gasket, side entry, high construction					<b>CZAOW 25 L21</b>	21	<b>MZAOW 25 L25</b>	25
enclosure with pegs and gasket, top entry					<b>CZVW 25 L</b>	16	<b>MZVW 25 L20 *</b>	20
enclosure with pegs and gasket, top entry, high construction					<b>CZAVW 25 L21</b>	21	<b>MZAVW 25 L25</b>	25
cover with lever (for enclosures with pegs) 2)					<b>CZ7CW 25 LG</b>			

panel cut-out for bulkhead mounting housings

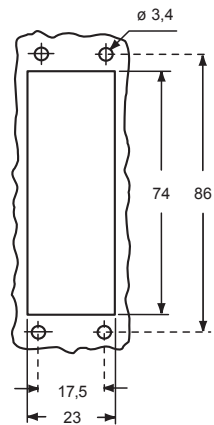

**For fixing on housings**

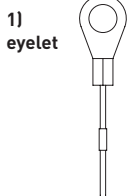

**For fixing on hoods**

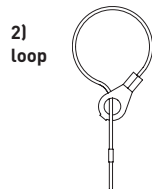

**CZ7IW L**

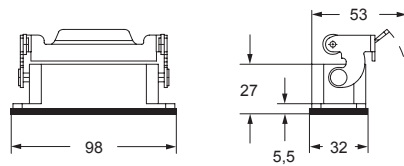

**CZ7PW L and MZ7PW L**

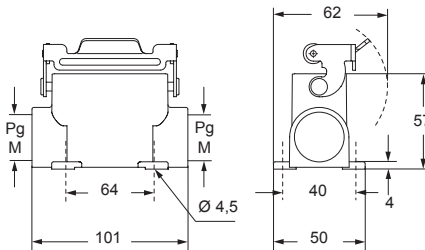

**CZCW L**

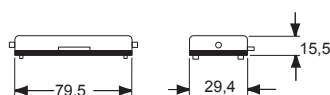

**CZOW L and MZOW L**

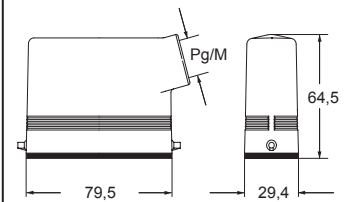

**CZAOW L - MZAOW L and CZAVW L - MZAVW L**

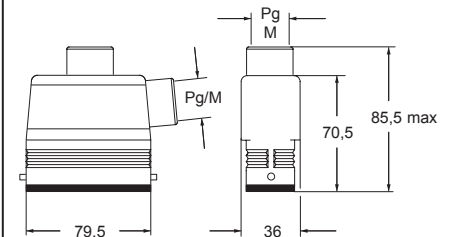

**CZVW L and MZVW L \***

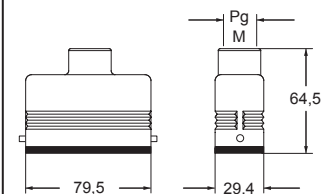

\* can only be used with a complete cable gland (to be purchased separately)

**CZ7CW LG**

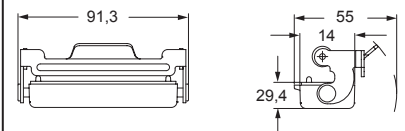

**ILME** Type 4/4X/12



# CH - CA and MA W-TYPE for aggressive environments

inserts		page:
CDD	24 poles + ⊕	76
CDS	9 poles + ⊕	-
CDSH	9 poles + ⊕	86
CDSH NC	6 poles + ⊕	95
CNE	6 poles + ⊕	110
CSE	6 poles + ⊕	-
CSH	6 poles + ⊕	110
CSH S	6 poles + ⊕	122
CCE	6 poles + ⊕	130
CSS	6 poles + ⊕	148
CT, CTSE (16A) *)	6 poles + ⊕	160
CQE	10 poles + ⊕	168
MIXO	2 modules	232 - 287

\*) only for enclosure CHIW 06 L

## housings and cover



## hoods and cover



description	part No.	entry Pg	part No.	entry M	part No.	entry Pg	part No.	entry M
bulkhead mounting housing with lever and gasket	<b>CHIW 06 L</b>	--						
surface mounting housing, with lever, high construction	<b>CAPW 06 L</b>	21	<b>MAPW 06 L32</b>	32				
cover with pegs (for 1 lever enclosures) 1)	<b>CHCW 06 L</b>							
enclosure with pegs, side entry, high construction					<b>CAOW 06 L21</b>	21	<b>MAOW 06 L32</b>	32
enclosure with pegs, top entry, high construction					<b>CAVW 06 L21</b>	21	<b>MAVW 06 L32</b>	32
cover with lever (for enclosures with pegs) 2)					<b>CHCW 06 LG</b>			
enclosure with lever and gasket, side entry, high construction					<b>CAVW 06 LG</b>	21	<b>MAVW 06 LG32</b>	32

panel cut-out for bulkhead mounting housings

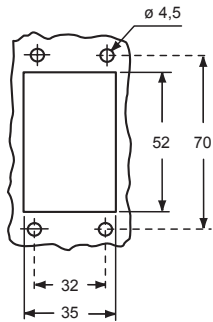

For fixing on housings

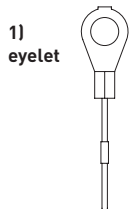

For fixing on hoods

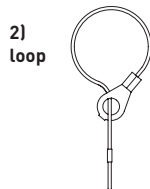

**CAIUS** Type 4/4X/12



### CHIW L

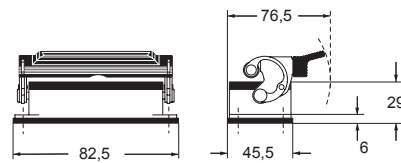

### CAPW L and MAPW L

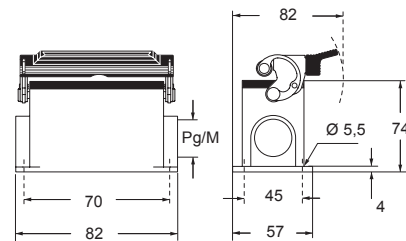

### CHCW L

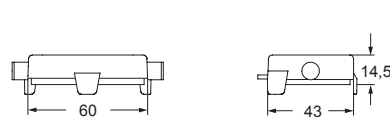

### CAOW L and MAOW L

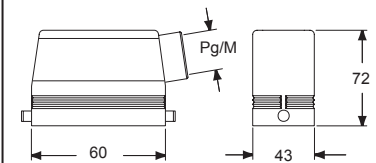

### CAVW L and MAVW L

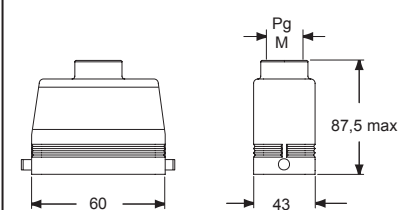

### CHCW LG

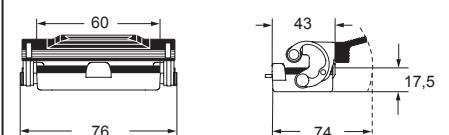

### CAVW LG and MAVW LG

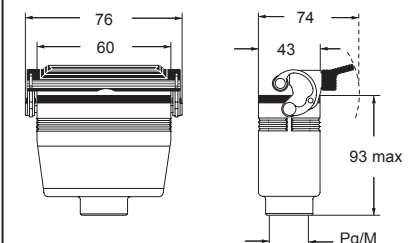

# CH - CA and MA W-TYPE for aggressive environments

inserts		page:
CDD	42 poles + ⊕	78
CDS	18 poles + ⊕	-
CDSH	18 poles + ⊕	87
CNE	10 poles + ⊕	111
CSE	10 poles + ⊕	-
CSH	10 poles + ⊕	111
CSH S	10 poles + ⊕	123
CCE	10 poles + ⊕	131
CMSH	3+2 (aux) poles + ⊕	136
CMCE	3+2 (aux) poles + ⊕	137
CSS	10 poles + ⊕	149
CT, CTSE (16A) *)	10 poles + ⊕	161
CQE	18 poles + ⊕	169
CX	8/24 poles + ⊕	194
MIXO	3 modules	232 - 287

\*) only for enclosure CHIW 10

## housings and cover

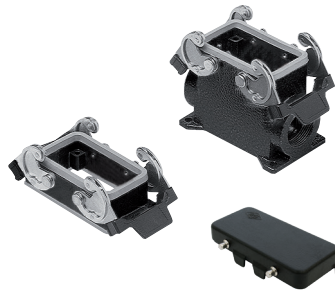

## hoods and cover



description	part No.	entry Pg	part No	entry M	part No.	entry Pg	part No.	entry M
bulkhead mounting housing with levers and gasket	<b>CHIW 10</b>	--						
surface mounting housing, with levers, high construction	<b>CAPW 10.21</b>	21	<b>MAPW 10.32</b>	32				
cover with 4 pegs (for enclosures with 2 levers) 1)	<b>CHCW 10</b>							
enclosure with pegs, side entry, high construction					<b>CAOW 10.21</b>	21	<b>MAOW 10.32</b>	32
enclosure with pegs, top entry, high construction					<b>CAVW 10.21</b>	21	<b>MAVW 10.32</b>	32
cover with 2 levers (for enclosures with 4 pegs) 2)					<b>CHCW 10 G</b>			
enclosure with levers and gasket, top entry, high construction					<b>CAVW 10 G</b>	21	<b>MAVW 10 G32</b>	32

panel cut-out for bulkhead mounting housings

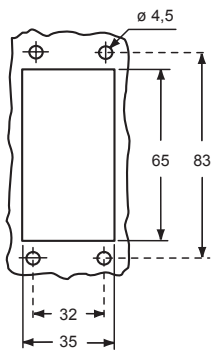

### CHIW

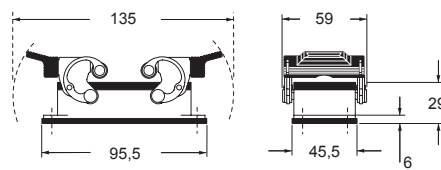

### CAPW and MAPW

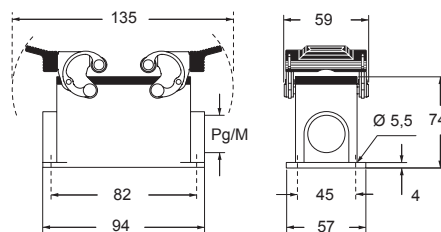

### CHCW



### CAOW and MAOW

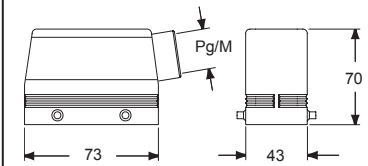

### CAVW and MAVW

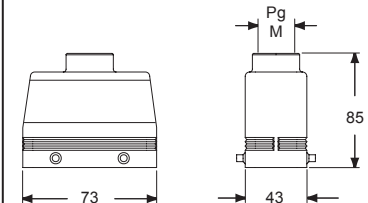

### CHCW G

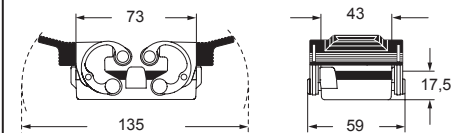

### CAVW G and MAVW G

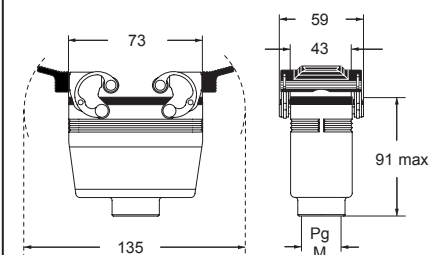

For fixing on housings

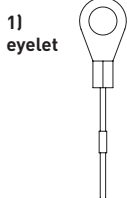

For fixing on hoods

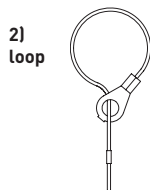

**CAUS** Type 4/4X/12



# CH - CA and MH - MA W-TYPE for aggressive environments

inserts		page:
CD	40 poles + ⊕	70
CDD	72 poles + ⊕	79
CDS	27 poles + ⊕	-
CDSH	27 poles + ⊕	88
CNE	16 poles + ⊕	112
CSE	16 poles + ⊕	-
CSH	16 poles + ⊕	112
CSH S	16 poles + ⊕	124
CCE	16 poles + ⊕	132
CMSH, CMCE	6+2 (aux) poles + ⊕	138 - 139
CSS	16 poles + ⊕	150
CT, CTS (10A) *	40 poles + ⊕	156
CT, CTSE (16A) *	16 poles + ⊕	162
CQE	32 poles + ⊕	170
CQEE	40 poles + ⊕	176
CP	6 poles + ⊕	178
CX	6/12, 6/36 and 12/2 poles + ⊕	197 - 199
CX	4/0 and 4/2 poles + ⊕	200 - 201
MIXO	4 modules	232 - 287

\*) only for enclosure CHIW 16

## housings and cover

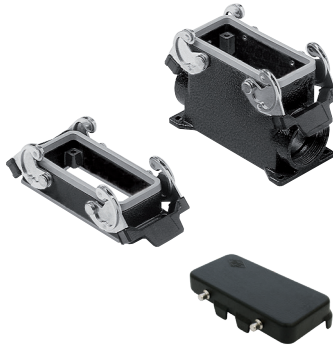

## hoods and cover



description	part No.	entry Pg	part No.	entry M	part No.	entry Pg	part No.	entry M
bulkhead mounting housing with levers and gasket	<b>CHIW 16</b>	--						
surface mounting housing, with levers, high construction	<b>CAPW 16.21</b>	21	<b>MAPW 16.32</b>	32				
cover with 4 pegs (for enclosures with 2 levers) 1)	<b>CHCW 16</b>							
enclosure with pegs, side entry					<b>CHOW 16</b>	21	<b>MHOW 16.25</b>	25
enclosure with pegs, side entry							<b>MHOW 16.32</b>	32
enclosure with pegs, side entry, high construction					<b>CAOW 16.29</b>	29	<b>MAOW 16.32</b>	32
enclosure with pegs, side entry, high construction							<b>MAOW 16.40</b>	40
enclosure with pegs, top entry					<b>CHVW 16</b>	21	<b>MHVW 16.25</b>	25
enclosure with pegs, top entry							<b>MHVW 16.32</b>	32
enclosure with pegs, top entry, high construction					<b>CAVW 16.29</b>	29	<b>MAVW 16.32</b>	32
enclosure with pegs, top entry, high construction							<b>MAVW 16.40</b>	40
cover with 2 levers (for enclosures with 4 pegs) 2)	<b>CHCW 16 G</b>							
enclosure with levers and gasket, top entry, high construction	<b>CAVW 16 G29</b>	29	<b>MAVW 16 G32</b>	32				

### panel cut-out for bulkhead mounting housings

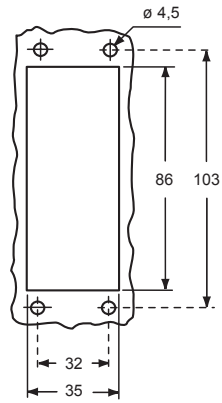

### For fixing on housings

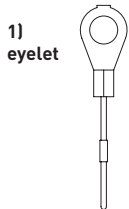

### For fixing on hoods

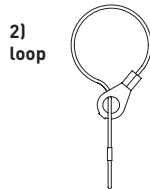

### CHIW

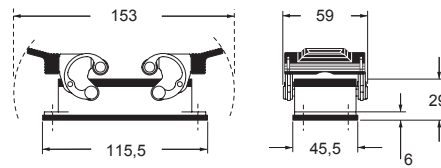

### CAPW and MAPW

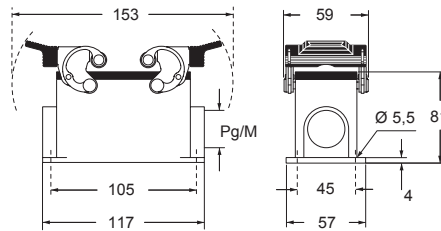

### CHCW

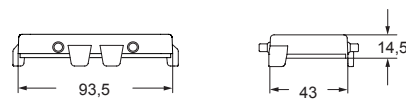

### CHOW (CAOW) and MHOW (MAOW)

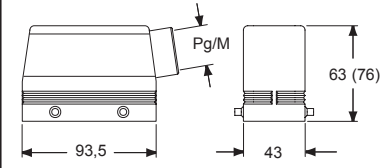

### CHVW (CAVW) and MHVW (MAVW)

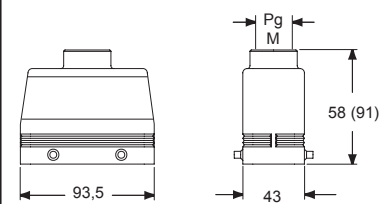

### CHCW G

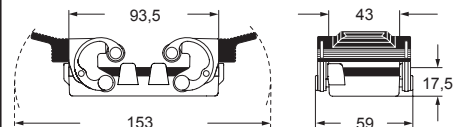

### CAVW G and MAVW G

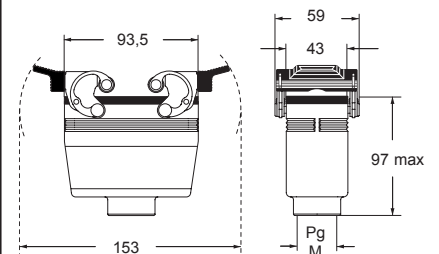

**CAUS** Type 4/4X/12



# CH - CA and MH - MA W-TYPE for aggressive environments

inserts		page:
CD	64 poles + ⊕	72
CDD	108 poles + ⊕	81
CDS	42 poles + ⊕	-
CDSH	42 poles + ⊕	89
CNE	24 poles + ⊕	113
CSE	24 poles + ⊕	-
CSH	24 poles + ⊕	113
CSH S	24 poles + ⊕	125
CCE	24 poles + ⊕	133
CMSH	10+2 (aux) poles + ⊕	140
CMCE	10+2 (aux) poles + ⊕	141
CSS	24 poles + ⊕	151
CT, CTS (10A) *	64 poles + ⊕	157
CT, CTSE (16A) *	24 poles + ⊕	163
CQE	46 poles + ⊕	171
CQEE	64 poles + ⊕	177
CX	4/8 and 6/6 poles + ⊕	204 and 206
MIXO	6 modules	232 - 287

\*) only for enclosure CHIW 24

## housings and cover



## hoods and cover

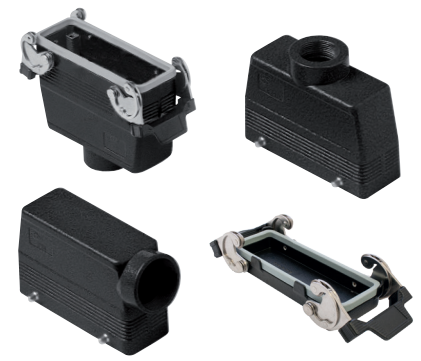

description	part No.	entry Pg	part No	entry M	part No.	entry Pg	part No.	entry M
bulkhead mounting housing with levers and gasket	<b>CHIW 24</b>	--						
surface mounting housing, with levers, high construction	<b>CAPW 24.21</b>	21	<b>MAPW 24.32</b>	32				
cover with 4 pegs (for enclosures with 2 levers) 1)	<b>CHCW 24</b>							
enclosure with pegs, side entry					<b>CHOW 24</b>	21	<b>MHOW 24.25</b>	25
enclosure with pegs, side entry							<b>MHOW 24.32</b>	32
enclosure with pegs, side entry, high construction					<b>CAOW 24.29</b>	29	<b>MAOW 24.32</b>	32
enclosure with pegs, side entry, high construction							<b>MAOW 24.40</b>	40
enclosure with pegs, top entry					<b>CHVW 24</b>	21	<b>MHVW 24.25</b>	25
enclosure with pegs, top entry							<b>MHVW 24.32</b>	32
enclosure with pegs, top entry, high construction					<b>CAVW 24.29</b>	29	<b>MAVW 24.32</b>	32
enclosure with pegs, top entry, high construction							<b>MAVW 24.40</b>	40
cover with 2 levers (for enclosures with 4 pegs) 2)	<b>CHCW 24 G</b>							
enclosure with levers and gasket, top entry	<b>CHVW 24 G</b>	21	<b>MHVW 24 G32</b>	32				

## panel cut-out for bulkhead mounting housings

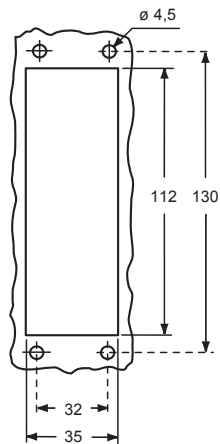

### For fixing on housings

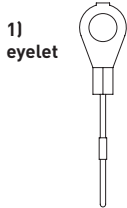

### For fixing on hoods

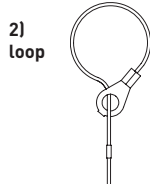

**CAIUS** Type 4/4X/12



## CHIW

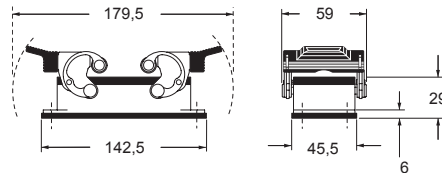

## CAPW and MAPW

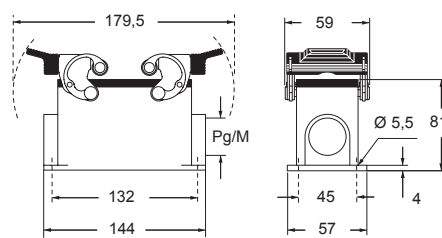

## CHCW

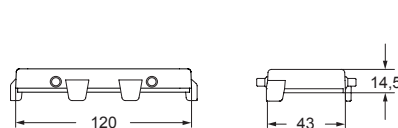

## CHOW (CAOW) and MHOW (MAOW)

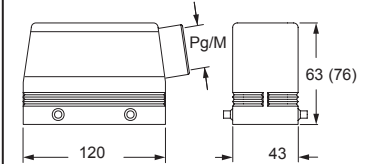

## CHVW (CAVW) and MHVW (MAVW)

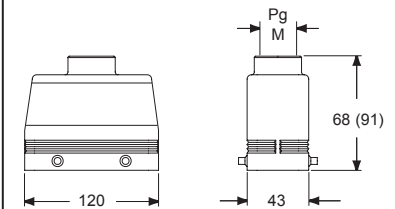

## CHCW G

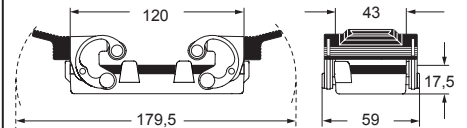

## CHVW G and MHVW G

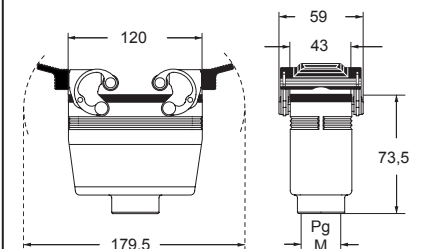



# CH and W-TYPE for aggressive environments

inserts		page:
CD	80 poles + ⊕	73
CDD	144 poles + ⊕	82
CDS	54 poles + ⊕	-
CDSH	54 poles + ⊕	90
CNE	32 poles + ⊕	114
CSE	32 poles + ⊕	-
CSH	32 poles + ⊕	114
CSH S	32 poles + ⊕	126
CCE	32 poles + ⊕	134
CSS	32 poles + ⊕	152
CTSE (16A) *	32 poles + ⊕	164
CQE	64 poles + ⊕	172
CME	12+4 (aux) poles + ⊕	142
CMSH	12+4 (aux) poles + ⊕	142
CMCE	12+4 (aux) poles + ⊕	143
CP	12 poles + ⊕	179
MIXO	4 + 4 modules	232 - 287

\*) only for enclosure CHIW 32

insert dimensions:  
2 x (77,5 x 27) mm

## housings and cover

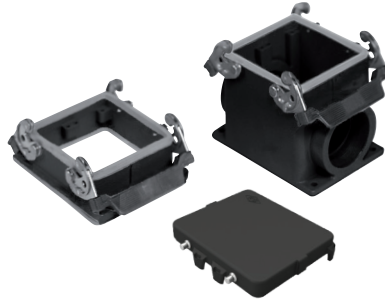

## hoods and cover

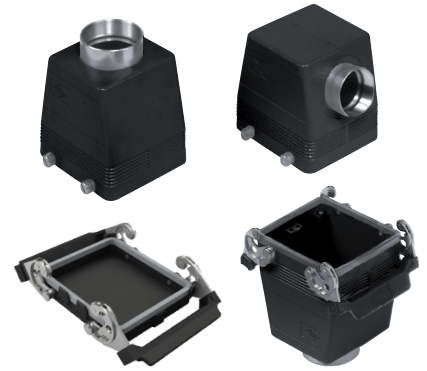

description	part No.	entry Pg	part No	entry M	part No.	entry Pg	part No.	entry M
bulkhead mounting housing with levers and gasket	<b>CHIW 32</b>	--						
surface mounting housing, with levers	<b>CHPW 32</b>	36	<b>MHPW 32.50</b>	50				
cover with 4 pegs (for enclosures with 2 levers) 1)	<b>CHCW 32</b>							
enclosure with pegs, side entry					<b>CHOW 32</b>	36	<b>MHOW 32.40</b>	40
enclosure with pegs, top entry					<b>CHVW 32</b>	36	<b>MHVW 32.40</b>	40
cover with 2 levers (for enclosures with 4 pegs) 2)					<b>CHCW 32 G</b>			
enclosure with levers and gasket, top entry					<b>CHVW 32 G</b>	36	<b>MHVW 32 G40</b>	40

panel cut-out for bulkhead mounting housings

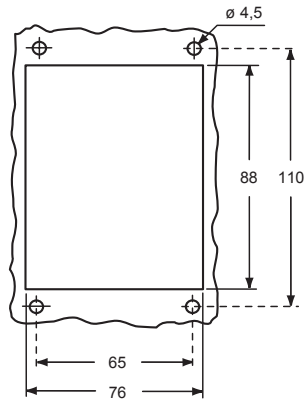

For fixing on housings

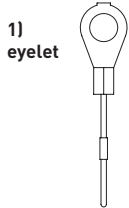

For fixing on hoods

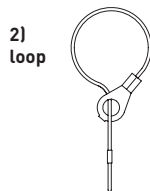

### CHIW

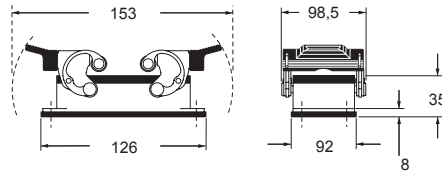

### CHPW and MHPW

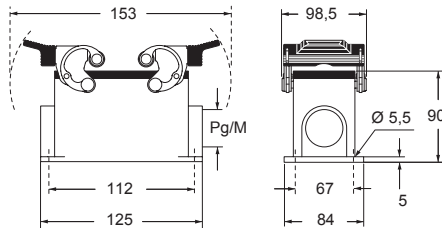

### CHCW

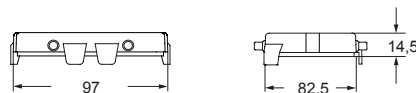

### CHOW and MHOW

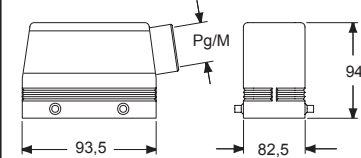

### CHVW and MHVW

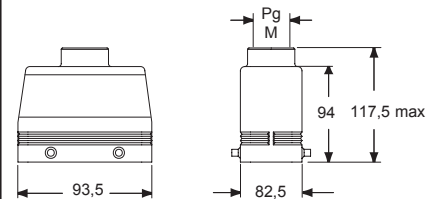

### CHCW G

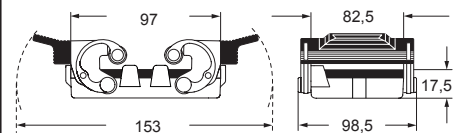

### CHVW G and MHVW G

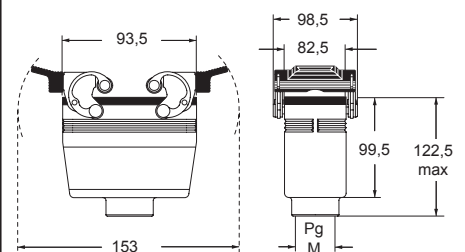

**CAUS** Type 4/4X/12



# CH and MH W-TYPE for aggressive environments

inserts		page:
CD	128 poles + ⊕	74
CDD	216 poles + ⊕	83
CDS	84 poles + ⊕	-
CDSH	84 poles + ⊕	91
CNE	48 poles + ⊕	115
CSE	48 poles + ⊕	-
CSH	48 poles + ⊕	115
CSH S	48 poles + ⊕	127
CCE	48 poles + ⊕	135
CME	20+4 (aux) poles + ⊕	144
CMSH	20+4 (aux) poles + ⊕	144
CSS	48 poles + ⊕	153
CTSE (16A) *)	48 poles + ⊕	165
CQE	92 poles + ⊕	173
MIXO	6 + 6 modules	232 - 287

\*) only for enclosure CHIW 48 LS

insert dimensions:  
2 x (104 x 27) mm

## bulkhead and surface mounting housings



## hoods



description	part No.	entry Pg	part No.	entry M	part No.	entry Pg	part No.	entry M
bulkhead mounting housings, with lever, gasket and cover	<b>CHIW 48 LS</b>	--						
surface mounting housings, with lever and cover	<b>CHPW 48 LS</b>	36 x 1/2	<b>MHPW 48 LS40</b>	40 x 1/2				
side entry, with pegs					<b>CHOW 48 L</b>	36	<b>MHOW 48 L40</b>	40
top entry, with pegs					<b>CHVW 48 L</b>	36	<b>MHVW 48 L40</b>	40

### panel cut-out for bulkhead mounting housings

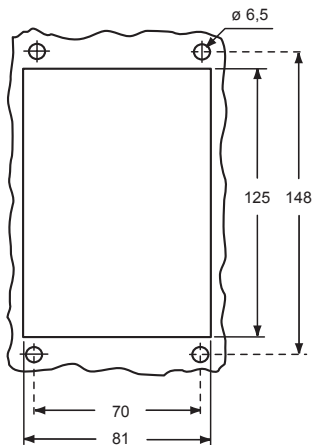

### CHIW LS

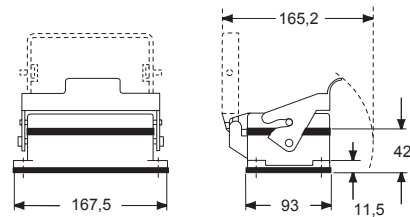

### CHPW LS and MHPW LS

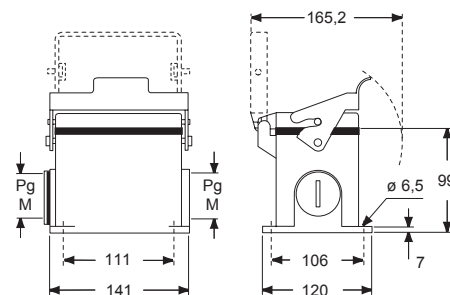

### CHOW L and MHOW L

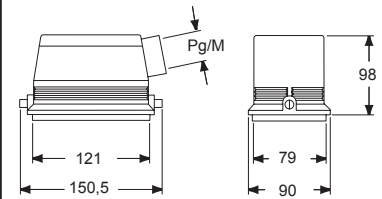

### CHVW L and MHVW L

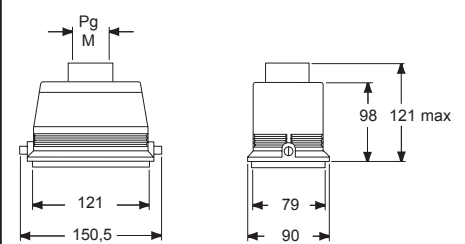

**CAUS**® Type 4/4X/12



# CH - CA and MH - MA W-TYPE for aggressive environments

<b>inserts</b>		<b>page:</b>
CD	50 poles + ⊕	71
CDD	76 poles + ⊕	80
CDA	32 poles + ⊕	102
CSAH	32 poles + ⊕	103
CDC	32 poles + ⊕	106

insert dimensions:  
2 x (66 x 16) mm

CHCW 50 and CHCW 50 G covers cannot be used together with coding pins. If this application is required, please contact ILME SpA.

## housings and cover



## hoods and cover



description	part No.	entry Pg	part No.	entry M	part No.	entry Pg	part No.	entry M
bulkhead mounting housings with lever and gasket	<b>CHIW 50</b>	--						
surface mounting housing, with lever	<b>CHPW 50.21</b>	21	<b>MHPW 50.32</b>	32				
surface mounting housing, with lever	<b>CHPW 50.229</b>	29 x 2	<b>MHPW 50.240</b>	40 x 2				
cover with 4 pegs (for housings with 2 levers) 1)	<b>CHCW 50</b>							
enclosure with pegs, side entry					<b>CHOW 50</b>	21	<b>MHOW 50.25</b>	25
enclosure with pegs, side entry							<b>MHOW 50.32</b>	32
enclosure with pegs, side entry, high construction					<b>CAOW 50.29</b>	29	<b>MAOW 50.32</b>	32
enclosure with pegs, top entry, high construction					<b>CAVW 50.29</b>	29	<b>MAVW 50.32</b>	32
cover with 2 levers (for enclosures with 4 pegs) 2)					<b>CHCW 50 G</b>			

panel cut-out for bulkhead mounting housings

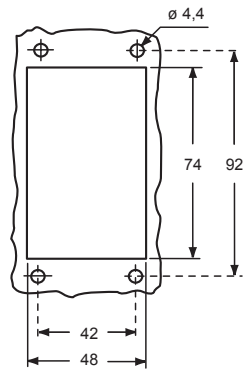

For fixing on housings

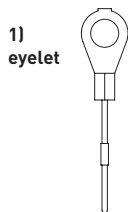

For fixing on hoods

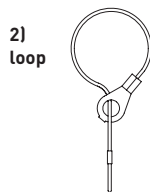

### CHIW

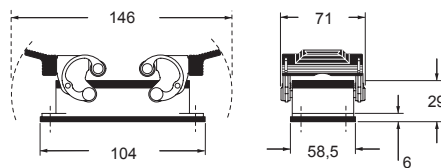

### CHPW and MHPW

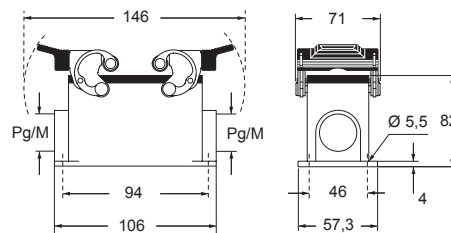

### CHCW



### CHOW (CAOW) and MHOW (MAOW)

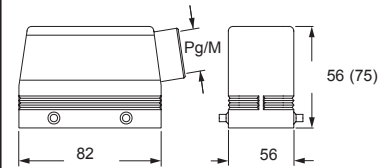

### CAVW and MAVW

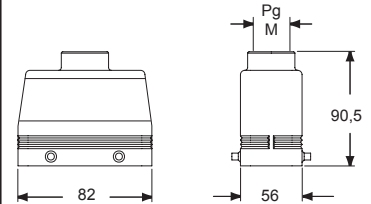

### CHCW G

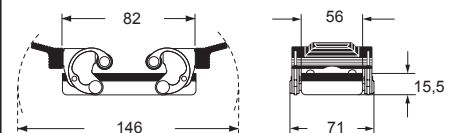

**CAIUS**® Type 4/4X/12



## E-Xtreme® series

## TECHNICAL FEATURES

The protection is granted also in case of impact with stones and sand. The materials are able to withstand UV radiations, a wide temperature range and harsh chemicals.

The E-Xtreme® series is available in the full range of ILME aluminum hoods and housings versions.

## Applicable test standards

EN 61984:2009-06	Connectors - Safety requirements and tests
EN 60529: 1991 + A1: 2000 + A2: 2013	Degrees of protection provided by enclosures (IP code)
EN ISO 9227: 2012	Corrosion tests in artificial atmospheres - Salt spray tests
ASTM B117-16	Standard practice for operating salt spray (fog) apparatus
EN 60512 (series)	Connectors for electronic equipment - Tests and measurement
EN 60068-2-68: 1996	Environmental testing - Part 2-68: Tests - Test L: Dust and sand
EN ISO 20567-1: 2005	Paints and varnishes -- Determination of stone-chip resistance of coatings -- Part 1: Multi-impact testing

## General specifications

Material	Aluminum die-cast
Painting	Epoxy powder coating
Colour	RAL 7016 (dark grey)
Locking lever, springs and pegs	Stainless steel
Lever handle	C-TYPE lever: Polyamide V-TYPE lever: Stainless steel
Gasket	FKM
Silicone-based compounds	Free (except version for -60 °C... +180 °C)
EN ISO 9227: 2012	3.000 hours (V-TYPE lever and hood with moulded pegs) 2.000 hours (C-TYPE lever and hood with riveted stainless steel bolts)
Temperature limits	-40 °C... +125 °C (-60 °C... +180 °C with silicone gasket)
Degree of protection according to IEC/EN 60529 (in mated and locked condition)	IP44, IP65/IP69, IP66/IP69, IP66/IP67/IP69, IP66/IP68/IP69
Stone chipping test	ISO 20567-1
Dust and sand blasting test	EN 60068-2-68
Vibration test	EN 61373 cat. 1B, 3 axis EN 60068-2-6 10+500 Hz 0,35mm/5g break point 60, 1 Hz 3 axis
Shock test	EN 61373 cat. 1B, 3 axis
UV resistance	EN ISO 4892-2, EN 50467 on locked housings
Ozone resistance	EN 50467 on locked housings
Chemical resistance	Cleaning fluids, anti-freezing fluids, mineral and synthetic oils, cooling fluids, diesel fuel

# E-Xtreme® series

## ADVANTAGES

Metal hoods and housings intended for **extremely demanding environments**, with special protective treatment under painting.

Their **special patented protective coating** assures a high level of protection against the corrosion even in case of long term exposure to salt mist.

- 3.000 hours in salt spray tests



- IP66, IP67, IP69 degree of protection (EN 60529)

- corrosion-proof aluminium with a special coating under the powder painting colour RAL 7016 dark grey

- FKM gasket (-40 °C...+180 °C) or silicone gasket (-60 °C...+180 °C)

- V-TYPE lever or C-TYPE lever, hoods with moulded pegs or riveted stainless steel bolts

- durable protection against damage caused by stone chip, icing, salt mist, UV radiations and harsh gases

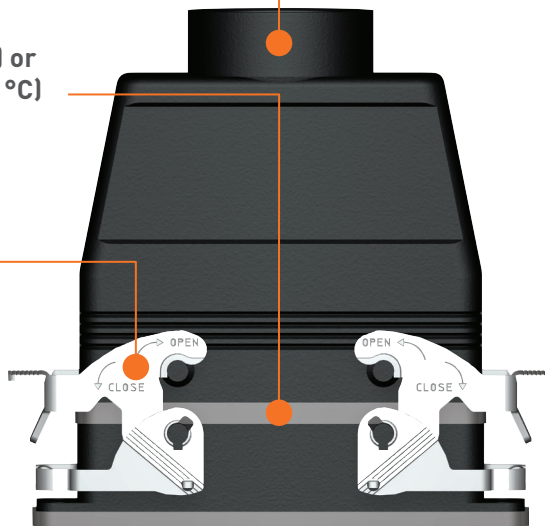

icing



very low temperatures



salt mist



impact resistant



UV radiations



chemical resistant



inserts		page:
CDD	42 poles + ⊕	78
CDS	18 poles + ⊕	-
CDSH	18 poles + ⊕	87
CNE	10 poles + ⊕	111
CSE	10 poles + ⊕	-
CSH	10 poles + ⊕	111
CSH S	10 poles + ⊕	123
CCE	10 poles + ⊕	131
CMSH	3+2 (aux) poles + ⊕	136
CMCE	3+2 (aux) poles + ⊕	137
CSS	10 poles + ⊕	149
CT, CTSE (16A) *)	10 poles + ⊕	161
CQE	18 poles + ⊕	169
CX	8/24 poles + ⊕	194
MIXO	3 modules	232 - 287

\*) can be used only in bulkhead mounting housings

**bulkhead mounting housings with single lever in stainless steel**



**3.000 hrs**

**surface mounting housings with single lever in stainless steel**



**2.000 hrs**

description	part No.	entry
with lever and gasket, size "44.27"	<b>C7IE 06 L</b>	M
with lever, size "44.27"	<b>M7P 06 L20</b>	20
with lever, size "44.27"	<b>M7PE 06 L220</b>	20 x 2
with lever, high construction, size "44.27"	<b>M7APE 06 L32</b>	32
with lever, high construction, size "44.27"	<b>M7APE 06L232</b>	32 x 2
with lever, high construction, size "44.27"	<b>M7APE 06 L40</b>	40
with lever, high construction, size "44.27"	<b>M7APE 06L240</b>	40 x 2

**TECHNICAL DETAILS:**

- the lever, due to the vertical closing movement, offers an IP66/IP67 degree of protection (according to EN 60529) when fitted with a complete and coupled connector and used with ILME hoods in die cast aluminum with pegs (without adapter, for further information please contact ILME S.p.A.)
- 3.000 hours in salt spray tests (EN ISO 9227) for bulkhead enclosures with V-TYPE lever and hood with moulded pegs (low number of mating cycles)
- 2.000 hours in salt spray tests (EN ISO 9227) for surface mounting housings
- temperature limits: -40 °C ... +125 °C on request -60 °C ... +180 °C with silicone gasket (125 °C - 180 °C with RY inserts)

**C7IE L**

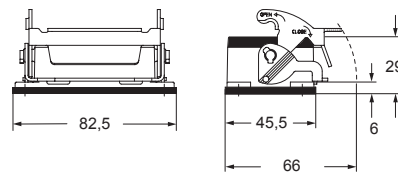

panel cut-out for bulkhead mounting housings

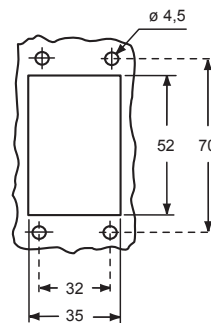

**M7PE L - M7APE L**

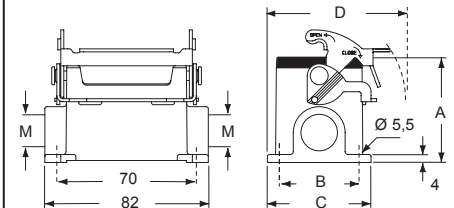

type	A	B	C	D
<b>M7PE 06 L</b>	53	40	52	70
<b>M7APE 06 L</b>	74	45	57	72,5

For bulkhead mounting housings, IP66/IP67 degree of protection is guaranteed for mounting on a sufficiently rigid panel; use suitable length M4 screws (negligible surface buckling when subjected to tightening couple on the fixing screws of 0,8 - 1,2 Nm or deformation caused by the weight of the complete connector).

In case of insufficient rigidity use of C7.. FL counterflanges (page 443) is recommended, in which case use suitable length M4 screws and M4 (on the enclosure) and M4 (on the counterflange) flat/spring washers with M4 locknut.

In addition, the panel surface in contact with the counterflange gasket of the bulkhead mounting housings must be free from defects (deep scratches, grooves, burrs) that could negatively affect the performance of the gasket.

**CAIUS** Type 4/4X/12





# MH - MF standard version E-Xtreme®

inserts		page:
CDD	24 poles + ⊕	76
CDS	9 poles + ⊕	-
CDSH	9 poles + ⊕	86
CDSH NC	6 poles + ⊕	95
CNE	6 poles + ⊕	110
CSE	6 poles + ⊕	-
CSH	6 poles + ⊕	110
CSH S	6 poles + ⊕	122
CCE	6 poles + ⊕	130
CSS	6 poles + ⊕	148
CQE	10 poles + ⊕	168
MIXO	2 modules	232 - 28

## hoods with 2 moulded pegs

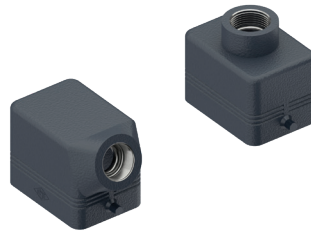

3.000 hrs

## hoods with 2 moulded pegs



3.000 hrs

description	part No.	entry M	part No.	entry M
with pegs, side entry	<b>MHOE 06 L20M</b>	20		
with pegs, side entry	<b>MHOE 06 L25M</b>	25		
with pegs, side entry, high construction, without adapter *			<b>MFOE 06 L32M</b>	32
with pegs, side entry, high construction, without adapter *			<b>MFOE 06 L40M</b>	40
with pegs, top entry	<b>MHVE 06 L20M</b> <sup>1)</sup>	20		
with pegs, top entry	<b>MHVE 06 L25M</b> <sup>1)</sup>	25		
with pegs, top entry, high construction, without adapter *			<b>MFVE 06 L32M</b>	32
with pegs, top entry, high construction, without adapter *			<b>MFVE 06 L40M</b>	40

\* enclosure without adapter, threaded on the body, to be used only with a complete cable gland.

<sup>1)</sup> cannot be used with MIXO series

### TECHNICAL DETAILS:

- 3.000 hours in salt spray tests (EN ISO 9227) for bulkhead enclosures with V-TYPE lever and hood with moulded pegs (low number of mating cycles)
- 2.000 hours in salt spray tests (EN ISO 9227) with other E-Xtreme® housings
- temperature limits: -40 °C ... +125 °C on request -60 °C ... +180 °C with silicone gasket (125 °C - 180 °C with RY inserts)
- alternatively, hoods with pegs are coupled with fixed enclosures:
  - C7 E-Xtreme®, IP66/IP67, page 530
  - C-TYPE E-Xtreme®, IP66, page 542

### MHOE L..M

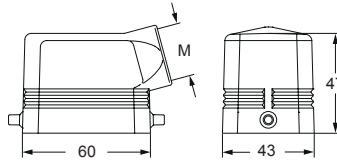

### MFOE L..M

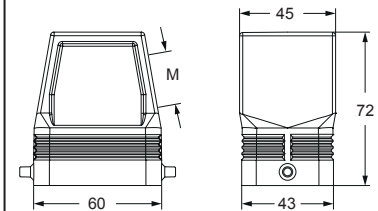

### MHVE L..M

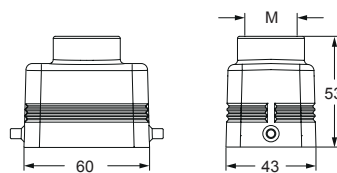

### MFVE L..M

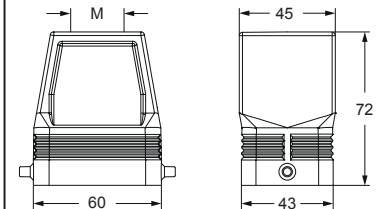

**CAVUS**® Type 4/4X/12



IP67 if hoods with fused pegs and without adapters coupled with IP67 housings according to the type of lever also IP69 according to IEC/EN 60529

inserts		page:
CDD	42 poles + ⊕	78
CDS	18 poles + ⊕	-
CDSH	18 poles + ⊕	87
CNE	10 poles + ⊕	111
CSE	10 poles + ⊕	-
CSH	10 poles + ⊕	111
CSH S	10 poles + ⊕	123
CCE	10 poles + ⊕	131
CMSH	3+2 (aux) poles + ⊕	136
CMCE	3+2 (aux) poles + ⊕	137
CSS	10 poles + ⊕	149
CT, CTSE (16A) *)	10 poles + ⊕	161
CQE	18 poles + ⊕	169
CX	8/24 poles + ⊕	194
MIXO	3 modules	232 - 287

\*) can be used only in bulkhead mounting housings

**bulkhead mounting housings with 2 levers in stainless steel**



**3.000 hrs**

**surface mounting housings with 2 levers in stainless steel**



**2.000 hrs**

description	part No.	part No.	entry M
with levers and gasket, size "57.27"	<b>C7IE 10</b>		
with levers, size "57.27"		<b>M7PE 10.20</b>	20
with levers, size "57.27"		<b>M7PE 10.220</b>	20 x 2
with levers, high construction, size "57.27"		<b>M7APE 10.32</b>	32
with levers, high construction, size "57.27"		<b>M7APE 10.232</b>	32 x 2
with levers, high construction, size "57.27"		<b>M7APE 10.40</b>	40
with levers, high construction, size "57.27"		<b>M7APE 10.240</b>	40 x 2

**TECHNICAL DETAILS:**

- the lever, due to the vertical closing movement, offers an IP66/IP67 degree of protection (according to EN 60529) when fitted with a complete and coupled connector and used with ILME hoods in die cast aluminum with pegs (without adapter, for further information please contact ILME S.p.A.)
- 3.000 hours in salt spray tests (EN ISO 9227) for bulkhead enclosures with V-TYPE lever and hood with moulded pegs (low number of mating cycles)
- 2.000 hours in salt spray tests (EN ISO 9227) for surface mounting housings
- temperature limits: -40 °C ... +125 °C on request -60 °C ... +180 °C with silicone gasket (125 °C - 180 °C with RY inserts)

**C7IE**

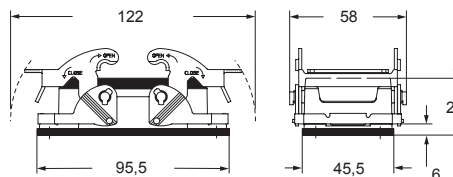

panel cut-out for bulkhead mounting housings

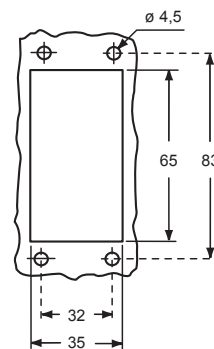

**M7PE - M7APE**

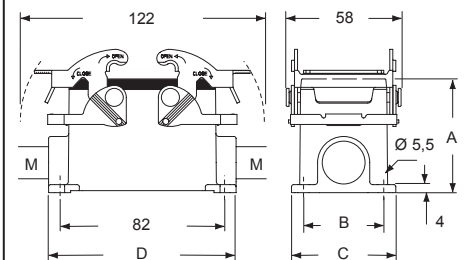

type	A	B	C	D
<b>M7PE 10</b>	57	40	52	93,5
<b>M7APE 10</b>	74	45	57	94

For bulkhead mounting housings, IP66/IP67 degree of protection is guaranteed for mounting on a sufficiently rigid panel; use suitable length M4 screws (negligible surface buckling when subjected to tightening couple on the fixing screws of 0,8 - 1,2 Nm or deformation caused by the weight of the complete connector).

In case of insufficient rigidity use of C7.. FL counterflanges (page 443) is recommended, in which case use suitable length M4 screws and M4 (on the enclosure) and M4 (on the counterflange) flat/spring washers with M4 locknut.

In addition, the panel surface in contact with the counterflange gasket of the bulkhead mounting housings must be free from defects (deep scratches, grooves, burrs) that could negatively affect the performance of the gasket.

**CAIUS** Type 4/4X/12



E-Xtreme®

# MH - MF standard version E-Xtreme®

inserts		page:
CDD	42 poles + ⊕	78
CDS	18 poles + ⊕	-
CDSH	18 poles + ⊕	87
CNE	10 poles + ⊕	111
CSE	10 poles + ⊕	-
CSH	10 poles + ⊕	111
CSH S	10 poles + ⊕	123
CCE	10 poles + ⊕	131
CMSH	3+2 (aux) poles + ⊕	136
CMCE	3+2 (aux) poles + ⊕	137
CSS	10 poles + ⊕	149
CQE	18 poles + ⊕	169
CX	8/24 poles + ⊕	194
MIXO	3 modules	232 - 287

## hoods with 4 moulded pegs



**3.000 hrs**

## hoods with 4 moulded pegs



**3.000 hrs**

description	part No.	entry		part No.	entry	
		M	M		M	M
with pegs, side entry	<b>MHOE 10.20M</b>	20				
with pegs, side entry	<b>MHOE 10.25M</b>	25				
with pegs, side entry, high construction, without adapter *				<b>MHOE 10.25M</b>	32	
with pegs, side entry, high construction, without adapter *				<b>MFOE 10.40M</b>	40	
with pegs, top entry	<b>MHVE 10.20M **</b>	20				
with pegs, top entry	<b>MHVE 10.25M</b>	25				
with pegs, top entry, high construction, without adapter *				<b>MFVE 10.32M</b>	32	
with pegs, top entry, high construction, without adapter *				<b>MFVE 10.40M</b>	40	

\* enclosure without adapter, threaded on the body, to be used only with a complete cable gland.

\*\* can only be used with a complete cable gland (to be purchased separately)

### TECHNICAL DETAILS:

- 3.000 hours in salt spray tests (EN ISO 9227) for bulkhead enclosures with V-TYPE lever and hood with moulded pegs (low number of mating cycles)
- 2.000 hours in salt spray tests (EN ISO 9227) with other E-Xtreme® housings
- temperature limits: -40 °C ... +125 °C on request -60 °C ... +180 °C with silicone gasket (125 °C - 180 °C with RY inserts)
- alternatively, hoods with pegs are coupled with fixed enclosures:
  - C7 E-Xtreme®, IP66/IP67, page 532
  - C-TYPE E-Xtreme®, IP66, page 543

### MHOE..M

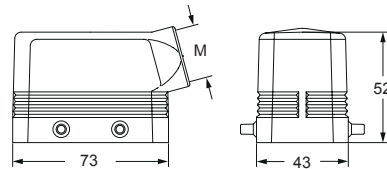

### MFOE..M

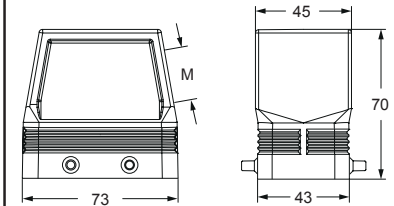

### MHVE..M

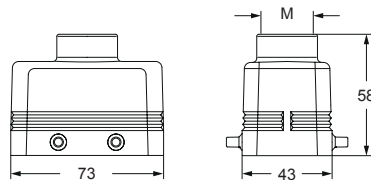

### MFVE..M

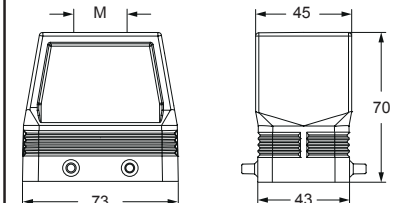

**CAUS**® Type 4/4X/12



IP66 if hoods with fused pegs and without adapters coupled with IP67 housings according to the type of lever also IP69 according to IEC/EN 60529

inserts		page:
CD	40 poles + ⊕	70
CDD	72 poles + ⊕	79
CDS	27 poles + ⊕	-
CDSH	27 poles + ⊕	88
CNE	16 poles + ⊕	112
CSE	16 poles + ⊕	-
CSH	16 poles + ⊕	112
CSH S	16 poles + ⊕	124
CCE	16 poles + ⊕	132
CMSH, CMCE	6+2 (aux) poles + ⊕	138 - 139
CSS	16 poles + ⊕	150
CT, CTS (10A) *)	40 poles + ⊕	156
CT, CTSE (16A) *)	16 poles + ⊕	162
CQE	32 poles + ⊕	170
CQEE	40 poles + ⊕	176
CP	6 poles + ⊕	178
CX	6/12, 6/36 and 12/2 poles + ⊕	197 - 199
CX	4/0 and 4/2 poles + ⊕	200 - 201
MIXO	4 modules	232 - 287

\*) can be used only in bulkhead mounting housings

**bulkhead mounting housings with 2 levers in stainless steel**

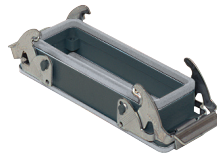

**3.000 hrs**

**surface mounting housings with 2 levers in stainless steel**

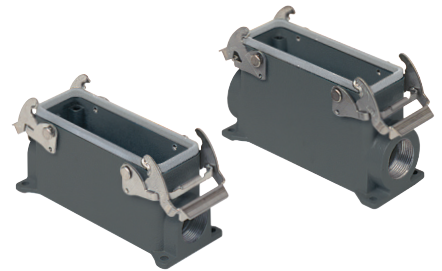

**2.000 hrs**

description	part No.	part No.	entry M
with levers and gasket, size "77.27"	<b>C7IE 16</b>		
with levers, size "77.27"		<b>M7PE 16.25</b>	25
with levers, size "77.27"		<b>M7PE 16.225</b>	25 x 2
with levers, high construction, size "77.27"		<b>M7APE 16.32</b>	32
with levers, high construction, size "77.27"		<b>M7APE 16.232</b>	32 x 2
with levers, high construction, size "77.27"		<b>M7APE 16.40</b>	40
with levers, high construction, size "77.27"		<b>M7APE 16.240</b>	40 x 2

**TECHNICAL DETAILS:**

- the lever, due to the vertical closing movement, offers an IP66/IP67 degree of protection (according to EN 60529) when fitted with a complete and coupled connector and used with ILME hoods in die cast aluminum with pegs (without adapter, for further information please contact ILME S.p.A.)
- 3.000 hours in salt spray tests (EN ISO 9227) for bulkhead enclosures with V-TYPE lever and hood with moulded pegs (low number of mating cycles)
- 2.000 hours in salt spray tests (EN ISO 9227) for surface mounting housings
- temperature limits: -40 °C ... +125 °C on request -60 °C ... +180 °C with silicone gasket (125 °C - 180 °C with RY inserts)

**C7IE**

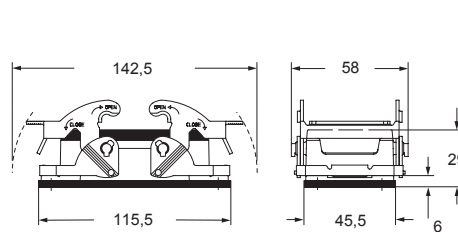

panel cut-out for bulkhead mounting housings

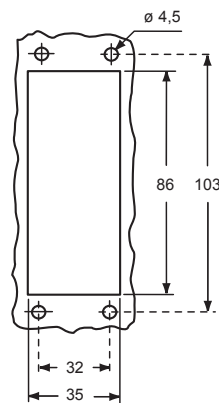

**M7PE - M7APE**

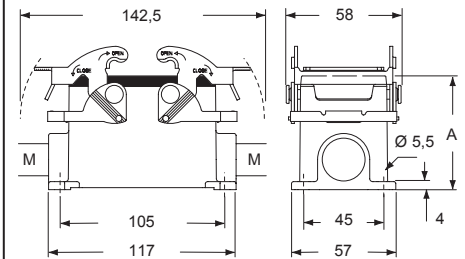

type	A
<b>M7PE 16</b>	63
<b>M7APE 16</b>	81

For bulkhead mounting housings, IP66/IP67 degree of protection is guaranteed for mounting on a sufficiently rigid panel; use suitable length M4 screws (negligible surface buckling when subjected to tightening couple on the fixing screws of 0,8 - 1,2 Nm or deformation caused by the weight of the complete connector).

In case of insufficient rigidity use of C7.. FL counterflanges (page 443) is recommended, in which case use suitable length M4 screws and M4 (on the enclosure) and M4 (on the counterflange) flat/spring washers with M4 locknut.

In addition, the panel surface in contact with the counterflange gasket of the bulkhead mounting housings must be free from defects (deep scratches, grooves, burrs) that could negatively affect the performance of the gasket.

**CAIUS** Type 4/4X/12



E-Xtreme®

# MH - MF standard version E-Xtreme®

inserts		page:
CD	40 poles + ⊕	70
CDD	72 poles + ⊕	79
CDS	27 poles + ⊕	-
CDSH	27 poles + ⊕	88
CNE	16 poles + ⊕	112
CSE	16 poles + ⊕	-
CSH	16 poles + ⊕	112
CSH S	16 poles + ⊕	124
CCE	16 poles + ⊕	132
CMSH, CMCE	6+2 (aux) poles + ⊕	138 - 139
CSS	16 poles + ⊕	150
CQE	32 poles + ⊕	170
CQEE	40 poles + ⊕	176
CP	6 poles + ⊕	178
CX	6/12, 6/36 and 12/2 poles + ⊕	197 - 199
CX	4/0 and 4/2 poles + ⊕	200 - 201
MIXO	4 modules	232 - 287

## hoods with 4 moulded pegs



3.000 hrs

## hoods with 4 moulded pegs



3.000 hrs

description	part No.	entry		part No.	entry	
		M	M		M	M
with pegs, side entry	<b>MHOE 16.25M</b>	25				
with pegs, side entry	<b>MHOE 16.32M</b>	32				
with pegs, side entry, high construction, without adapter *				<b>MFOE 16.32M</b>	32	
with pegs, side entry, high construction, without adapter *				<b>MFOE 16.40M</b>	40	
with pegs, top entry	<b>MHVE 16.25M **</b>	25				
with pegs, top entry	<b>MHVE 16.32M</b>	32				
with pegs, top entry, high construction, without adapter *				<b>MFVE 16.32M</b>	32	
with pegs, top entry, high construction, without adapter *				<b>MFVE 16.32M</b>	40	

\* enclosure without adapter, threaded on the body, to be used only with a complete cable gland.

\*\* can only be used with a complete cable gland (to be purchased separately)

### TECHNICAL DETAILS:

- 3.000 hours in salt spray tests (EN ISO 9227) for bulkhead enclosures with V-TYPE lever and hood with moulded pegs (low number of mating cycles)
- 2.000 hours in salt spray tests (EN ISO 9227) with other E-Xtreme® housings
- temperature limits: -40 °C ... +125 °C on request -60 °C ... +180 °C with silicone gasket (125 °C - 180 °C with RY inserts)
- alternatively, hoods with pegs are coupled with fixed enclosures:
  - C7 E-Xtreme®, IP66/IP67, page 534
  - C-TYPE E-Xtreme®, IP66, page 544

### MHOE..M

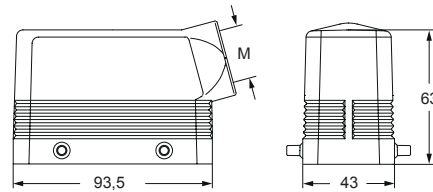

### MFOE..M

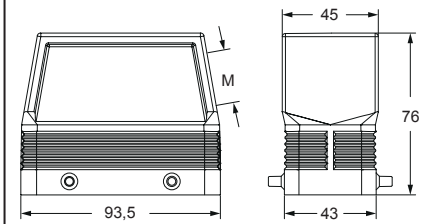

### MHVE..M

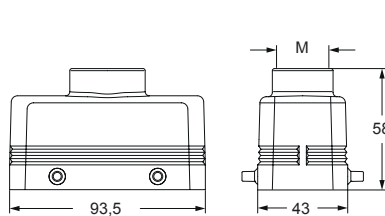

### MFVE..M

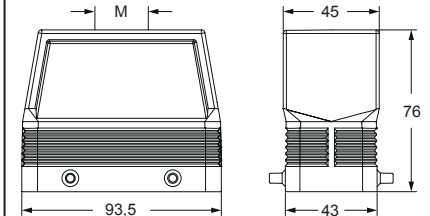

**CALUS**® Type 4/4X/12



IP66 if hoods with fused pegs and without adapters coupled with IP67 housings according to the type of lever also IP69 according to IEC/EN 60529

inserts		page:
CD	64 poles + ⊕	72
CDD	108 poles + ⊕	81
CDS	42 poles + ⊕	-
CDSH	42 poles + ⊕	89
CNE	24 poles + ⊕	113
CSE	24 poles + ⊕	-
CSH	24 poles + ⊕	113
CSH S	24 poles + ⊕	125
CCE	24 poles + ⊕	133
CMSH	10+2 (aux) poles + ⊕	140
CMCE	10+2 (aux) poles + ⊕	141
CSS	24 poles + ⊕	151
CT, CTS (10A) *	64 poles + ⊕	157
CT, CTSE (16A) *	24 poles + ⊕	163
CQE	46 poles + ⊕	171
CQEE	64 poles + ⊕	177
CX	4/8 and 6/6 poles + ⊕	204 and 206
MIXO	6 modules	232 - 287

\*) can be used only in bulkhead mounting housings

**bulkhead mounting housings with 2 levers in stainless steel**

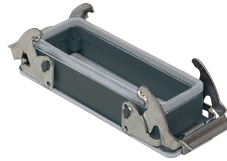

**3.000 hrs**

**surface mounting housings with 2 levers in stainless steel**



**2.000 hrs**

description	part No.	part No.	entry M
with levers and gasket, size "104.27"	<b>C7IE 24</b>		
with levers, size "104.27"		<b>M7PE 24.25</b>	25
with levers, size "104.27"		<b>M7PE 24.225</b>	25 x 2
with levers, high construction, size "104.27"		<b>M7APE 24.32</b>	32
with levers, high construction, size "104.27"		<b>M7APE 24.232</b>	32 x 2
with levers, high construction, size "104.27"		<b>M7APE 24.40</b>	40
with levers, high construction, size "104.27"		<b>M7APE 24.240</b>	40 x 2

**TECHNICAL DETAILS:**

- the lever, due to the vertical closing movement, offers an IP66/IP67 degree of protection (according to EN 60529) when fitted with a complete and coupled connector and used with ILME hoods in die cast aluminum with pegs (without adapter, for further information please contact ILME S.p.A.)
- 3.000 hours in salt spray tests (EN ISO 9227) for bulkhead enclosures with V-TYPE lever and hood with moulded pegs (low number of mating cycles)
- 2.000 hours in salt spray tests (EN ISO 9227) for surface mounting housings
- temperature limits: -40 °C ... +125 °C on request -60 °C ... +180 °C with silicone gasket (125 °C - 180 °C with RY inserts)

**C7IE**

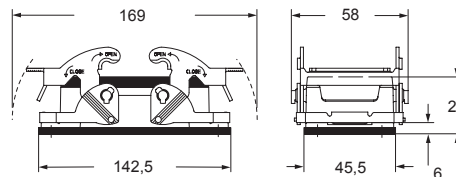

panel cut-out for bulkhead mounting housings

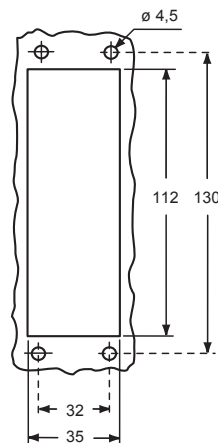

For bulkhead mounting housings, IP66/IP67 degree of protection is guaranteed for mounting on a sufficiently rigid panel; use suitable length M4 screws (negligible surface buckling when subjected to tightening couple on the fixing screws of 0,8 - 1,2 Nm or deformation caused by the weight of the complete connector). In case of insufficient rigidity use of C7.. FL counterflanges (page 443) is recommended, in which case use suitable length M4 screws and M4 (on the enclosure) and M4 (on the counterflange) flat/spring washers with M4 locknut. In addition, the panel surface in contact with the counterflange gasket of the bulkhead mounting housings must be free from defects (deep scratches, grooves, burrs) that could negatively affect the performance of the gasket.

**M7PE - M7APE**

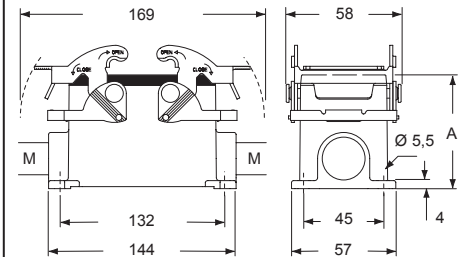

type	A
<b>M7PE 24</b>	63
<b>M7APE 24</b>	81

**CAIUS** Type 4/4X/12



E-Xtreme®



# MH - MF standard version E-Xtreme®

inserts		page:
CD	64 poles + ⊕	72
CDD	108 poles + ⊕	81
CDS	42 poles + ⊕	-
CDSH	42 poles + ⊕	89
CNE	24 poles + ⊕	113
CSE	24 poles + ⊕	-
CSH	24 poles + ⊕	113
CSH S	24 poles + ⊕	125
CCE	24 poles + ⊕	133
CMSH	10+2 (aux) poles + ⊕	140
CMCE	10+2 (aux) poles + ⊕	141
CSS	24 poles + ⊕	151
CQE	46 poles + ⊕	171
CQEE	64 poles + ⊕	177
CX	4/8 and 6/6 poles + ⊕	204 and 206
MIXO	6 modules	232 - 287

## hoods with 4 moulded pegs



3.000 hrs

## hoods with 4 moulded pegs



3.000 hrs

description	part No.	entry	part No.	entry
		M		
with pegs, side entry	<b>MHOE 24.25M</b>	25		
with pegs, side entry	<b>MHOE 24.32M</b>	32		
with pegs, side entry, high construction, without adapter *			<b>MFOE 24.32M</b>	32
with pegs, side entry, high construction, without adapter *			<b>MFOE 24.40M</b>	40
with pegs, top entry	<b>MHVE 24.25M **</b>	25		
with pegs, top entry	<b>MHVE 24.32M</b>	32		
with pegs, top entry	<b>MHVE 24.40M</b>	40		
with pegs, top entry, high construction, without adapter *			<b>MFVE 24.32M</b>	32
with pegs, top entry, high construction, without adapter *			<b>MFVE 24.40M</b>	40

\* enclosure without adapter, threaded on the body, to be used only with a complete cable gland.

\*\* can only be used with a complete cable gland (to be purchased separately)

### TECHNICAL DETAILS:

- 3.000 hours in salt spray tests (EN ISO 9227) for bulkhead enclosures with V-TYPE lever and hood with moulded pegs (low number of mating cycles)
- 2.000 hours in salt spray tests (EN ISO 9227) with other E-Xtreme® housings
- temperature limits: -40 °C ... +125 °C on request -60 °C ... +180 °C with silicone gasket (125 °C - 180 °C with RY inserts)
- alternatively, hoods with pegs are coupled with fixed enclosures:
  - C7 E-Xtreme®, IP66/IP67, page 536
  - C-TYPE E-Xtreme®, IP66, page 545

### MHOE..M

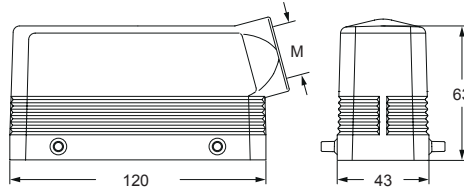

### MFOE..M

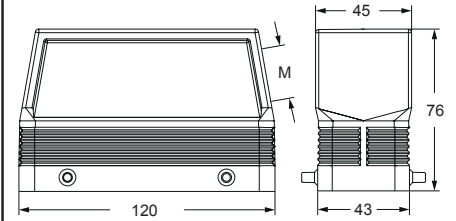

### MHVE..M

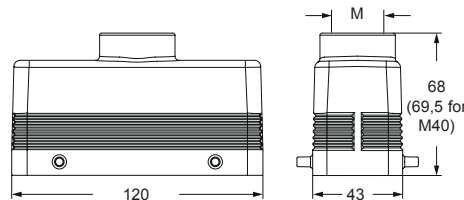

### MFVE..M

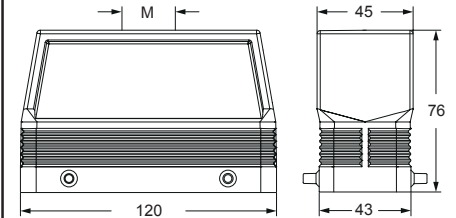

**CALUS**® Type 4/4X/12



IP67 if hoods with fused pegs and without adapters coupled with IP67 housings according to the type of lever also IP69 according to IEC/EN 60529

# CK - CKA and MKA for aggressive environments E-Xtreme®

inserts		page:
CK	3 poles + ⊕	58
CK	4 poles + ⊕	58
CKS	3 poles + ⊕	-
CKS	4 poles + ⊕	-
CKSH	3 poles + ⊕	63
CKSH	4 poles + ⊕	63
CD	8 poles	67
CQ4	2 poles + ⊕	182
CQ4 H	2 poles + ⊕	183
CQ4	3 poles + ⊕	184
CQ	5 poles + ⊕	186
CQ	7 poles + ⊕	187
CQ	12 poles + ⊕	189
CQ	21 poles + ⊕	190

## bulkhead mounting housings straight and angled

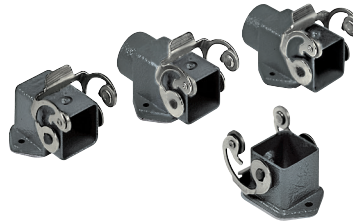

2.000 hrs

## hoods

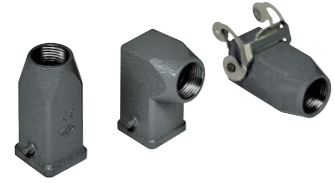

2.000 hrs

description	part No.	part No. (entry - M20)	part No.	part No. (entry - M20)
with stainless steel lever and gasket without cable entry, with stainless steel lever and gasket with cable entry, with stainless steel lever and gasket with cable entry, stainless steel lever and gasket bulkhead hole closed	<b>CKAXE 03 I</b> <b>CKAXE 03 IA</b>		<b>MKAXE IAP20</b> <b>MKAXE AP20</b>	
with pegs, top entry with pegs, top entry				<b>MKAE V20</b> <b>MKAE VA20</b>
with stainless steel lever, top entry				<b>MKAXE VG20</b>
gasket and screw kit for IP66/IP67/IP69 1) for CK, CKSH, CQ4, CQ 05, inserts	<b>CKR 65</b>		<b>CKR 65</b>	
gasket and screw kit for IP66/IP67/IP69 1) for CD 08 inserts	<b>CKR 65 D</b>		<b>CKR 65 D</b>	

1) To obtain the IP66/IP67/IP69 degree of protection, a kit with insert fixing screw and gasket can be purchased separately.  
Several inserts size "21.21" are already supplied with fixing screw and gasket, which ensures IP66/IP67/IP69 degree of protection. See list below, not including any special version:

- CQF/M 07, CQF/M 12
- CJ KF/M, CJF/M 4 /4/2 /8 /8/2
- CJK 8FT /8IFT /8MT /8IMT, CJK 8M
- CUK 2FT /3FT
- CX 1/2 BDF/M
- CLK 04 SCF /SCF-H /SCM
- CXL 2/4 PF /PM /PFH /PMH /SF /SM, CXL SF/M

NOTE: Housing type and colour may vary upon specific part No.

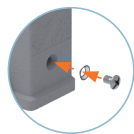

### TECHNICAL DETAILS:

- 2.000 hours in salt spray tests (EN ISO 9227)
- temperature limits: -40 °C ... +125 °C

**Note:**  
optional gasket for male insert in FKM material: **"CR 03 W"** (replace the gasket male inserts)

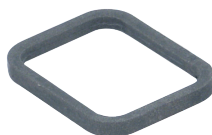

### CKAXE I

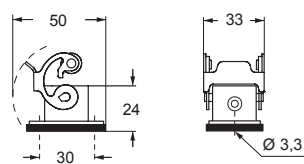

### CKAXE IA

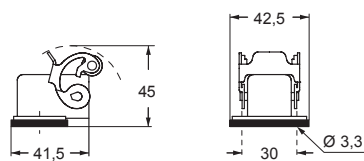

### MKAXE IAP (MKAXE AP)

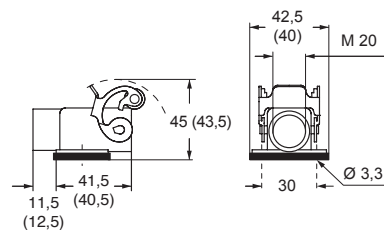

panel cut-out for bulkhead mounting housings

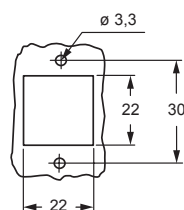

### MKAE V

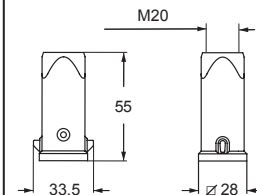

### MKAE VA

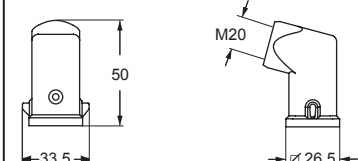

### MKAXE VG

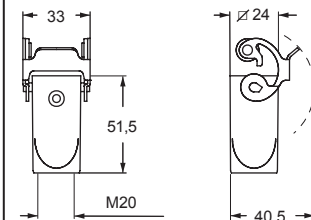

Type 12  
Type 4/4X only  
with CKR 65 (D)



IP66/IP67/IP69 with CKR 65 (D) 1)

# CK and MKA for aggressive environments E-Xtreme®

inserts		page:
CK	3 poles + ⊕	58
CK	4 poles + ⊕	58
CKS	3 poles + ⊕	-
CKS	4 poles + ⊕	-
CKSH	3 poles + ⊕	63
CKSH	4 poles + ⊕	63
CD	8 poles	67
CQ4	2 poles + ⊕	182
CQ4 H	2 poles + ⊕	183
CQ4	3 poles + ⊕	184
CQ	5 poles + ⊕	186
CQ	7 poles + ⊕	187
CQ	12 poles + ⊕	189
CQ	21 poles + ⊕	190

## angled bulkhead mounting housings



**2.000 hrs**

description	part No. (entry - M20 / M25)
-------------	---------------------------------

stainless steel lever, M20 fixing thread <sup>(1)</sup>	<b>MKAXE IAF20</b>
stainless steel lever, M25 fixing thread <sup>(1)</sup>	<b>MKAXE IAF25</b>
gasket and screw kit for IP66/IP67/IP69 <sup>1)</sup> for CK, CKSH, CQ4, CQ 05, inserts	<b>CKR 65</b>
gasket and screw kit for IP66/IP67/IP69 <sup>1)</sup> for CD 07/08 inserts	<b>CKR 65 D</b>

<sup>(1)</sup> locknut supplied on request, see catalogue cable glands (articles AS M20N and AS M25N metallic, AS M20L and AS M25L insulating).

<sup>1)</sup> To obtain the IP66/IP67/IP69 degree of protection, a kit with insert fixing screw and gasket can be purchased separately.  
Several inserts size "21.21" are already supplied with fixing screw and gasket, which ensures IP66/IP67/IP69 degree of protection. See list below, not including any special version:

- CQF/M 07, CQF/M 12
- CJ KF/M, CJF/M 4 /4/2 /8 /8/2
- CJK 8FT /8IFT /8MT /8IMT, CJK 8M
- CUK 2FT /3FT
- CX 1/2 BDF/M
- CLK 04 SCF /SCF-H /SCM
- CXL 2/4 PF /PM /PFH /PMH /SF /SM, CXL SF/M

NOTE: Housing type and colour may vary upon specific part No.

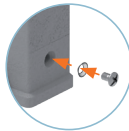

### MKAXE IAF

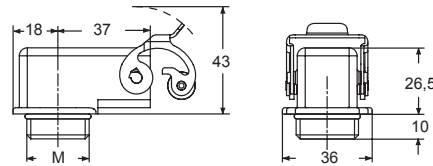

### panel cut-out

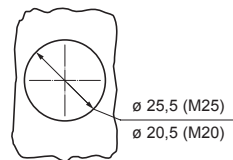

### USE OF THE LOCHNUT

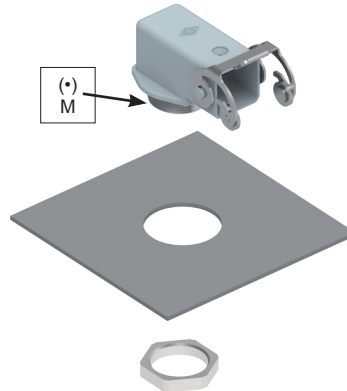

### TECHNICAL DETAILS:

- 2.000 hours in salt spray tests (EN ISO 9227)
- temperature limits: -40 °C ... +125 °C

### Note:

optional gasket for male insert in FKM material: **"CR 03 W"** (replace the gasket male inserts)

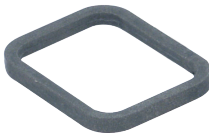

Type 12  
Type 4/4X only  
with CKR 65 (D)



IP66/IP67/IP69 with CKR 65 (D) <sup>1)</sup>

# CZ7 - MZ7 and MZ - MZA for aggressive environments E-Xtreme®

<b>inserts</b>		<b>page:</b>
CD	15 poles + ⊕	68
CDA	10 poles + ⊕	98
CSAH	10 poles + ⊕	99
CDC	10 poles + ⊕	104
MIXO	1 module	234 - 286

The covers for L and LG versions cannot be used together with coding pins. If this application is required, please contact ILME SpA.

## housings with single lever in stainless steel and cover

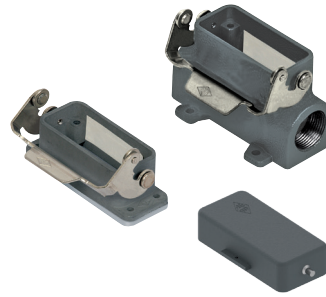

**2.000 hrs**

## hoods with riveted locking pegs and cover



**2.000 hrs**

description	part No.	part No	entry M	part No.	entry M
bulkhead mounting housing, with lever and gasket	<b>CZ7IE 15 L</b>				
surface mounting housing, with lever		<b>MZ7PE 15L225</b>	25 x 2		
cover with pegs and gasket (for 1 lever enclosures) 1)	<b>CZCE 15 L</b>				
with pegs and gasket, side entry				<b>MZOE 15 L20</b>	20
with pegs and gasket, side entry				<b>MZOE 15 L25</b>	25
with pegs and gasket, side entry, high construction				<b>MZAOE 15 L25</b>	25
with pegs and gasket, top entry				<b>MZVE 15 L20</b>	20
with pegs and gasket, side entry, high construction				<b>MZAVE 15 L25</b>	25
1 cover with lever (for enclosures with pegs) 2)				<b>CZ7CE 15 LG</b>	

### TECHNICAL DETAILS:

- The rigid lever, offers an IP66/IP67/IP69 degree of protection (according to EN 60529) when fitted with a complete and coupled connector and used with ILME standard hoods in die cast aluminum with pegs (without adapter, for further information please contact ILME S.p.A.)
- 2.000 hours in salt spray tests (EN ISO 9227)
- temperature limits: -40 °C ... +125 °C
- mechanical life: ≥ 500 cycles

#### For fixing on housings

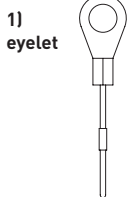

#### For fixing on hoods

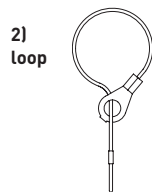

### CZ7IE L

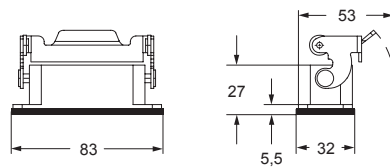

panel cut-out for bulkhead mounting housings

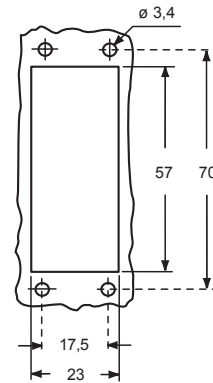

### MZ7PE L

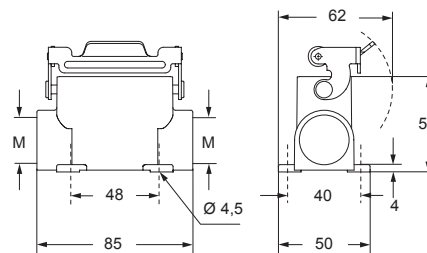

### CZCE L

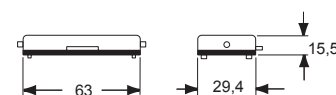

### MZOE L

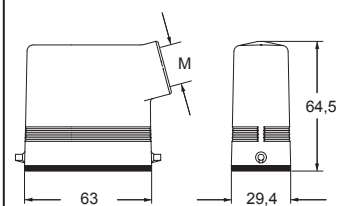

### MZAOE L and MZAVE L

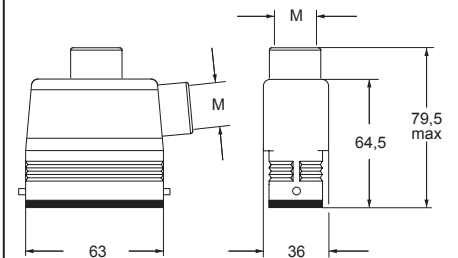

### MZVE L

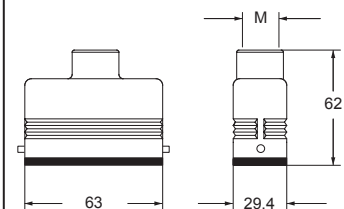

### CZ7CE LG

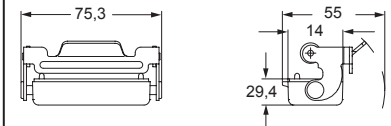

**CAIUS** Type 4/4X/12



# CZ7 - MZ7 and MZ - MZA for aggressive environments E-Xtreme®

inserts		page:
CD	25 poles + ⊕	69
CDD	38 poles + ⊕	77
CDA	16 poles + ⊕	100
CSAH	16 poles + ⊕	101
CDC	16 poles + ⊕	105

The covers for L and LG versions cannot be used together with coding pins. If this application is required, please contact ILME SpA.

## housings with single lever in stainless steel and cover

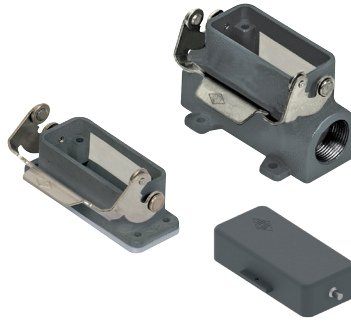

**2.000 hrs**

## hoods with riveted locking pegs and cover



**2.000 hrs**

description	part No.	part No	entry M	part No.	entry M
bulkhead mounting housing, with lever and gasket	<b>CZ7IE 25 L</b>				
surface mounting housing, with lever		<b>MZ7PE 25L225</b>	25 x 2		
cover with pegs and gasket (for 1 lever enclosures) 1)	<b>CZCE 25 L</b>				
with pegs and gasket, side entry				<b>MZOE 25 L20</b>	20
with pegs and gasket, side entry				<b>MZOE 25 L25</b>	25
with pegs and gasket, side entry, high construction				<b>MZAOE 25 L25</b>	25
with pegs and gasket, top entry				<b>MZVE 25 L20 *</b>	20
with pegs and gasket, side entry, high construction				<b>MZAVE 25 L25</b>	25
1 cover with lever (for enclosures with pegs) 2)				<b>CZ7CE 25 LG</b>	

### TECHNICAL DETAILS:

- The rigid lever, offers an IP66/IP67/IP69 degree of protection (according to EN 60529) when fitted with a complete and coupled connector and used with ILME standard hoods in die cast aluminum with pegs (without adapter, for further information please contact ILME S.p.A.)
- 2.000 hours in salt spray tests (EN ISO 9227: 2012)
- temperature limits: -40 °C ... +125 °C
- mechanical life: ≥ 500 cycles

#### For fixing on housings

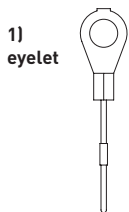

#### For fixing on hoods

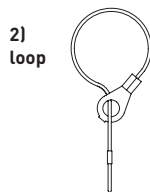

#### CZ7IE L

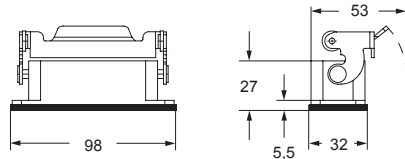

panel cut-out for bulkhead mounting housings

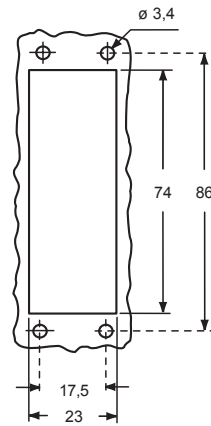

#### MZ7PE L

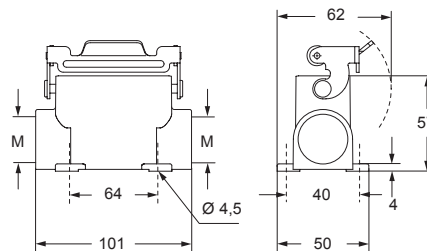

#### CZCE L

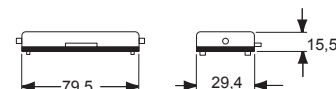

\* can only be used with a complete cable gland (to be purchased separately)

#### MZOE L

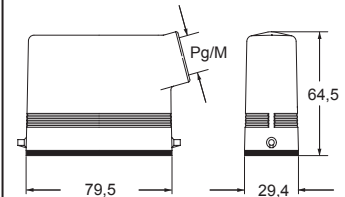

#### MZAOE L and MZAVE L

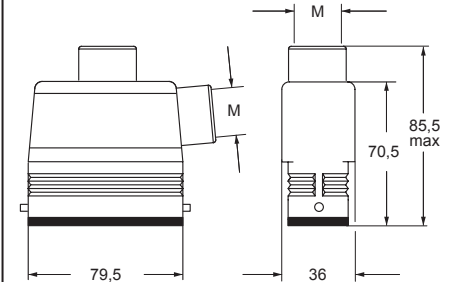

#### MZVE L

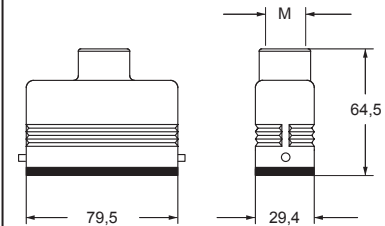

#### CZ7CE LG

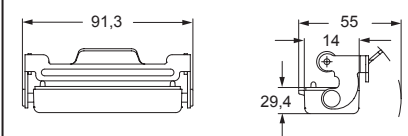

**CAUS** Type 4/4X/12



# CH and MA for aggressive environments E-Xtreme®

inserts		page:
CDD	24 poles + ⊕	76
CDS	9 poles + ⊕	-
CDSH	9 poles + ⊕	86
CDSH NC	6 poles + ⊕	95
CNE	6 poles + ⊕	110
CSE	6 poles + ⊕	-
CSH	6 poles + ⊕	110
CSH S	6 poles + ⊕	122
CCE	6 poles + ⊕	130
CSS	6 poles + ⊕	148
CT, CTSE (16A) *	6 poles + ⊕	160
CQE	10 poles + ⊕	168
MIXO	2 modules	232 - 287

\*) only for enclosure CHIE 06 L

## housings with single lever and cover

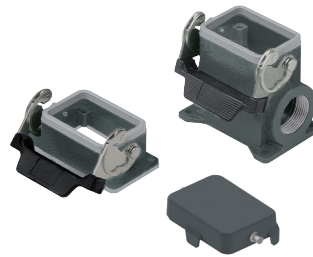

2.000 hrs

## hoods with riveted locking pegs and cover



2.000 hrs

description	part No.	part No	entry M	part No.	entry M
bulkhead mounting housing, with lever and gasket	<b>CHIE 06 L</b>				
surface mounting housing, with lever, high construction		<b>MAPE 06 L32</b>	32		
cover with pegs (for 1 lever enclosures) 1)	<b>CHCE 06 L</b>				
with pegs, side entry, high construction				<b>MAOE 06 L32</b>	32
with pegs, top entry, high construction				<b>MAVE 06 L32</b>	32
cover with lever (for enclosures with pegs) 2)				<b>CHCE 06 LG</b>	
with lever and gasket, top entry, high construction				<b>MAVE 06 LG32</b>	32

### TECHNICAL DETAILS:

- 2.000 hours in salt spray tests (EN ISO 9227)
- temperature limits: -40 °C ... +125 °C
- mechanical life: ≥ 500 cycles
- Alternatively, hoods with pegs are coupled with fixed enclosures:
- C7 E-Xtreme®, IP66/IP67 stainless steel lever, page 530

### CHIE L

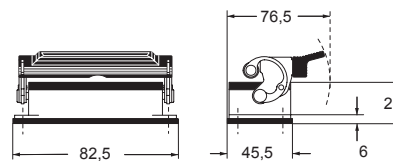

### panel cut-out for bulkhead mounting housings

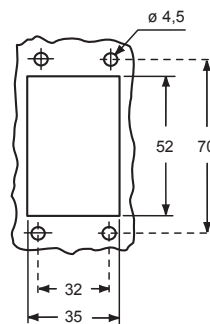

### MAPE L

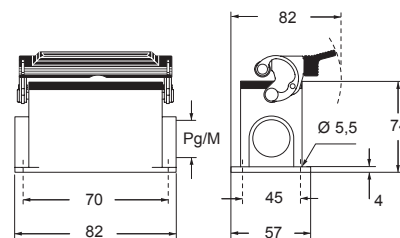

### CHCE L

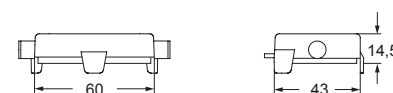

### MAOE L

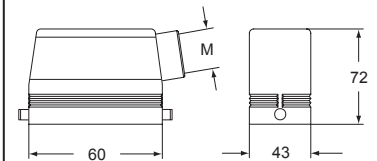

### MAVE L

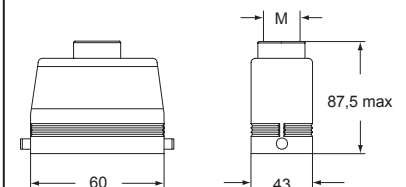

### CHCE LG

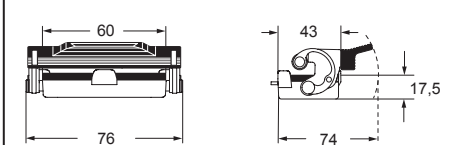

### MAVE LG

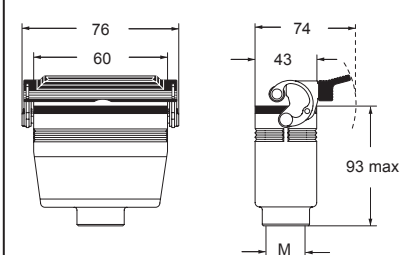

### For fixing on housings

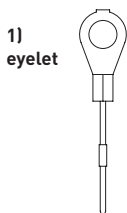

### For fixing on hoods

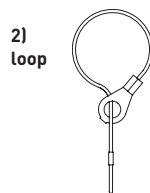

**CAUS** Type 4/4X/12

IP69 according to IEC/EN 60529



# CH and MA for aggressive environments E-Xtreme®

inserts		page:
CDD	42 poles + ⊕	78
CDS	18 poles + ⊕	-
CDSH	18 poles + ⊕	87
CNE	10 poles + ⊕	111
CSE	10 poles + ⊕	-
CSH	10 poles + ⊕	111
CSH S	10 poles + ⊕	123
CCE	10 poles + ⊕	131
CMSH	3+2 (aux) poles + ⊕	136
CMCE	3+2 (aux) poles + ⊕	137
CSS	10 poles + ⊕	149
CT, CTSE (16A) *)	10 poles + ⊕	161
CQE	18 poles + ⊕	169
CX	8/24 poles + ⊕	194
MIXO	3 modules	232 - 287

\*) only for enclosure CHIE 10

## housings with 2 levers and cover

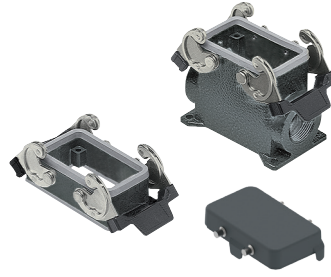

**2.000 hrs**

## hoods with riveted locking peg and cover



**2.000 hrs**

description	part No.	part No	entry M	part No.	entry M
bulkhead mounting housing, with levers and gasket	<b>CHIE 10</b>				
surface mounting housing, with levers, high construction		<b>MAPE 10.32</b>	32		
cover with 4 pegs (for enclosures with 2 levers) 1)	<b>CHCE 10</b>				
with pegs, side entry, high construction				<b>MAOE 10.32</b>	32
with pegs, top entry, high construction				<b>MAVE 10.32</b>	32
cover with 2 levers (for enclosures with 4 pegs) 2)				<b>CHCE 10 G</b>	
with levers and gasket, top entry, high construction				<b>MAVE 10 G32</b>	32

### TECHNICAL DETAILS:

- 2.000 hours in salt spray tests (EN ISO 9227)
  - temperature limits: -40 °C ... +125 °C
  - mechanical life: ≥ 500 cycles
- Alternatively, hoods with pegs are coupled with fixed enclosures:  
 - C7 E-Xtreme®, IP66/IP67 stainless steel lever, page 532

### CHIE

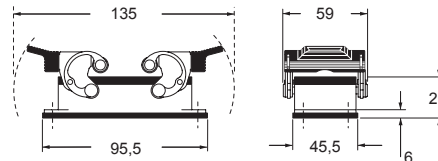

panel cut-out for bulkhead mounting housings

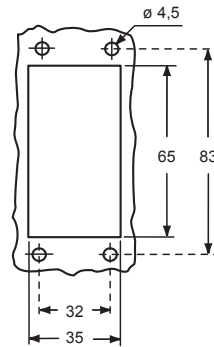

### MAPE

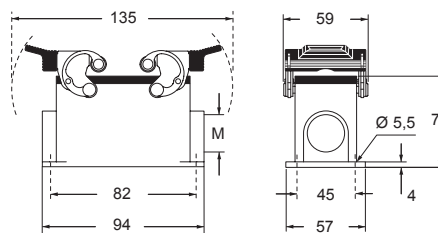

### CHCE



### MAOE

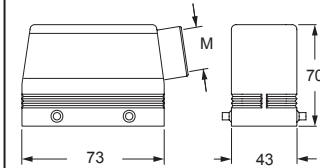

### MAVE

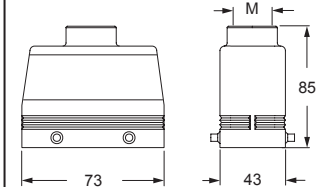

### CHCE G

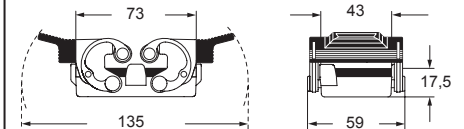

### MAVE G

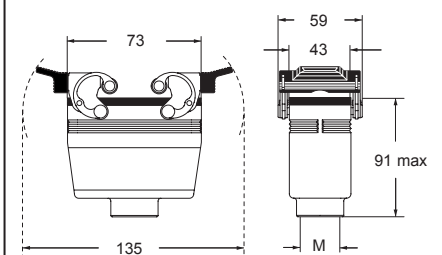

### For fixing on housings

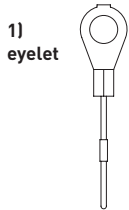

### For fixing on hoods

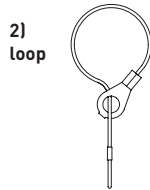

**CUUS** Type 4/4X/12

IP69 according to IEC/EN 60529

# CH and MH - MA for aggressive environments E-Xtreme®

inserts		page:
CD	40 poles + ⊕	70
CDD	72 poles + ⊕	79
CDS	27 poles + ⊕	-
CDSH	27 poles + ⊕	88
CNE	16 poles + ⊕	112
CSE	16 poles + ⊕	-
CSH	16 poles + ⊕	112
CSH S	16 poles + ⊕	124
CCE	16 poles + ⊕	132
CMSH, CMCE	6+2 (aux) poles + ⊕	138 - 139
CSS	16 poles + ⊕	150
CT, CTS (10A) *)	40 poles + ⊕	156
CT, CTSE (16A) *)	16 poles + ⊕	162
CQE	32 poles + ⊕	170
CQEE	40 poles + ⊕	176
CP	6 poles + ⊕	178
CX	6/12, 6/36 and 12/2 poles + ⊕	197 - 199
CX	4/0 and 4/2 poles + ⊕	200 - 201
MIXO	4 modules	232 - 287

\*) only for enclosure CHIE 16

## housings with 2 levers and cover

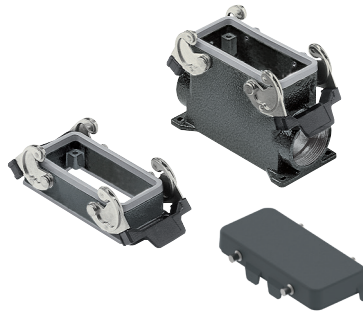

2.000 hrs

## hoods with riveted locking pegs and cover



2.000 hrs

description	part No.	part No	entry M	part No.	entry M
bulkhead mounting housing, with levers and gasket	<b>CHIE 16</b>				
surface mounting housing, with levers, high construction		<b>MAPE 16.32</b>	32		
cover with 4 pegs (for enclosures with 2 levers) 1)	<b>CHCE 16</b>				
with pegs, side entry				<b>MHOE 16.25</b>	25
with pegs, side entry				<b>MHOE 16.32</b>	32
with pegs, side entry, high construction				<b>MAOE 16.32</b>	32
with pegs, side entry, high construction				<b>MAOE 16.40</b>	40
with pegs, top entry				<b>MHVE 16.25</b>	25
with pegs, top entry				<b>MHVE 16.32</b>	32
with pegs, top entry, high construction				<b>MAVE 16.32</b>	32
with pegs, top entry, high construction				<b>MAVE 16.40</b>	40
cover with 2 levers (for enclosures with 4 pegs 2)				<b>CHCE 16 G</b>	
with levers and gasket, top entry, high construction				<b>MAVE 16 G32</b>	32

### TECHNICAL DETAILS:

- 2.000 hours in salt spray tests (EN ISO 9227)
- temperature limits: -40 °C ... +125 °C
- mechanical life: ≥ 500 cycles
- Alternatively, hoods with pegs are coupled with fixed enclosures:
- C7 E-Xtreme®, IP66/IP67 stainless steel lever, page 534

### For fixing on housings

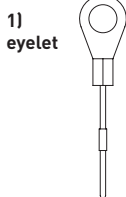

### For fixing on hoods

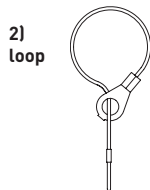

### CHIE

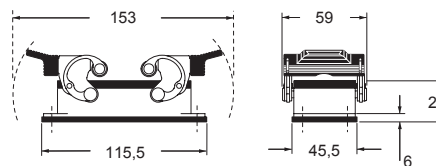

### panel cut-out for bulkhead mounting housings

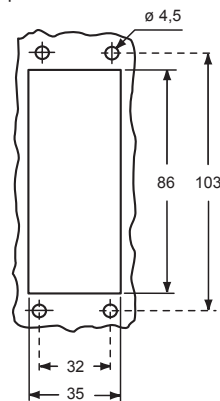

### MAPE

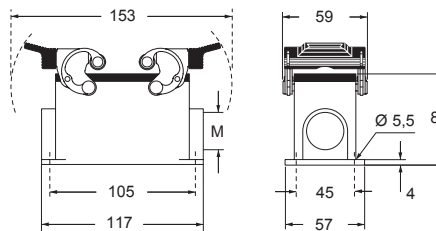

### CHCE

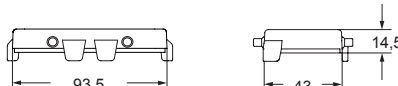

### MHOE (MAOE)

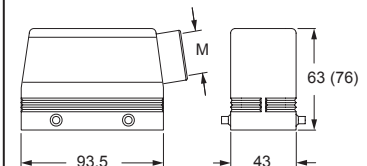

### MHVE (MAVE)

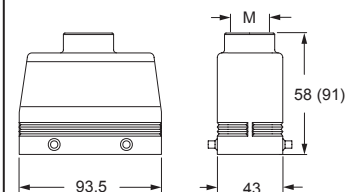

### CHCE G

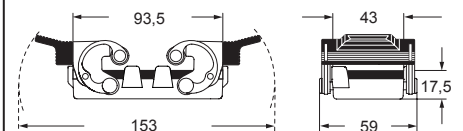

### MAVE G

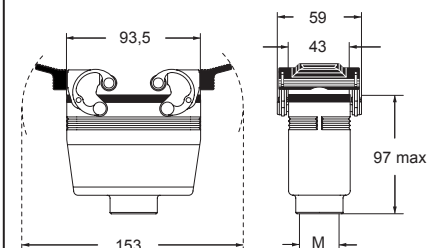

**CAUS** Type 4/4X/12

IP66 according to IEC/EN 60529

E-Xtreme®

# CH and MH - MA for aggressive environments E-Xtreme®

inserts		page:
CD	64 poles + ⊕	72
CDD	108 poles + ⊕	81
CDS	42 poles + ⊕	-
CDSH	42 poles + ⊕	89
CNE	24 poles + ⊕	113
CSE	24 poles + ⊕	-
CSH	24 poles + ⊕	113
CSH S	24 poles + ⊕	125
CCE	24 poles + ⊕	133
CMSH	10+2 (aux) poles + ⊕	140
CMCE	10+2 (aux) poles + ⊕	141
CSS	24 poles + ⊕	151
CT, CTS (10A *)	64 poles + ⊕	157
CT, CTSE (16A *)	24 poles + ⊕	163
CQE	46 poles + ⊕	171
CQEE	64 poles + ⊕	177
CX	4/8 and 6/6 poles + ⊕	204 and 206
MIXO	6 modules	232 - 287

\*) only for enclosure CHIE 24

## housings with 2 levers and cover

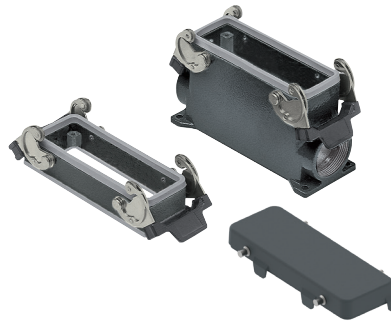

2.000 hrs

## hoods with riveted locking pegs and cover



2.000 hrs

description	part No.	part No	entry M	part No.	entry M
bulkhead mounting housing, with levers and gasket	<b>CHIE 24</b>				
surface mounting housing, with levers, high construction		<b>MAPE 24.32</b>	32		
cover with 4 pegs (for enclosures with 2 levers) 1)	<b>CHCE 24</b>				
with pegs, side entry				<b>MHOE 24.25</b>	25
with pegs, side entry				<b>MHOE 24.32</b>	32
with pegs, side entry, high construction				<b>MAOE 24.32</b>	32
with pegs, side entry, high construction				<b>MAOE 24.40</b>	40
with pegs, top entry				<b>MHVE 24.25</b>	25
with pegs, top entry				<b>MHVE 24.32</b>	32
with pegs, top entry, high construction				<b>MAVE 24.32</b>	32
with pegs, top entry, high construction				<b>MAVE 24.40</b>	40
cover with 2 levers (for enclosures with 4 pegs) 2)	<b>CHCE 24 G</b>				
with levers and gasket, top entry, high construction				<b>MAVE 24 G32</b>	32

### TECHNICAL DETAILS:

- 2.000 hours in salt spray tests (EN ISO 9227)
- temperature limits: -40 °C ... +125 °C
- mechanical life: ≥ 500 cycles
- Alternatively, hoods with pegs are coupled with fixed enclosures:
- C7 E-Xtreme®, IP66/IP67 stainless steel lever, page 536

### For fixing on housings

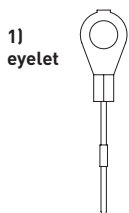

### For fixing on hoods

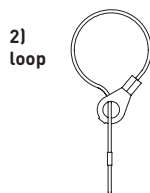

### CHIE

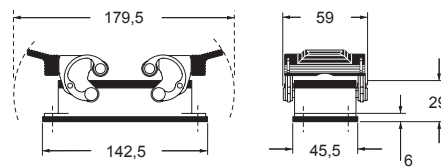

panel cut-out for bulkhead mounting housings

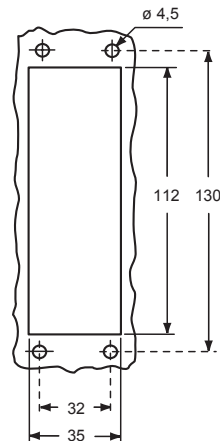

### MAPE

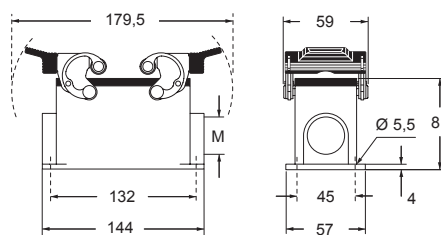

### CHCE

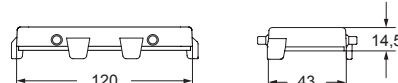

### MHOE (MAOE)

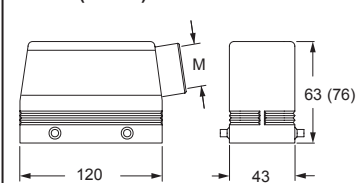

### MHVE (MAVE)

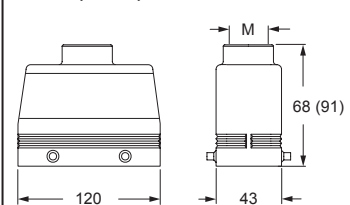

### CHCE G

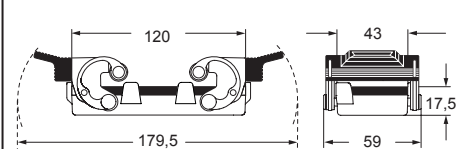

### MAVE G

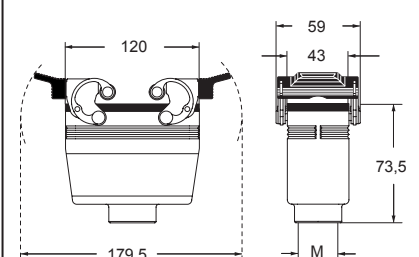

**CAUS** Type 4/4X/12



IP69 according to IEC/EN 60529

inserts		page:
CD	80 poles + ⊕	73
CDD	144 poles + ⊕	82
CDS	54 poles + ⊕	-
CDSH	54 poles + ⊕	90
CNE	32 poles + ⊕	114
CSE	32 poles + ⊕	-
CSH	32 poles + ⊕	114
CSH S	32 poles + ⊕	126
CCE	32 poles + ⊕	134
CSS	32 poles + ⊕	152
CTSE (16A) *	32 poles + ⊕	164
CQE	64 poles + ⊕	172
CME	12+4 (aux) poles + ⊕	142
CMSH	12+4 (aux) poles + ⊕	142
CMCE	12+4 (aux) poles + ⊕	143
CP	12 poles + ⊕	179
MIXO	4 + 4 modules	232 - 287

\*) only for enclosure CHIE 32

insert dimensions:  
2 x (77,5 x 27) mm

housings with 2 levers and cover

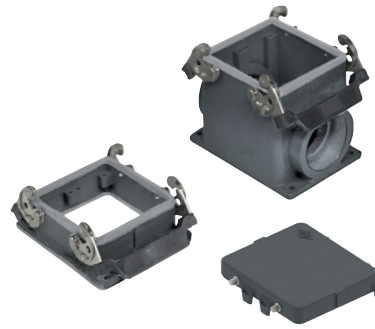

2.000 hrs

hoods with riveted locking pegs and cover



2.000 hrs

description	part No.	part No	entry M	part No.	entry M
bulkhead mounting housing, with levers and gasket	CHIE 32				
surface mounting housing, with levers, high construction		MHPE 32.50	50		
cover with 4 pegs (for enclosures with 2 levers) 1)	CHCE 32				
with pegs, side entry				MHOE 32.40	40
with pegs, top entry				MHVE 32.40	40
cover with 2 levers (for enclosures with 4 pegs) 2)				CHCE 32 G	
with levers and gasket, top entry				MHVE 32 G40	40

TECHNICAL DETAILS:

- 2.000 hours in salt spray tests (EN ISO 9227)
- temperature limits: -40 °C ... +125 °C
- mechanical life: ≥ 500 cycles

CHIE

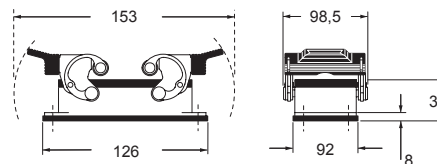

panel cut-out for bulkhead mounting housings

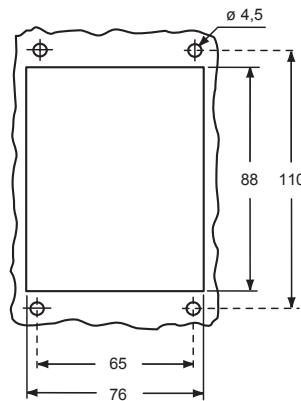

MHPE

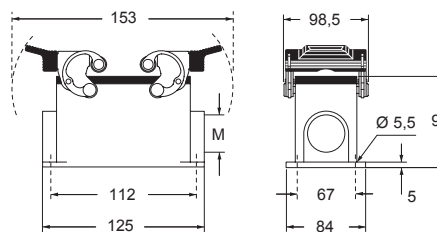

CHCE



MHOE

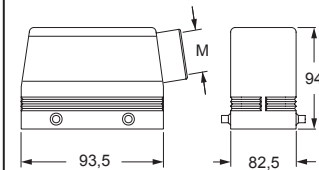

MHVE

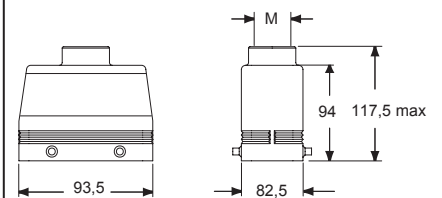

CHCE G

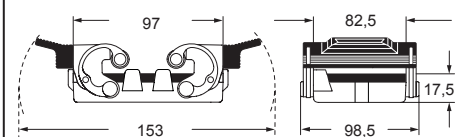

MHVE G

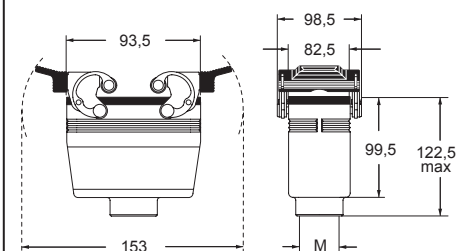

For fixing on housings

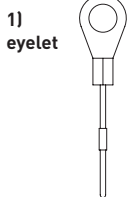

For fixing on hoods

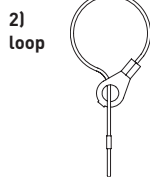

CAIUS® Type 4/4X/12



IP69 according to IEC/EN 60529

# CH and MH for aggressive environments E-Xtreme®

inserts		page:
CD	128 poles + ⊕	74
CDD	216 poles + ⊕	83
CDS	84 poles + ⊕	-
CDSH	84 poles + ⊕	91
CNE	48 poles + ⊕	115
CSE	48 poles + ⊕	-
CSH	48 poles + ⊕	115
CSH S	48 poles + ⊕	127
CCE	48 poles + ⊕	135
CME	20+4 (aux) poles + ⊕	144
CMSH	20+4 (aux) poles + ⊕	144
CSS	48 poles + ⊕	153
CTSE (16A) *)	48 poles + ⊕	165
CQE	92 poles + ⊕	173
MIXO	6 + 6 modules	232 - 287

\*) only for enclosure CHIE 48 LS

insert dimensions:  
2 x (104 x 27) mm

description	part No.	part No	entry M	part No.	entry M
bulkhead mounting housings, with lever, gasket and cover	<b>CHIE 48 LS</b>	<b>MHPE 48 LS40</b>	40 x 2	<b>MHOE 48 L40</b>	40
surface mounting housings, with lever and cover				<b>MHVE 48 L40</b>	40
with pegs, side entry					
with pegs, top entry					

**TECHNICAL DETAILS:**

- 2.000 hours in salt spray tests (EN ISO 9227)
- temperature limits: -40 °C ... +125 °C
- mechanical life: ≥ 500 cycles

**housings with single lever**



**2.000 hrs**

**hoods with riveted locking pegs**



**2.000 hrs**

**CHIE LS**

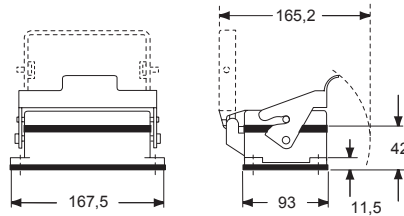

panel cut-out for bulkhead mounting housings

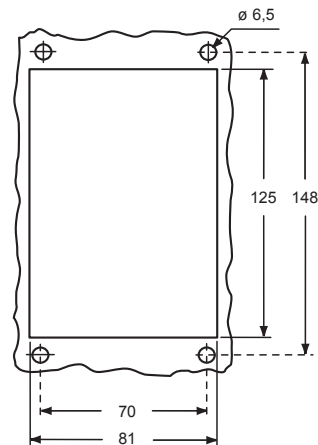

**MHPE LS**

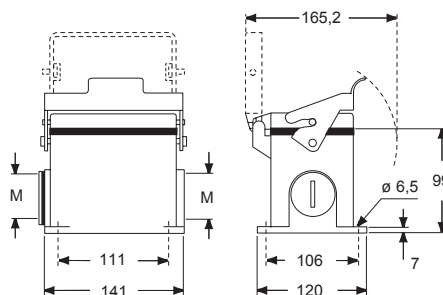

**MHOE L**

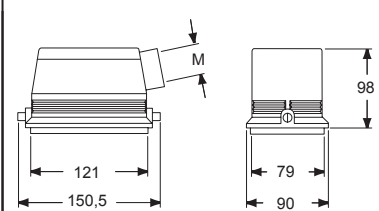

**MHVE L**

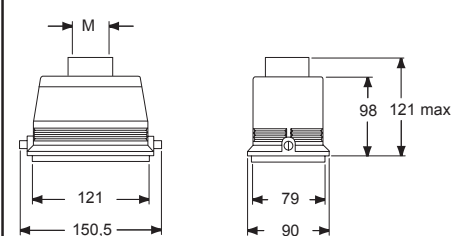

**CALUS**® Type 4/4X/12



IP69 according to IEC/EN 60529

inserts		page:
CD	50 poles + ⊕	71
CDD	76 poles + ⊕	80
CDA	32 poles + ⊕	102
CSAH	32 poles + ⊕	103
CDC	32 poles + ⊕	106

insert dimensions:  
2 x (66 x 16) mm

housings with 2 levers and cover

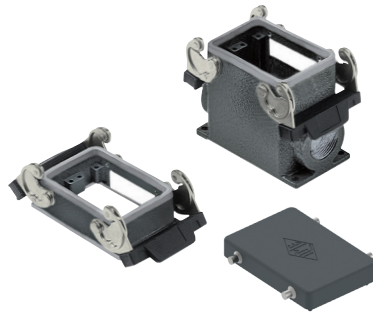

2.000 hrs

hoods with riveted locking pegs and cover

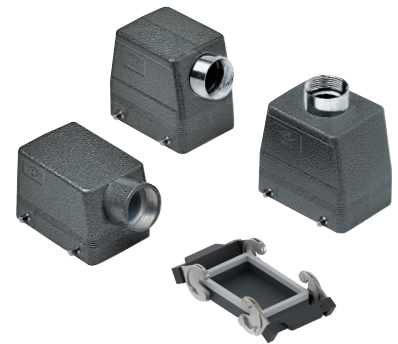

2.000 hrs

description	part No.	part No	entry M	part No.	entry M
bulkhead mounting housings, with levers and gasket	<b>CHIE 50</b>				
bulkhead mounting housings, with levers		<b>MHPE 50.32</b>	32		
surface mounting housing, with levers		<b>MHPE 50.240</b>	40 x 2		
cover with 4 pegs (for housings with 2 levers) 1)	<b>CHCE 50</b>				
with pegs, side entry				<b>MHOE 50.25</b>	25
with pegs, side entry				<b>MHOE 50.32</b>	32
with pegs, side entry, high construction				<b>MAOE 50.320</b>	32
with pegs, top entry, high construction				<b>MAVE 50.32</b>	32
cover with 2 levers (for enclosures with 4 pegs) 2)				<b>CHCE 50 G</b>	

**TECHNICAL DETAILS:**

- 2.000 hours in salt spray tests (EN ISO 9227)
- temperature limits: -40 °C ... +125 °C
- mechanical life: ≥ 500 cycles

**CHIE**

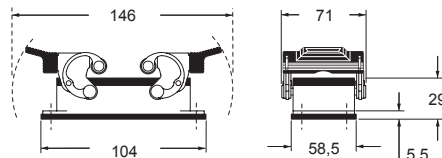

panel cut-out for bulkhead mounting housings

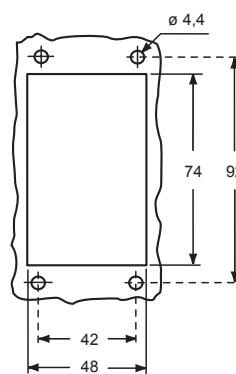

**MHPE**

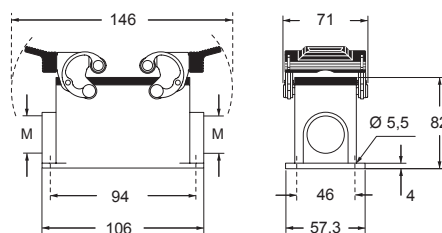

**MHPE**



**MHOE (MAOE)**

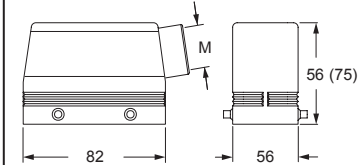

**MAVE**

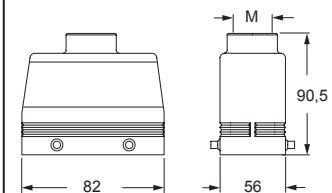

**CHCE G**

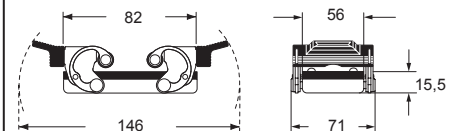

For fixing on housings

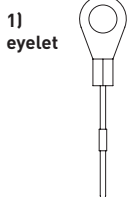

For fixing on hoods

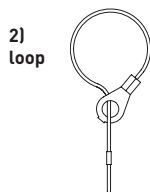

**CAVUS** Type 4/4X/12

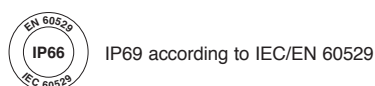





**CG and MG high protection IP68 version E-Xtreme®**

inserts		page:
CDD	24 poles + ⊕	76
CDS	9 poles + ⊕	-
CDSH	9 poles + ⊕	86
CDSH NC	6 poles + ⊕	95
CNE	6 poles + ⊕	110
CSE	6 poles + ⊕	-
CSH	6 poles + ⊕	110
CSH S	6 poles + ⊕	122
CCE	6 poles + ⊕	130
CSS	6 poles + ⊕	148
CQE	10 poles + ⊕	168
MIXO	2 modules	232 - 287

**bulkhead mounting housings  
screw locking**



**3.000 hrs**

**surface mounting housings  
screw locking**



**3.000 hrs**

description	part No.	part No.	entry
with gasket, size "44.27"	<b>CGIE 06</b>	<b>MGPE 06.32</b>	<b>32</b>
size "44.27"			

**TECHNICAL DETAILS:**

- 3.000 hours in salt spray tests (EN ISO 9227)
- temperature limits: -40 °C ... +125 °C
- on request -60 °C ... +180 °C with silicone gasket (>125 °C up to 180 °C with RY inserts)

**CGIE**

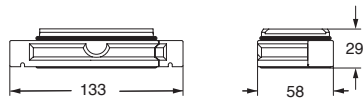

panel cut-out for bulkhead mounting housings

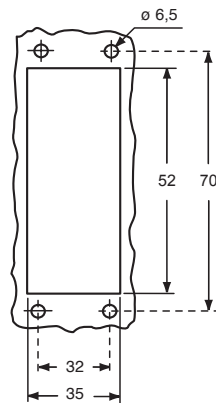

**MGPE**

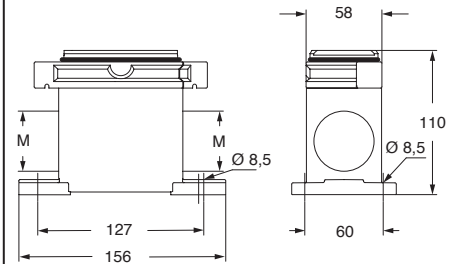

**Dust protection cover CGCP FX (from page 697)**



according to IEC/EN 60529

# CG and MG high protection IP68 version E-Xtreme®

inserts		page:
CDD	24 poles + ⊕	76
CDS	9 poles + ⊕	-
CDSH	9 poles + ⊕	86
CDSH NC	6 poles + ⊕	95
CNE	6 poles + ⊕	110
CSE	6 poles + ⊕	-
CSH	6 poles + ⊕	110
CSH S	6 poles + ⊕	122
CCE	6 poles + ⊕	130
CSS	6 poles + ⊕	148
CQE	10 poles + ⊕	168
MIXO	2 modules	232 - 287

## hoods, screw locking



**3.000 hrs**

## covers, screw locking



**3.000 hrs**

description	part No.	entry M	part No.
with side entry size "44.27"	<b>MGOE 06.25</b>	25	
size "44.27"	<b>MGOE 06.32</b>	32	
with top entry size "44.27"	<b>MGVE 06.25</b>	25	
size "44.27"	<b>MGVE 06.32</b>	32	
size "44.27"	<b>MGVE 06.40</b>	40	
			<b>CGCE 06</b>

### TECHNICAL DETAILS:

- 3.000 hours in salt spray tests (EN ISO 9227)
- temperature limits: -40 °C ... +125 °C
- on request -60 °C ... +180 °C with silicone gasket (>125 °C up to 180 °C with RY inserts)

### MGOE and MGVE

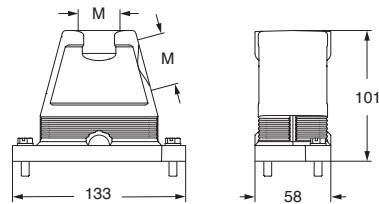

### CGCE

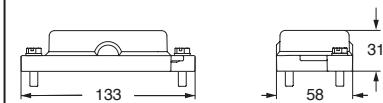

Dust protection cover CGCP MB (from page 697)



according to IEC/EN 60529

# CG and MG high protection IP68 version E-Xtreme®

inserts		page:
CDD	42 poles + ⊕	78
CDS	18 poles + ⊕	-
CDSH	18 poles + ⊕	87
CNE	10 poles + ⊕	111
CSE	10 poles + ⊕	-
CSH	10 poles + ⊕	111
CSH S	10 poles + ⊕	123
CCE	10 poles + ⊕	131
CMSH	3+2 (aux) poles + ⊕	136
CMCE	3+2 (aux) poles + ⊕	137
CSS	10 poles + ⊕	149
CQE	18 poles + ⊕	169
CX	8/24 poles + ⊕	194
MIXO	3 modules	232 - 287

## bulkhead mounting housings screw locking



3.000 hrs

## surface mounting housings screw locking

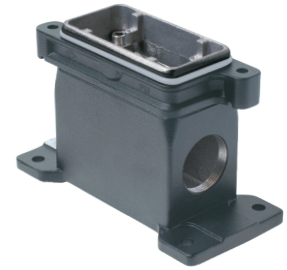

3.000 hrs

description	part No.	part No.	entry
with gasket, size "57.27"	CGIE 10	MGPE 10.32	32
size "57.27"			M

with gasket, size "57.27"  
size "57.27"

CGIE 10

MGPE 10.32 32

### TECHNICAL DETAILS:

- 3.000 hours in salt spray tests (EN ISO 9227)
- temperature limits: -40 °C ... +125 °C
- on request -60 °C ... +180 °C with silicone gasket (>125 °C up to 180 °C with RY inserts)

### CGIE

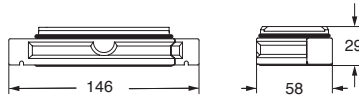

panel cut-out for bulkhead mounting housings

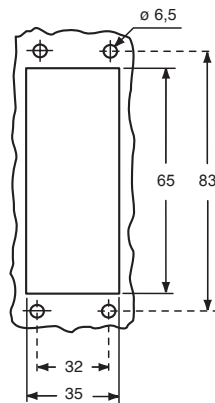

### MGPE

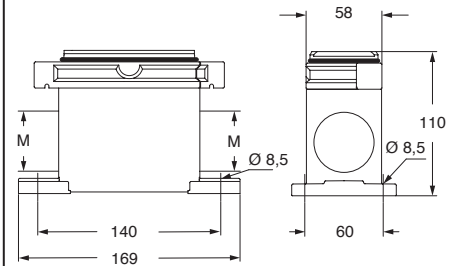

Dust protection cover CGCP FX (from page 697)



according to IEC/EN 60529

E-Xtreme®

# CG and MG high protection IP68 version E-Xtreme®

inserts		page:
CDD	42 poles + ⊕	78
CDS	18 poles + ⊕	-
CDSH	18 poles + ⊕	87
CNE	10 poles + ⊕	111
CSE	10 poles + ⊕	-
CSH	10 poles + ⊕	111
CSH S	10 poles + ⊕	123
CCE	10 poles + ⊕	131
CMSH	3+2 (aux) poles + ⊕	136
CMCE	3+2 (aux) poles + ⊕	137
CSS	10 poles + ⊕	149
CQE	18 poles + ⊕	169
CX	8/24 poles + ⊕	194
MIXO	3 modules	232 - 287

## hoods, screw locking



**3.000 hrs**

## covers, screw locking



**3.000 hrs**

description	part No.	entry M	part No.
with side entry size "57.27"	<b>MGOE 10.25</b>	25	
size "57.27"	<b>MGOE 10.32</b>	32	
with top entry size "57.27"	<b>MGVE 10.25</b>	25	
size "57.27"	<b>MGVE 10.32</b>	32	
size "57.27"	<b>MGVE 10.40</b>	40	
			<b>CGCE 10</b>

### TECHNICAL DETAILS:

- 3.000 hours in salt spray tests (EN ISO 9227)
- temperature limits: -40 °C ... +125 °C
- on request -60 °C ... +180 °C with silicone gasket (>125 °C up to 180 °C with RY inserts)

### MGOE and MGVE

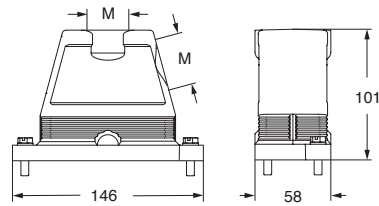

### CGCE

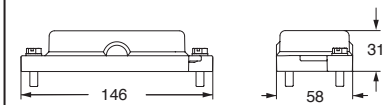

Dust protection cover CGCP MB (from page 697)



according to IEC/EN 60529

# CG and MG high protection IP68 version E-Xtreme®

inserts		page:
CD	40 poles + ⊕	70
CDD	72 poles + ⊕	79
CDS	27 poles + ⊕	-
CDSH	27 poles + ⊕	88
CNE	16 poles + ⊕	112
CSE	16 poles + ⊕	-
CSH	16 poles + ⊕	112
CSH S	16 poles + ⊕	124
CCE	16 poles + ⊕	132
CMSH, CMCE	6+2 (aux) poles + ⊕	138 - 139
CSS	16 poles + ⊕	150
CQE	32 poles + ⊕	170
CQEE	40 poles + ⊕	176
CP	6 poles + ⊕	178
CX	6/12, 6/36 and 12/2 poles + ⊕	197 - 199
CX	4/0 and 4/2 poles + ⊕	200 - 201
MIXO	4 modules	232 - 287

## bulkhead mounting housings screw locking



3.000 hrs

## surface mounting housings screw locking



3.000 hrs

description	part No.	part No.	entry
with gasket, size "77.27"	CGIE 16		M
size "77.27"		MGPE 16.40	40

### TECHNICAL DETAILS:

- 3.000 hours in salt spray tests (EN ISO 9227)
- temperature limits: -40 °C ... +125 °C
- on request -60 °C ... +180 °C with silicone gasket (>125 °C up to 180 °C with RY inserts)

### CGIE

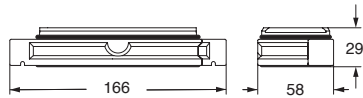

panel cut-out for bulkhead mounting housings

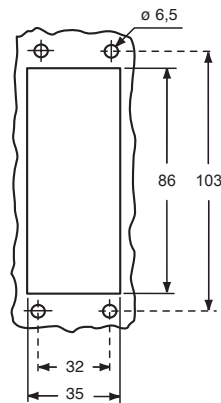

### MGPE

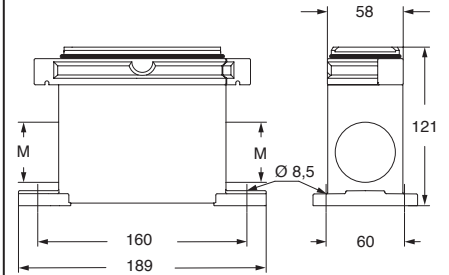

Dust protection cover CGCP FX (from page 697)



according to IEC/EN 60529

E-Xtreme®



# CG and MG high protection IP68 version E-Xtreme®

inserts		page:
CD	40 poles + ⊕	70
CDD	72 poles + ⊕	79
CDS	27 poles + ⊕	-
CDSH	27 poles + ⊕	88
CNE	16 poles + ⊕	112
CSE	16 poles + ⊕	-
CSH	16 poles + ⊕	112
CSH S	16 poles + ⊕	124
CCE	16 poles + ⊕	132
CMSH, CMCE	6+2 (aux) poles + ⊕	138 - 139
CSS	16 poles + ⊕	150
CQE	32 poles + ⊕	170
CQEE	40 poles + ⊕	176
CP	6 poles + ⊕	178
CX	6/12, 6/36 and 12/2 poles + ⊕	197 - 199
CX	4/0 and 4/2 poles + ⊕	200 - 201
MIXO	4 modules	232 - 287

## hoods, screw locking



**3.000 hrs**

## covers, screw locking



**3.000 hrs**

description	part No.	entry M	part No.
with side entry			
size "77.27"	<b>MGOE 16.32</b>	32	
size "77.27"	<b>MGOE 16.40</b>	40	
size "77.27"	<b>MGOE 16.50</b>	50	
with top entry			
size "77.27"	<b>MGVE 16.25</b>	25	
size "77.27"	<b>MGVE 16.225</b>	25 x 2	
size "77.27"	<b>MGVE 16.32</b>	32	
size "77.27"	<b>MGVE 16.40</b>	40	
size "77.27"	<b>MGVE 16.50</b>	50	
size "77.27"			<b>CGCE 16</b>

### TECHNICAL DETAILS:

- 3.000 hours in salt spray tests (EN ISO 9227)
- temperature limits: -40 °C ... +125 °C  
on request -60 °C ... +180 °C with silicone gasket  
(>125 °C up to 180 °C with RY inserts)

### MGOE and MGVE

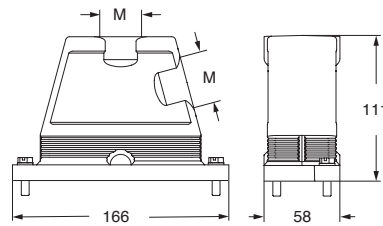

### CGCE

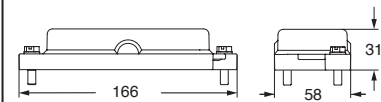

Dust protection cover CGCP MB (from page 697)



according to IEC/EN 60529

**CG and MG high protection IP68 version E-Xtreme®**

inserts		page:
CD	64 poles + ⊕	72
CDD	108 poles + ⊕	81
CDS	42 poles + ⊕	-
CDSH	42 poles + ⊕	89
CNE	24 poles + ⊕	113
CSE	24 poles + ⊕	-
CSH	24 poles + ⊕	113
CSH S	24 poles + ⊕	125
CCE	24 poles + ⊕	133
CMSH	10+2 (aux) poles + ⊕	140
CMCE	10+2 (aux) poles + ⊕	141
CSS	24 poles + ⊕	151
CQE	46 poles + ⊕	171
CQEE	64 poles + ⊕	177
CX	4/8 and 6/6 poles + ⊕	204 and 206
MIXO	6 modules	232 - 287

**bulkhead mounting housings  
screw locking**



**3.000 hrs**

**surface mounting housings  
screw locking**



**3.000 hrs**

description	part No.	part No.	entry
with gasket, size "104.27"	<b>CGIE 24</b>		
size "104.27"		<b>MGPE 24.40</b>	40
size "104.27"		<b>MGPE 24.240</b>	40 x 2

**TECHNICAL DETAILS:**

- 3.000 hours in salt spray tests (EN ISO 9227)
- temperature limits: -40 °C ... +125 °C
- on request -60 °C ... +180 °C with silicone gasket
- (>125 °C up to 180 °C with RY inserts)

**CGIE**

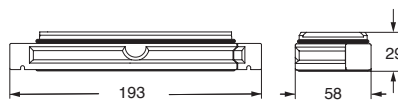

panel cut-out for bulkhead mounting housings

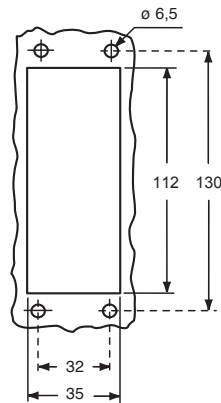

**MGPE**

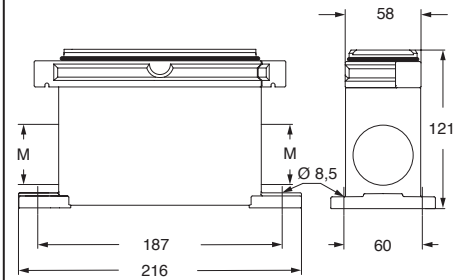

**Dust protection cover CGCP FX (from page 697)**



according to IEC/EN 60529

E-Xtreme®

# CG and MG high protection IP68 version E-Xtreme®

inserts		page:
CD	64 poles + ⊕	72
CDD	108 poles + ⊕	81
CDS	42 poles + ⊕	-
CDSH	42 poles + ⊕	89
CNE	24 poles + ⊕	113
CSE	24 poles + ⊕	-
CSH	24 poles + ⊕	113
CSH S	24 poles + ⊕	125
CCE	24 poles + ⊕	133
CMSH	10+2 (aux) poles + ⊕	140
CMCE	10+2 (aux) poles + ⊕	141
CSS	24 poles + ⊕	151
CQE	46 poles + ⊕	171
CQEE	64 poles + ⊕	177
CX	4/8 and 6/6 poles + ⊕	204 and 206
MIXO	6 modules	232 - 287

## hoods, screw locking



**3.000 hrs**

## covers, screw locking



**3.000 hrs**

description	part No.	entry M	part No.
with side entry			
size "104.27"	<b>MGOE 24.32</b>	32	
size "104.27"	<b>MGOE 24.40</b>	40	
size "104.27"	<b>MGOE 24.50</b>	50	
with top entry			
size "104.27"	<b>MGVE 24.325</b>	25 x 3	
size "104.27"	<b>MGVE 24.32</b>	32	
size "104.27"	<b>MGVE 24.232</b>	32 x 2	
size "104.27"	<b>MGVE 24.40</b>	40	
size "104.27"	<b>MGVE 24.240</b>	40 x 2	
size "104.27"	<b>MGVE 24.50</b>	50	
size "104.27"			<b>CGCE 24</b>

### TECHNICAL DETAILS:

- 3.000 hours in salt spray tests (EN ISO 9227)
- temperature limits: -40 °C ... +125 °C
- on request -60 °C ... +180 °C with silicone gasket (>125 °C up to 180 °C with RY inserts)

### MGOE and MGVE

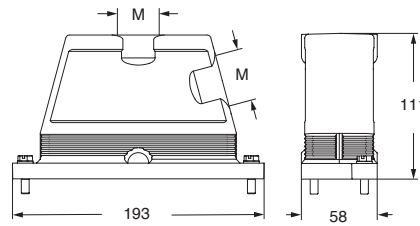

### CGCE

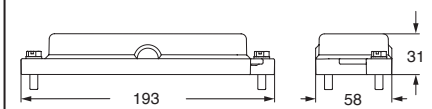

Dust protection cover CGCP MB (from page 697)



according to IEC/EN 60529

## EMC

### Directives and standards

The concept of **Electromagnetic Compatibility (EMC)** is the reversal in the positive sense of what was until recently known as **Electromagnetic Interference (EMI)**: **we have electromagnetic compatibility** between a device and the environment (including surrounding equipment) when there is no reciprocal electromagnetic interference or when this is within tolerable limits.

In other words, **to obtain electromagnetic compatibility**, measures must be adopted aimed at bringing the electrical or electronic equipment to levels of **emission** and electromagnetic **immunity** against electromagnetic interference such that it continues to function properly without causing disturbance to other equipment present in the surrounding environment.

In the electrical equipment of industrial machines, rectangular multipole connectors with their metallic enclosures are widely used due to their high standards of safety, reliability, mechanical robustness and resistance to corrosion and pollution.

These connectors are passive electromechanical components: they do not generate electromagnetic interference and are not disturbed in their function. Taken by themselves, therefore, they fall outside the scope of Directive 2014/30/EU on electromagnetic compatibility and the CE marking is therefore not required for EMC aspects: it still applies, however, under the Low Voltage Directive 2014/30/EU.

It is rather the devices and industrial equipment mentioned above, in which the connectors are for the most part used (e.g. on-board electric panels) which, taken as a whole, must be CE marked also for EMC aspects, having to meet the essential requirements of the EMC Directive.

For the EMC in **industrial environments** two European standards are in force, not intended for specific equipment, which regulate the **emissions** and **immunity** of devices.

These are therefore generic standards, one for **emissions EN 61000-6-4:2007 + A1:2011** (class. CEI 210-66:2007 + 210-66;V1:2011, equivalent to IEC 61000-4:2006 + A1:2010) and one for **immunity EN 61000-6-2:2005** (class. CEI 210-54:2006, equivalent to IEC 61000-6-2:2005)<sup>1)</sup>.

These apply in the absence of provisions in the particular EMC product standards or in the total absence of the latter.

For industrial equipment, when appliances are not intentionally designed to generate radio frequencies<sup>2)</sup>, the latter case applies (no particular standards). In the European standards for switchgear and controlgear (EN 60947-1) and in those for the electrical equipment of machines EN 60204-1 emission and immunity limits have been for some time in the process of being issued, as well as their verification, if necessary, with reference to above mentioned EMC standards for industrial environment.

EMC testing should not be performed on individual components, but rather on the entire apparatus, sometimes not without inconsiderable logistical difficulties, due to their size, reproducing as far as possible their operation in real operating conditions.

It is therefore incorrect to assign limits of electromagnetic emission and immunity imposed on the equipment on, for example, electrical connectors used as components of the equipment.

<sup>1)</sup> There are two similar standards for the other standardized environment, defined as **residential, commercial and light industrial environment**, respectively **EN 61000-6-3:2007 + A1:2011** (class. CEI 210-65:2007 + CEI 210-61;V1:2011) for emissions (equivalent to IEC 61000-6-3:2006 + A1:2010) and **EN 61000-6-1:2007** (class. CEI 210-64:2007) for immunity (equivalent to IEC 61000-6-1:2006).

<sup>2)</sup> In which case for such devices, called **ISM (industrial, scientific, medical)** the – **EN 55011:2007** standard for emission of radio interference would apply.

# Electromagnetic interference and ILME connectors

Many years ago the entry into force of the first EMC European Directive, with requirement for electrical and electronic equipment to comply with the levels of electromagnetic pollution dictated by the standards, brought renewed interest in all the appropriate steps to mitigate the effects of electromagnetic interference.

Electromagnetic interference can occur in two forms: **conducted or radiated**. With reference to connectors, **conducted interference** transmitted on conductors wired to the connectors, is, for example: harmonics, superimposed on the voltage of the power supply at 50 Hz, caused by withdrawal of biased current or by electromechanical or electronic switches, or radio frequency interference noise which is inductively or capacitively coupled with the cable, overlapping transported signals.

This is characterized by frequency and amplitude (intensity) and can be filtered to some extent, in both in the outgoing (emission) and incoming (immunity) directions, only via in-line passive electrical filters, which the designer of the electrical equipment must foresee since he is the only one with a knowledge of all the terms of the problem <sup>3)</sup>.

**Radiated interference**, transmitted in the form of electromagnetic waves, is characterized by the values of amplitude of associated electric (V/m) and magnetic fields and with the frequency or frequency band (rarely is this located on a single frequency, more often it occupies a band). This may come from inside the device: in this case it is necessary to mitigate emissions. Or from the outside, in which case it is necessary to raise immunity.

By test convention, **interference with frequency up to 30 MHz** is considered to be conducted and **irradiated with frequency above 30 MHz up to 1 GHz**.

The sources of electromagnetic interference are classified as **intentional** and **unintentional**.

The first (e.g. radio-telecommunication antennas, mobile phones) use high frequency electromagnetic fields for functional reasons. For the second (e.g. ignition of internal combustion engines, electric arc furnaces) they are a by-product.

In most industrial applications, compared to the overall EMC issues of a device, connectors (inserts + enclosures), taken by themselves, are not the priority concern of the designer.

The enclosures of the low-frequency industrial connectors, taking shape as a barrier to a "shell", are implicitly a "peripheral" aspect: the designer of electrical equipment / electronics will take care first of all the "core" of the EMC problem, that of the active components inside of their systems, by limiting the emissions and enhance immunity.

In fact, to have significant problems due to radiation through the opening constituted by a connector enclosure on a control panel, there must be a particularly "efficient" radiofrequency source inside the panel.

Essentially, significant design errors must have been committed regarding the EMC of the entire equipment.

In certain cases the coupling of connectors may constitute the weak link in the chain, for example where it is not possible for functional reasons to further reduce interference of the electronics inside the control panel. In these cases one must rely on the efficiency of the shield. Even if the equipment manufacturer uses shielded fabrication and high quality shielded cables, continuity and homogeneity of such shielding could be significantly degraded precisely in the passage between free connector and panel.

In dealing with electromagnetic compatibility of electrical equipment of an industrial machine, a second aspect to be addressed as a priority is the presence of large quantities of interface cabling.

In these cases, the significant attenuation of the shield necessary for the cables must not be jeopardised by the connector enclosures due to imperfect earthing of the cable shield.

It should nevertheless be pointed out that increasing shielding may not be sufficient to solve possible problems and should be considered as a complementary choice.

<sup>3)</sup> For example, for trapezoidal D-Sub type connectors for digital data transmission, there are connectors on the market which incorporate "general purpose" filters for any conducted interference.

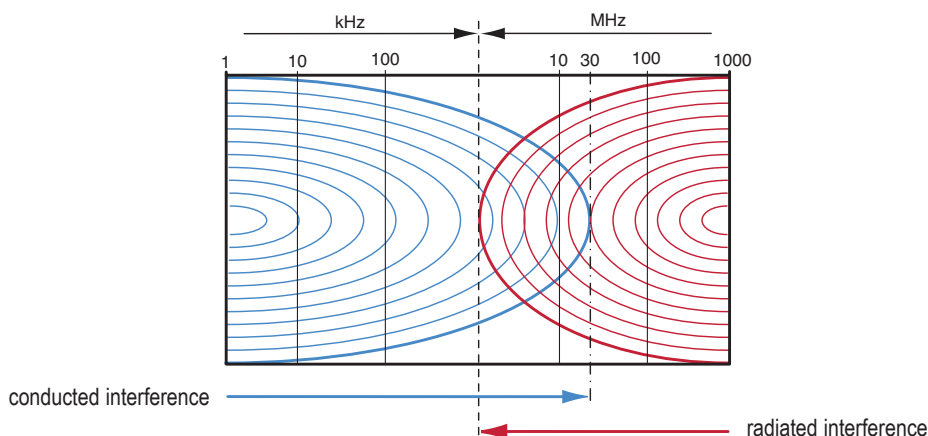

## Electromagnetic shielding of connectors: fundamental principles

To consider the electromagnetic compatibility aspects of an electrical/electronic device in the final verification rather than in the design phase almost always leads to a substantial increase in overall development time and costs.

The designer who deals with electromagnetic compatibility issues should use the same rules and the same precautions regardless of whether the equipment is subsequently shielded.

Numerous products meet electromagnetic compatibility standards without the use of shielding. However, when all other limiting interventions are impossible or uneconomical, recourse to increased efficiency of the electromagnetic shield is the only answer.

An **electromagnetic shield** is a barrier to the transmission of electromagnetic fields.

To generalise the concept to include conducted emissions, a filter can be considered as a shield. We will restrict ourselves here to considering a shield as a barrier to radiated emissions.

The metallic containers which completely enclose an electrical/electronic device or a part thereof **constitute an electromagnetic shield**, with the task of preventing the emissions of electrical/electronic devices or a part thereof to radiate outside the equipment container itself.

A cable connected to a device is part of the same for the purposes of electromagnetic compatibility.

A flexible multicore cable is shielded by surrounding the insulated conductors with a conductive metal mesh.

An electromagnetic shield is characterized by a parameter which measures its efficiency.

**The shielding attenuation** is the ratio between the radiated power generated inside a device and the residual radiated power outside the unit. The attenuation introduced by a shield can be measured by comparing the absence and presence of the shield.

**Shielding attenuation is measured** in dB (decibel). 20 dB is equivalent to an order of magnitude, i.e. attenuation of a factor of 10, 40 dB = attenuation of a factor of 100, etc.

To obtain large shielding attenuation values (e.g. 100 dB) the shield must completely enclose the electronic device and not have any means of access from the outside, such as openings, joints, cracks or cables. Any means of access through a shield, if not properly treated, can drastically reduce the efficiency of the shield.

### EMC connector enclosures and accessories

In light of the foregoing, ILME has developed for the designers of the electrical/electronic equipment of machines the new series of EMC connector enclosures and accessories.

Available as bulkhead mounting housings and hood versions in the various sizes 44.27, 57.27, 77.27 and 104.27, they maintain the robustness and reliability of standard types whilst possessing increased high frequency shielding characteristics.

In the development of EMC enclosures recourse to geometrical modifications compared to the standard versions has been avoided so as not to affect their dimensional compatibility with the latter:

The passage of a cable through a shield must be properly considered. One common method is to place filters on the cable at which it crosses the shield. Another is to use shielded cables, with their shields connected for the entire perimeter to the equipment shield.

To reduce radiated emissions of a cable, the cable shield must be connected to a point with zero potential (an ideal ground therefore, not the "signal" ground of an electronic circuit).

To achieve electromagnetic shielding conductive materials (metals) are used.

Shielding attenuation depends mainly on the electrical conductivity of the material and the thickness of the shield.

Rectangular or square connectors – special case – intrinsically *anisotropic*, are more difficult to shield and less predictable in behaviour than circular connectors (isotropic geometry) used, not by accident, with coaxial terminations for RF applications.

Connector enclosures are typically made of aluminium die cast alloy, an excellent metal for shielding electric fields because it is an excellent conductor. It is also better than steel in shielding phenomena of an impulsive nature (typical example is electrostatic discharge) which cause interference in the high frequency spectrum and is among the most insidious and dangerous.

**It is important to ensure electrical continuity along the boundary of the enclosure**, not only to ensure high shielding attenuation but also to avoid accumulation of static electricity.

It is important not to "economically" tip the balance of a screening system which is only as effective as its weakest component.

A good shielded cable has a shield attenuation greater than that attributable to the connector, but only for very small lengths of cable (e.g. one metre). When the length of the shielded cable increases, shield attenuation is significantly reduced.

This indicates that it is much more important to improve the shield quality of cables, which are mainly responsible for radiated interference emissions and in an electrical system are often present in considerable quantity, before that of the connector.

What dramatically increases the efficiency of shielding is the quality of its connection to the conductor: EMC cable glands create a very homogeneous and continuous contact between the cable shield and connector enclosure.

in using EMC enclosures the equipment designer need not foresee any changes in layout due to increased dimensions and need not renounce the convenience of the traditional locking lever closures.

The increase in shielding attenuation is achieved primarily by providing a homogeneous and as uniform as possible electrical continuity of earthing to the cable shield in the connection between cable and hood and between hood and housing.

At the contact between the bulkhead-mounting housings and the fixing surface a special conductive gasket is foreseen.



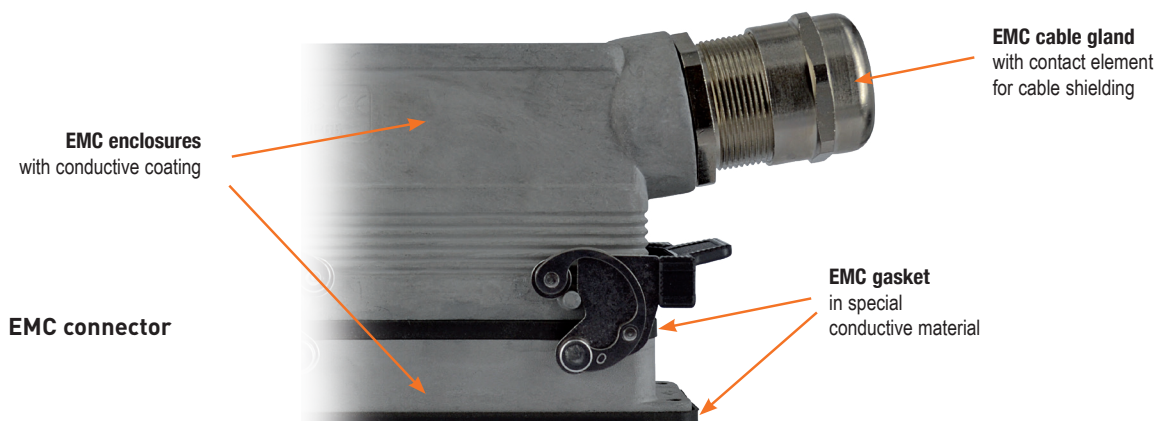

The enclosure surfaces are treated to make them extremely conductive while maintaining the necessary corrosion resistance.

The bulkhead mounting housing has a special conductive gasket.

For best results the surface underneath the gasket should be conductive. Since the use of this enclosure system presupposes the use of shielded cables, the hood should comprise a special cable gland with anchoring device for the cable shield.

These metal cable glands ensure IP66 protection rating, are resistant to corrosion and equipped internally with a contact element with geometry that ensures uniform earthing of the cable conductor shield on the metal shell of the hood.

Even with standard enclosures (not EMC), the contact with an EMC cable gland between the cable shield and the connector housing, permanently earthed through to the connector insert inside, produces an attenuation of

electromagnetic interference on average higher (by approx. 6 – 15 dB up to 600 MHz, corresponding to a factor of 2 – 5,6) than the attenuation achieved by connecting the shield mesh directly to the earth terminal of the connector insert.

The reasons for this are:

- the uniform 360° contact via the contact device of the EMC cable gland avoids what instead happens when the shield mesh is earthed to the earth terminal of the connector, i.e. the discontinuity of the shield which necessarily opens precisely around the connector;
- more efficient distribution of induced current circulating on the shield mesh;
- directly involving the metal shell constituted by the enclosure avoids transmitting interference to the connector, as happens when the shield is connected to the earth terminal of the connector.

### Experimental tests

Tests for measurement of the shielding of ILME special EMC enclosures for multipole rectangular connectors for industrial use were conducted at the CESI EMC Laboratory in Milan, national notified body for certification under the EMC Directive. Shielding attenuation of a component is defined as the ratio of the power radiated within the component and the maximum interference power outside the component in the room (**VG 95214-11**).

For a connector it can be expressed, in analogy with cables, as a function of transfer impedance, which is the ratio between the voltage induced in the shield and the current flowing outside the same. The transfer impedance measurement is a widely used and accepted method to determine shielding attenuation of coaxial cables and connectors.

Only recently, due to the increase in digital data transmission speeds and the increase in frequencies of transmitted signals, the issue of identifying efficient and repeatable methods for measuring shielding efficiency, also for connectors traditionally considered low frequency, has been addressed at a regulatory level.

An experimental method for determining surface transfer impedance of coupled low frequency connectors is still being studied by IEC.

The method chosen by ILME for verification of its system of EMC enclosures and accessories is the **line injection method** based on German military standards **VG 95214-10** and **VG 95214-11**.

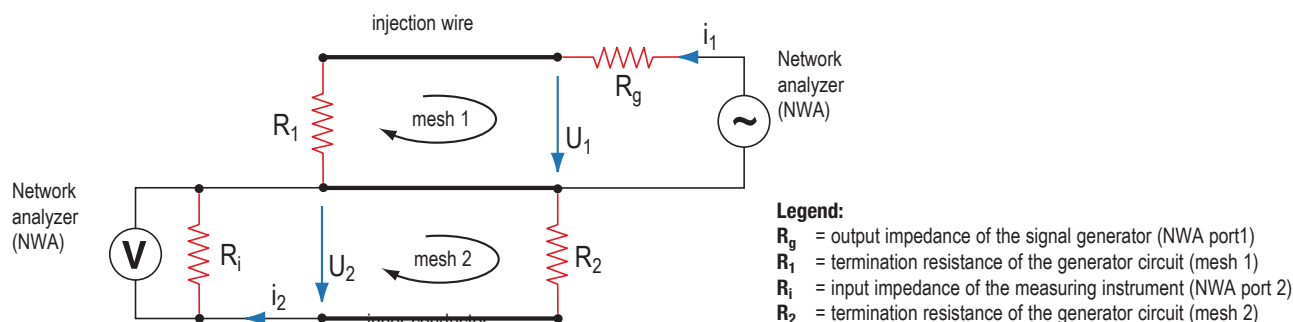

# Connectors and electromagnetic compatibility

A signal with a frequency of 0,1 MHz to 1000 MHz generated by port 1 of the measuring device (a network analyzer with 75 Ω output impedance) circulates in the mesh 1 consisting of an insulated conductor (injection wire) resting on the surface of two coupled enclosures (shield), terminating on a calibrated (and shielded) resistance of 75 Ω. As a result of the current  $i_1$  injected in the mesh 1, an induced voltage  $U_2$  is generated in the mesh 2, consisting of an inner pick-up conductor connected to two

contacts at the center of the connector inserts, terminated on another calibrated resistance of 75 Ω (shielded), in turn earthed on the coupled enclosures which act as a shield. The voltage is measured on port 2 of the measuring device for S parameters (scattering parameters). The network analyzer sees the device under test as a filter and calculates the measurement providing a graph illustrating the **shielding attenuation** (measured in dB) as a function of frequency in MHz.

The tests were performed on:   
 - coupled standard enclosures   
 - coupled EMC enclosures

The results are summarized in the diagrams below.

Figure 1 - Standard enclosure diagram

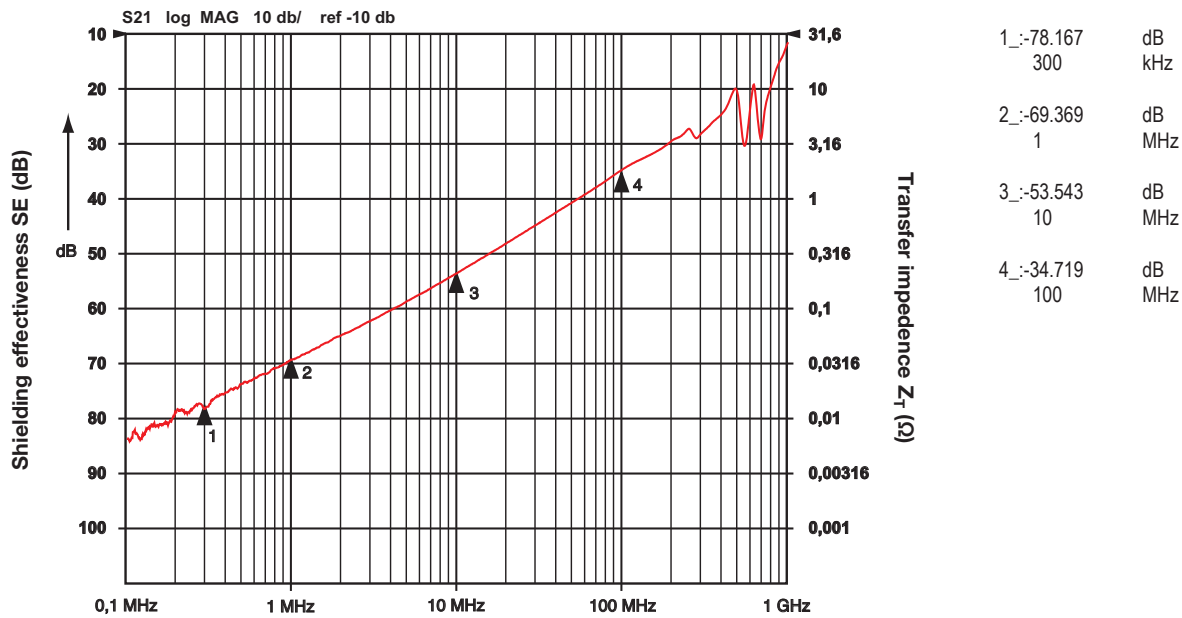
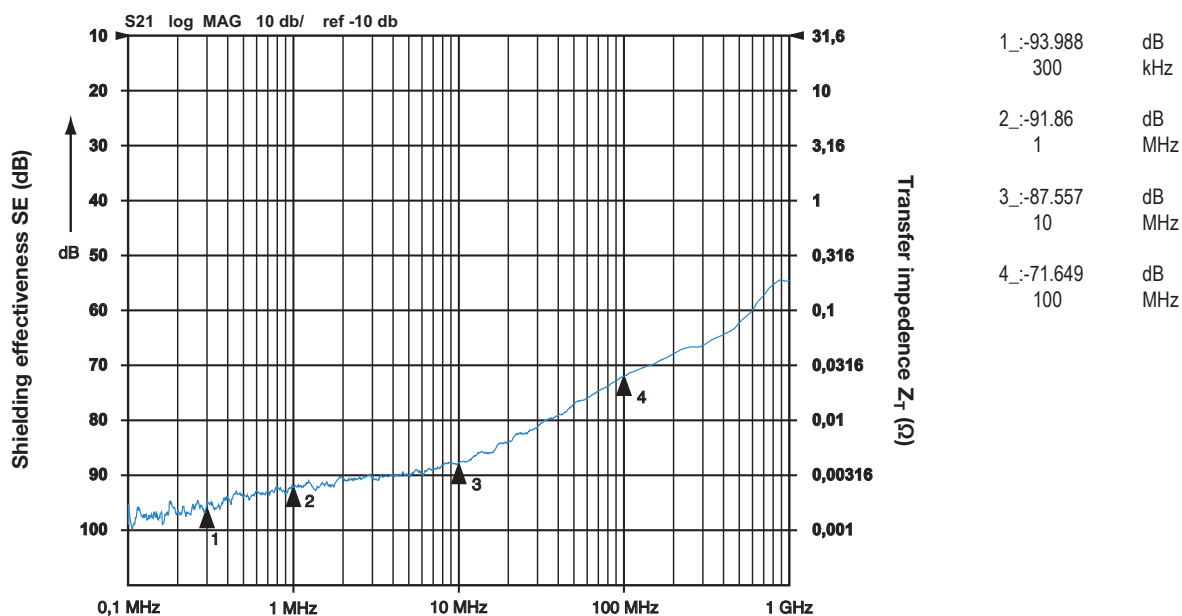

Figure 2 - EMC enclosure diagram



To highlight the influence of the cable gland the shielding attenuation measurements were repeated on:

- coupled standard enclosures with standard cable gland and cable shield earthed to the earth terminal of the connector  
**see curve A**
- coupled standard enclosures with EMC cable gland and cable shield earthed to the cable gland  
**see curve B**

- coupled EMC enclosures with EMC cable gland and cable shield earthed to the cable gland  
**see curve C**

The results are summarized in the diagrams of Figure 3 below.

Figure 3 - Overview diagrams

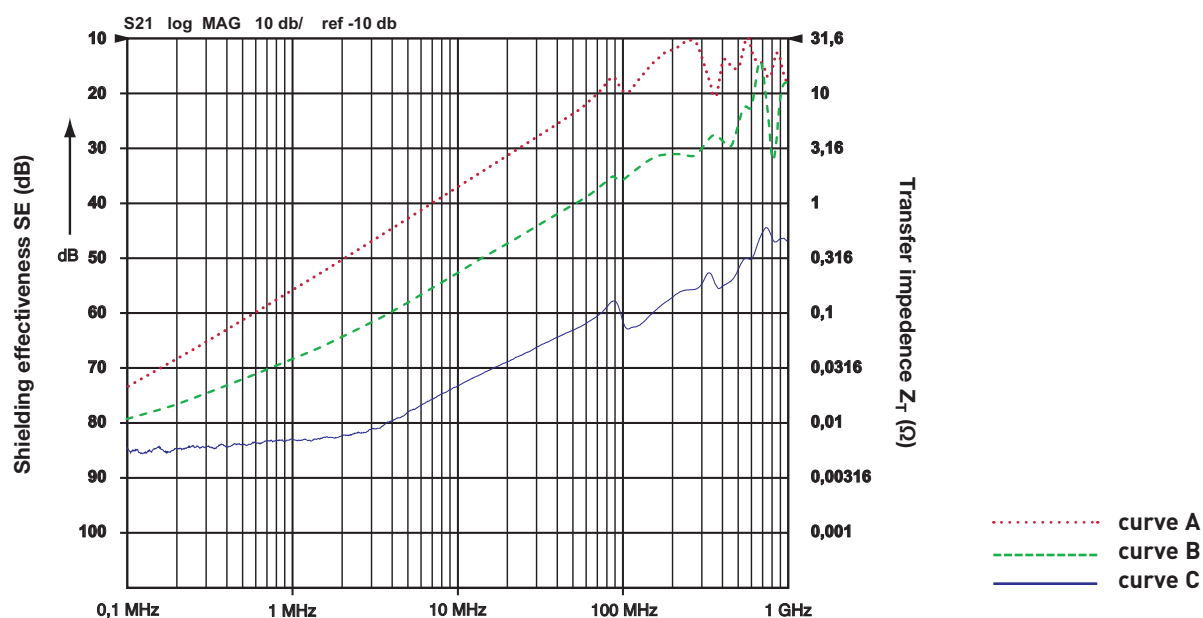

#### NOTE

For the relationship between Shielding effectiveness SE and Transfer impedance ( $\Omega$ ) see also IEC 60512-23-3:  $SE = 40 - 20_{\log} 10Z_T$  (dB)

#### Conclusions

The measurements suggest the following considerations:

- standard enclosures already provide good levels of shielding attenuation;

- when used with EMC cable glands, standard enclosures clearly increase their shielding attenuation;
- EMC enclosures, with better shielding attenuation values, provide further improvements.

inserts		page:
CK	3 poles + ⊕	58
CK	4 poles + ⊕	58
CKS	3 poles + ⊕	-
CKS	4 poles + ⊕	-
CKSH	3 poles + ⊕	63
CKSH	4 poles + ⊕	63
CD	8 poles	67
CQ4	2 poles + ⊕	182
CQ4 H	2 poles + ⊕	183
CQ4	3 poles + ⊕	184
CQ	5 poles + ⊕	186
CQ	7 poles + ⊕	187
CQ	12 poles + ⊕	189
CQ	21 poles + ⊕	190

**bulkhead mounting housings straight and angled**

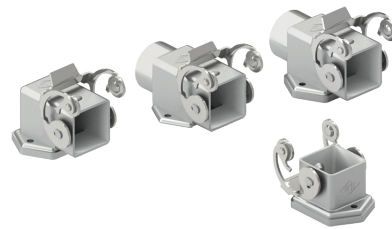

**hoods**



description	part No. (entry - Pg11)	part No. (entry - M20)	part No. (entry - Pg11)	part No. (entry - M20 / M25)
with stainless steel lever and gasket	<b>CKAXS 03 I</b>			
without cable entry, with stainless steel lever and gasket	<b>CKAXS 03 IA</b>			
with cable entry, with stainless steel lever and gasket	<b>CKAXS 03 IAP</b>	<b>MKAXS IAP20</b>		
with cable entry, with stainless steel lever and gasket	<b>CKAXS 03 AP</b>	<b>MKAXS AP20</b>		
with cable entry, with stainless steel lever and gasket			<b>CKAS 03 V</b>	<b>MKAS V20</b>
with pegs, top entry			<b>CKAS 03 VA</b>	<b>MKAS V25</b>
with pegs, top entry			<b>CKAXS 03 VG</b>	<b>MKAXS VG20</b>
with pegs, side entry			<b>CKR 65</b>	
with stainless steel lever, top entry			<b>CKR 65 D</b>	
gasket and screw kit for IP66/IP67/IP69 1)	<b>CKR 65</b>			
for CK, CKSH, CQ4, CQ inserts				
gasket and screw kit for IP66/IP67/IP69 1)	<b>CKR 65 D</b>			
for CD 08 inserts				

1) To obtain the IP66/IP67/IP69 degree of protection, a kit with insert fixing screw and gasket can be purchased separately.  
Several inserts size "21.21" are already supplied with fixing screw and gasket, which ensures IP66/IP67/IP69 degree of protection. See list below, not including any special version:

- CQF/M 07, CQF/M 12
- CJ KF/M, CJF/M 4 /4/2 /8 /8/2
- CJK 8FT /8IFT /8MT /8IMT, CJK 8M
- CUK 2FT /3FT
- CX 1/2 BDF/M
- CLK 04 SCF /SCF-H /SCM
- CXL 2/4 PF /PM /PFH /PMH /SF /SM, CXL SF/M

NOTE: Housing type and colour may vary upon specific part No.

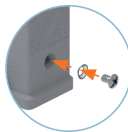

panel cut-out for bulkhead mounting housings

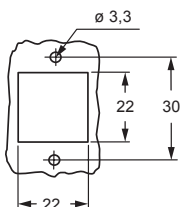

**CAIUS**® Type 12  
Type 4/4X only  
with CKR 65 (D)



IP66/IP67/IP69 with CKR 65 (D) 1)

**CKAXS I**

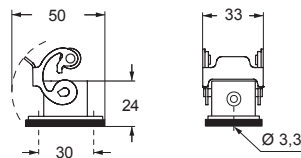

**CKAXS IA**

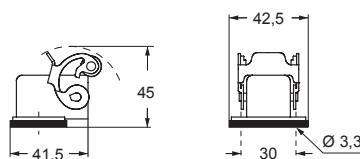

**CKAXS IAP (CKAXS AP) and MKAXS IAP (MKAXS AP)**

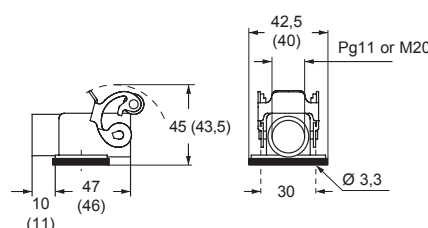

**CKAS V and MKAS V**

**MKAS V25**

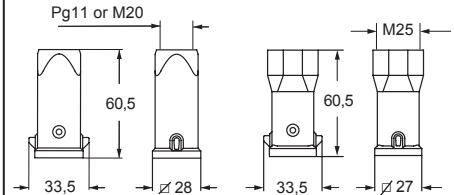

**CKAS VA and MKAS VA**

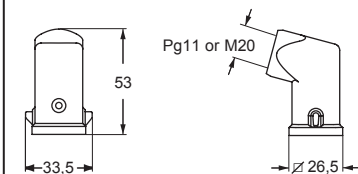

**CKAXS VG and MKAXS VG**

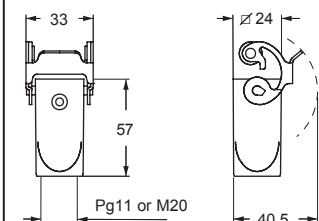

EMC

# CKAX - CKA - CKAXX EMC version for electromagnetic compatibility

inserts		page:
CK	3 poles + ⊕	58
CK	4 poles + ⊕	58
CKS	3 poles + ⊕	-
CKS	4 poles + ⊕	-
CKSH	3 poles + ⊕	63
CKSH	4 poles + ⊕	63
CD	8 poles	67
CQ4	2 poles + ⊕	182
CQ4 H	2 poles + ⊕	183
CQ4	3 poles + ⊕	184
CQ	5 poles + ⊕	186
CQ	7 poles + ⊕	187
CQ	12 poles + ⊕	189
CQ	21 poles + ⊕	190

## angled bulkhead mounting housings with stainless steel lever



## angled bulkhead mounting housings with galvanized steel rigid lever and stainless steel rigid lever

GALVANIZED \*



STAINLESS \*\*



description	part No.	part No.
without cable entry, fixing by 4 screws	<b>CKAXS 03 IA4</b>	
without cable entry, fixing by 4 screws		<b>CKAS 03 IA4 *</b>
without cable entry, fixing by 4 screws		<b>CKAXXS 03IA4 **</b>
gasket and screw kit for IP66/IP67/IP69 1) for CK, CKSH, CQ4, CQ inserts	<b>CKR 65</b>	<b>CKR 65</b>
gasket and screw kit for IP66/IP67/IP69 1) for CD 08 inserts	<b>CKR 65 D</b>	<b>CKR 65 D</b>

1) To obtain the IP66/IP67/IP69 degree of protection, a kit with insert fixing screw and gasket can be purchased separately. Several inserts size "21.21" are already supplied with fixing screw and gasket, which ensures IP66/IP67/IP69 degree of protection. See list below, not including any special version:

- CQF/M 07, CQF/M 12
- CJ KF/M, CJF/M 4 /4/2 /8 /8/2
- CJK 8FT /8IFT /8MT /8IMT, CJK 8M
- CUK 2FT /3FT
- CX 1/2 BDF/M
- CLK 04 SCF /SCF-H /SCM
- CXL 2/4 PF /PM /PFH /PMH /SF /SM, CXL SF/M

NOTE: Housing type and colour may vary upon specific part No.

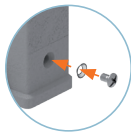

### CKAXS IA4

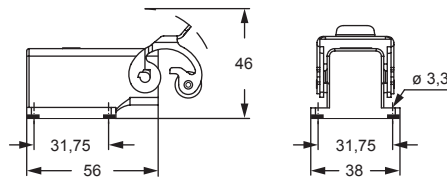

### panel cut-out for enclosures

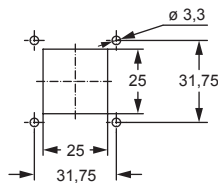

### CKAS IA4 - CKAXXS IA4

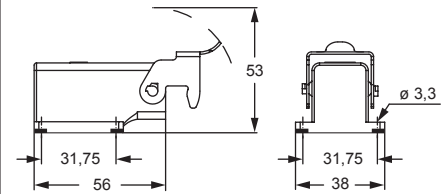

### panel cut-out for enclosures

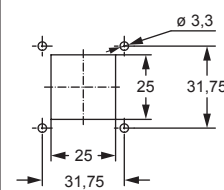

IP44 IP66/IP67/IP69 with CKR 65 (D) 1)

# MKAX EMC version for electromagnetic compatibility

inserts		page:
CK	3 poles + ⊕	58
CK	4 poles + ⊕	58
CKS	3 poles + ⊕	-
CKS	4 poles + ⊕	-
CKSH	3 poles + ⊕	63
CKSH	4 poles + ⊕	63
CD	8 poles	67
CQ4	2 poles + ⊕	182
CQ4 H	2 poles + ⊕	183
CQ4	3 poles + ⊕	184
CQ	5 poles + ⊕	186
CQ	7 poles + ⊕	187
CQ	12 poles + ⊕	189
CQ	21 poles + ⊕	190

## angled surface mounting housings with stainless steel lever



## angled surface mounting housings with stainless steel lever



description	part No. (entry - M25)	part No. (entry - M25)
with cable entry, fixing by 4 screws	<b>MKAXS IAP25</b>	
with cable entry, fixing by 4 screws, bulkhead hole closed (without gasket)		<b>MKAXS AP25</b>
gasket and screw kit for IP66/IP67/IP69 1) for CK, CKSH, CQ4, CQ, inserts	<b>CKR 65</b>	<b>CKR 65</b>
gasket and screw kit for IP66/IP67/IP69 1) for CD 08 inserts	<b>CKR 65 D</b>	<b>CKR 65 D</b>

1) To obtain the IP66/IP67/IP69 degree of protection, a kit with insert fixing screw and gasket can be purchased separately.  
Several inserts size "21.21" are already supplied with fixing screw and gasket, which ensures IP66/IP67/IP69 degree of protection. See list below, not including any special version:

- CQF/M 07, CQF/M 12
- CJ KF/M, CJF/M 4 /4/2 /8 /8/2
- CJK 8FT /8IFT /8MT /8IMT, CJK 8M
- CUK 2FT /3FT
- CX 1/2 BDF/M
- CLK 04 SCF /SCF-H /SCM
- CXL 2/4 PF /PM /PFH /PMH /SF /SM, CXL SF/M

NOTE: Housing type and colour may vary upon specific part No.

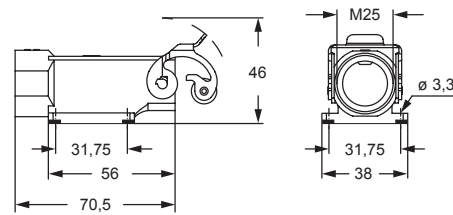
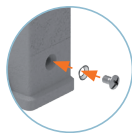

panel cut-out for enclosures

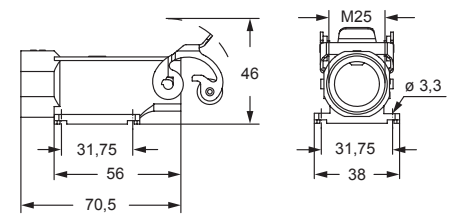
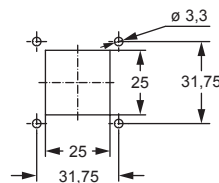

panel cut-out for enclosures

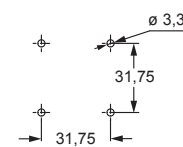

IP66/IP67/IP69 with CKR 65 (D) 1)

EMC



# MKA - MKAXX EMC version for electromagnetic compatibility

inserts		page:
CK	3 poles + ⊕	58
CK	4 poles + ⊕	58
CKS	3 poles + ⊕	-
CKS	4 poles + ⊕	-
CKSH	3 poles + ⊕	63
CKSH	4 poles + ⊕	63
CD	8 poles	67
CQ4	2 poles + ⊕	182
CQ4 H	2 poles + ⊕	183
CQ4	3 poles + ⊕	184
CQ	5 poles + ⊕	186
CQ	7 poles + ⊕	187
CQ	12 poles + ⊕	189
CQ	21 poles + ⊕	190

## angled surface mounting housings with galvanized steel rigid lever

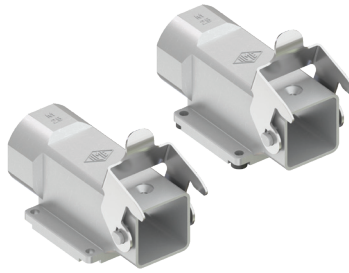

## angled surface mounting housings with stainless steel rigid lever

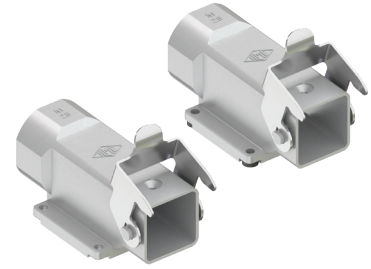

description	part No. (entry - M25)	part No. (entry - M25)
with cable entry, fixing by 4 screws	<b>MKAS IAP25</b>	
with cable entry, fixing by 4 screws, bulkhead hole closed (without gasket)	<b>MKAS AP25</b>	
with cable entry, fixing by 4 screws		<b>MKAXXS IAP25</b>
with cable entry, fixing by 4 screws, bulkhead hole closed (without gasket)		<b>MKAXXS AP25</b>
gasket and screw kit for IP66/IP67 <sup>1)</sup> for CK, CKSH, CQ4, CQ, inserts	<b>CKR 65</b>	<b>CKR 65</b>
gasket and screw kit for IP66/IP67 <sup>1)</sup> for CD 08 inserts	<b>CKR 65 D</b>	<b>CKR 65 D</b>

1) To obtain the IP66/IP67/IP69 degree of protection, a kit with insert fixing screw and gasket can be purchased separately.  
Several inserts size "21.21" are already supplied with fixing screw and gasket, which ensures IP66/IP67/IP69 degree of protection. See list below, not including any special version:

- CQF/M 07, CQF/M 12
- CJ KF/M, CJF/M 4 /4/2 /8 /8/2
- CJK 8FT /8IFT /8MT /8IMT, CJK 8M
- CUK 2FT /3FT
- CX 1/2 BDF/M
- CLK 04 SCF /SCF-H /SCM
- CXL 2/4 PF /PM /PFH /PMH /SF /SM, CXL SF/M

NOTE: Housing type and colour may vary upon specific part No.

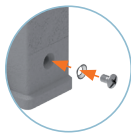

### MKAS IAP

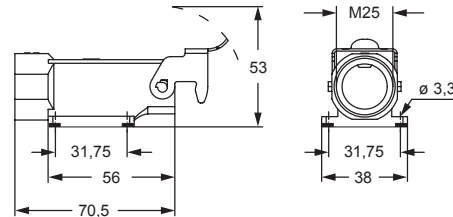

### panel cut-out for enclosures

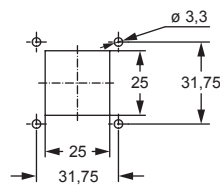

### MKAS AP

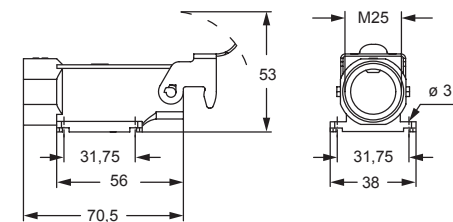

### panel cut-out for enclosures

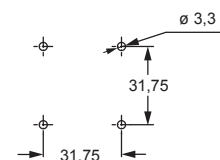

### MKAXXS IAP

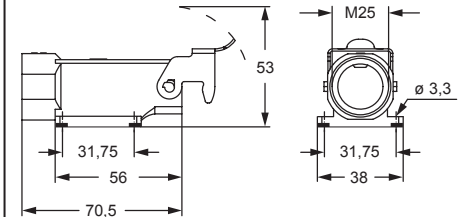

### panel cut-out for enclosures

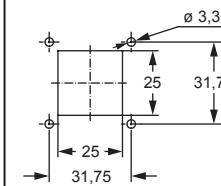

### MKAXXS AP

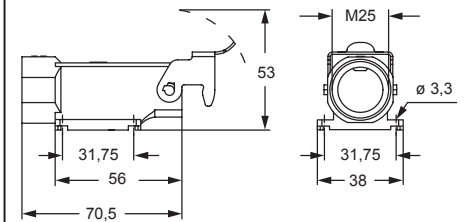

### panel cut-out for enclosures

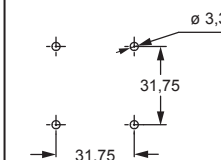

IP44 IP66/IP67/IP69 with CKR 65 (D) <sup>1)</sup>

# MKAX EMC version for electromagnetic compatibility

inserts		page:
CK	3 and 4 poles + ⊕	58
CKS	3 and 4 poles + ⊕	-
CKSH	3 and 4 poles + ⊕	63
CD	8 poles	67
CQ4	2 poles + ⊕	182
CQ4 H	2 poles + ⊕	183
CQ4	3 poles + ⊕	184
CQ	5 poles + ⊕	186
CQ	7 poles + ⊕	187
CQ	12 poles + ⊕	189
CQ	21 poles + ⊕	190
CJ KF		305
CJK 8FT		308
CLK 04 SC		321
CX 1/2 BD		325
CXL 2/4 SF/SM		332
CXL SF/SM		332
CXL 2/4 PF/PM		333
CXL 2/4 PFH/PMH		333
CXL PF/PM		333

## bulkhead mounting housings with stainless steel lever



 AVAILABLE MAY 2019

description	part No. (entry - M32)
M32 fixing thread <sup>(*) 1)</sup>	<b>MKAXS IF</b>
gasket and screw kit for IP66/IP67/IP69 <sup>1)</sup>	<b>CKR 65</b>
gasket and screw kit for IP66/IP67/IP69 <sup>1)</sup> specific for CD 08 inserts	<b>CKR 65 D</b>

<sup>1)</sup> To obtain the IP66/IP67/IP69 degree of protection, a kit with insert fixing screw and gasket can be purchased separately. Several inserts size "21.21" are already supplied with fixing screw and gasket, which ensures IP66/IP67/IP69 degree of protection. See list below, not including any special version:

- CQF/M 07, CQF/M 12
- CJ KF/M, CJF/M 4 /4/2 /8 /8/2
- CJK 8FT /8IFT /8MT /8IMT, CJK 8M
- CUK 2FT /3FT
- CX 1/2 BDF/M
- CLK 04 SCF /SCF-H /SCM
- CXL 2/4 PF /PM /PFH /PMH /SF /SM, CXL SF/M

 NOTE: Housing type and colour may vary upon specific part No.

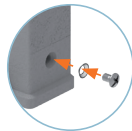

<sup>(\*)</sup> Locknut supplied on request, see Cable glands catalogue (article AS M32N metallic).

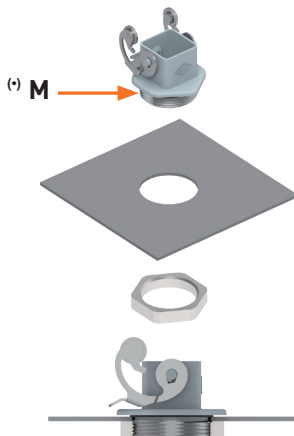

 NOTE: Lever type and housing colour may vary upon specific part No.

cURus  
Type 4/4X/12 pending



IP66/IP67/IP69 with CKR 65 (D) <sup>1)</sup>

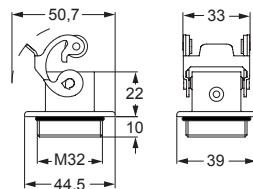

panel cut-out for enclosures

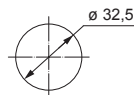

EMC

# MKA - MKAXX EMC version for electromagnetic compatibility

inserts		page:
CK	3 and 4 poles + ⊕	58
CKS	3 and 4 poles + ⊕	-
CKSH	3 and 4 poles + ⊕	63
CD	8 poles	67
CQ4	2 poles + ⊕	182
CQ4 H	2 poles + ⊕	183
CQ4	3 poles + ⊕	184
CQ	5 poles + ⊕	186
CQ	7 poles + ⊕	187
CQ	12 poles + ⊕	189
CQ	21 poles + ⊕	190
CJ KF		305
CJK 8FT		308
CLK 04 SC		321
CX 1/2 BD		325
CXL 2/4 SF/SM		332
CXL SF/SM		332
CXL 2/4 PF/PM		333
CXL 2/4 PFH/PMH		333
CXL PF/PM		333

## bulkhead mounting housings with galvanized steel rigid lever



AVAILABLE MAY 2019

## bulkhead mounting housings with stainless steel rigid lever



AVAILABLE MAY 2019

description	part No. (entry - M32)	part No. (entry - M32)
M32 fixing thread <sup>(*)</sup> 1)	<b>MKAS IF</b>	
M32 fixing thread <sup>(*)</sup> 1)		<b>MKAXXS IF</b>
gasket and screw kit for IP66/IP67/IP69 <sup>1)</sup>	<b>CKR 65</b>	<b>CKR 65</b>
gasket and screw kit for IP66/IP67/IP69 <sup>1)</sup> specific for CD 08 inserts	<b>CKR 65 D</b>	<b>CKR 65 D</b>

1) To obtain the IP66/IP67/IP69 degree of protection, a kit with insert fixing screw and gasket can be purchased separately.  
Several inserts size "21.21" are already supplied with fixing screw and gasket, which ensures IP66/IP67/IP69 degree of protection. See list below, not including any special version:

- CQF/M 07, CQF/M 12
- CJ KF/M, CJF/M 4 /4/2 /8 /8/2
- CJK 8FT /8IFT /8MT /8IMT, CJK 8M
- CUK 2FT /3FT
- CX 1/2 BDF/M
- CLK 04 SCF /SCF-H /SCM
- CXL 2/4 PF /PM /PFH /PMH /SF /SM, CXL SF/M

NOTE: Housing type and colour may vary upon specific part No.

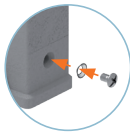

<sup>(\*)</sup> Locknut supplied on request, see Cable glands catalogue (article AS M32N metallic).

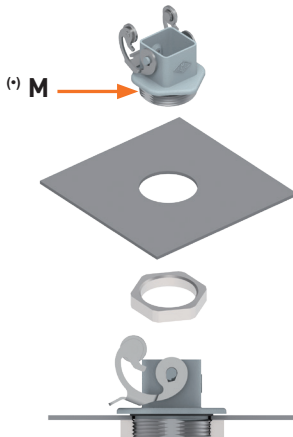

NOTE: Lever type and housing colour may vary upon specific part No.

cURus  
Type 4/4X/12 pending

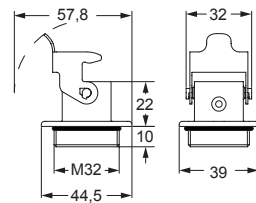
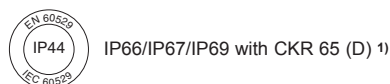

panel cut-out for enclosures

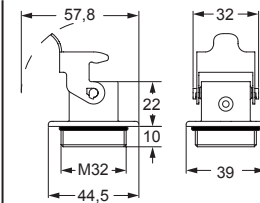
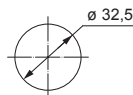

panel cut-out for enclosures

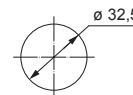

# MKAX EMC version for electromagnetic compatibility

inserts		page:
CK	3 and 4 poles + ⊕	58
CKS	3 and 4 poles + ⊕	-
CKSH	3 and 4 poles + ⊕	63
CD	8 poles	67
CQ4	2 poles + ⊕	182
CQ4 H	2 poles + ⊕	183
CQ4	3 poles + ⊕	184
CQ	5 poles + ⊕	186
CQ	7 poles + ⊕	187
CQ	12 poles + ⊕	189
CQ	21 poles + ⊕	190
CJ KF		305
CJK 8FT		308
CLK 04 SC		321
CX 1/2 BD		325
CXL 2/4 SF/SM		332
CXL SF/SM		332
CXL 2/4 PF/PM		333
CXL 2/4 PFH/PMH		333
CXL PF/PM		333

## bulkhead mounting housings with stainless steel lever

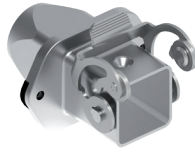

description	part No. (entry - M20)
M20 cable entry 1)	<b>MKAXS IVG20</b>
gasket and screw kit for IP66/IP67/IP69 1)	<b>CKR 65</b>
gasket and screw kit for IP66/IP67/IP69 1) specific for CD 08 inserts	<b>CKR 65 D</b>

1) To obtain the IP66/IP67/IP69 degree of protection, a kit with insert fixing screw and gasket can be purchased separately.  
Several inserts size "21.21" are already supplied with fixing screw and gasket, which ensures IP66/IP67/IP69 degree of protection. See list below, not including any special version:

- CQF/M 07, CQF/M 12
- CJ KF/M, CJF/M 4 /4/2 /8 /8/2
- CJK 8FT /8IFT /8MT /8IMT, CJK 8M
- CUK 2FT /3FT
- CX 1/2 BDF/M
- CLK 04 SCF /SCF-H /SCM
- CXL 2/4 PF /PM /PFH /PMH /SF /SM, CXL SF/M

NOTE: Housing type and colour may vary upon specific part No.

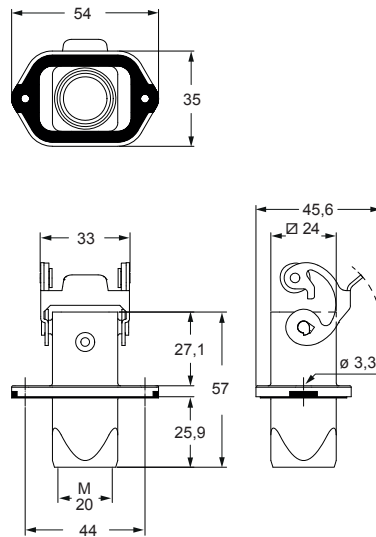
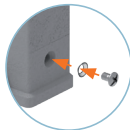

panel cut-out for enclosures

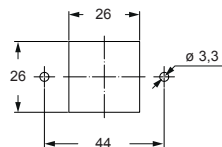

cURus  
Type 12 / Type 4/4X only with CKR 65 (D) pending



IP44 IP66/IP67/IP69 with CKR 65 (D) 1)

EMC

# MKA - MKAXX EMC version for electromagnetic compatibility

inserts		page:
CK	3 and 4 poles + ⊕	58
CKS	3 and 4 poles + ⊕	-
CKSH	3 and 4 poles + ⊕	63
CD	8 poles	67
CQ4	2 poles + ⊕	182
CQ4 H	2 poles + ⊕	183
CQ4	3 poles + ⊕	184
CQ	5 poles + ⊕	186
CQ	7 poles + ⊕	187
CQ	12 poles + ⊕	189
CQ	21 poles + ⊕	190
CJ KF		305
CJK 8FT		308
CLK 04 SC		321
CX 1/2 BD		325
CXL 2/4 SF/SM		332
CXL SF/SM		332
CXL 2/4 PF/PM		333
CXL 2/4 PFH/PMH		333
CXL PF/PM		333

## bulkhead mounting housings with galvanized steel rigid lever

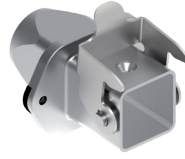

## bulkhead mounting housings with stainless steel rigid lever

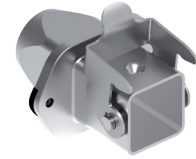

description	part No. (entry - M20)	part No. (entry - M20)
M20 cable entry <sup>1)</sup>	<b>MKAS IVG20</b>	
M20 cable entry <sup>1)</sup>		<b>MKAXXS IVG20</b>
gasket and screw kit for IP66/IP67/IP69 <sup>1)</sup>	<b>CKR 65</b>	<b>CKR 65</b>
gasket and screw kit for IP66/IP67/IP69 <sup>1)</sup> specific for CD 08 inserts	<b>CKR 65 D</b>	<b>CKR 65 D</b>

<sup>1)</sup> To obtain the IP66/IP67/IP69 degree of protection, a kit with insert fixing screw and gasket can be purchased separately.  
Several inserts size "21.21" are already supplied with fixing screw and gasket, which ensures IP66/IP67/IP69 degree of protection. See list below, not including any special version:

- CQF/M 07, CQF/M 12
- CJ KF/M, CJF/M 4 /4/2 /8 /8/2
- CJK 8FT /8IFT /8MT /8IMT, CJK 8M
- CUK 2FT /3FT
- CX 1/2 BDF/M
- CLK 04 SCF /SCF-H /SCM
- CXL 2/4 PF /PM /PFH /PMH /SF /SM, CXL SF/M

NOTE: Housing type and colour may vary upon specific part No.

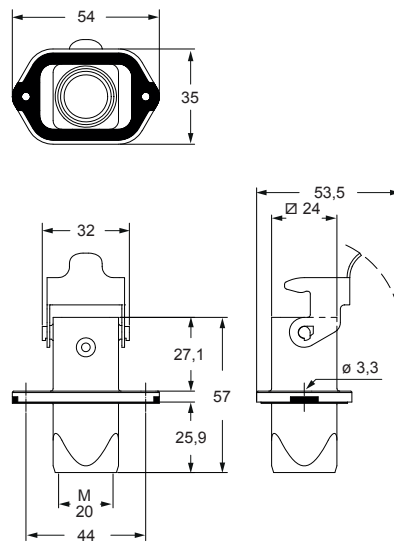
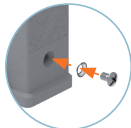

panel cut-out for enclosures

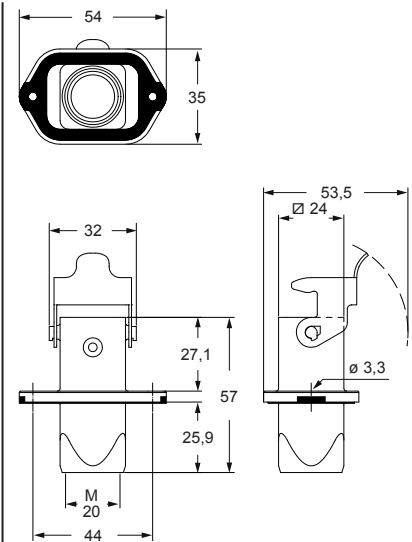
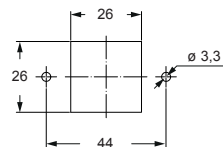

panel cut-out for enclosures

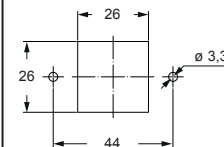

cURus  
Type 12 / Type 4/4X only with CKR 65 (D) pending



IP66/IP67/IP69 with CKR 65 (D) <sup>1)</sup>

# MKAX - MKA - MKAXX EMC version for electromagnetic compatibility

inserts	page:
CK	3 and 4 poles + ⊕ 58
CKS	3 and 4 poles + ⊕ -
CKSH	3 and 4 poles + ⊕ 63
CD	8 poles 67
CQ4	2 poles + ⊕ 182
CQ4 H	2 poles + ⊕ 183
CQ4	3 poles + ⊕ 184
CQ	5 poles + ⊕ 186
CQ	7 poles + ⊕ 187
CQ	12 poles + ⊕ 189
CQ	21 poles + ⊕ 190
CJ KM	305
CJK 8MT	308
CJK 8IMT	308
CLK 04 SC	321
CX 1/2 BD	325
CXL 2/4 SF/SM	332
CXL SF/SM	332
CXL 2/4 PF/PM	333
CXL 2/4 PFH/PMH	333
CXL PF/PM	333

## hoods with stainless steel lever



## hoods with galvanized steel rigid lever and stainless steel rigid lever

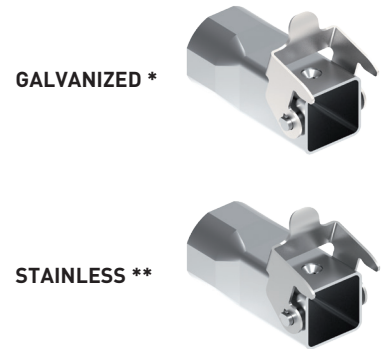

description	part No. (entry - M25)	part No. (entry - M25)
top entry	<b>MKAXS VG25</b>	
top entry		<b>MKAS VG25 *</b>
top entry		<b>MKAXXS VG25 **</b>
gasket and screw kit for IP66/IP67/IP69 1)	<b>CKR 65</b>	<b>CKR 65</b>
gasket and screw kit for IP66/IP67/IP69 1) for CD 08 inserts	<b>CKR 65 D</b>	<b>CKR 65 D</b>

1) To obtain the IP66/IP67/IP69 degree of protection, a kit with insert fixing screw and gasket can be purchased separately. Several inserts size "21.21" are already supplied with fixing screw and gasket, which ensures IP66/IP67/IP69 degree of protection. See list below, not including any special version:

- CQF/M 07, CQF/M 12
- CJ KF/M, CJF/M 4 /4/2 /8 /8/2
- CJK 8FT /8IFT /8MT /8IMT, CJK 8M
- CUK 2FT /3FT
- CX 1/2 BDF/M
- CLK 04 SCF /SCF-H /SCM
- CXL 2/4 PF /PM /PFH /PMH /SF /SM, CXL SF/M

NOTE: Housing type and colour may vary upon specific part No.

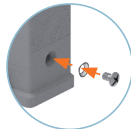

### MKAXS VG

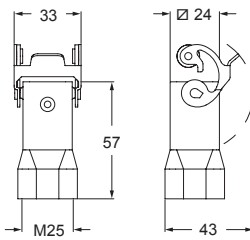

### CKAS IA4 - CKAXXS IA4

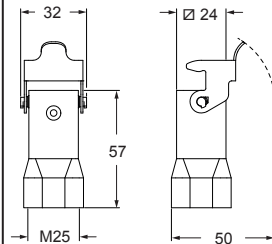

cURus  
Type 12 / Type 4/4X only with CKR 65 (D) pending



IP44 IP66/IP67/IP69 with CKR 65 (D) 1)

EMC



# CQ EMC version for electromagnetic compatibility

inserts		page:
CQ 04/2	4 poles + 2 poles + ⊕	191
CQ 08	8 poles + ⊕	192
CQ 17	17 poles + ⊕	193

metallized insulating enclosures

## bulkhead mounting housings with single lever



## angled bulkhead mounting housings with single lever



description	part No.	part No.	entry - Pg
with lever and gasket	<b>CQS 08 I</b>	<b>CQS 08 IA</b>	
without cable entry, with lever		<b>CQS 08 IAP</b>	21
with cable entry, with lever			

### CQS I

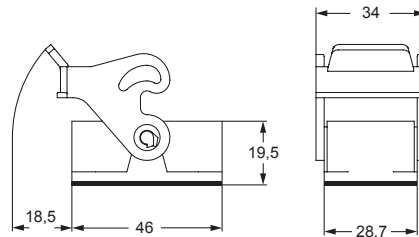

### panel cut-out for CQ I enclosure

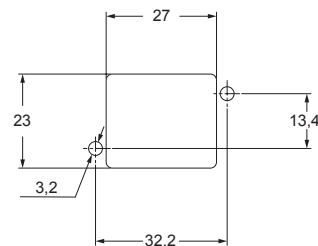

### CQS IA

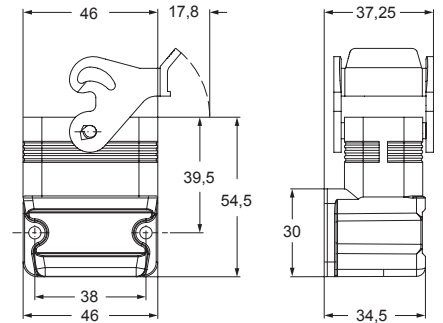

### CQS IAP

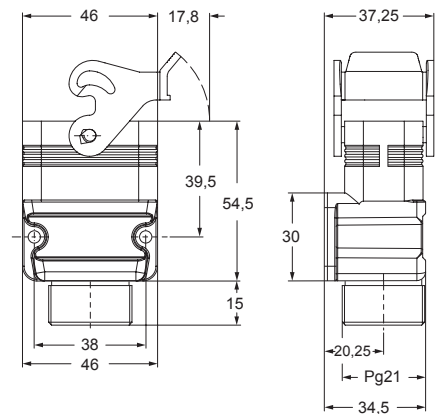

### ASSEMBLY INSTRUCTIONS

When using series "CQS 08" enclosures, replace the gasket provided with male inserts with the conductive gasket "CR 08 EMC".

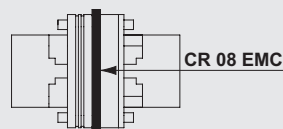

### panel cut-out for CQ IA - CQ IAP enclosure

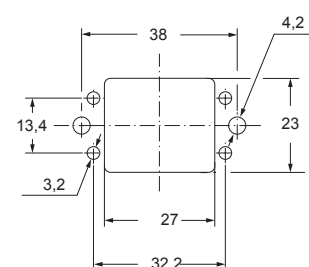

**CAIUS** Type 12



# CQ EMC version for electromagnetic compatibility

inserts		page:
CQ 04/2	4 poles + 2 poles + ⊕	191
CQ 08	8 poles + ⊕	192
CQ 17	17 poles + ⊕	193

### hoods with 2 pegs



### hoods with single lever



metallized insulating enclosures

description	part No.	entry - Pg	part No.	entry - Pg
with pegs, side entry *	<b>CQS 08 VA</b>	16		
with pegs, top entry *	<b>CQS 08 V</b>	21		
with lever, top entry *			<b>CQS 08 VG</b>	21

\* Pg male thread on enclosure exterior

### ASSEMBLY INSTRUCTIONS

When using series "CQS 08" enclosures, replace the gasket provided with male inserts with the conductive gasket "CR 08 EMC".

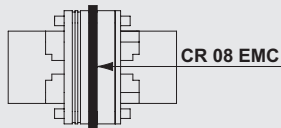

### CQS VA

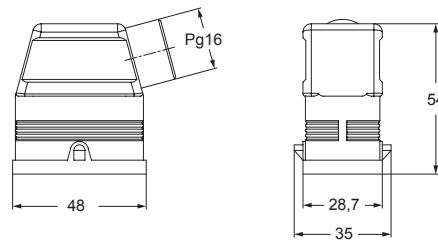

### CQS VG

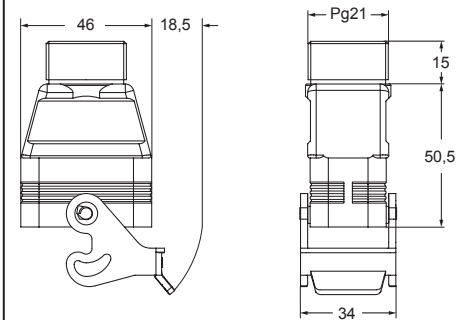

### CQS V

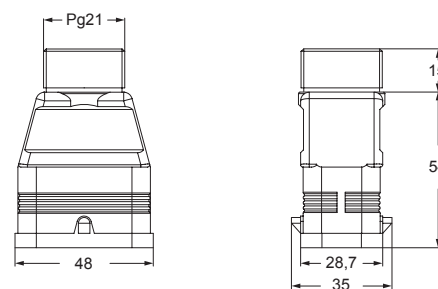

**CAUS**® Type 12



EMC

# CR - CRQ EMC version for electromagnetic compatibility

conductive gasket for CQM male inserts

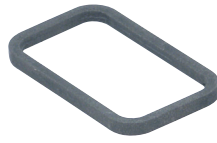

thermoplastic resin cable glands



description	part No.	part No.
-------------	----------	----------

conductive gasket for CQM male inserts	<b>CR 08 EMC</b>	
cable gland head and gasket for CQS 08 VA enclosure		<b>CRQ 16</b>
cable gland head and gasket for CQS 08 V, VG and IAP enclosure		<b>CRQ 21</b>

### ASSEMBLY INSTRUCTIONS

Place the cable shield mesh between the **CRQ** cable gland gasket and the seat of the gasket itself.

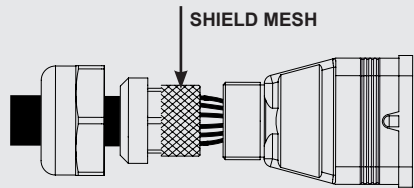

**CR 08 EMC**

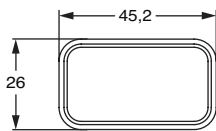

**CRQ 16 and CRQ 21**

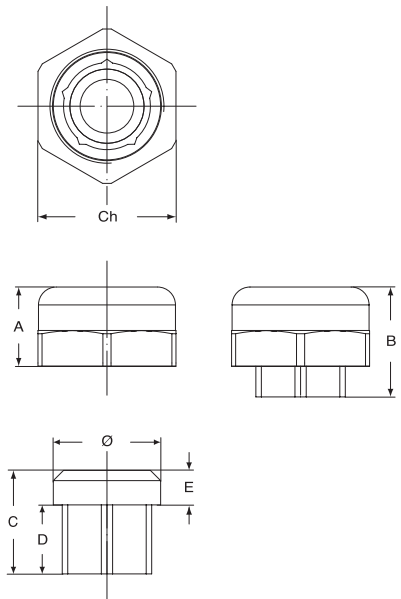

part No.	A	B	C	D	E	Ø	Ch
<b>CRQ 16</b>	15,5	21,5	20,25	13,5	6,75	21	27
<b>CRQ 21</b>	18,2	27,5	25	15,5	9	26,5	33

cable diameters for cable glands:  
 - **CRQ 16**: 10 - 14,5 mm (4 - 7 mm on request)  
 - **CRQ 21**: 14 - 18 mm (7 - 10 mm on request)

EMC

# CZ - MZ and CZF - MZF EMC version for electromagnetic compatibility

inserts		page:
CD	15 poles + ⊕	68
CDA	10 poles + ⊕	98
CSAH	10 poles + ⊕	99
CDC	10 poles + ⊕	104
MIXO	1 module	234 - 286

## housings and cover

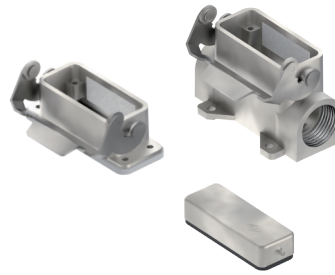

## hoods and cover



The covers for L and LG versions cannot be used together with coding pins. If this application is required, please contact ILME S.p.A.

description	part No.	entry Pg	part No.	entry M	part No.	entry Pg	part No.	entry M
bulkhead mounting housing with lever and gasket	<b>CZ7IS 15 L</b>		--					
surface mounting housing with lever	<b>CZ7PS 15 L2</b>	16 x 2	<b>MZ7PS 15L225</b>	25 x 2				
cover with pegs and gasket (for 1 lever enclosures) 1)	<b>CZCS 15 L</b>							
enclosure with pegs and gasket, side entry					<b>CZOS 15 L</b>	16	<b>MZOS 15 L20</b>	20
enclosure with pegs and gasket, side entry							<b>MZOS 15 L25</b>	25
enclosure with pegs and gasket, side entry, high construction, without adapter *					<b>CZFOS 15 L21</b>	21	<b>MZFOS 15 L25</b>	25
enclosure with pegs and gasket, top entry					<b>CZVS 15 L</b>	13,5	<b>MZVS 15 L20</b>	20
enclosure with pegs and gasket, top entry, high construction, without adapter *					<b>CZFVS 15L221</b>	21	<b>MZFVS 15 L25</b>	25
cover with lever (for enclosures with pegs) 2)					<b>CZ7CS 15 LG</b>			

\* enclosure without adapter, threaded on the enclosure body, to be used only with a complete cable gland.

panel cut-out for bulkhead mounting housings

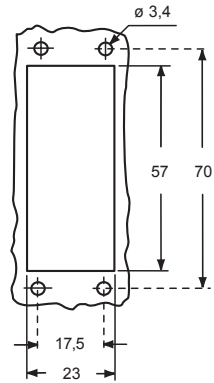

For fixing on housings

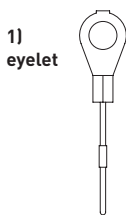

For fixing on hoods

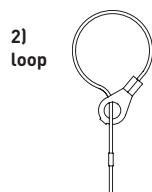

**CAIUS** Type 4/4X/12



### CZ7IS L

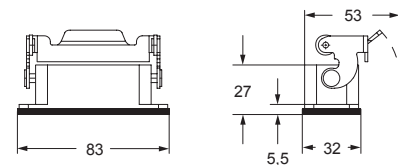

### CZ7PS L and MZ7PS L

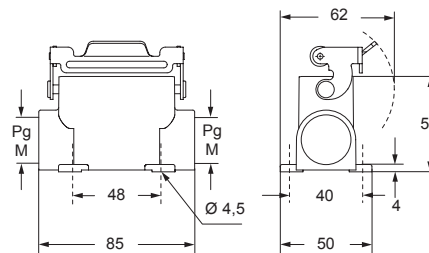

### CZCS L

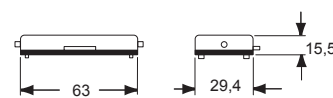

### CZOS L and MZOS L

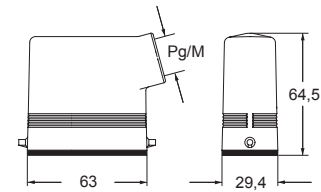

### CZFOS L - MZFOS L and CZFVS L - MZFVS L

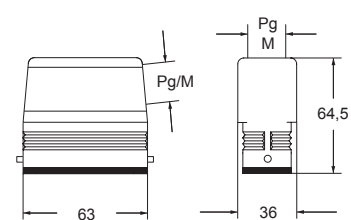

### CZVS L and MZVS L

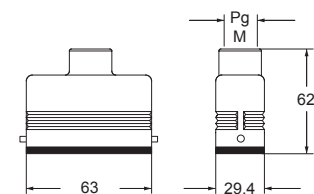

### CZ7CS LG

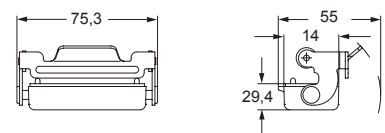

EMC



inserts		page:
CD	25 poles + ⊕	69
CDD	38 poles + ⊕	77
CDA	16 poles + ⊕	100
CSAH	16 poles + ⊕	101
CDC	16 poles + ⊕	105

The covers for L and LG versions cannot be used together with coding pins. If this application is required, please contact ILME S.p.A.

**housings and cover**

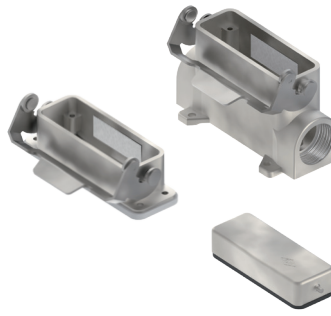

**hoods and cover**

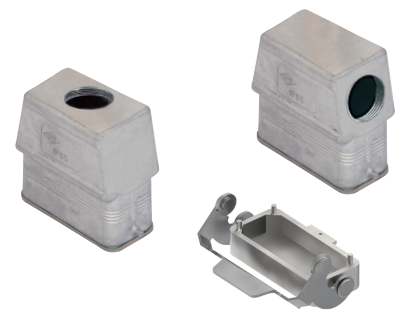

description	part No.	entry Pg	part No.	entry M	part No.	entry Pg	part No.	entry M
bulkhead mounting housing with lever and gasket	<b>CZ7IS 25 L</b>		--					
surface mounting housing, with lever, high construction	<b>CZ7PS 25 L2</b>	16 x 2	<b>MZ7PS 25L225</b>	25 x 2				
cover with pegs (for 1 lever enclosures) 1)	<b>CZCS 25 L</b>							
enclosure with pegs and gasket, side entry					<b>CZOS 25 L</b>	16	<b>MZOS 25 L20</b>	20
enclosure with pegs and gasket, side entry							<b>MZOS 25 L25</b>	25
enclosure with pegs and gasket, side entry, high construction, without adapter *					<b>CZFOS 25 L21</b>	21	<b>MZFOS 25 L25</b>	25
enclosure with pegs and gasket, top entry					<b>CZVS 25 L</b>	16	<b>MZVS 25 L20 **</b>	20
enclosure with pegs and gasket, top entry, high construction, without adapter *					<b>CZFVS 25 L21</b>	21	<b>MZFVS 25 L25</b>	25
cover with lever (for enclosures with pegs) 2)							<b>CZ7CS 25 LG</b>	

\* enclosure without adapter, threaded on the enclosure body, to be used only with a complete cable gland.

panel cut-out for bulkhead mounting housings

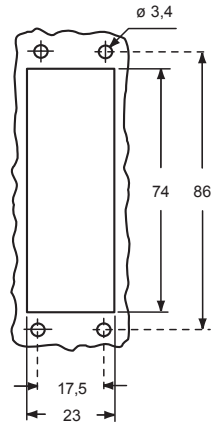

**For fixing on housings**

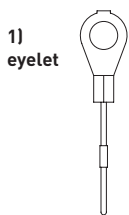

**For fixing on hoods**

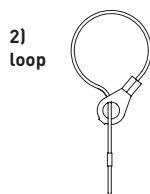

**CAIUS** Type 4/4X/12



**CZ7IS L**

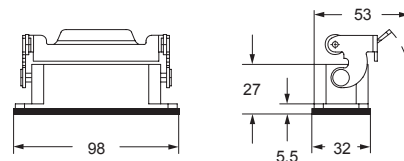

**CZ7PS L and MZ7PS L**

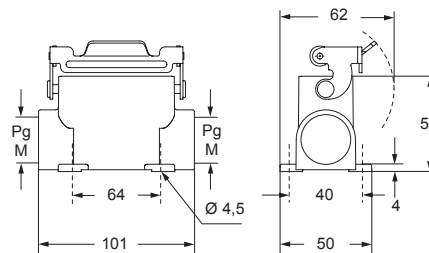

**CZCS L**

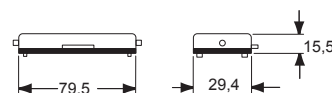

**CZOS L and MZOS L**

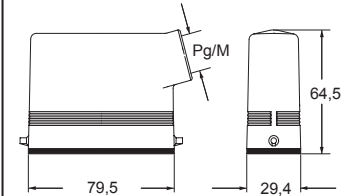

**CZFOS L - MZFOS L and CZFVS L - MZFVS L**

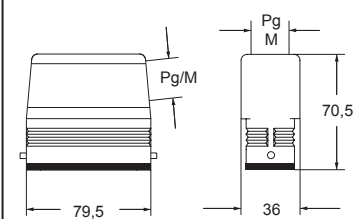

**CZVS L and MZVS L \*\***

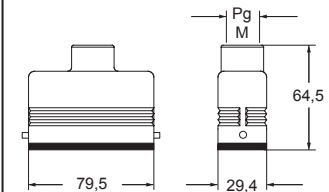

\*\* can only be used with a complete cable gland (to be purchased separately)

**CZ7CS LG**

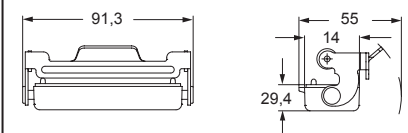

# CH - CA - CF and MA - MF EMC version for electromagnetic compatibility

inserts		page:
CDD	24 poles + ⊕	76
CDS	9 poles + ⊕	-
CDSH	9 poles + ⊕	86
CDSH NC	6 poles + ⊕	95
CNE	6 poles + ⊕	110
CSE	6 poles + ⊕	-
CSH	6 poles + ⊕	110
CSH S	6 poles + ⊕	122
CCE	6 poles + ⊕	130
CSS	6 poles + ⊕	148
CT, CTSE (16A) *	6 poles + ⊕	160
CQE	10 poles + ⊕	168
MIXO	2 modules	232 - 287

\*) only for enclosure CHIS 06 L

## housings and cover

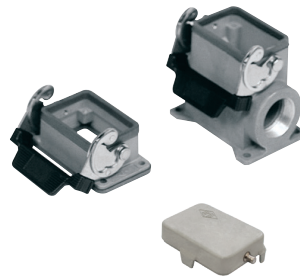

## hoods and cover



description	part No.	entry Pg	part No	entry M	part No.	entry Pg	part No.	entry M
bulkhead mounting housing with lever and gasket	<b>CHIS 06 L</b>	--						
surface mounting housing, with lever, high construction	<b>CAPS 06 L</b>	21	<b>MAPS 06 L32</b>	32				
cover with pegs (for 1 lever enclosures) 1)	<b>CHCS 06 L</b>							
enclosure with pegs, side entry, high construction, without adaptor *					<b>CFOS 06 L21</b>	21	<b>MFOS 06 L32</b>	32
enclosure with pegs, top entry, high construction, without adaptor *					<b>CFVS 06 L21</b>	21	<b>MFVS 06 L32</b>	32
cover with lever (for enclosures with pegs) 2)					<b>CHCS 06 LG</b>			

\* enclosure without adapter, threaded on the enclosure body, to be used only with a complete cable gland.

panel cut-out for bulkhead mounting housings

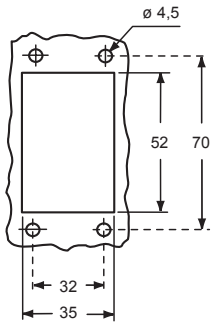

For fixing on housings

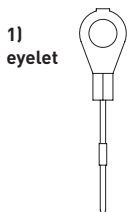

For fixing on hoods

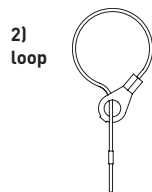

### CHIS L

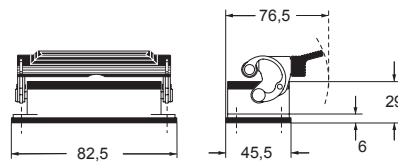

### CAPS L and MAPS L

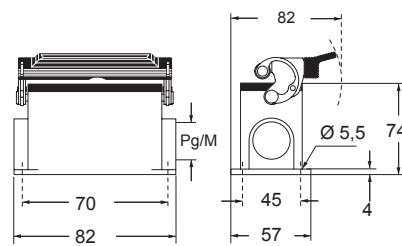

### CHCS L

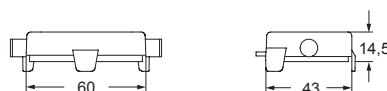

### CFOS L and MFOS L

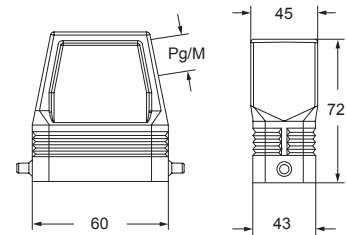

### CFVS L and MFVS L

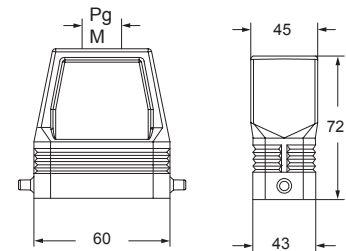

### CHCS LG

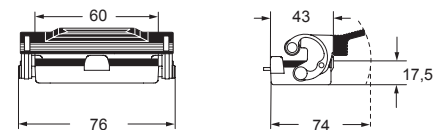

**CAVUS**® Type 4/4X/12





# CH - CA and MA EMC version for electromagnetic compatibility

inserts		page:
CDD	42 poles + ⊕	78
CDS	18 poles + ⊕	-
CDSH	18 poles + ⊕	87
CNE	10 poles + ⊕	111
CSE	10 poles + ⊕	-
CSH	10 poles + ⊕	111
CSH S	10 poles + ⊕	123
CCE	10 poles + ⊕	131
CMSH	3+2 (aux) poles + ⊕	136
CMCE	3+2 (aux) poles + ⊕	137
CSS	10 poles + ⊕	149
CT, CTSE (16A) *)	10 poles + ⊕	161
CQE	18 poles + ⊕	169
CX	8/24 poles + ⊕	194
MIXO	3 modules	232 - 287

\*) only for enclosure CHIS 10

## housings and cover

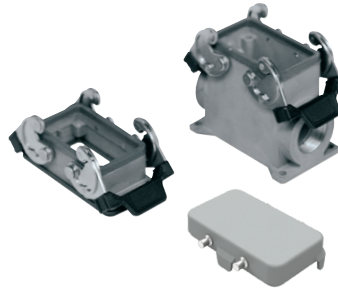

## hoods and cover



description	part No.	entry Pg	part No.	entry M	part No.	entry Pg	part No.	entry M
bulkhead mounting housing with levers and gasket	<b>CHIS 10</b>	--						
surface mounting housing, with levers, high construction	<b>CAPS 10.21</b>	21	<b>MAPS 10.32</b>	32				
cover with 4 pegs (for enclosures with 2 levers) 1)	<b>CHCS 10</b>							
enclosure with pegs, side entry, high construction					<b>CAOS 10.21</b>	21	<b>MAOS 10.32</b>	32
enclosure with pegs, top entry, high construction					<b>CAVS 10.21</b>	21	<b>MAVS 10.32</b>	32
cover with 2 levers (for enclosures with 4 pegs) 2)					<b>CHCS 10 G</b>			

panel cut-out for bulkhead mounting housings

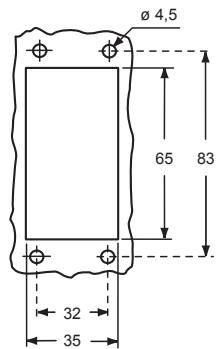

For fixing on housings

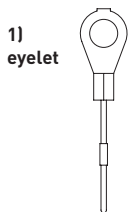

For fixing on hoods

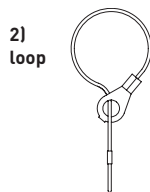

### CHIS

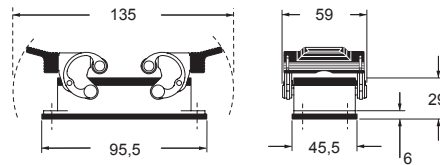

### CAPS and MAPS

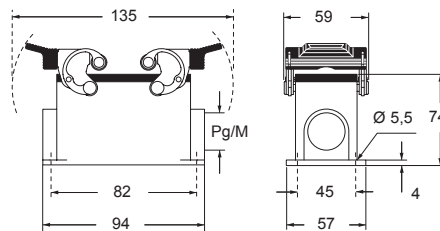

### CHCS

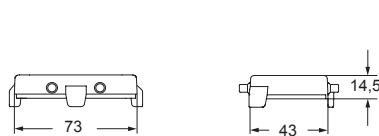

### CAOS and MAOS

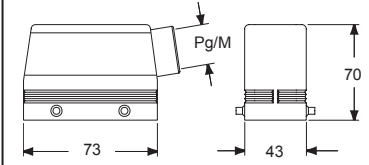

### CAVS and MAVS

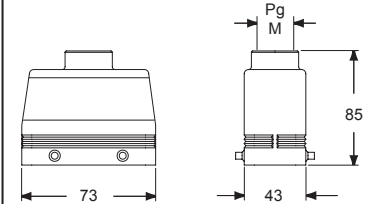

### CHCS G

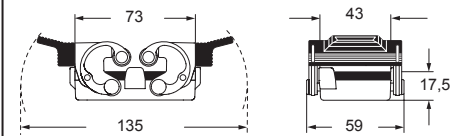

**CAUS**® Type 4/4X/12



# CH - CA and MH - MA EMC version for electromagnetic compatibility

inserts		page:
CD	40 poles + ⊕	70
CDD	72 poles + ⊕	79
CDS	27 poles + ⊕	-
CDSH	27 poles + ⊕	88
CNE	16 poles + ⊕	112
CSE	16 poles + ⊕	-
CSH	16 poles + ⊕	112
CSH S	16 poles + ⊕	124
CCE	16 poles + ⊕	132
CMSH, CMCE	6+2 (aux) poles + ⊕	138 - 139
CSS	16 poles + ⊕	150
CT, CTS (10A) *)	40 poles + ⊕	156
CT, CTSE (16A) *)	16 poles + ⊕	162
CQE	32 poles + ⊕	170
CQEE	40 poles + ⊕	176
CP	6 poles + ⊕	178
CX	6/12, 6/36 and 12/2 poles + ⊕	197 - 199
CX	4/0 and 4/2 poles + ⊕	200 - 201
MIXO	4 modules	232 - 287

\*) only for enclosure CHIS 16

## housings and cover

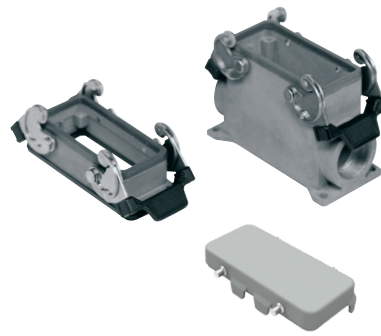

## hoods and cover



description	part No.	entry Pg	part No	entry M	part No.	entry Pg	part No.	entry M
bulkhead mounting housing with levers and gasket	<b>CHIS 16</b>	--						
surface mounting housing, with levers, high construction	<b>CAPS 16.21</b>	21	<b>MAPS 16.32</b>	32				
cover with 4 pegs (for enclosures with 2 levers) 1)	<b>CHCS 16</b>							
enclosure with pegs, side entry					<b>CHOS 16</b>	21	<b>MHOS 16.25</b>	25
enclosure with pegs, side entry							<b>MHOS 16.32</b>	32
enclosure with pegs, side entry, high construction					<b>CAOS 16.29</b>	29	<b>MAOS 16.32</b>	32
enclosure with pegs, side entry, high construction							<b>MAOS 16.40</b>	40
enclosure with pegs, top entry					<b>CHVS 16</b>	21	<b>MHVS 16.25</b>	25
enclosure with pegs, top entry							<b>MHVS 16.32</b>	32
enclosure with pegs, top entry, high construction					<b>CAVS 16.29</b>	29	<b>MAVS 16.32</b>	32
enclosure with pegs, top entry, high construction							<b>MAVS 16.40</b>	40
cover with 2 levers (for enclosures with 4 pegs) 2)	<b>CHCS 16 G</b>							

## panel cut-out for bulkhead mounting housings

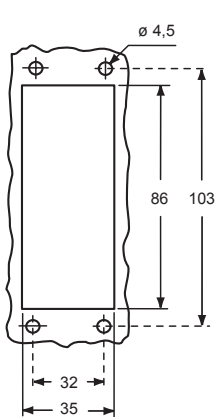

### For fixing on housings

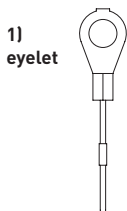

### For fixing on hoods

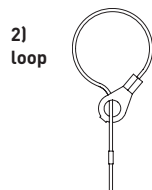

## CHIS

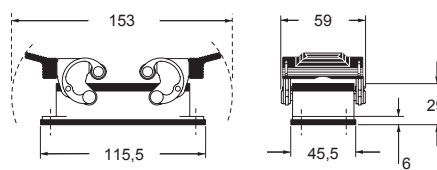

## CAPS and MAPS

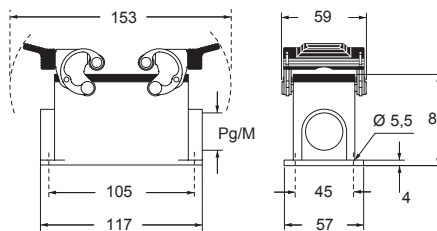

## CHCS

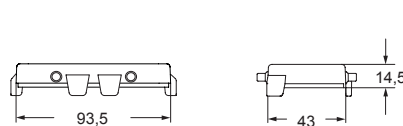

## CHOS (CAOS) and MHOS (MAOS)

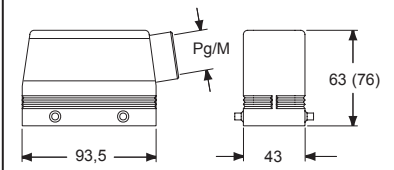

## CHVS (CAVS) and MHVS (MAVS)

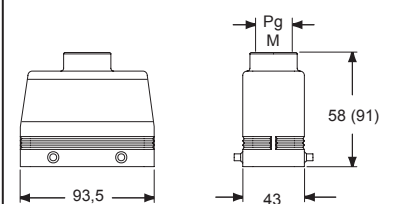

## CHCS G

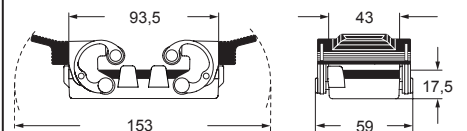

**CAIUS** Type 4/4X/12



# CH - CA and MH - MA EMC version for electromagnetic compatibility

inserts		page:
CD	64 poles + ⊕	72
CDD	108 poles + ⊕	81
CDS	42 poles + ⊕	-
CDSH	42 poles + ⊕	89
CNE	24 poles + ⊕	113
CSE	24 poles + ⊕	-
CSH	24 poles + ⊕	113
CSH S	24 poles + ⊕	125
CCE	24 poles + ⊕	133
CMSH	10+2 (aux) poles + ⊕	140
CMCE	10+2 (aux) poles + ⊕	141
CSS	24 poles + ⊕	151
CT, CTS (10A *)	64 poles + ⊕	157
CT, CTSE (16A *)	24 poles + ⊕	163
CQE	46 poles + ⊕	171
CQEE	64 poles + ⊕	177
CX	4/8 and 6/6 poles + ⊕	204 and 206
MIXO	6 modules	232 - 287

\*) only for enclosure CHIS 24



description	part No.	entry Pg	part No	entry M	part No.	entry Pg	part No.	entry M
bulkhead mounting housing with levers and gasket	<b>CHIS 24</b>	--						
surface mounting housing, with levers, high construction	<b>CAPS 24.21</b>	21	<b>MAPS 24.32</b>	32				
cover with 4 pegs (for enclosures with 2 levers) 1)	<b>CHCS 24</b>							
enclosure with pegs, side entry					<b>CHOS 24</b>	21	<b>MHOS 24.25</b>	25
enclosure with pegs, side entry							<b>MHOS 24.32</b>	32
enclosure with pegs, side entry, high construction					<b>CAOS 24.29</b>	29	<b>MAOS 24.32</b>	32
enclosure with pegs, side entry, high construction							<b>MAOS 24.40</b>	40
enclosure with pegs, top entry					<b>CHVS 24</b>	21	<b>MHVS 24.25</b>	25
enclosure with pegs, top entry							<b>MHVS 24.32</b>	32
enclosure with pegs, top entry, high construction					<b>CAVS 24.29</b>	29	<b>MAVS 24.32</b>	32
enclosure with pegs, top entry, high construction							<b>MAVS 24.40</b>	40
cover with 2 levers (for enclosures with 4 pegs) 2)	<b>CHCS 24 G</b>							

panel cut-out for bulkhead mounting housings

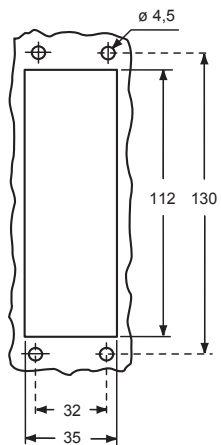

For fixing on housings

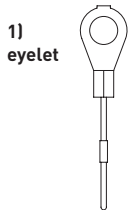

For fixing on hoods

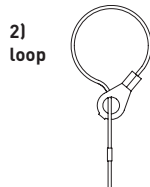

CHIS

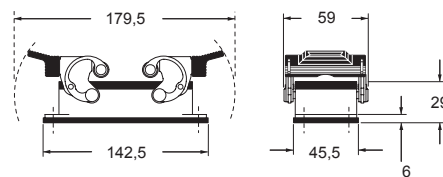

CAPS and MAPS

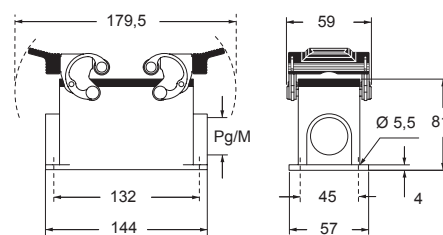

CHCS

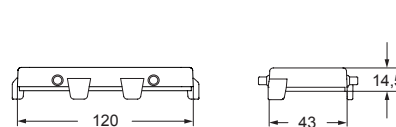

CHOS (CAOS) and MHOS (MAOS)

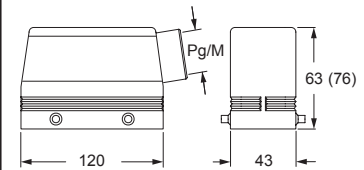

CHVS (CAVS) and MHVS (MAVS)

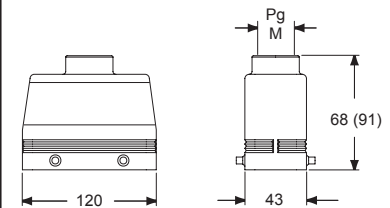

CHCS G

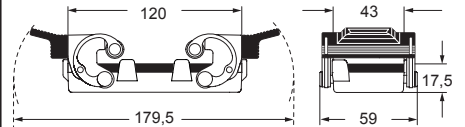

**CAUS** Type 4/4X/12



## 180 °C

### The heat shield

Series specifically developed for industrial applications where the ambient temperatures are particularly harsh (from -40°C to +180°C).

Available in the sizes "21.21", "44.27", "57.27", "77.27", "104.27" and "104.62", to be used in combination with the available connector inserts suitable for high temperatures up to **180 °C** made by self-extinguishing thermoplastic material (>PPS< polyphenylene sulphide).

All these enclosures except those sized "21.21" have supplementary insulating strips inside.

This enclosure series is distinguished by the red colour.

cULus certified for USA and Canada for **Type 12** (indoor use), **Type 4** and **Type 4X** (outdoor use) (equivalent to NEMA 12, 4, and 4X and ) protection ratings, marked on the packaging label.

**IP44** (size "21.21"), **IP65** (other sizes) degree of protection according to **EN IEC 60529**.

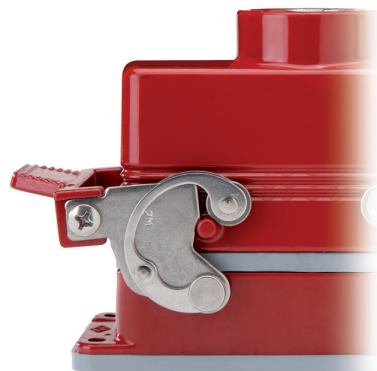

#### SUM-UP OF MATERIALS USED

- enclosure body made of die cast aluminium alloy;
- chromate conversion coating, RoHS 2 conform, on the enclosure body die casts;
- coated with special high temperatures resistant, red coloured thermosetting powder;
- flange and interface sealing gaskets (as applicable) in FPK, anti-aging heat resistant fluoroelastomer;
- locking device with lever(s), springs and pegs in stainless steel;
- single-block locking lever handles in stainless steel (for "21.21" sized CKA...R/ MKA...R, "44.16" sized CZ...R and MZ...R, and "104.62" sized CH...R 48 ... and, MH...R 48 ... versions);
- locking lever handles in die-cast aluminium alloy with the same special coating as the enclosure body (for CH...R 10, 16, 24 and MH...R 10, 16, 24 versions).

# CKA and MKA 180 °C version

inserts		page:
CK RY	3 poles + ⊕	60
CK RY	4 poles + ⊕	60

## bulkhead mounting housings straight and angled



## hoods

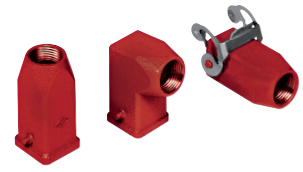

1) Enclosures with IP44 protection rating

description	part No. (entry - Pg11)	part No. (entry - M20)	part No. (entry - Pg11)	part No. (entry - M20)
with stainless steel lever and gasket <sup>1)</sup>	<b>CKAXR 03 I</b>			
without cable entry, with stainless steel lever and gasket <sup>1)</sup>	<b>CKAXR 03 IA</b>			
with cable entry, with stainless steel lever and gasket <sup>1)</sup>	<b>CKAXR 03 IAP</b>	<b>MKAXR IAP20</b>		
with cable entry, with stainless steel lever and gasket bulkhead hole closed <sup>1)</sup>	<b>CKAXR 03 AP</b>	<b>MKAXR AP20</b>		
with pegs, top entry <sup>1)</sup>			<b>CKAR 03 V</b>	<b>MKAR V20</b>
with pegs, side entry <sup>1)</sup>			<b>CKAR 03 VA</b>	<b>MKAR VA20</b>
with stainless steel lever, top entry <sup>1)</sup>			<b>CKAXR 03 VG</b>	<b>MKAXR VG20</b>

1) Enclosures with IP44 protection rating

panel cut-out for bulkhead mounting housings

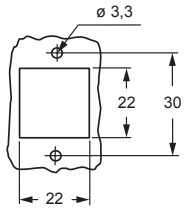

### CKAXR I

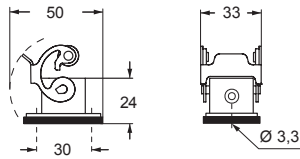

### CKAXR IA

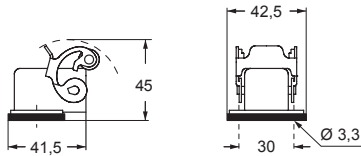

### CKAXR IAP (CKAXR AP) and MKAXR IAP (MKAXR AP)

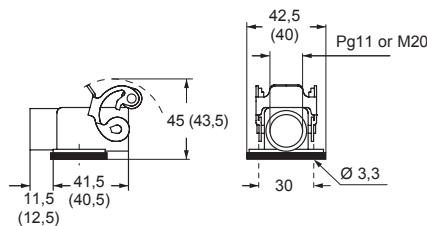

### CKAR V and MKAR V

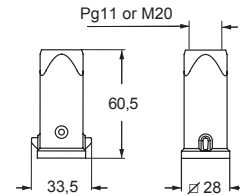

### CKAR VA and MKAR VA

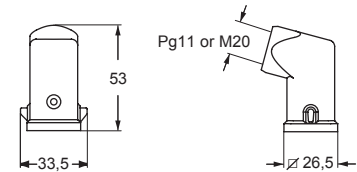

### CKAXR VG and MKAXR

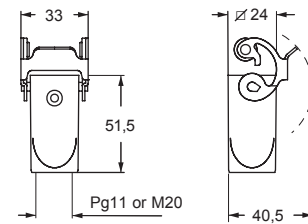

**CAUS** Type 12



# MKAX 180 °C version

inserts		page:
CK RY	3 poles + ⊕	60
CK RY	4 poles + ⊕	60

## bulkhead mounting housings with stainless steel lever



AVAILABLE MAY 2019

description	part No. (entry - M32)
-------------	---------------------------

M32 fixing thread <sup>(*)</sup>	MKAXR IF
----------------------------------	----------

<sup>(\*)</sup> Locknut supplied on request, see Cable glands catalogue (article AS M32N metallic)

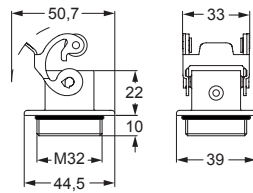
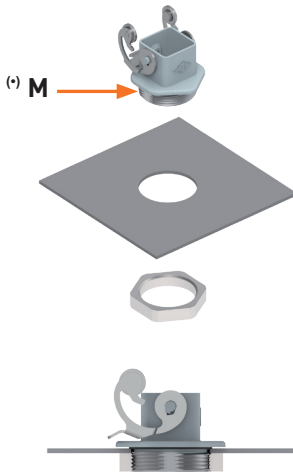

panel cut-out for enclosures

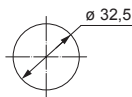

NOTE: Lever type and housing colour may vary upon specific part No.

cURus  
Type 12 pending



180 °C



# MKAXX 180 °C version

<b>inserts</b>		<b>page:</b>
CK RY	3 poles + ⊕	60
CK RY	4 poles + ⊕	60

## bulkhead mounting housings with stainless steel rigid lever



**AVAILABLE MAY 2019**

<b>description</b>	<b>part No.</b> (entry - M32)
--------------------	----------------------------------

M32 fixing thread <sup>(*)</sup>	<b>MKAXXR IF</b>
----------------------------------	------------------

<sup>(\*)</sup> Locknut supplied on request, see Cable glands catalogue (article AS M32N metallic)

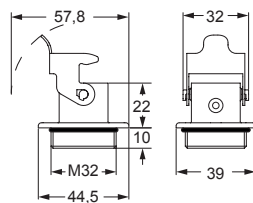
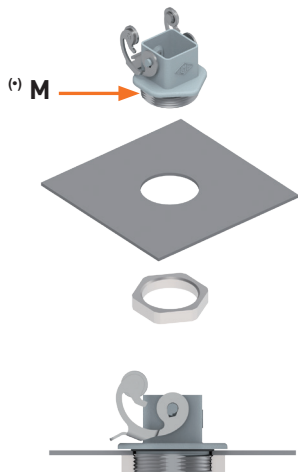

panel cut-out for enclosures

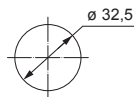

**NOTE:** Lever type and housing colour may vary upon specific part No.

cURus  
Type 12 pending



inserts  
**CNE RY** 6 poles + ⊕ page: 116

**bulkhead and surface mounting housings and cover**

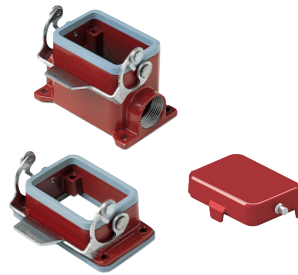

**hoods and cover**



description	part No.	entry Pg	part No.	entry M	part No.	entry Pg	part No.	entry M
bulkhead mounting housing with lever and gasket	<b>CZIR 06 L</b>	--						
surface mounting housing, with lever	<b>CZPR 06 L</b>	16	<b>MZPR 06 L20</b>	20				
surface mounting housing, with lever, high construction	<b>CZAPR 06 L</b>	21	<b>MZAPR 06 L32</b>	32				
cover with pegs (for enclosures) 1)	<b>CHCR 06 L</b>							
enclosure with pegs, side entry					<b>CHOR 06 L13</b>	13.5	<b>MHOR 06 L20</b>	20
enclosure with pegs, top entry, high construction					<b>CAOR 06 L21</b>	21	<b>MAOR 06 L32</b>	32
enclosure with pegs, top entry					<b>CHVR 06 L13</b>	13.5	<b>MHVR 06 L20</b>	20
enclosure with pegs, top entry, high construction					<b>CAVR 06 L21</b>	21	<b>MAVR 06 L32</b>	32
cover with lever (for hoods) 2)	<b>CZCR 06 LG</b>							

panel cut-out for bulkhead mounting housings

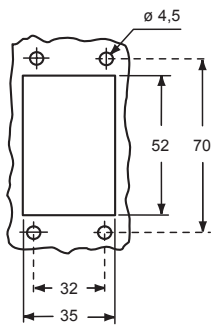

For fixing on housings

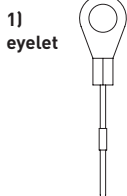

For fixing on hoods

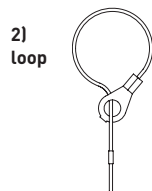

**CZIR L**

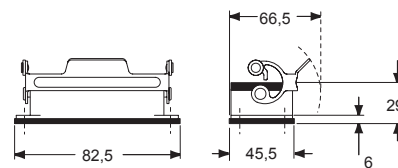

**CZPR L - CZAPR L and MZPR L - MZAPR L**

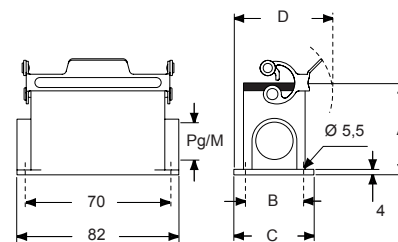

type	A	B	C	D
<b>CZPR L / MZPR L</b>	53	40	52	69,5
<b>CZAPR L / MZAPR L</b>	74	45	57	72

**CHCR L**

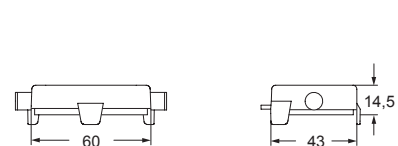

**CHOR L (CAOR L) and MHOR L (MAOR L)**

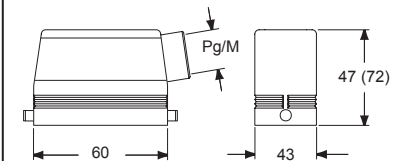

**CHVR L (CAVR L) and MHVR L (MAVR L)**

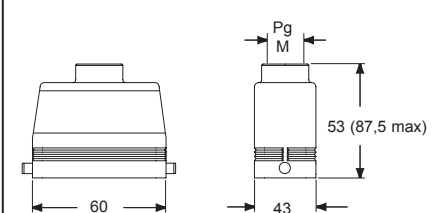

**CZCR LG**

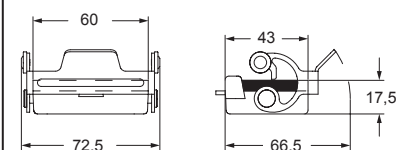

**CAIUS** Type 4/4X/12



180 °C

# CH - CA and MH - MA 180 °C version

inserts  
**CNE RY** 10 poles + ⊕ page: 117

## bulkhead and surface mounting housings and cover

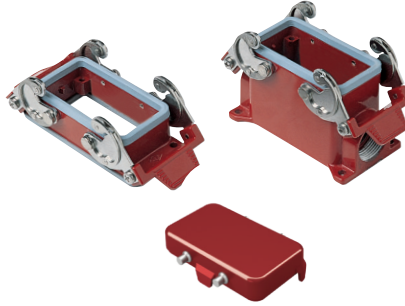

## hoods and cover

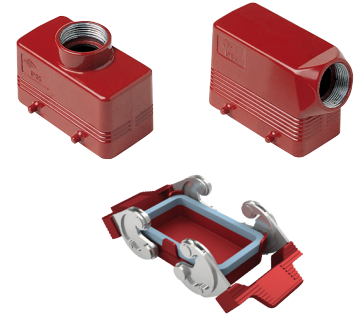

description	part No.	entry Pg	part No.	entry M	part No.	entry Pg	part No.	entry M
bulkhead mounting housing with levers and gasket	<b>CHIR 10</b>	–						
surface mounting housing, with levers	<b>CHPR 10</b>	16	<b>MHPR 10.20</b>	20				
surface mounting housing, with levers, high construction	<b>CAPR 10.21</b>	21	<b>MAPR 10.32</b>	32				
cover with 4 pegs (for enclosures) 1)	<b>CHCR 10</b>							
enclosure with pegs, side entry					<b>CHOR 10</b>	16	<b>MHOR 10.20</b>	20
enclosure with pegs, side entry, high construction					<b>CAOR 10.21</b>	21	<b>MAOR 10.32</b>	32
enclosure with pegs, top entry					<b>CHVR 10</b>	16	<b>MHVR 10.20</b> **	20
enclosure with pegs, top entry, high construction					<b>CAVR 10.21</b>	21	<b>MAVR 10.32</b>	32
cover with 2 levers (for hoods) 2)					<b>CHCR 10 G</b>			

panel cut-out for bulkhead mounting housings

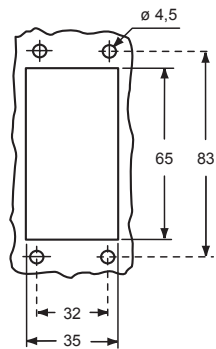

For fixing on housings

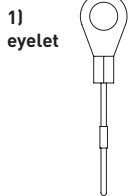

For fixing on hoods

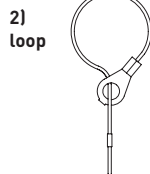

### CHIR

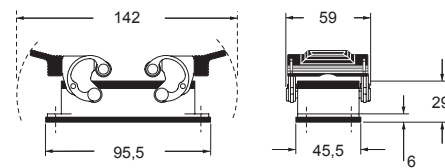

### CHPR - CAPR and MHPR - MAPR

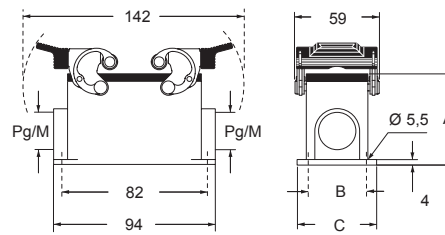

type	A	B	C
CHPR / MHPR	57	40	52
CAPR / MAPR	74	45	57

### CHCR

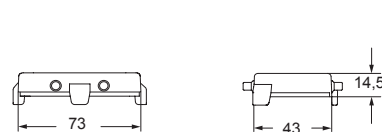

\*\* can only be used with a complete cable gland (to be purchased separately)

### CHOR (CAOR) and MHOR (MAOR)

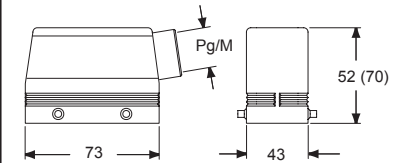

### CHVR (CAVR) and MHVR (MAVR)

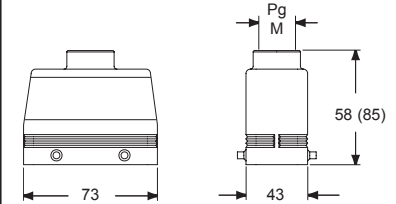

### CHCR G

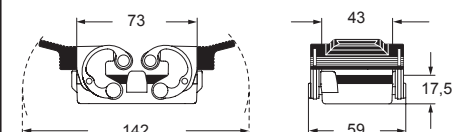

**CAUS** Type 4/4X/12



# CH - CA and MH - MA 180 °C version

inserts		page:
CNE RY	16 poles + ⊕	118
CP RY	6 poles + ⊕	178
CX RY	4/0 and 4/2 poles + ⊕	202 - 203

## bulkhead and surface mounting housings and cover

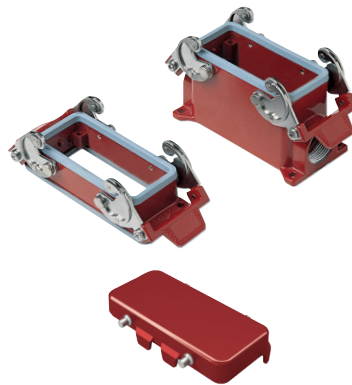

## hoods and cover

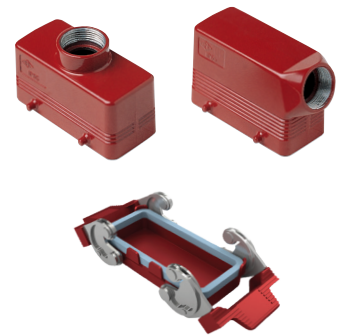

description	part No.		part No.		part No.		part No.	
	entry Pg	entry M	entry Pg	entry M	entry Pg	entry M	entry Pg	entry M
bulkhead mounting housing with levers and gasket			<b>CHIR 16</b>	--				
surface mounting housing, with levers, high construction			<b>CAPR 16.21</b>	21	<b>MAPR 16.32</b>	32		
cover with 4 pegs (for enclosures 1)			<b>CHCR 16</b>					
enclosure with pegs, side entry					<b>CHOR 16</b>	21	<b>MHOR 16.25</b>	25
enclosure with pegs, side entry, high construction					<b>CAOR 16.21</b>	21	<b>MAOR 16.40</b>	40
enclosure with pegs, top entry					<b>CHVR 16</b>	21	<b>MHVR 16.25</b>	25
enclosure with pegs, top entry, high construction					<b>CAVR 16.21</b>	21	<b>MAVR 16.40</b>	40
cover with 2 levers (for hoods 2)					<b>CHCR 16 G</b>			

### panel cut-out for bulkhead mounting housings

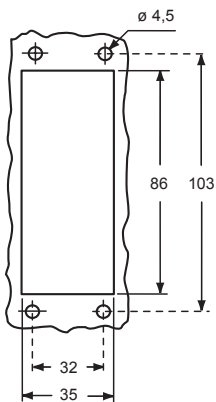

### For fixing on housings

1) eyelet

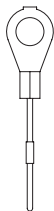

### For fixing on hoods

2) loop

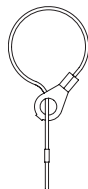

### CHIR

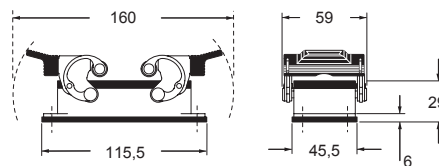

### CAPR and MAPR

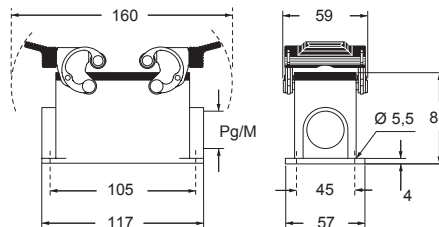

### CHCR

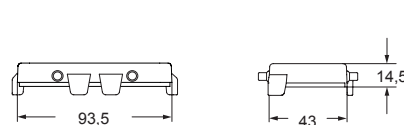

### CHOR (CAOR) and MHOR (MAOR)

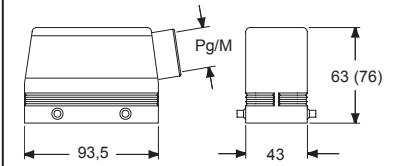

### CHVR (CAVR) and MHVR (MAVR)

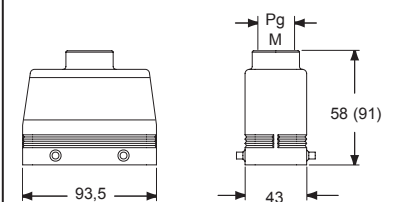

### CHCR G

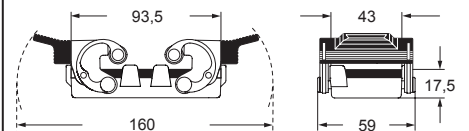

**CAUS**® Type 4/4X/12



# CH - CA and MH - MA 180 °C version

inserts		page:
CNE RY	24 poles + ⊕	119
CX RY	4/8 poles + ⊕	204

## bulkhead and surface mounting housings and cover

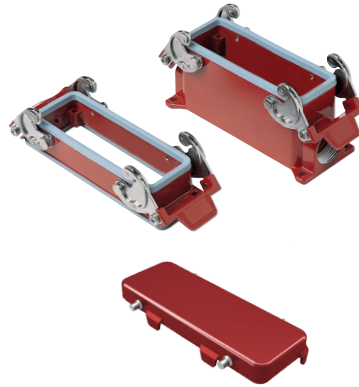

## hoods and cover

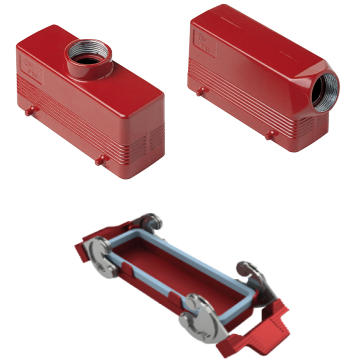

description	part No.	entry Pg	part No.	entry M	part No.	entry Pg	part No.	entry M
bulkhead mounting housing with levers and gasket	<b>CHIR 24</b>	--						
surface mounting housing, with levers, high construction cover with 4 pegs (for enclosures) 1)	<b>CAPR 24.21</b>	21	<b>MAPR 24.32</b>	32				
cover with 4 pegs (for enclosures) 1)	<b>CHCR 24</b>							
enclosure with pegs, side entry					<b>CHOR 24</b>	21	<b>MHOR 24.25</b>	25
enclosure with pegs, side entry, high construction					<b>CAOR 24.29</b>	29	<b>MAOR 24.40</b>	40
enclosure with pegs, top entry					<b>CHVR 24</b>	21	<b>MHVR 24.25</b>	25
enclosure with pegs, top entry, high construction					<b>CAVR 24.29</b>	29	<b>MAVR 24.40</b>	40
cover with 2 levers (for hoods) 2)					<b>CHCR 24 G</b>			

### panel cut-out for bulkhead mounting housings

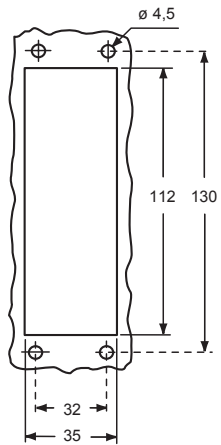

### For fixing on housings

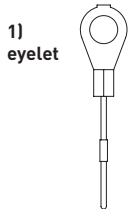

### For fixing on hoods

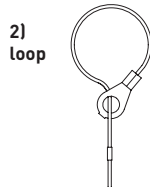

### CHIR

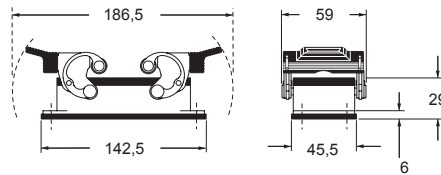

### CAPR and MAPR

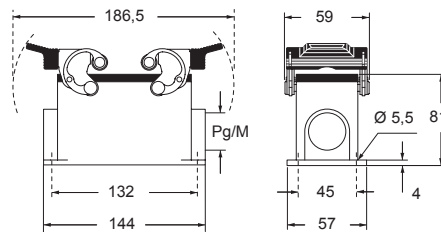

### CHCR

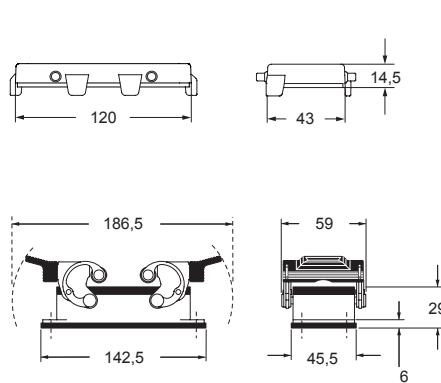

### CHOR (CAOR) and MHOR (MAOR)

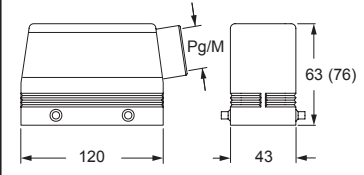

### CHVR (CAVR) and MHVR (MAVR)

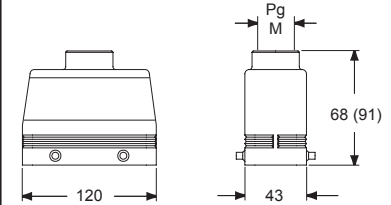

### CHCR G

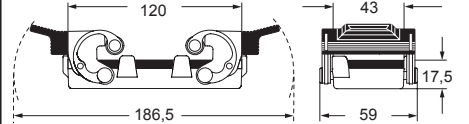

**CAUS** Type 4/4X/12



# CH and MH 180 °C version

inserts page:  
**CNE RY** 48 poles + ⊕ **120**  
 insert dimensions:  
**2 x (104 x 27) mm**

## bulkhead and surface mounting housings

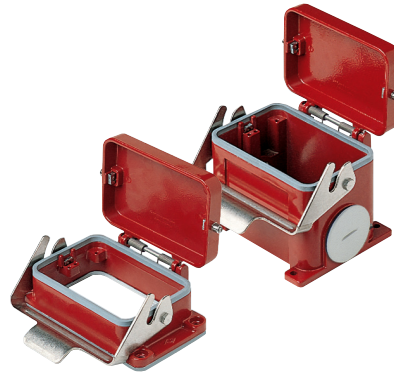

## hoods



description	part No.	entry Pg	part No.	entry M	part No.	entry Pg	part No.	entry M
bulkhead mounting housings, with lever and cover	<b>CHIR 48 LS</b>	--						
surface mounting housings, with lever and cover	<b>CHPR 48 LS</b>	36 x 1/2	<b>MHPR 48 LS40</b>	40 x 1/2				
side entry, with pegs					<b>CHOR 48 L</b>	36	<b>MHOR 48 L40</b>	40
top entry, with pegs					<b>CHVR 48 L</b>	36	<b>MHVR 48 L40</b>	40

panel cut-out for bulkhead mounting housings

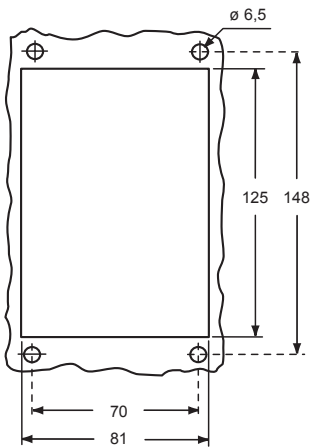

### CHIR LS

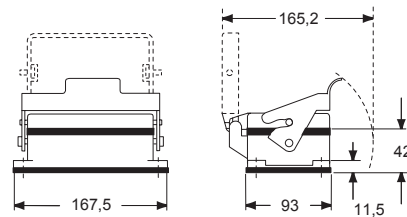

### CHPR LS and MHPR LS

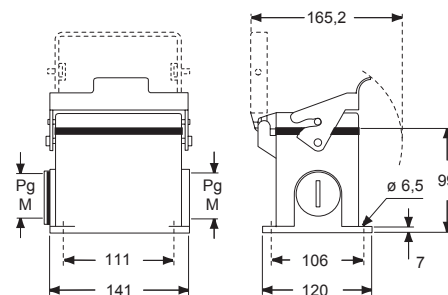

### CHOR L and MHOR L

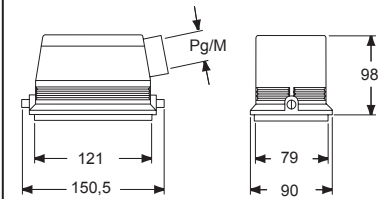

### CHVR L and MHVR L

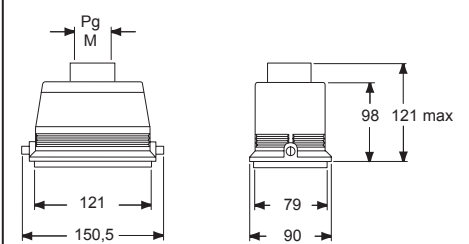

**CAUS**® Type 4/4X/12



180 °C



## HNM series

### In and out

**Housings** (bulkhead-mount or surface mount) equipped with **V-TYPE single locking lever** with special **anti-friction treatment**

*to be mated to*

**Hoods** with **riveted anti-friction pegs**, that facilitate the frequent opening and closing.

This **HNM** series of connector enclosures has been developed to be used in combination with the **HNM** series of multipole connector inserts equipped with relevant **HNM** series of removable crimp contacts, to provide the same reliable protection of the standard series but for a consistently extended, **high number of matings**.

When the number of 500 mating cycles guaranteed life of standard connector hoods and housings is insufficient to provide a reasonably long life span in those connector applications that by function are foreseen to be subject to very frequent connections and disconnections, it is necessary to opt for a solution able to increase that guaranteed lifetime.

The **HNM** series of connector enclosures achieves this goal, extending the guaranteed number of matings up to 10 000.

The locking means, comprising both the locking lever and locking pegs are chosen and treated so as to reduce wear due to friction at minimum, thanks to the use of the clever proprietary design of the **V-TYPE locking lever**, that already in standard enclosures is able to provide extremely reduced wear on the corresponding locking pegs, producing a very limited friction, furtherly reduced by the application of a special anti-friction lubrication treatment.

The counterpart hoods for locking on the long side are already provided by riveted anti-friction rolling pegs, as well furtherly improved by the special anti-friction lubrication treatment.



# RV - RVA HNM (High Number of Matings)

inserts		page:
RDD	24 poles + ⊕	210
RCE	6 poles + ⊕	214
MIXO HNM	2 modules	291 - 303

bulkhead mounting housings  
with single lever in stainless steel



**Q 10.000 MATINGS WITH HNM INSERTS**

surface mounting housings  
with single lever in stainless steel



**Q 10.000 MATINGS WITH HNM INSERTS**

description	part No.	part No.	entry M
with lever and gasket, size "44.27"	<b>RVI 06 L</b>		
with lever, size "44.27"		<b>RVP 06 L20</b>	20
with lever, size "44.27"		<b>RVP 06 L220</b>	20 x 2
with lever, high construction, size "44.27"		<b>RVAP 06 L32</b>	32
with lever, high construction, size "44.27"		<b>RVAP 06 L232</b>	32 x 2

panel cut-out for bulkhead mounting housings

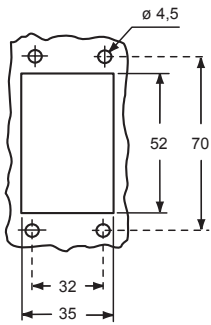

**RVI L**

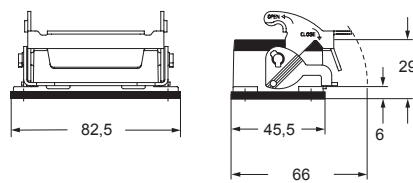

**RVP L - RVAP L**

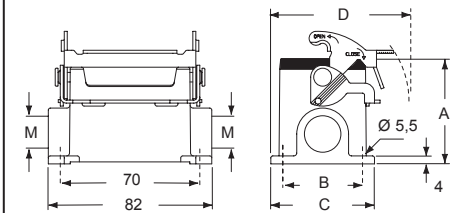

type	A	B	C	D
<b>RVP 06 L</b>	53	40	52	70
<b>RVAP 06 L</b>	74	45	57	72,5

IP degrees are according to the type of lever and:



cable gland  
without O-Ring gasket



cable gland  
equipped with O-Ring gasket

HNM

# RH - RF HNM (High Number of Matings)

inserts		page:
RDD	24 poles + ⊕	210
RCE	6 poles + ⊕	214
MIXO HNM	2 modules	291 - 303

## hoods with 2 pegs



**Q 10.000 MATINGS WITH HNM INSERTS**

## hoods with 2 pegs



**Q 10.000 MATINGS WITH HNM INSERTS**

description	part No.	entry M	part No.	entry M
with pegs, side entry	<b>RHO 06 L25</b>	25	<b>RFO 06 L32</b>	32
with pegs, top entry	<b>RHV 06 L25</b> <sup>1)</sup>	25	<b>RFV 06 L32</b>	32
with pegs, side entry, high construction, without adapter *				
with pegs, top entry, high construction, without adapter *				

\* enclosure without adapter, threaded on the body, to be used only with a complete cable gland.

<sup>1)</sup> cannot be used with MIXO series

### RHO L

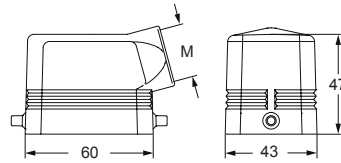

### RFO L

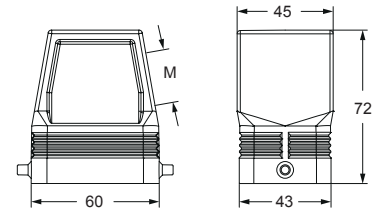

### RHV L

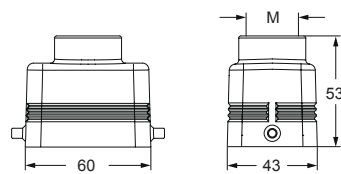

### RFV L

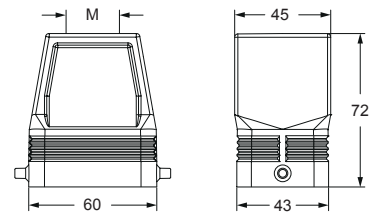

IP degrees are according to the type of lever and:



cable gland without O-Ring gasket



cable gland equipped with O-Ring gasket  
IP67 if hoods with fused pegs and without adapters coupled with IP67 housings

# RV - RVA HNM (High Number of Matings)

inserts		page:
RDD	42 poles + ⊕	211
RCE	10 poles + ⊕	215
MIXO HNM	3 modules	291 - 303

bulkhead mounting housings  
with single lever in stainless steel



**Q 10.000 MATINGS WITH HNM INSERTS**

surface mounting housings  
with single lever in stainless steel

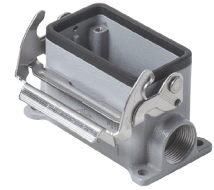

**Q 10.000 MATINGS WITH HNM INSERTS**

description	part No.	part No.	entry M
with lever, size "57.27"	<b>RV10 L</b>	<b>RVP 10 L20</b>	20
with lever, size "57.27"		<b>RVP 10 L220</b>	20 x 2
with lever, size "57.27"		<b>RVAP 10 L32</b>	32
with lever, high construction, size "57.27"		<b>RVAP 10 L232</b>	32 x 2

panel cut-out for bulkhead mounting housings

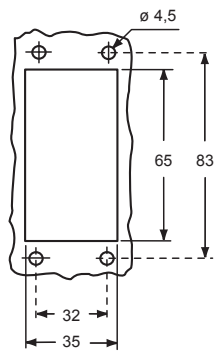

**RV10 L**

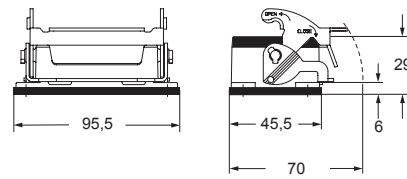

**RVP L - RVAP L**

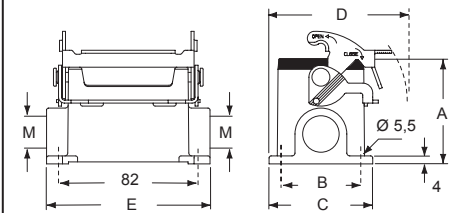

type	A	B	C	D	E
<b>RVP 10 L</b>	57	40	52	73	93,5
<b>RVAP 10 L</b>	74	45	57	75,5	94

IP degrees are according to the type of lever and:

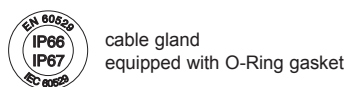
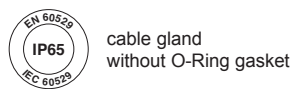

# RH - RF HNM (High Number of Matings)

inserts		page:
RDD	42 poles + ⊕	211
RCE	10 poles + ⊕	215
MIXO HNM	3 modules	291 - 303

## hoods with 2 pegs



**Q 10.000 MATINGS WITH HNM INSERTS**

## hoods with 2 pegs



**Q 10.000 MATINGS WITH HNM INSERTS**

description	part No.	entry M	part No.	entry M
with pegs, side entry	<b>RHO 10 L25</b>	25	<b>RFO 10 L32</b>	32
with pegs, top entry	<b>RHV 10 L25</b>	25	<b>RFV 10 L32</b>	32
with pegs, side entry, high construction, without adapter *				
with pegs, top entry, high construction, without adapter *				

\* enclosure without adapter, threaded on the body, to be used only with a complete cable gland.

### RHO L

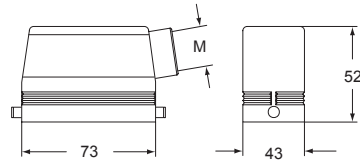

### RHV L

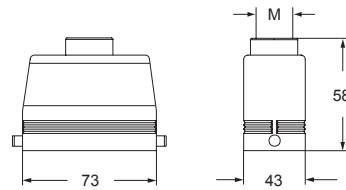

### RFO L

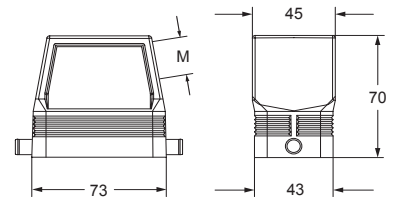

### RFV L

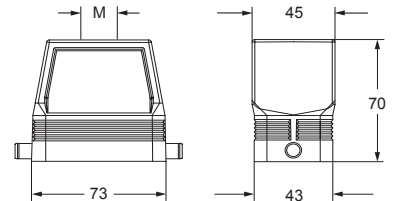

IP degrees are according to the type of lever and:

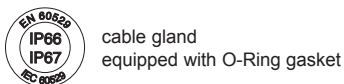
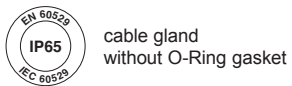

# RV - RVA HNM (High Number of Matings)

inserts		page:
RD	40 poles + ⊕	208
RDD	72 poles + ⊕	212
RCE	16 poles + ⊕	216
RQEE	40 poles + ⊕	218
RX	12 poles + 2 poles + ⊕	221
MIXO HNM	4 modules	291 - 303

**bulkhead mounting housings  
with single lever in stainless steel**

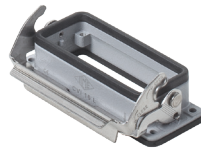

**Q 10.000 MATINGS WITH HNM  
INSERTS**

**surface mounting housings  
with single lever in stainless steel**



**Q 10.000 MATINGS WITH HNM  
INSERTS**

description	part No.	part No.	entry M
with lever, size "77.27"	<b>RVI 16 L</b>		
with lever, size "77.27"		<b>RVP 16 L25</b>	25
with lever, size "77.27"		<b>RVP 16 L225</b>	25 x 2
with lever, high construction, size "77.27"		<b>RVAP 16 L32</b>	32
with lever, high construction, size "77.27"		<b>RVAP 16 L232</b>	32 x 2

panel cut-out for bulkhead mounting housings

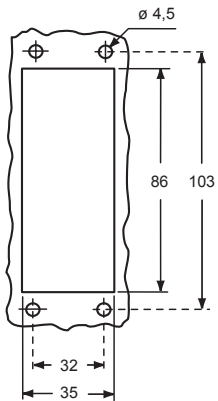

**RVI L**

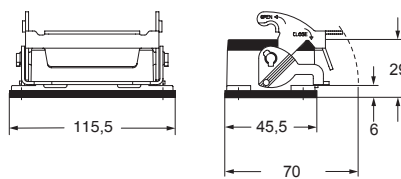

**RVP L - RVAP L**

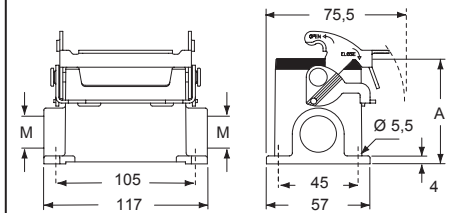

type	A
<b>RVP 16 L</b>	63
<b>RVAP 16 L</b>	81

IP degrees are according to the type of lever and:



cable gland  
without O-Ring gasket



cable gland  
equipped with O-Ring gasket



# RH - RF HNM (High Number of Matings)

<b>inserts</b>		<b>page:</b>
RD	40 poles + ⊕	208
RDD	72 poles + ⊕	212
RCE	16 poles + ⊕	216
RQEE	40 poles + ⊕	218
RX	12 poles + 2 poles + ⊕	221
MIXO HNM	4 modules	291 - 303

## hoods with 2 pegs

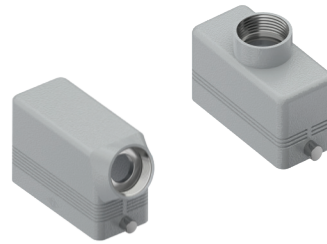

**Q 10.000 MATINGS WITH HNM INSERTS**

## hoods with 2 pegs



**Q 10.000 MATINGS WITH HNM INSERTS**

description	part No.	entry M	part No.	entry M
with pegs, side entry	<b>RHO 16 L32</b>	32	<b>RFO 16 L32</b>	32
with pegs, top entry	<b>RHV 16 L32</b>	32	<b>RFV 16 L32</b>	32
with pegs, side entry, high construction, without adapter *				
with pegs, top entry, high construction, without adapter *				

\* enclosure without adapter, threaded on the body, to be used only with a complete cable gland.

### RHO L

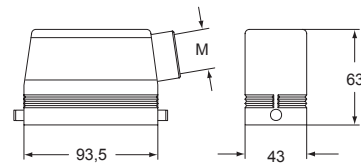

### RHV L

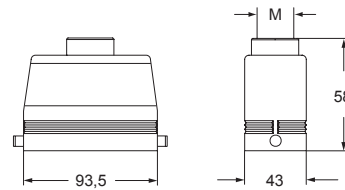

### RFO L

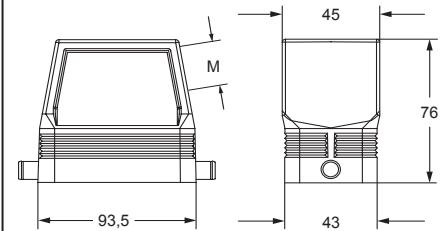

### RFV L

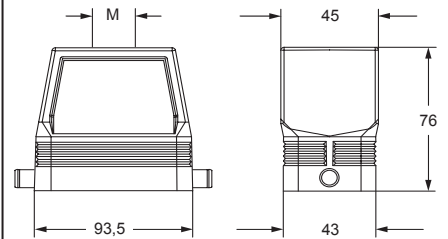

IP degrees are according to the type of lever and:

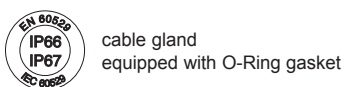
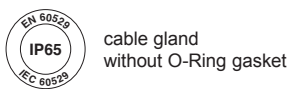

# RV - RVA HNM (High Number of Matings)

inserts		page:
RD	64 poles + ⊕	209
RDD	108 poles + ⊕	213
RCE	24 poles + ⊕	217
RQEE	64 poles + ⊕	219
MIXO HNM	6 modules	291 - 303

## bulkhead mounting housings with single lever in stainless steel



**Q 10.000 MATINGS WITH HNM INSERTS**

## surface mounting housings with single lever in stainless steel

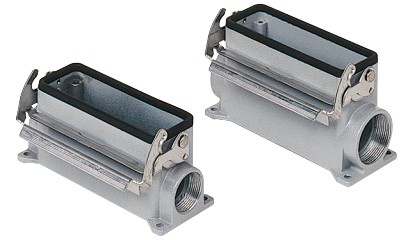

**Q 10.000 MATINGS WITH HNM INSERTS**

description	part No.	part No.	entry M
with lever, size "104.27"	<b>RVI 24 L</b>		
with lever, size "104.27"		<b>RVP 24 L25</b>	25
with lever, size "104.27"		<b>RVP 24 L225</b>	25 x 2
with lever, high construction, size "104.27"		<b>RVAP 24 L32</b>	32
with lever, high construction, size "104.27"		<b>RVAP 24 L232</b>	32 x 2

panel cut-out for bulkhead mounting housings

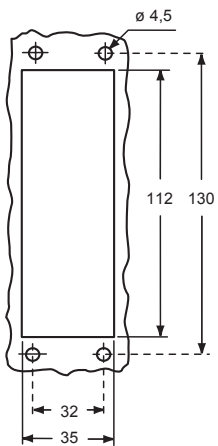

**RVI L**

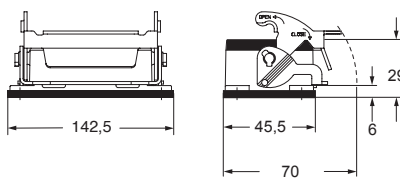

**RVP L - RVAP L**

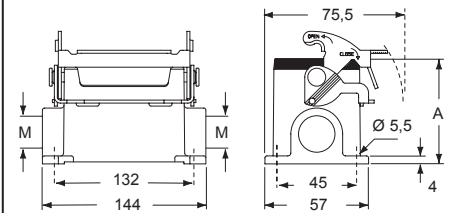

type	A
<b>RVP 24 L</b>	63
<b>RVAP 24 L</b>	81

IP degrees are according to the type of lever and:



cable gland without O-Ring gasket



cable gland equipped with O-Ring gasket

# RH - RF HNM (High Number of Matings)

inserts		page:
RD	64 poles + ⊕	209
RDD	108 poles + ⊕	213
RCE	24 poles + ⊕	217
RQEE	64 poles + ⊕	219
MIXO HNM	6 modules	291 - 303

## hoods with 2 pegs

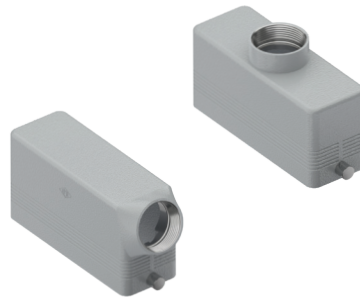

**Q 10.000 MATINGS WITH HNM INSERTS**

## hoods with 2 pegs



**Q 10.000 MATINGS WITH HNM INSERTS**

description	part No.	entry M	part No.	entry M
with pegs, side entry	<b>RHO 24 L32</b>	32	<b>RFO 24 L40</b>	40
with pegs, top entry	<b>RHV 24 L32</b>	32	<b>RFV 24 L40</b>	40
with pegs, side entry, high construction, without adapter *				
with pegs, top entry, high construction, without adapter *				

\* enclosure without adapter, threaded on the body, to be used only with a complete cable gland.

### RHO L

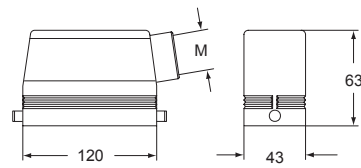

### RFO L

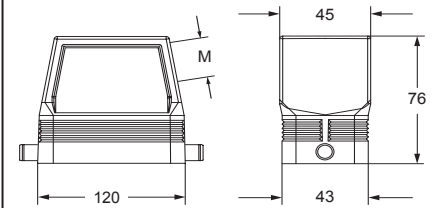

### RHV L

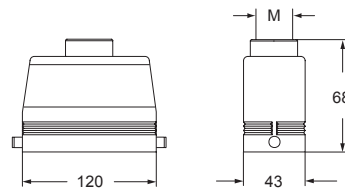

### RFV L

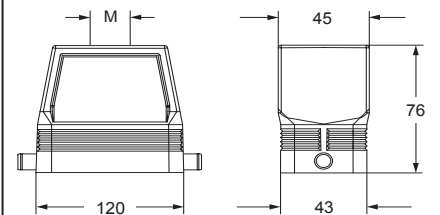

IP degrees are according to the type of lever and:



cable gland without O-Ring gasket



cable gland equipped with O-Ring gasket

# RAC dummy hoods HNM (High Number of Matings)

enclosures

- size "44.27"
- size "57.27"
- size "77.27"
- size "104.27"

page:

- 592 - 593
- 594 - 595
- 596 - 597
- 598 - 599

hoods without entry, to be pierced

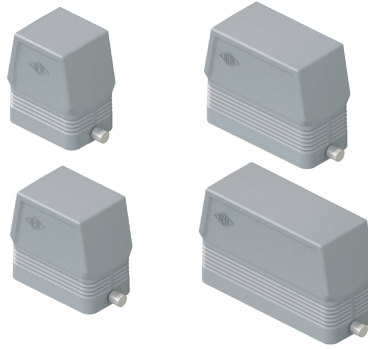

**Q 10.000 MATINGS WITH HNM INSERTS**

description

part No.  
with 2 pegs

with pegs for levers  
used with enclosures size "44.27"  
used with enclosures size "57.27"  
used with enclosures size "77.27"  
used with enclosures size "104.27"

- RAC 06 L**
- RAC 10 L**
- RAC 16 L**
- RAC 24 L**

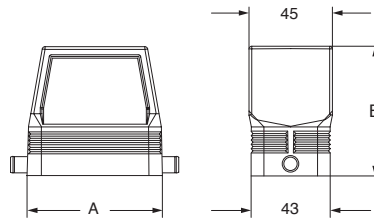

part No.	A	B
<b>RAC 06 L</b>	60	72
<b>RAC 10 L</b>	73	70
<b>RAC 16 L</b>	93,5	76
<b>RAC 16 L</b>	120	76

IP degrees are according to the type of lever and:



cable gland  
without O-Ring gasket



cable gland  
equipped with O-Ring gasket

**Caution:**  
As the frames are floating, **the PE earthing connection of the metal surfaces on which they are mounted (mounting bases) must be performed separately** and cannot be done by connecting the PE earthing contact to the corresponding connector inserts.

**Note:**  
The supply includes 1 frame and 4 shoulder screws with cylindrical head and notch to fix the frame in place.

For use with MIXO inserts CX 04 X, please contact ILME S.p.A.

## self-centering floating frame

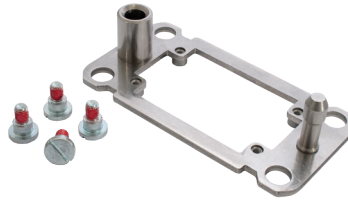

**Q 10.000 MATINGS WITH HNM INSERTS**

description	part No.
-------------	----------

in stainless steel, to be mounted on:  
 inserts size "44.27" \* and MIXO frames for 2 inserts  
 inserts size "57.27" \* and MIXO frames for 3 inserts  
 inserts size "77.27" \* and MIXO frames for 4 inserts  
 inserts size "104.27" \* and MIXO frames for 6 inserts

**CR 06 DF**  
**CR 10 DF**  
**CR 16 DF**  
**CR 24 DF**

\* Except CT, CTS and CTSE

### Technical specifications

- materials
  - floating frame, inserts: stainless steel
  - fixing screws: zinc-plated steel
- mechanical endurance:  $\geq 500$  cycles
- compensation range:
  - x axis:  $\pm 1,5$  mm
  - y axis:  $\pm 1,5$  mm

### Characteristics

- Suitable, depending on size, for all MIXO connector inserts and frames, except series CT, CTS and CTSE.
- Designed to be used in the transportation, printing and power electronic industries (for example boxes for rack cabinets) and in all industrial applications that require, during assembly or maintenance, the connection of connectors without possibility of controlling the alignment.
- Enables the **self-centering coupling of two corresponding** connectors without the use of enclosures; they freely move on their base plate ( $\pm 1,5$  mm on both axes) ensuring the **alignment of the coupling**.

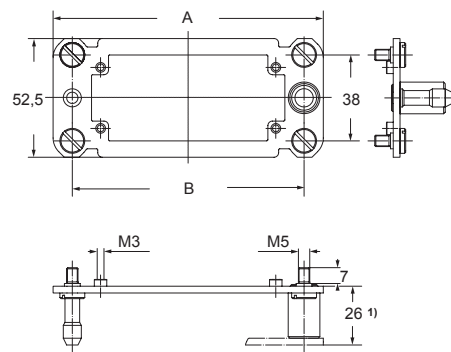

1) distance for electric and fibre optic contacts: max 27 mm  
 distance for pneumatic contacts: max 26,5 mm

### panel cut-out

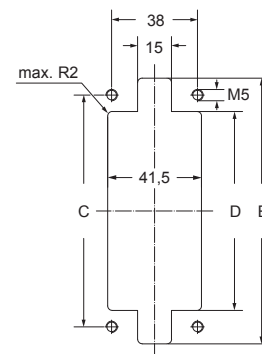

part No.	A	B	C	D	E
<b>CR 06 DF</b>	86	69	69	54,5	84
<b>CR 10 DF</b>	99	82	82	67,5	97
<b>CR 16 DF</b>	119,5	102,5	102,5	88	117,5
<b>CR 24 DF</b>	146	129	129	114,5	144

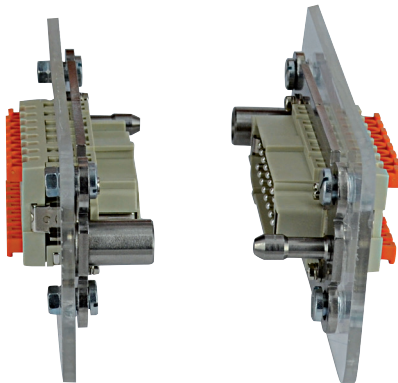

## CENTRAL LEVER series

### Easy access for robotics

Series specifically designed for industrial applications with limited installation space.

These enclosures can be installed, placed side-by-side and handled in a single operation.

Furthermore, the lever's shape reduces the effort required to uncouple the inner fittings.

#### SUM-UP OF MATERIALS USED FOR CH..YC, CA..YC and MA..YC, CA..YX and MF..YX series

- ☑ made of die cast aluminium alloy;
- ☑ with epoxy-polyester powder coating;
- ☑ gaskets in anti-aging, oil-resistant, grease-resistant and fuel-resistant vinyl nitrile elastomer;
- ☑ locking device with single stainless steel lever.





# CH - CA and MA CENTRAL LEVER

inserts		page:
CDD	42 poles + ⊕	78
CDS	18 poles + ⊕	-
CDSH	18 poles + ⊕	87
CNE	10 poles + ⊕	111
CSE	10 poles + ⊕	-
CSH	10 poles + ⊕	111
CSH S	10 poles + ⊕	123
CCE	10 poles + ⊕	131
CSS	10 poles + ⊕	149
CT, CTSE (16A *)	18 poles + ⊕	161
CQE	18 poles + ⊕	169
MIXO	3 modules	232 - 287

\*) can be used only in bulkhead mounting housings

## bulkhead mounting housings for central lever



## surface mounting housings, with two entries for central lever



description	part No.	part No.	entry Pg	part No.	entry M
bulkhead mounting with pegs	<b>CHI 06 YC</b>				
surface mounting, high construction, with pegs		<b>CAP 06 YC229</b>	29x2	<b>MAP 06 YC232</b>	32x2

### panel cut-out for bulkhead mounting housings

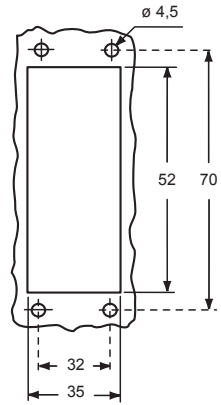

### CHI YC

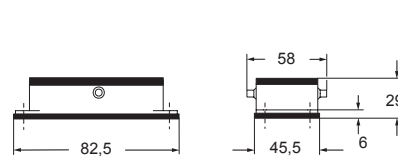

### CAP YC and MAP YC

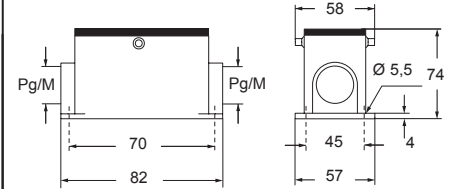

☑ Even when coding is not required, it is recommended to use CRM and CRF pins with CD and CDD inserts and CRM CX and CRF CX pins with MIXO inserts to reduce movements when fitting and removing the connectors and to avoid contact damages.

Within this scope, the DIN 43 652 standard requires a maximum angular longitudinal fluctuation of  $\pm 5^\circ$ .

**CRUS**® Type 4/4X/12



# CA and MA CENTRAL LEVER

inserts		page:
CDD	42 poles + ⊕	78
CDS	18 poles + ⊕	-
CDSH	18 poles + ⊕	87
CNE	10 poles + ⊕	111
CSE	10 poles + ⊕	-
CSH	10 poles + ⊕	111
CSH S	10 poles + ⊕	123
CCE	10 poles + ⊕	131
CSS	10 poles + ⊕	149
CQE	18 poles + ⊕	169
MIXO	3 modules	232 - 287

## hoods with central lever



## hoods with central lever



description	part No.		entry		part No.		entry	
			Pg	M			Pg	M
side entry, high construction	<b>CAO 06 YX21</b>	21	<b>MAO 06 YX25</b>	25				
side entry, high construction	<b>CAO 06 YX29</b>	29	<b>MAO 06 YX32</b>	32				
top entry, high construction					<b>CAV 06 YX21</b>	21	<b>MAV 06 YX25</b>	25
top entry, high construction					<b>CAV 06 YX29</b>	29	<b>MAV 06 YX32</b>	32

☑ Even when coding is not required, it is recommended to use CRM and CRF pins with CD and CDD inserts and CRM CX and CRF CX pins with MIXO inserts to reduce movements when fitting and removing the connectors and to avoid contact damages.

Within this scope, the DIN 43 652 standard requires a maximum angular longitudinal fluctuation of  $\pm 5^\circ$ .

### CAO..YX and MAO..YX

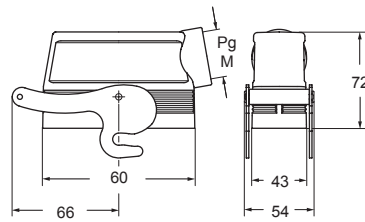

### CAV..YX and MAV..YX

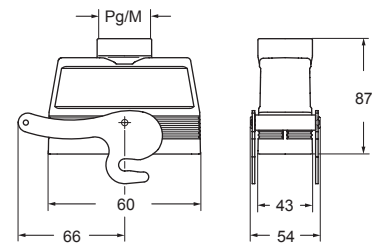

CENTRAL LEVER



Type 4/4X/12



# CA - MA and CF - MF CENTRAL LEVER

inserts		page:
CDD	42 poles + ⊕	78
CDS	18 poles + ⊕	-
CDSH	18 poles + ⊕	87
CNE	10 poles + ⊕	111
CSE	10 poles + ⊕	-
CSH	10 poles + ⊕	111
CSH S	10 poles + ⊕	123
CCE	10 poles + ⊕	131
CSS	10 poles + ⊕	149
CQE	18 poles + ⊕	169
MIXO	3 modules	232 - 287

## hoods for central lever



## hoods for central lever



description	part No.	entry Pg	part No.	entry M	part No.	entry Pg	part No.	entry M
with pegs, top entry, high construction	<b>CAV 06 GYC21</b>	21	<b>MAV 06 GYC25</b>	25				
with pegs, top entry, high construction	<b>CAV 06 GYC29</b>	29	<b>MAV 06 GYC32</b>	32				
with pegs, top entry, high construction			<b>MAV 06 GYC40</b>	40				
with pegs, top entry, high construction, without adapter *					<b>CFV 06 GYC21</b>	21	<b>MFV 06 GYC25</b>	25
with pegs, top entry, high construction, without adapter *					<b>CFV 06 GYC29</b>	29	<b>MFV 06 GYC32</b>	32
with pegs, top entry, high construction, without adapter *							<b>MFV 06 GYC40</b>	40

\* enclosure without adapter, threaded on the body, to be used only with a complete cable gland.

Even when coding is not required, it is recommended to use CRM and CRF pins with CD and CDD inserts and CRM CX and CRF CX pins with MIXO inserts to reduce movements when fitting and removing the connectors and to avoid contact damages.

Within this scope, the EN 175301-801 standard (former DIN 43 652) requires a maximum angular fluctuation of  $\pm 5^\circ$  on the long side,  $\pm 2^\circ$  on the short side.

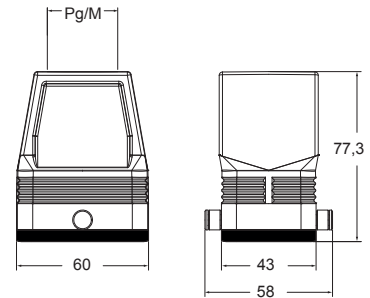
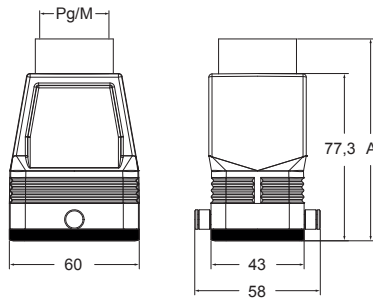

part No.	A
<b>CAV 06 GYC21</b>	92,3
<b>CAV 06 GYC29</b>	93,8
<b>MAV 06 GYC25</b>	92,3
<b>MAV 06 GYC32</b>	93,3
<b>MAV 06 GYC40</b>	96,3

cURus  
Type 12 / Type 4/4X  
pending



# CH - CA and MA CENTRAL LEVER

inserts		page:
CDD	42 poles + ⊕	78
CDS	18 poles + ⊕	-
CDSH	18 poles + ⊕	87
CNE	10 poles + ⊕	111
CSE	10 poles + ⊕	-
CSH	10 poles + ⊕	111
CSH S	10 poles + ⊕	123
CCE	10 poles + ⊕	131
CMSH	3+2 (aux) poles + ⊕	136
CMCE	3+2 (aux) poles + ⊕	137
CSS	10 poles + ⊕	149
CT, CTSE (16A) *)	10 poles + ⊕	161
CQE	18 poles + ⊕	169
CX	8/24 poles + ⊕	194
MIXO	3 modules	232 - 287

\*) can be used only in bulkhead mounting housings

## bulkhead mounting housings for central lever



## surface mounting housings, with two entries for central lever



description	part No.	part No.	entry Pg	part No.	entry M
bulkhead mounting with pegs	<b>CHI 10 YC</b>				
surface mounting, high construction, with pegs		<b>CAP 10 YC229</b>	29x2	<b>MAP 10 YC232</b>	32x2

panel cut-out for bulkhead mounting housings

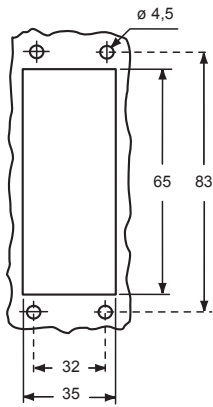

## CHI YC

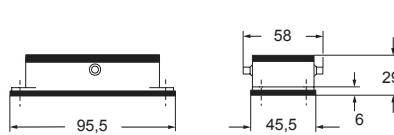

## CAP YC and MAP YC

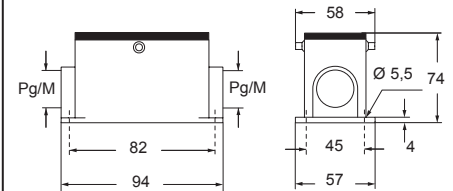

☑ Even when coding is not required, it is recommended to use CRM and CRF pins with CD and CDD inserts and CRM CX and CRF CX pins with MIXO inserts to reduce movements when fitting and removing the connectors and to avoid contact damages.

Within this scope, the DIN 43 652 standard requires a maximum angular longitudinal fluctuation of ±5°.

**CAU<sup>®</sup>US** Type 4/4X/12



CENTRAL LEVER

# CA and MA CENTRAL LEVER

inserts		page:
CDD	42 poles + ⊕	78
CDS	18 poles + ⊕	-
CDSH	18 poles + ⊕	87
CNE	10 poles + ⊕	111
CSE	10 poles + ⊕	-
CSH	10 poles + ⊕	111
CSH S	10 poles + ⊕	123
CCE	10 poles + ⊕	131
CMSH	3+2 (aux) poles + ⊕	136
CMCE	3+2 (aux) poles + ⊕	137
CSS	10 poles + ⊕	149
CQE	18 poles + ⊕	169
CX	8/24 poles + ⊕	194
MIXO	3 modules	232 - 287

## hoods with central lever



## hoods with central lever



description	part No.	entry Pg	part No.	entry M	part No.	entry Pg	part No.	entry M
side entry, high construction	<b>CAO 10 YX21</b>	21	<b>MAO 10 YX32</b>	32				
side entry, high construction	<b>CAO 10 YX29</b>	29	<b>MAO 10 YX40</b>	40				
top entry, high construction					<b>CAV 10 YX21</b>	21	<b>MAV 10 YX32</b>	32
top entry, high construction					<b>CAV 10 YX29</b>	29	<b>MAV 10 YX40</b>	40

☑ Even when coding is not required, it is recommended to use CRM and CRF pins with CD and CDD inserts and CRM CX and CRF CX pins with MIXO inserts to reduce movements when fitting and removing the connectors and to avoid contact damages.

Within this scope, the DIN 43 652 standard requires a maximum angular longitudinal fluctuation of  $\pm 5^\circ$ .

### CAO..YX and MAO..YX

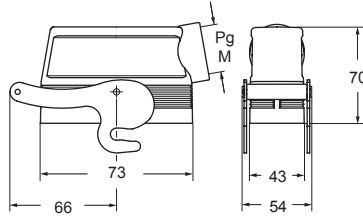

### CAV..YX and MAV..YX

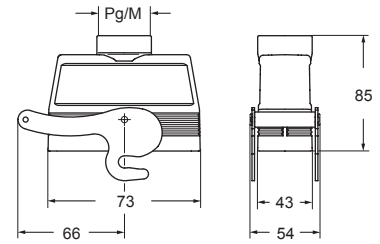

**CAU<sup>®</sup>US** Type 4/4X/12



# CA - MA and CF - MF CENTRAL LEVER

inserts		page:
CDD	42 poles + ⊕	78
CDS	18 poles + ⊕	-
CDSH	18 poles + ⊕	87
CNE	10 poles + ⊕	111
CSE	10 poles + ⊕	-
CSH	10 poles + ⊕	111
CSH S	10 poles + ⊕	123
CCE	10 poles + ⊕	131
CMSH	3+2 (aux) poles + ⊕	136
CMCE	3+2 (aux) poles + ⊕	137
CSS	10 poles + ⊕	149
CQE	18 poles + ⊕	169
CX	8/24 poles + ⊕	194
MIXO	3 modules	232 - 287

## hoods for central lever



## hoods for central lever



description	part No.	entry Pg	part No.	entry M	part No.	entry Pg	part No.	entry M
with pegs, top entry, high construction	<b>CAV 10 GYC21</b>	21	<b>MAV 10 GYC25</b>	25				
with pegs, top entry, high construction	<b>CAV 10 GYC29</b>	29	<b>MAV 10 GYC32</b>	32				
with pegs, top entry, high construction			<b>MAV 10 GYC40</b>	40				
with pegs, top entry, high construction, without adapter *					<b>CFV 10 GYC21</b>	21	<b>MFV 10 GYC25</b>	25
with pegs, top entry, high construction, without adapter *					<b>CFV 10 GYC29</b>	29	<b>MFV 10 GYC32</b>	32
with pegs, top entry, high construction, without adapter *							<b>MFV 10 GYC40</b>	40

\* enclosure without adapter, threaded on the body, to be used only with a complete cable gland.

☑ Even when coding is not required, it is recommended to use CRM and CRF pins with CD and CDD inserts and CRM CX and CRF CX pins with MIXO inserts to reduce movements when fitting and removing the connectors and to avoid contact damages.

Within this scope, the EN 175301-801 standard (former DIN 43 652) requires a maximum angular fluctuation of ±5° on the long side, ±2° on the short side.

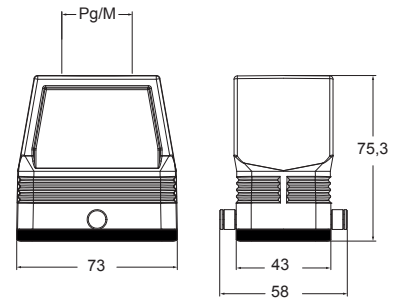
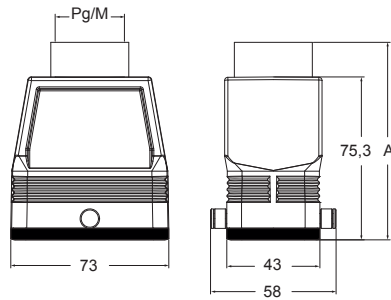

part No.	A
<b>CAV 10 GYC21</b>	90,3
<b>CAV 10 GYC29</b>	91,8
<b>MAV 10 GYC25</b>	90,3
<b>MAV 10 GYC32</b>	91,3
<b>MAV 10 GYC40</b>	94,3

cURus  
Type 12 / Type 4/4X  
pending





# CH - CA and MA CENTRAL LEVER

inserts		page:
CD	40 poles + ⊕	70
CDD	72 poles + ⊕	79
CDS	27 poles + ⊕	-
CDSH	27 poles + ⊕	88
CNE	16 poles + ⊕	112
CSE	16 poles + ⊕	-
CSH	16 poles + ⊕	112
CSH S	16 poles + ⊕	124
CCE	16 poles + ⊕	132
CMSH, CMCE	6+2 (aux) poles + ⊕	138 - 139
CSS	16 poles + ⊕	150
CT, CTS (10A) *)	40 poles + ⊕	156
CT, CTSE (16A) *)	16 poles + ⊕	162
CQE	32 poles + ⊕	170
CQEE	40 poles + ⊕	176
CP	6 poles + ⊕	178
CX	6/12, 6/36 and 12/2 poles + ⊕	197 - 199
CX	4/0 and 4/2 poles + ⊕	200 - 201
MIXO	4 modules	232 - 287

\*) can be used only in bulkhead mounting housings

## bulkhead mounting housings for central lever



## surface mounting housings, with two entries for central lever



description	part No.	part No.	entry Pg	part No.	entry M
-------------	----------	----------	----------	----------	---------

bulkhead mounting with pegs **CHI 16 YC**

surface mounting, high construction, with pegs

**CAP 16 YC229** 29x2

**MAP 16 YC232** 32x2

panel cut-out for bulkhead mounting housings

### CHI YC

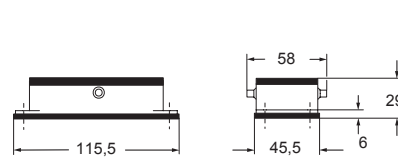

### CAP YC and MAP YC

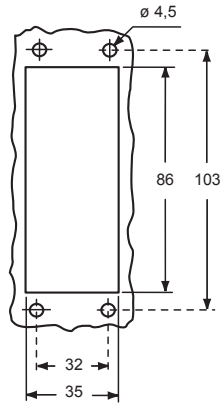
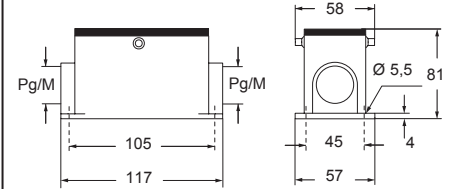

☑ Even when coding is not required, it is recommended to use CRM and CRF pins with CD and CDD inserts and CRM CX and CRF CX pins with MIXO inserts to reduce movements when fitting and removing the connectors and to avoid contact damages.

Within this scope, the DIN 43 652 standard requires a maximum angular longitudinal fluctuation of ±5°.

**CAU<sup>®</sup> US** Type 4/4X/12



# CA and MA CENTRAL LEVER

inserts		page:
CD	40 poles + ⊕	70
CDD	72 poles + ⊕	79
CDS	27 poles + ⊕	-
CDSH	27 poles + ⊕	88
CNE	16 poles + ⊕	112
CSE	16 poles + ⊕	-
CSH	16 poles + ⊕	112
CSH S	16 poles + ⊕	124
CCE	16 poles + ⊕	132
CMSH, CMCE	6+2 (aux) poles + ⊕	138 - 139
CSS	16 poles + ⊕	150
CQE	32 poles + ⊕	170
CQEE	40 poles + ⊕	176
CP	6 poles + ⊕	178
CX	6/12, 6/36 and 12/2 poles + ⊕	197 - 199
CX	4/0 and 4/2 poles + ⊕	200 - 201
MIXO	4 modules	232 - 287

## hoods with central lever



## hoods with central lever



description	part No.	entry Pg	part No.	entry M	part No.	entry Pg	part No.	entry M
side entry, high construction	CAO 16 YX21	21	MAO 16 YX32	32				
side entry, high construction	CAO 16 YX29	29	MAO 16 YX40	40				
top entry, high construction					CAV 16 YX21	21	MAV 16 YX32	32
top entry, high construction					CAV 16 YX29	29	MAV 16 YX40	40

Even when coding is not required, it is recommended to use CRM and CRF pins with CD and CDD inserts and CRM CX and CRF CX pins with MIXO inserts to reduce movements when fitting and removing the connectors and to avoid contact damages.

Within this scope, the DIN 43 652 standard requires a maximum angular longitudinal fluctuation of  $\pm 5^\circ$ .

### CAO..YX and MAO..YX

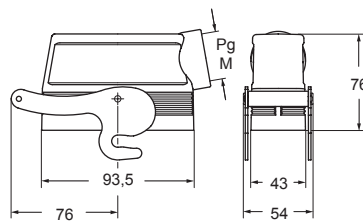

### CAV..YX and MAV..YX

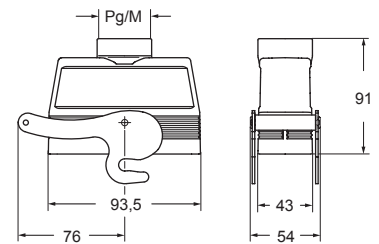

**CAUS**® Type 4/4X/12



# CA - MA and CF - MF CENTRAL LEVER

inserts		page:
CD	40 poles + ⊕	70
CDD	72 poles + ⊕	79
CDS	27 poles + ⊕	-
CDSH	27 poles + ⊕	88
CNE	16 poles + ⊕	112
CSE	16 poles + ⊕	-
CSH	16 poles + ⊕	112
CSH S	16 poles + ⊕	124
CCE	16 poles + ⊕	132
CMSH, CMCE	6+2 (aux) poles + ⊕	138 - 139
CSS	16 poles + ⊕	150
CQE	32 poles + ⊕	170
CQEE	40 poles + ⊕	176
CP	6 poles + ⊕	178
CX	6/12, 6/36 and 12/2 poles + ⊕	197 - 199
CX	4/0 and 4/2 poles + ⊕	200 - 201
MIXO	4 modules	232 - 287

## hoods for central lever



## hoods for central lever

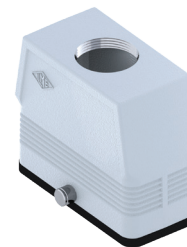

description	part No.	entry Pg	part No.	entry M	part No.	entry Pg	part No.	entry M
with pegs, top entry, high construction	<b>CAV 16 GYC21</b>	21	<b>MAV 16 GYC25</b>	25				
with pegs, top entry, high construction	<b>CAV 16 GYC29</b>	29	<b>MAV 16 GYC32</b>	32				
with pegs, top entry, high construction			<b>MAV 16 GYC40</b>	40				
with pegs, top entry, high construction, without adapter *					<b>CFV 16 GYC21</b>	21	<b>MFV 16 GYC25</b>	25
with pegs, top entry, high construction, without adapter *					<b>CFV 16 GYC29</b>	29	<b>MFV 16 GYC32</b>	32
with pegs, top entry, high construction, without adapter *							<b>MFV 16 GYC40</b>	40

\* enclosure without adapter, threaded on the body, to be used only with a complete cable gland.

Even when coding is not required, it is recommended to use CRM and CRF pins with CD and CDD inserts and CRM CX and CRF CX pins with MIXO inserts to reduce movements when fitting and removing the connectors and to avoid contact damages.

Within this scope, the EN 175301-801 standard (former DIN 43 652) requires a maximum angular fluctuation of ±5° on the long side, ±2° on the short side.

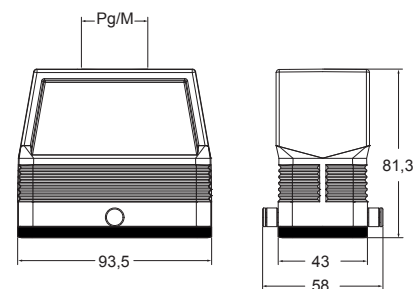
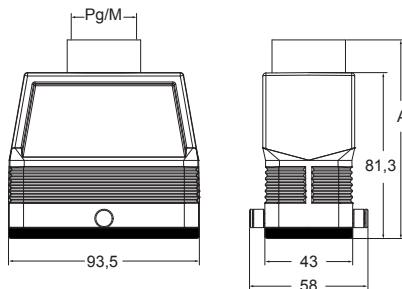

part No.	A
<b>CAV 16 GYC21</b>	96,3
<b>CAV 16 GYC29</b>	97,8
<b>MAV 16 GYC25</b>	96,3
<b>MAV 16 GYC32</b>	97,6
<b>MAV 16 GYC40</b>	100,3

cURus  
Type 12 / Type 4/4X  
pending



# CH - CA and MA CENTRAL LEVER

inserts		page:
CD	64 poles + ⊕	72
CDD	108 poles + ⊕	81
CDS	42 poles + ⊕	-
CDSH	42 poles + ⊕	89
CNE	24 poles + ⊕	113
CSE	24 poles + ⊕	-
CSH	24 poles + ⊕	113
CSH S	24 poles + ⊕	125
CCE	24 poles + ⊕	133
CMSH	10+2 (aux) poles + ⊕	140
CMCE	10+2 (aux) poles + ⊕	141
CSS	24 poles + ⊕	151
CT, CTS (10A) *)	64 poles + ⊕	157
CT, CTSE (16A) *)	24 poles + ⊕	163
CQE	46 poles + ⊕	171
CQEE	64 poles + ⊕	177
CX	4/8 and 6/6 poles + ⊕	204 and 206
MIXO	6 modules	232 - 287

\*) can be used only in bulkhead mounting housings

## bulkhead mounting housings for central lever



## surface mounting housings, with two entries for central lever



description	part No.	part No.	entry Pg	part No.	entry M
bulkhead mounting with pegs	CHI 24 YC				
surface mounting, high construction, with pegs		CAP 24 YC229	29x2	MAP 24 YC232	32x2

panel cut-out for bulkhead mounting housings

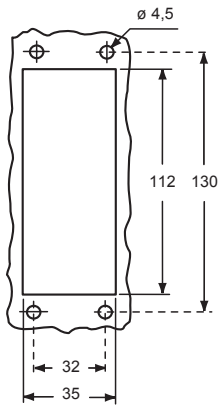

## CHI YC

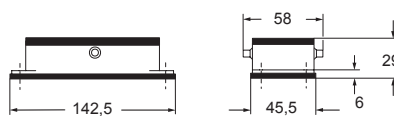

## CAP YC and MAP YC

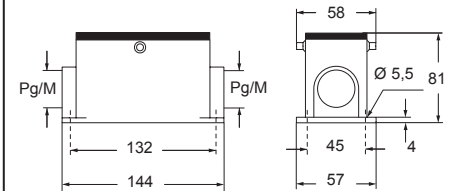

☑ Even when coding is not required, it is recommended to use CRM and CRF pins with CD and CDD inserts and CRM CX and CRF CX pins with MIXO inserts to reduce movements when fitting and removing the connectors and to avoid contact damages.

Within this scope, the DIN 43 652 standard requires a maximum angular longitudinal fluctuation of ±5°.

**CAIUS**® Type 4/4X/12



CENTRAL LEVER

# CA and MA - CI and MI CENTRAL LEVER

inserts		page:
CD	64 poles + ⊕	72
CDD	108 poles + ⊕	81
CDS	42 poles + ⊕	-
CDSH	42 poles + ⊕	89
CNE	24 poles + ⊕	113
CSE	24 poles + ⊕	-
CSH	24 poles + ⊕	113
CSH S	24 poles + ⊕	125
CCE	24 poles + ⊕	133
CMSH	10+2 (aux) poles + ⊕	140
CMCE	10+2 (aux) poles + ⊕	141
CSS	24 poles + ⊕	151
CQE	46 poles + ⊕	171
CQEE	64 poles + ⊕	177
CX	4/8 and 6/6 poles + ⊕	204 and 206
MIXO	6 modules	232 - 287

## hoods with central lever



## inclined hoods with central lever

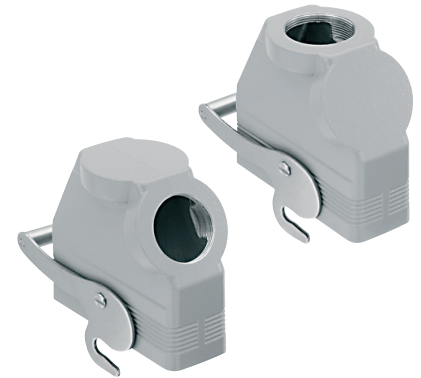

description	part No.		entry		part No.		entry	
		Pg	Pg	M		Pg	Pg	M
side entry, high construction	CAO 24 YX21	21	MAO 24 YX32	32				
side entry, high construction	CAO 24 YX29	29	MAO 24 YX40	40				
top entry, high construction	CAV 24 YX21	21	MAV 24 YX32	32				
top entry, high construction	CAV 24 YX29	29	MAV 24 YX40	40				
side entry, high construction					CIO 24 YX36	36	MIO 24 YX40	40
side entry, high construction							MIO 24 YX50	50
top entry, high construction							MIV 24 YX40	40
top entry, high construction					CIV 24 YX36	36	MIV 24 YX50	50

Even when coding is not required, it is recommended to use CRM and CRF pins with CD and CDD inserts and CRM CX and CRF CX pins with MIXO inserts to reduce movements when fitting and removing the connectors and to avoid contact damages.

Within this scope, the DIN 43 652 standard requires a maximum angular longitudinal fluctuation of ±5°.

### CAO..YX and MAO..YX

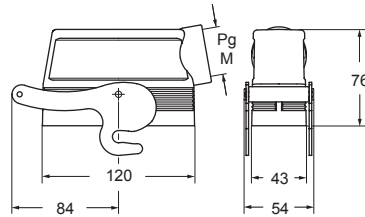

### CAV..YX and MAV..YX

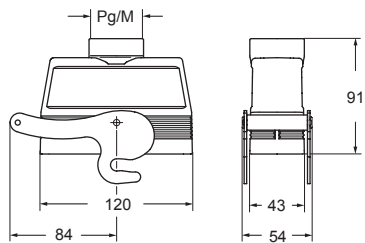

### CIO..YX and MIO..YX

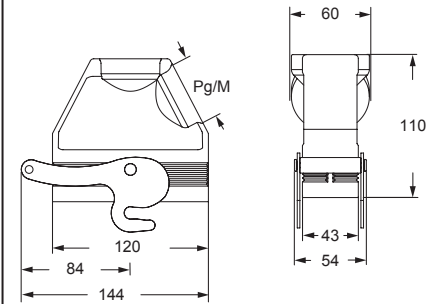

### CIV..YX and MIV..YX

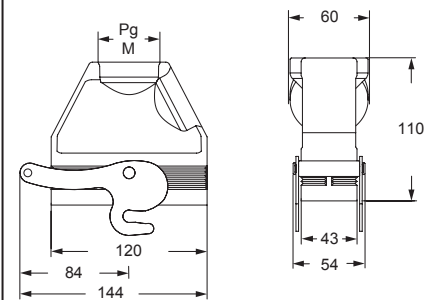

**CAUS** Type 4/4X/12



# CA - MA and CF - MF CENTRAL LEVER

inserts		page:
CD	64 poles + ⊕	72
CDD	108 poles + ⊕	81
CDS	42 poles + ⊕	-
CDSH	42 poles + ⊕	89
CNE	24 poles + ⊕	113
CSE	24 poles + ⊕	-
CSH	24 poles + ⊕	113
CSH S	24 poles + ⊕	125
CCE	24 poles + ⊕	133
CMSH	10+2 (aux) poles + ⊕	140
CMCE	10+2 (aux) poles + ⊕	141
CSS	24 poles + ⊕	151
CQE	46 poles + ⊕	171
CQEE	64 poles + ⊕	177
CX	4/8 and 6/6 poles + ⊕	204 and 206
MIXO	6 modules	232 - 287

## hoods for central lever



## hoods for central lever



description	part No.	entry Pg	part No.	entry M	part No.	entry Pg	part No.	entry M
with pegs, top entry, high construction	<b>CAV 24 GYC21</b>	21	<b>MAV 24 GYC25</b>	25				
with pegs, top entry, high construction	<b>CAV 24 GYC29</b>	29	<b>MAV 24 GYC32</b>	32				
with pegs, top entry, high construction			<b>MAV 24 GYC40</b>	40				
with pegs, top entry, high construction, without adapter *					<b>CFV 24 GYC21</b>	21	<b>MFV 24 GYC25</b>	25
with pegs, top entry, high construction, without adapter *					<b>CFV 24 GYC29</b>	29	<b>MFV 24 GYC32</b>	32
with pegs, top entry, high construction, without adapter *							<b>MFV 24 GYC40</b>	40

\* enclosure without adapter, threaded on the body, to be used only with a complete cable gland.

Even when coding is not required, it is recommended to use CRM and CRF pins with CD and CDD inserts and CRM CX and CRF CX pins with MIXO inserts to reduce movements when fitting and removing the connectors and to avoid contact damages.

Within this scope, the EN 175301-801 standard (former DIN 43 652) requires a maximum angular fluctuation of ±5° on the long side, ±2° on the short side.

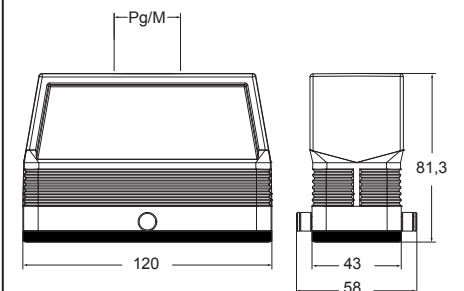
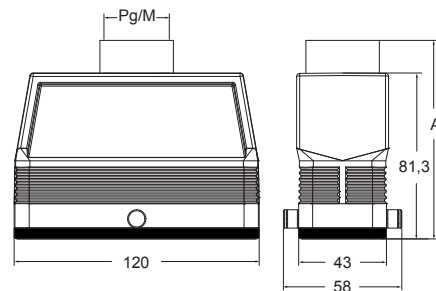

part No.	A
<b>CAV 24 GYC21</b>	96,3
<b>CAV 24 GYC29</b>	97,8
<b>MAV 24 GYC25</b>	96,3
<b>MAV 24 GYC32</b>	97,6
<b>MAV 24 GYC40</b>	100,3

cURus  
Type 12 / Type 4/4X  
pending





## Locking device for single stainless steel central locking lever

- **locking device**, made in **stainless steel**, with **proprietary design**, that can be easily placed on the side of the central lever of a "104.27" hood in order to lock the opening movement of the locking lever, thus avoiding any unwanted and potentially hazardous accidental opening of the connector coupling under working condition;
- **possibility to apply, optionally, a padlock** (CR BLC622, separately available, 6 mm shackle diameter, 22 mm arc clearance) with **anti-tamper function**, to secure the locking against any unauthorized attempt to open the locking lever and disconnect the connector coupling;
- **two versions available:**  
with eyelet cord end, **CR YLK24**  
for the fastening to a housing of a central lever coupling when not in use;



with "loop" cord end, **CR YLK24 SL**  
for the fastening to a hood when not in use (around the incoming cable).



# CR YLK24 – CR YLK24 SL CENTRAL LEVER

enclosures  
central lever size "104.27"

page:  
612 - 614

Locking device  
for enclosure with central lever  
size "104.27"

Padlock, 22 mm arc clearance,  
optional

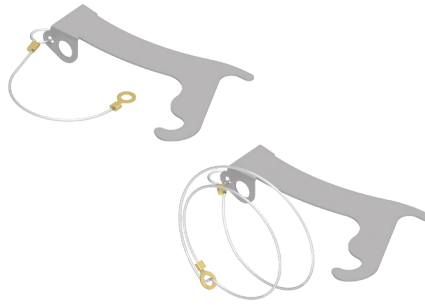

description	part No. (with eyelet)	part No. (with loop)	part. No.
locking device with eyelet for fixing on housings	<b>CR YLK24</b>		
locking device with loop for fixing on hoods		<b>CR YLK24 SL</b>	
padlock (YALE 1100040), supplied with 2 keys			<b>CR BLC622</b>

**CR YLK24 and CR YLK24 SL**

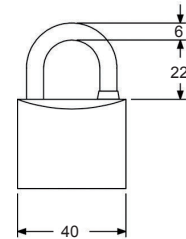
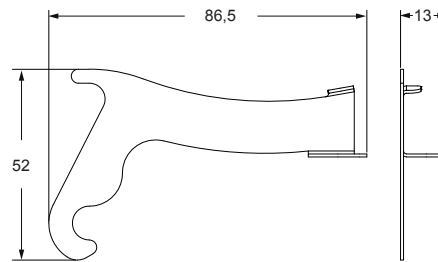

**For fixing on housings**

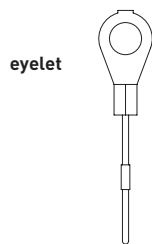

**For fixing on hoods**

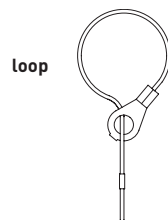

cURus pending

## LS-TYPE series

### On stage

The **LS-TYPE** enclosures are the ideal solution for the entertainment industry (lighting system power supply and related mixer and dimmer panels), including theatre stages, film sets, radio and TV studios, discos, trade fair booths, concert halls and night public events, both indoors and outdoors, etc.

All parts are in elegant RAL 9005 black to make them suitable for situations and locations where they should not be visible in the dark.

#### Functional characteristics

For use with inserts in self-extinguishing thermoplastic material (PPS polyphenylene sulphide).

UL certified for USA and Canada for NEMA 4, NEMA 4X and NEMA 12 degrees of protection (enclosure type ratings) printed on the packaging.

IP65/IP69 degree of protection.



#### SUM-UP

##### OF MATERIALS USED

FOR CK..R, CZ..R, CH..R, CA..R  
and MK..R, MZ..R, MH..R, MA..R series

- made of die cast aluminium alloy;
- chromate conversion coating, RoHS 2 conform treatment of die cast;
- coated with special thermosetting powder coating with high resistant to high temperatures;
- gaskets in anti-aging FKM fluoroelastomer;
- locking device with levers, springs and pins in stainless steel;
- single-block locking levers in stainless steel (for CZ..R, CH..R 48 and MZ..R, MH..R 48 versions);
- lever handles in aluminium with special die-cast coating (for CH..R 10, 16, 24 and MH..R 10, 16, 24 versions);
- supplementary insulation inside enclosures.

# CH..N - MA..N and MH..N - MF..N LS-TYPE version

inserts		page:
CDD	42 poles + ⊕	78
CDS	18 poles + ⊕	-
CDSH	18 poles + ⊕	87
CNE	10 poles + ⊕	111
CSE	10 poles + ⊕	-
CSH	10 poles + ⊕	111
CSH S	10 poles + ⊕	123
CCE	10 poles + ⊕	131
CSS	10 poles + ⊕	149
CT, CTSE (16A) *)	10 poles + ⊕	161
CQE	18 poles + ⊕	169
MIXO	3 modules	232 - 287

\*) only in the CHIN 06 LCH and CHIN 06 L enclosure

## housings with 2 pegs and 1 lever



## hoods with 2 pegs



description	part No.	entry M	part No.	entry M
bulkhead mounting housing, with 2 pegs	<b>CHIN 06 LCH</b>			
bulkhead mounting housing, with lever	<b>CHIN 06 L</b>			
surface mounting housing, high construction, with lever	<b>MAPN 06 L32</b>	32		
with pegs, side entry			<b>MHON 06 L25</b>	25
with pegs, top entry			<b>MHVN 06 L25</b>	25
with pegs, side entry, high construction, without adapter *			<b>MFON 06 L25</b>	25
with pegs, top entry, high construction, without adapter *			<b>MFVN 06 L25</b>	25

\* enclosure without adapter, threaded on the enclosure body, to be used only with a complete cable gland.

- kiln powder coating with RAL 9005 black epoxy polyester powder
- RAL 9005 black self-extinguishing thermoplastic locking lever

**Spare part lever CR 06 LN**  
for "44.27" enclosures with levers

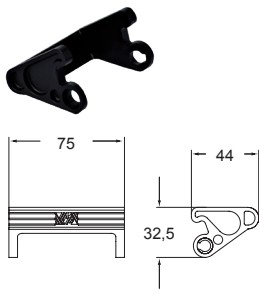

### CHIN LCH

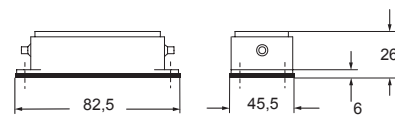

### CHIN L

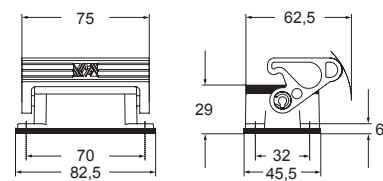

### MAPN L32

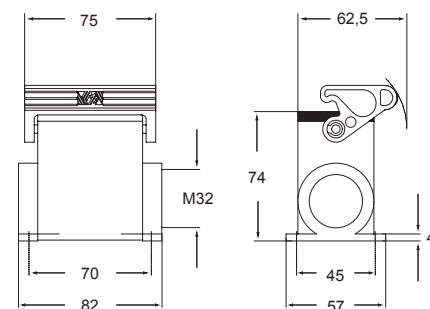

panel cut-out for bulkhead mounting housings  
CHIN LCH and CHIN L

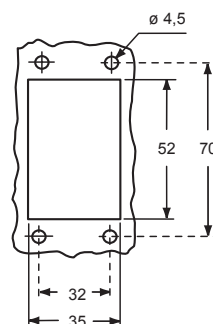

### MHON L25

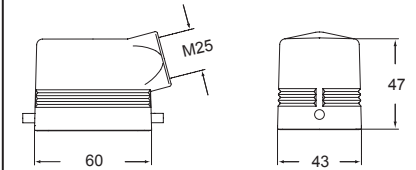

### MHVN L25

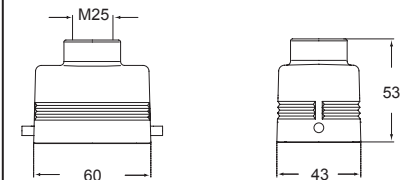

### MFON L25

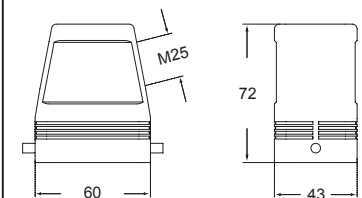

### MFVN L25

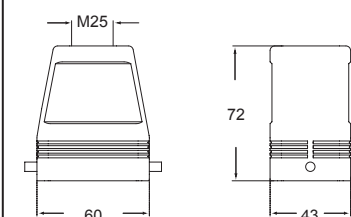

**CSU**® Type 4/4X/12



# CH..N and MH..N - MF..N LS-TYPE version

inserts		page:
CDD	42 poles + ⊕	78
CDS	18 poles + ⊕	-
CDSH	18 poles + ⊕	87
CNE	10 poles + ⊕	111
CSE	10 poles + ⊕	-
CSH	10 poles + ⊕	111
CSH S	10 poles + ⊕	123
CCE	10 poles + ⊕	131
CSS	10 poles + ⊕	149
CQE	18 poles + ⊕	169
MIXO	3 modules	232 - 287

## hoods with single lever



## covers



description	part No.	entry M	part No. (with eyelet)	part No. (with loop)
-------------	----------	---------	------------------------	----------------------

with lever and gasket, top entry  
with lever and gasket, top entry, high construction, without adapter \*

**MHVN 06 LG25** 25  
**MFVN 06 LG25** 25

covers with pegs  
covers with lever

**CHCN 06 L**

**CHCN 06 LG**

\* enclosure without adapter, threaded on the enclosure body, to be used only with a complete cable gland.

### MHVN LG25

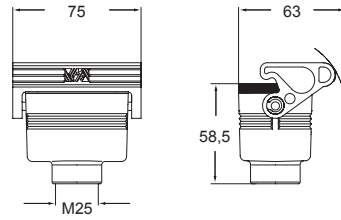

### CHCN L

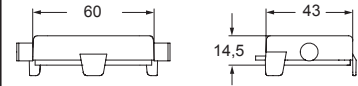

- kiln powder coating with RAL 9005 black epoxy polyester powder  
- RAL 9005 black self-extinguishing thermoplastic locking lever

**Spare part lever CR 06 LN**  
for "44.27" enclosures with levers

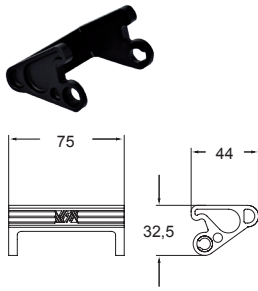

### MFVN LG25

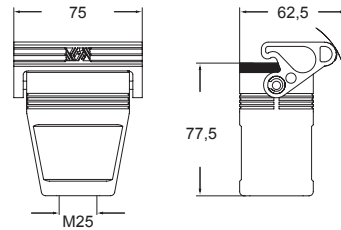

### CHCN LG

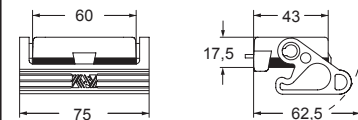

For fixing on housings

eyelet

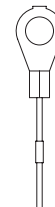

For fixing on hoods

loop

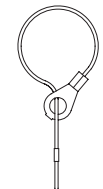

**CRUS** Type 4/4X/12



# CH..N - MA..N and MH..N - MF..N LS-TYPE version

inserts		page:
CDD	42 poles + ⊕	78
CDS	18 poles + ⊕	-
CDSH	18 poles + ⊕	87
CNE	10 poles + ⊕	111
CSE	10 poles + ⊕	-
CSH	10 poles + ⊕	111
CSH S	10 poles + ⊕	123
CCE	10 poles + ⊕	131
CMSH	3+2 (aux) poles + ⊕	136
CMCE	3+2 (aux) poles + ⊕	137
CSS	10 poles + ⊕	149
CT, CTSE (16A) *)	10 poles + ⊕	161
CQE	18 poles + ⊕	169
CX	8/24 poles + ⊕	194
MIXO	3 modules	232 - 287

\*) only in the CHIN 10 CH and CHIN 10 enclosure

## housings with 4 pegs and 2 levers



## hoods with 4 pegs



description	part No.	entry M	part No.	entry M
bulkhead mounting housing, with 4 pegs	<b>CHIN 10 CH</b>			
bulkhead mounting housing, with 2 levers	<b>CHIN 10</b>			
surface mounting housing, high construction, with 2 levers	<b>MAPN 10.32</b>	32		
with pegs, side entry			<b>MHON 10.25</b>	25
with pegs, top entry			<b>MHVN 10.25</b>	25
with pegs, side entry, high construction, without adapter *			<b>MFON 10.32</b>	32
with pegs, top entry, high construction, without adapter *			<b>MFVN 10.32</b>	32

\* enclosure without adapter, threaded on the enclosure body, to be used only with a complete cable gland.

- kiln powder coating with RAL 9005 black epoxy polyester powder
- RAL 9005 black self-extinguishing thermoplastic locking lever

**Spare part lever CR LN**  
for "57.27" enclosures with levers

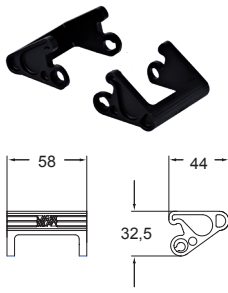

### CHIN CH

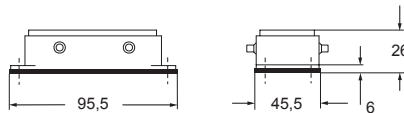

### CHIN

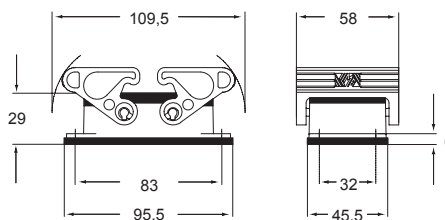

### MAPN

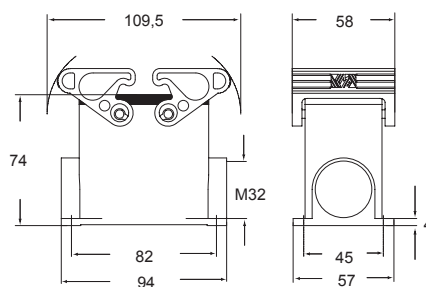

panel cut-out for bulkhead mounting housings  
CHIN CH and CHIN

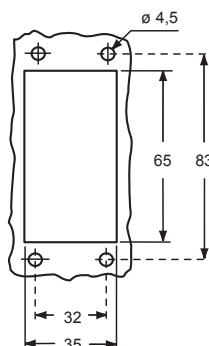

### MHON

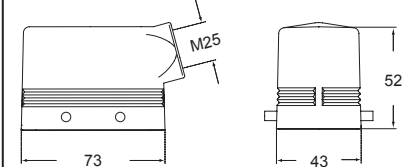

### MHVN

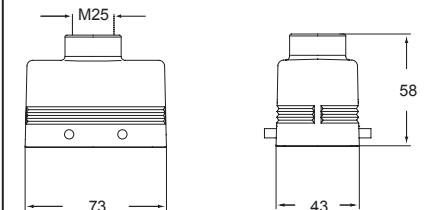

### MFON

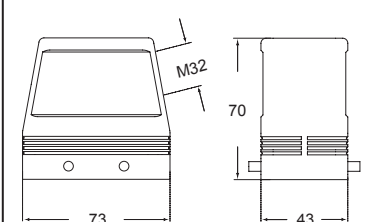

### MFVN

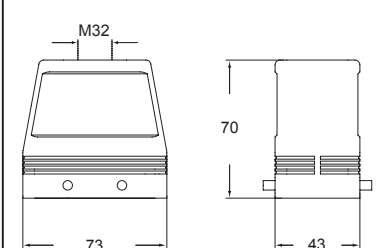

**CAIUS** Type 4/4X/12





# CH..N and MH..N - MF..N LS-TYPE version

inserts		page:
CDD	42 poles + ⊕	78
CDS	18 poles + ⊕	-
CDSH	18 poles + ⊕	87
CNE	10 poles + ⊕	111
CSE	10 poles + ⊕	-
CSH	10 poles + ⊕	111
CSH S	10 poles + ⊕	123
CCE	10 poles + ⊕	131
CMSH	3+2 (aux) poles + ⊕	136
CMCE	3+2 (aux) poles + ⊕	137
CSS	10 poles + ⊕	149
CQE	18 poles + ⊕	169
CX	8/24 poles + ⊕	194
MIXO	3 modules	232 - 287

## hoods with 2 levers



## covers



description	part No.	entry M	part No. (with eyelet)	part No. (with loop)
-------------	----------	---------	------------------------	----------------------

with levers and gasket, top entry	<b>MHVN 10 G25</b>	25		
with levers and gasket, top entry, high construction, without adapter *	<b>MFVN 10 G220</b>	20 x 2		
with levers and gasket, top entry, high construction, without adapter *	<b>MFVN 10 G32</b>	32		

covers with pegs  
covers with 2 levers

**CHCN 10**

**CHCN 10 G**

\* enclosure without adapter, threaded on the enclosure body, to be used only with a complete cable gland.

- kiln powder coating with RAL 9005 black epoxy polyester powder
- RAL 9005 black self-extinguishing thermoplastic locking lever

**Spare part lever CR LN**  
for "57.27" enclosures with levers

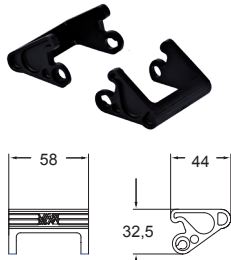

### MHVN G25

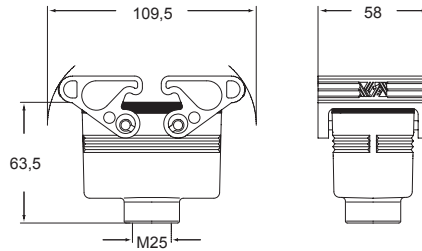

### MFVN 10 G220

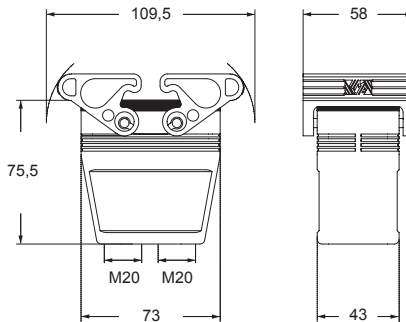

### MFVN G32

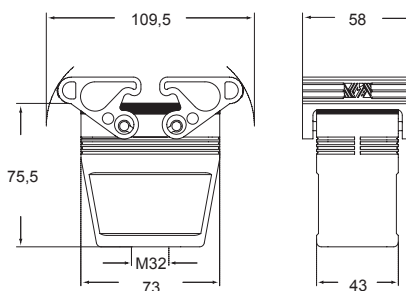

### CHCN

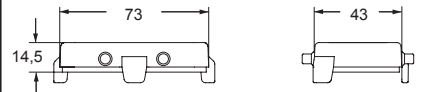

### CHCN G

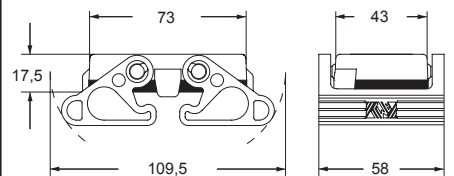

For fixing on housings

eyelet

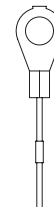

For fixing on hoods

loop

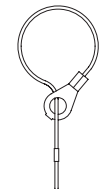

**CE** **UL** **US** Type 4/4X/12



# CH..N - MA..N and MH..N - MF..N LS-TYPE version

inserts		page:
CD	40 poles + ⊕	70
CDD	72 poles + ⊕	79
CDS	27 poles + ⊕	-
CDSH	27 poles + ⊕	88
CNE	16 poles + ⊕	112
CSE	16 poles + ⊕	-
CSH	16 poles + ⊕	112
CSH S	16 poles + ⊕	124
CCE	16 poles + ⊕	132
CMSH, CMCE	6+2 (aux) poles + ⊕	138 - 139
CSS	16 poles + ⊕	150
CT, CTS (10A) *)	40 poles + ⊕	156
CT, CTSE (16A) *)	16 poles + ⊕	162
CQE	32 poles + ⊕	170
CQEE	40 poles + ⊕	176
CP	6 poles + ⊕	178
CX	6/12, 6/36 and 12/2 poles + ⊕	197 - 199
CX	4/0 and 4/2 poles + ⊕	200 - 201
MIXO	4 modules	232 - 287

\*) only in the CHIN 16 CH and CHIN 16 enclosure

## housings with 4 pegs and 2 levers



## hoods with 4 pegs



description	part No.	entry M	part No.	entry M
bulkhead mounting housing, with 4 pegs	<b>CHIN 16 CH</b>			
bulkhead mounting housing, with 2 levers	<b>CHIN 16</b>			
surface mounting housing, high construction, with 2 levers	<b>MAPN 16.32</b>	32		
with pegs, side entry			<b>MHON 16.32</b>	32
with pegs, top entry			<b>MHVN 16.32</b>	32
with pegs, side entry, high construction, without adapter *			<b>MFON 16.32</b>	32
with pegs, top entry, high construction, without adapter *			<b>MFVN 16.32</b>	32

\* enclosure without adapter, threaded on the enclosure body, to be used only with a complete cable gland.

- kiln powder coating with RAL 9005 black epoxy polyester powder
- RAL 9005 black self-extinguishing thermoplastic locking lever

**Spare part lever CR LN**  
for "77.27" enclosures with levers

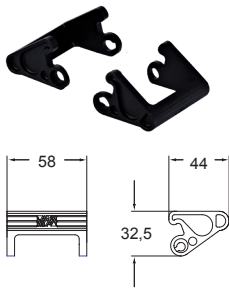

### CHIN CH

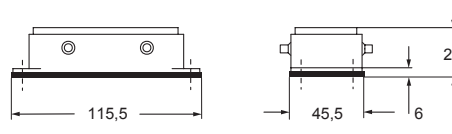

### CHIN

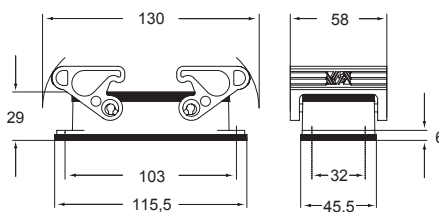

### MAPN

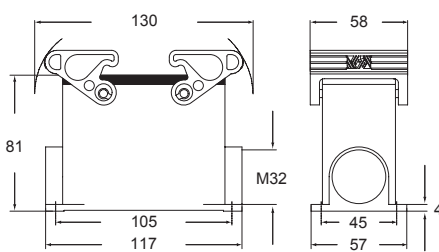

panel cut-out for bulkhead mounting housings  
CHIN CH and CHIN

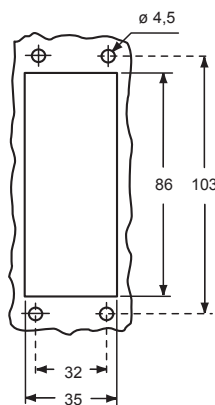

### MHON

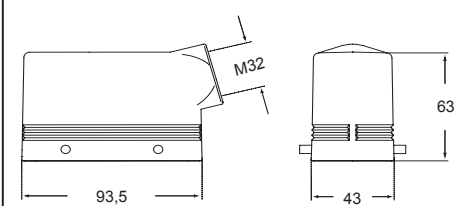

### MHVN

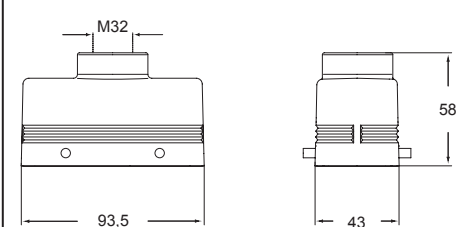

### MFON

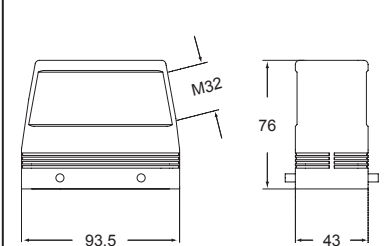

### MFVN

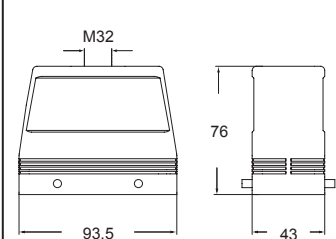

**CAIUS** Type 4/4X/12



# CH..N and MH..N - MF..N LS-TYPE version

inserts		page:
CD	40 poles + ⊕	70
CDD	72 poles + ⊕	79
CDS	27 poles + ⊕	-
CDSH	27 poles + ⊕	88
CNE	16 poles + ⊕	112
CSE	16 poles + ⊕	-
CSH	16 poles + ⊕	112
CSH S	16 poles + ⊕	124
CCE	16 poles + ⊕	132
CMSH, CMCE	6+2 (aux) poles + ⊕	138 - 139
CSS	16 poles + ⊕	150
CQE	32 poles + ⊕	170
CQEE	40 poles + ⊕	176
CP	6 poles + ⊕	178
CX	6/12, 6/36 and 12/2 poles + ⊕	197 - 199
CX	4/0 and 4/2 poles + ⊕	200 - 201
MIXO	4 modules	232 - 287

## hoods with 2 levers



## covers



description	part No.	entry M	part No. (with eyelet)	part No. (with loop)
-------------	----------	---------	------------------------	----------------------

with levers and gasket, top entry	<b>MHVN 16 G32</b>	32		
with levers and gasket, top entry, high construction, without adapter *	<b>MFVN 16 G225</b>	25 x 2		
with levers and gasket, top entry, high construction, without adapter *	<b>MFVN 16 G32</b>	32		

covers with pegs  
covers with 2 levers

**CHCN 16**

**CHCN 16 G**

\* enclosure without adapter, threaded on the enclosure body, to be used only with a complete cable gland.

- kiln powder coating with RAL 9005 black epoxy polyester powder
- RAL 9005 black self-extinguishing thermoplastic locking lever

**Spare part lever CR LN**  
for "77.27" enclosures with levers

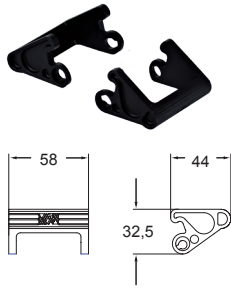

### MHVN G32

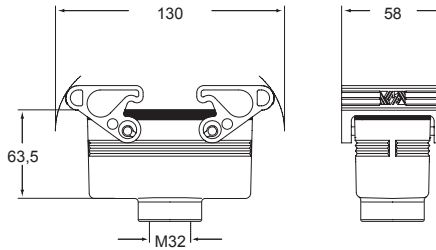

### MFVN 16 G225

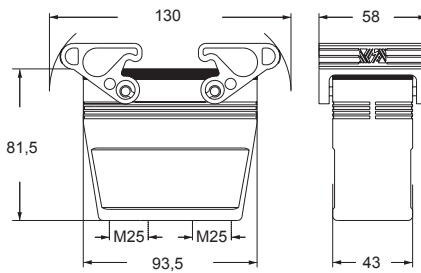

### MFVN G32

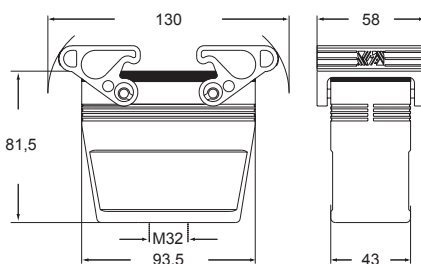

### CHCN

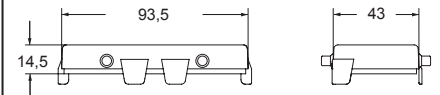

### CHCN G

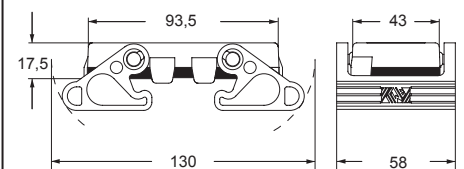

For fixing on housings

eyelet

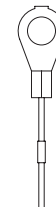

For fixing on hoods

loop

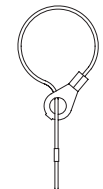

**CE** **UL** **US** Type 4/4X/12



# CH..N - MA..N and MH..N - MF..N LS-TYPE version

inserts

CD	64 poles + ⊕	72
CDD	108 poles + ⊕	81
CDS	42 poles + ⊕	-
CDSH	42 poles + ⊕	89
CNE	24 poles + ⊕	113
CSE	24 poles + ⊕	-
CSH	24 poles + ⊕	113
CSH S	24 poles + ⊕	125
CCE	24 poles + ⊕	133
CMSH	10+2 (aux) poles + ⊕	140
CMCE	10+2 (aux) poles + ⊕	141
CSS	24 poles + ⊕	151
CT, CTS (10A) *)	64 poles + ⊕	157
CT, CTSE (16A) *)	24 poles + ⊕	163
CQE	46 poles + ⊕	171
CQEE	64 poles + ⊕	177
CX	4/8 and 6/6 poles + ⊕	204 and 206
MIXO	6 modules	232 - 287

\*) only in the CHIN 24 CH and CHIN 24 enclosure

page: housings with 4 pegs and 2 levers



hoods with 4 pegs



description	part No.	entry M	part No.	entry M
bulkhead mounting housing, with 4 pegs	<b>CHIN 24 CH</b>			
bulkhead mounting housing, with 2 levers	<b>CHIN 24</b>			
surface mounting housing, high construction, with 2 levers	<b>MAPN 24.32</b>	32		
with pegs, side entry			<b>MHON 24.32</b>	32
with pegs, top entry			<b>MHVN 24.32</b>	32
with pegs, side entry, high construction, without adapter *			<b>MFON 24.32</b>	32
with pegs, top entry, high construction, without adapter *			<b>MFVN 24.32</b>	32

\* enclosure without adapter, threaded on the enclosure body, to be used only with a complete cable gland.

- kiln powder coating with RAL 9005 black epoxy polyester powder
- RAL 9005 black self-extinguishing thermoplastic locking lever

**Spare part lever CR LN**  
for "104.27" enclosures with levers

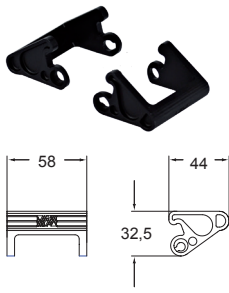

**CHIN CH**

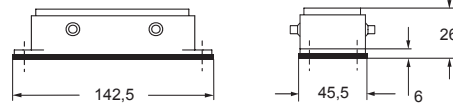

**CHIN**

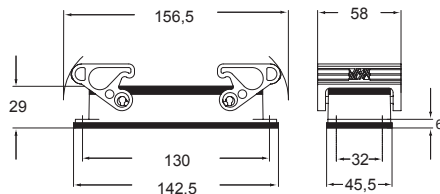

**MAPN**

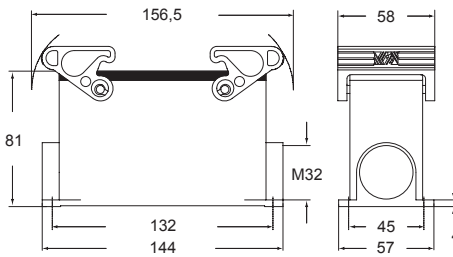

panel cut-out for bulkhead mounting housings CHIN CH and CHIN

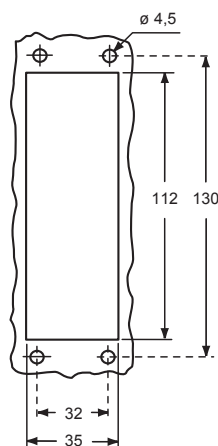

**MHON**

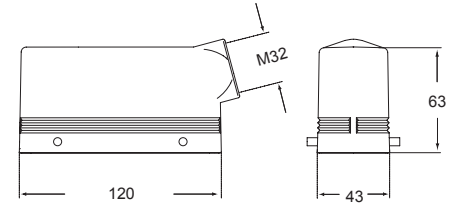

**MHVN**

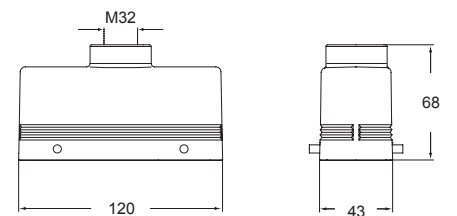

**MFON**

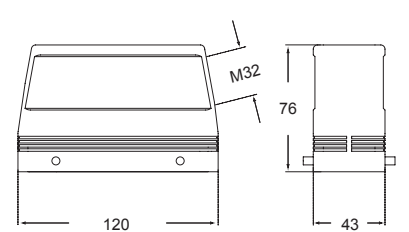

**MFVN**

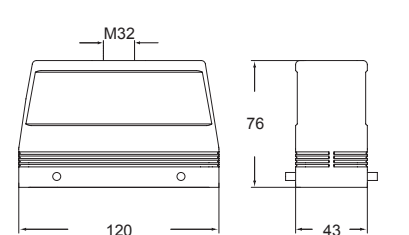

**CAIUS** Type 4/4X/12



LS-TYPE

# CH..N and MH..N - MF..N LS-TYPE version

inserts		page:
CD	64 poles + ⊕	72
CDD	108 poles + ⊕	81
CDS	42 poles + ⊕	-
CDSH	42 poles + ⊕	89
CNE	24 poles + ⊕	113
CSE	24 poles + ⊕	-
CSH	24 poles + ⊕	113
CSH S	24 poles + ⊕	125
CCE	24 poles + ⊕	133
CMSH	10+2 (aux) poles + ⊕	140
CMCE	10+2 (aux) poles + ⊕	141
CSS	24 poles + ⊕	151
CQE	46 poles + ⊕	171
CQEE	64 poles + ⊕	177
CX	4/8 and 6/6 poles + ⊕	204 and 206
MIXO	6 modules	232 - 287

## hoods with 2 levers



## covers



description	part No.	entry M	part No. (with eyelet)	part No. (with loop)
-------------	----------	---------	------------------------	----------------------

with levers and gasket, top entry	<b>MHVN 24 G32</b>	32		
with levers and gasket, top entry, high construction, without adapter *	<b>MFVN 24 G232</b>	32 x 2		
with levers and gasket, top entry, high construction, without adapter *	<b>MFVN 24 G32</b>	32		

covers with pegs	<b>CHCN 24</b>			
covers with 2 levers				<b>CHCN 24 G</b>

\* enclosure without adapter, threaded on the enclosure body, to be used only with a complete cable gland.

- kiln powder coating with RAL 9005 black epoxy polyester powder
- RAL 9005 black self-extinguishing thermoplastic locking lever

**Spare part lever CR LN**  
for "104.27" enclosures with levers

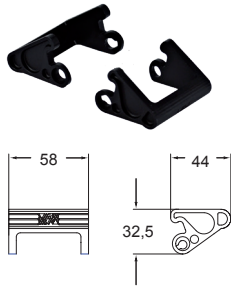

### MHVN G32

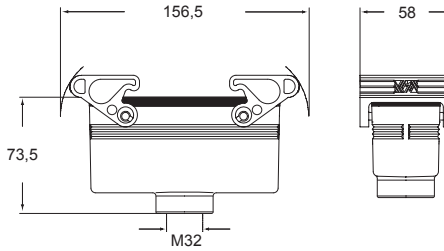

### MFVN 24 G232

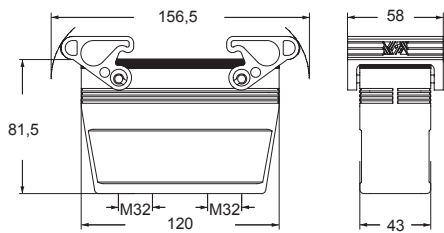

### MFVN G32

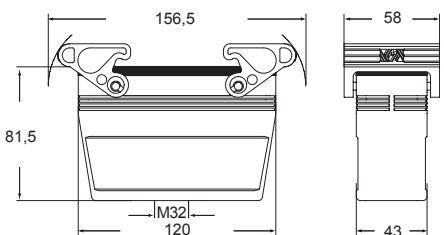

### CHCN

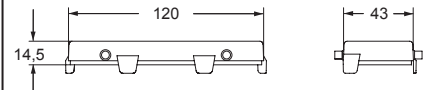

### CHCN G

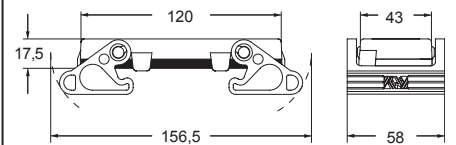

For fixing on housings

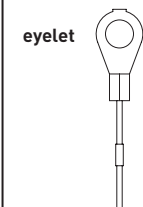

For fixing on hoods

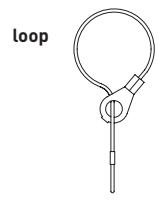

**CEC®** Type 4/4X/12



# CGK/MGK (“21.21”) series and CG/MG (“44.27”, “57.27”, “77.27”, “104.27”) series

CGK/MGK and CG/MG series of free and fixed enclosures (hoods and housings) for heavy-duty rectangular connectors combine water tightness to **IP68** according EN IEC 60529, the “versatile” complete IP degree of protection of these enclosures being actually IP66/IP68/IP69, high mechanical sturdiness and enhanced immunity to electromagnetic disturbances and shielding of the surrounding against emission (EMC features).

The enclosures ensure the highest degree of protection from external interferences; more specifically, they protect people from accessing the hazardous components housed inside the enclosures (protection against shock by direct contact) and they protect the internal connector inserts from the ingress of foreign matters (dust tightness) and from the harmful effects of ingress of fluids (water tightness).

The water tightness between the bulkhead-mounting housings and the panel is ensured by an O-ring seal held in position in a slot within the bulkhead-mounting housing base.

A second O-ring seal fitted around the mating edges of the enclosure ensures the water tightness between the free and the fixed enclosure when the connector is mated and locked.

To ensure the water tightness when the enclosure is fitted onto a cabinet panel, the optional mounting frame with four M6 threaded blind holes may need to be installed inside the panel.

The fastening screws must be fitted inside the enclosure and, through the fastening holes to be drilled on the panel, must be tightened onto the M6 mounting frame internal thread instead of the usual fastening nuts. The bulkhead-mounting fixed enclosure fastening holes have been drilled within the perimeter of the O-ring seal, in order to avoid having to use further seals.

Although these enclosures are larger than the standard enclosures, to leave more space for the cables, and the walls are thicker to achieve more mechanical robustness, the fixing points have remained the same as those of the standard enclosures. The series is offered with two types of locking systems: **bayonet** and **screw**.

The two closing points are located in asymmetrical positions on the short side of the housing so as to ensure an optimal water tightness while keeping the lowest footprint to allow more compactness in case of multiple enclosures placed one close to the other on the short side. The locking means of both versions are made of high quality stainless steel and are firmly fastened inside the free enclosure. These locking means can be fitted and removed by using either a 1,5 mm flat blade screwdriver or a 10 mm hexagonal key. The fixed and free enclosures of series CG/MG are made of foundry grade aluminium alloy, particularly resistant to seawater corrosion.

Series CGK/MGK enclosures are made of zinc alloy. The finish of CG/MG series is made from epoxy powder, which gives the enclosures high scratch and shock resistant properties as well as good chemical resistance.

The finish of CGK/MGK series (size “21.21”) is made by black chrome plating RoHS 2 conform.

The metal covers are made with the same quality materials as the enclosures, and are fitted with a short cord to make it always retrievable.

### Scope of application

External interconnections in vehicles, in harsh environments and in humid areas and with sensitive interconnections requiring shielding from electromagnetic interference.

They are particularly suitable for the applications in the railway industry and any application requiring high resistance to pressure, impact and corrosion, with IP66/**IP68**/IP69 protection rating.

They also ensure a good shielding for electromagnetic compatibility.

The IP68 degree of protection marked or assigned to the enclosure is ensured if the enclosures are correctly installed and the cable entry devices have equal or higher IP rating.

### Degree of protection compliant with EN IEC 60529

When mated and locked, the CGK/MGK (“21.21”) and the CG/MG enclosures protect the connector inserts fitted inside from outside interference, such as mechanical shocks, foreign bodies, humidity, dust, water or other fluids such as cleaning or cooling agents, oils, etc.

The IP68 degree of protection ensured by the enclosures is fully described in the EN IEC 60529 standard, which classifies the enclosures according to their protection against the entry of foreign bodies and water.

**IP68** = Total protection against dust, and against the access to hazardous parts with access probe of Ø 1,0 mm (1st characteristic numeral), and protection against the effects of continuous submersion in water (duration ≥ 30 min upon agreement and water depth ≥ 1 m upon agreement) (2nd characteristic numeral).

These enclosures have also successfully passed the tests required for the **IPX6** degree of protection (tightness to powerful water jets) and for the **IPX9** degree of protection (high pressure and temperature water jets) according to EN IEC 60529. Their full “versatile” degree of protection is therefore **IP66/IP68/IP69**.

The following table shows only the IP 68 level of protection. Please see page 46 for the complete table of the different levels of protection specified by the IP standard.

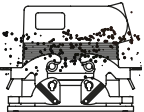
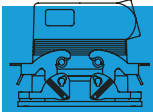
FIRST Index figure	Degree of protection <b>SOLIDS</b>		SECOND Index figure	Degree of protection <b>WATER</b>	
<b>6</b>		Protected against access to hazardous parts with a wire dust-tight (total protection against dust)	<b>8</b>		Protected against the effects of continuous immersion in water at depth and/or duration upon agreement.



# CG/MG (“44.27”, “57.27”, “77.27”, “104.27”) series

- 1 Threaded cable entry hole, available in different Pg diameters (types with prefix starting with “C”) or metric thread (types with prefix starting with “M”) compliant with EN 60423 standard, for cable entry devices compliant with EN IEC 62444 standard (former EN 50262), for vertical or horizontal layout.
- 2 Sturdy, corrosion proof foundry grade aluminium alloy enclosures, with RoHS 2 conform chromate treatment. The following types are available: wall mounted, flush mounted fixed and free enclosures with free protective cover.
- 3 Oven cured thermosetting paint with epoxy powder, colour black RAL 9005, which gives the enclosures a high mechanical strength and makes them resistant to external agents (only CG/MG).
- 4 The inserts are made of UL certified self-extinguishing fibreglass reinforced thermoplastics, and feature an operating temperature range between -40 °C and +125 °C.
- 5 Insert profile polarised with asymmetrical guides to avoid incorrect matings. The inserts have a mechanical life equal to or higher than 500 mating cycles.
- 6 Inserts are manufactured in compliance with European standard EN IEC 61984 (former DIN VDE 0627), certified and identified with UL and CSA marks, as well as EAC (Eurasian Customs Union) and CQC (China) marks, according to type and series.
- 7 Special NBR elastomer, anti-ageing, oil and fuel resistant seals which, together with the cable entry devices (not supplied) ensure mated connectors IP66/IP68/IP69 degree of protection. The seals are internally positioned to give a better protection from sunlight and outside elements.
- 8 Locking is available in two solutions: **screw-type** with hexagonal head stainless steel screws or **bayonet-type**. The slotted hexagonal head screws can be fitted and removed by using either a 1,5 mm thick blade screwdriver or a 10 mm hexagonal key, and can be easily accessed even when fitted on enclosures with horizontally exited cables. Tightening torque 2,5 Nm.

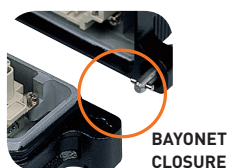

- 9 Captive insert fastening screws, with anti-slackening spring washer.
- 10 Contact position identified with numbers or codes on both sides of each insert and printed with a laser system or from a die.

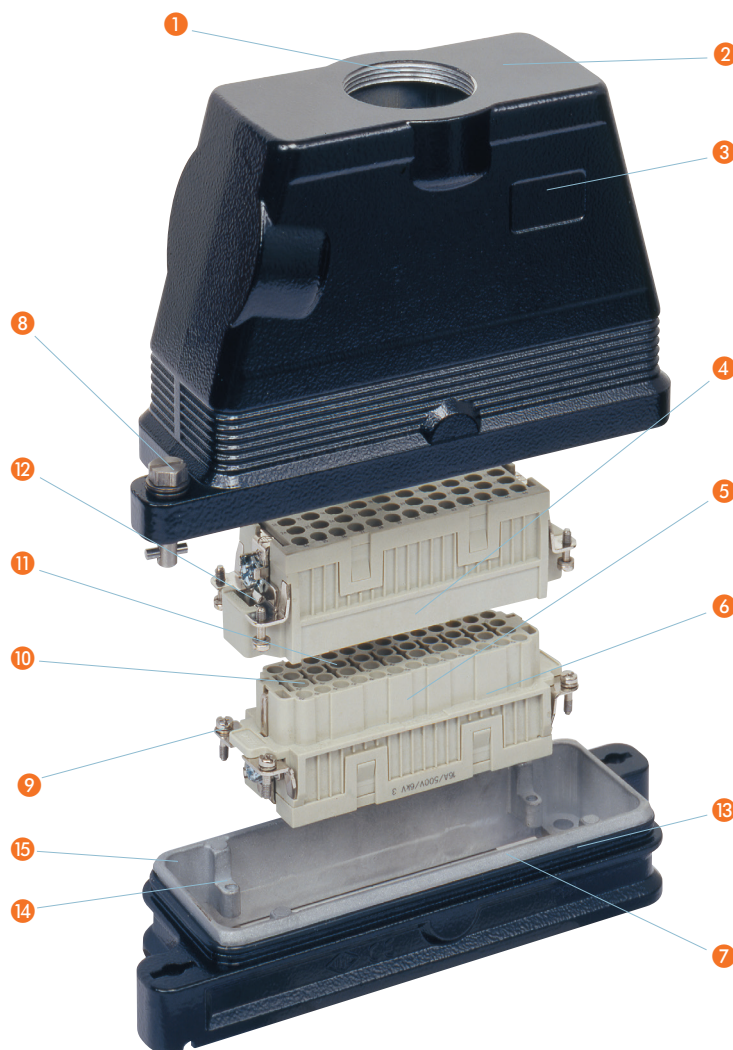

- 11 Silver or gold plated brass contacts connected to the wires by means of captive screws supplied already slackened, with spring terminal (SQUICH®), by means of crimping (crimp contacts available separately), or with a built-in 45° terminal block (still with screw or spring terminal).
- 12 Pre-leading (FMLB) protective earth terminal with a wide contact surface.
- 13 Fixed, bulkhead-mount enclosure with fastening screws inside the gasket.
- 14 Wider enclosures to give more space for the cabling.
- 15 They ensure a good screening for electromagnetic compatibility, resistance to vibrations in compliance with EN 61373 railway standard and to pressurised water (IPX9).

IP 68

# CGK and MGK high protection IP68 version

inserts		page:
CK	3 and 4 poles + ⊕	58
CKS	3 and 4 poles + ⊕	-
CKSH	3 and 4 poles + ⊕	63
CD *	8 poles	67
CQ4	2 poles + ⊕	182
CQ4 H	2 poles + ⊕	183
CQ4	3 poles + ⊕	184
CQ	5 poles + ⊕	186
CQ	7 poles + ⊕	187
CQ	12 poles + ⊕	189
CQ	21 poles + ⊕	190
CJ KF (can be used only in I enclosures)		305
CJK 8MT		308
CJK 8IMT		308
CLK 04 SC		321
CX 1/2 BD		325

\* To ensure IP68 degree of protection with CD 08 insert, purchase the kit CKR 65 D.

☑ In this case do not use the screw supplied with the enclosure.

## bulkhead mounting housings



## angled bulkhead mounting housings



description	part No.	part No.	entry Pg	part No.	entry M
bulkhead mounting housing	<b>CGK I</b>	<b>CGK IA</b>			
without cable entry (on request)		<b>CGK IAP13</b>	13,5	<b>MGK IAP20</b>	20
with cable entry, bottom closed					

## ANGLED BULKHEAD MOUNTING HOUSINGS

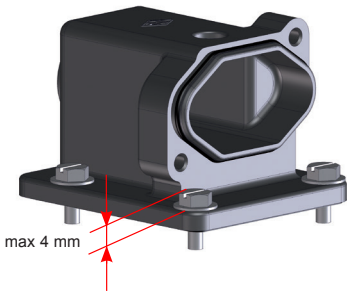

- Eliminate the gasket and the fixing screw; provided with the insert
- To fix the insert, use the screw with gasket provided with the enclosure (except CD 08 see note above).

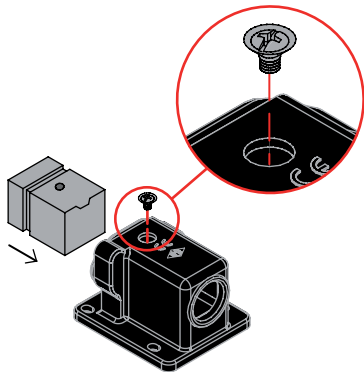

dust protection cover  
CGKCP FX  
(page 697)



**CAIUS**® Type 4/4X/12



according to IEC/EN 60529

## CGK I

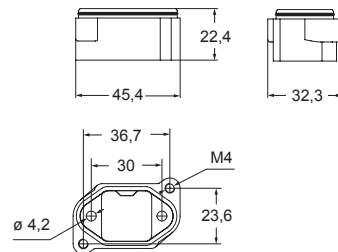

panel cut-out for CGK I enclosures

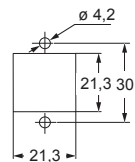

## CGK IA

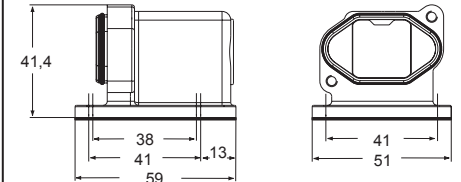

panel cut-out for CGK IA enclosures

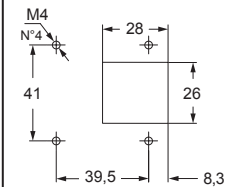

## CGK IAP and MGK IAP

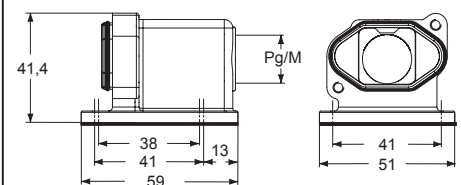

panel cut-out for CGK/MGK IAP enclosures

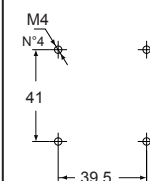

IP68

# CGK and MGK high protection IP68 version (screw locking)

inserts		page:
CK	3 and 4 poles + ⊕	58
CKS	3 and 4 poles + ⊕	-
CKSH	3 and 4 poles + ⊕	63
CD *	8 poles	67
CQ4	2 poles + ⊕	182
CQ4 H	2 poles + ⊕	183
CQ4	3 poles + ⊕	184
CQ	5 poles + ⊕	186
CQ	7 poles + ⊕	187
CQ	12 poles + ⊕	189
CQ	21 poles + ⊕	190
CJ KM (can be used only in hoods)		305
CJK 8MT		308
CJK 8IMT		308
CLK 04 SC		321
CX 1/2 BD		325

\* To ensure IP68 degree of protection with CD 08 insert, purchase the kit CKR 65 D.

In this case do not use the screw supplied with the enclosure.

## hoods



## hoods



description	part No.	entry Pg	part No.	entry M	part No.	entry M
top entry	<b>CGK V13</b>	13,5	<b>MGK V20</b>	20		
top entry					<b>MGK V25</b>	25

- Eliminate the gasket and the fixing screw; provided with the insert
- To fix the insert, use the screw with gasket provided with the enclosure (except CD 08 see note above).

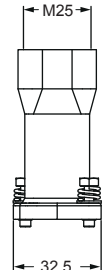
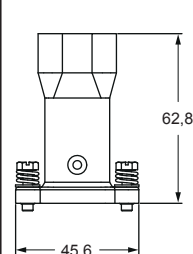
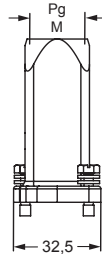
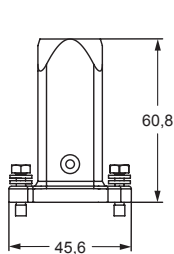

**CRUS**® Type 4/4X/12



according to IEC/EN 60529

cURus Type 12 / Type 4/4X only with CKR 65 (D) pending



according to IEC/EN 60529

# CGK high protection IP68 version (bayonet locking)

inserts		page:
CK	3 and 4 poles + ⊕	58
CKS	3 and 4 poles + ⊕	-
CKSH	3 and 4 poles + ⊕	63
CD *	8 poles	67
CQ4	2 poles + ⊕	182
CQ4 H	2 poles + ⊕	183
CQ4	3 poles + ⊕	184
CQ	5 poles + ⊕	186
CQ	7 poles + ⊕	187
CQ	12 poles + ⊕	189
CQ	21 poles + ⊕	190
CJ KF (can be used only in I enclosures)		305
CJK 8MT		308
CJK 8IMT		308
CLK 04 SC		321
CX 1/2 BD		325

\* To ensure IP68 degree of protection with CD 08 insert, purchase the kit CKR 65 D.

In this case do not use the screw supplied with the enclosure.

## bulkhead mounting housings



description	part No.
-------------	----------

bulkhead mounting housing

**CGK I B**

- Eliminate the gasket and the fixing screw; provided with the insert
- To fix the insert, use the screw with gasket provided with the enclosure (except CD 08 see note above).

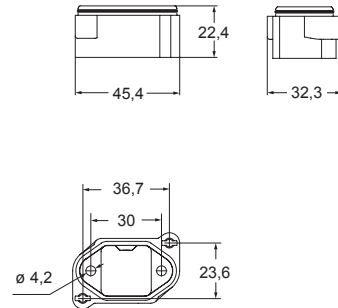

panel cut-out for CGK I B enclosures

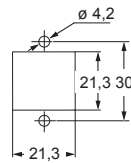

dust protection cover  
CGKCP FX  
(page 697)



**CAIUS**® Type  
4/4X/12



according to IEC/EN 60529

# CGK and MGK high protection IP68 version (bayonet locking)

inserts		page:
CK	3 and 4 poles + ⊕	58
CKS	3 and 4 poles + ⊕	-
CKSH	3 and 4 poles + ⊕	63
CD *	8 poles	67
CQ4	2 poles + ⊕	182
CQ4 H	2 poles + ⊕	183
CQ4	3 poles + ⊕	184
CQ	5 poles + ⊕	186
CQ	7 poles + ⊕	187
CQ	12 poles + ⊕	189
CQ	21 poles + ⊕	190
CJ KM (can be used only in hoods)		305
CJK 8MT		308
CJK 8IMT		308
CLK 04 SC		321
CX 1/2 BD		325

\* To ensure IP68 degree of protection with CD 08 insert, purchase the kit CKR 65 D.

In this case do not use the screw supplied with the enclosure.

## hoods



## hoods



description	part No.	entry Pg	part No.	entry M	part No.	entry M
top entry	<b>CGK V13 B</b>	13,5	<b>MGK V20 B</b>	20		
top entry					<b>MGK V25 B</b>	25

- Eliminate the gasket and the fixing screw; provided with the insert
- To fix the insert, use the screw with gasket provided with the enclosure (except CD 08 see note above).

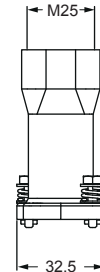
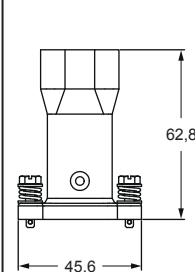
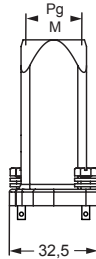
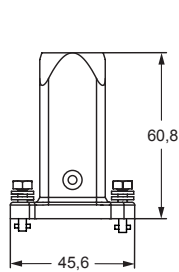

dust protection cover  
CGKCP MB  
(page 697)



**CE** **UL** **US** Type 4/4X/12



according to IEC/EN 60529

cURus Type 12 / Type 4/4X only with CKR 65 (D) pending



according to IEC/EN 60529

# CG and MG high protection IP68 version (screw locking)

inserts		page:
CDD	24 poles + ⊕	76
CDS	9 poles + ⊕	-
CDSH	9 poles + ⊕	86
CDSH NC	6 poles + ⊕	95
CNE	6 poles + ⊕	110
CSE	6 poles + ⊕	-
CSH	6 poles + ⊕	110
CSH S	6 poles + ⊕	122
CCE	6 poles + ⊕	130
CSS	6 poles + ⊕	148
CQE	10 poles + ⊕	168
MIXO	2 modules	232 - 287

## bulkhead mounting housings



## surface mounting housings



description	part No.	part No.	entry Pg	part No.	entry M
with gasket, size "44.27"	<b>CGI 06</b>				
size "44.27"		<b>CGP 06.29</b>	29	<b>MGP 06.32</b>	32

### CGI

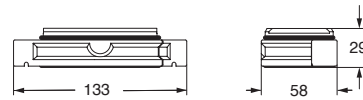

panel cut-out for bulkhead mounting housings

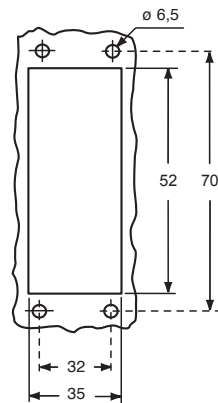

### CGP and MGP

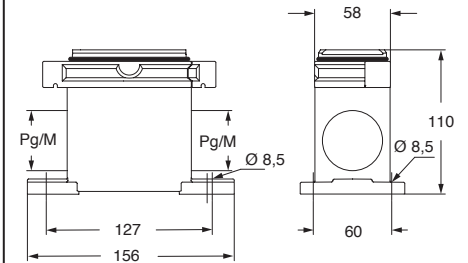

Dust protection cover CGCP FX (from page 697)



**CAUS** Type 4/4X/12



according to IEC/EN 60529

IP68



# CG and MG high protection IP68 version (screw locking)

inserts		page:
CDD	24 poles + ⊕	76
CDS	9 poles + ⊕	-
CDSH	9 poles + ⊕	86
CDSH NC	6 poles + ⊕	95
CNE	6 poles + ⊕	110
CSE	6 poles + ⊕	-
CSH	6 poles + ⊕	110
CSH S	6 poles + ⊕	122
CCE	6 poles + ⊕	130
CSS	6 poles + ⊕	148
CQE	10 poles + ⊕	168
MIXO	2 modules	232 - 287

## hoods



## covers



description	part No.	entry Pg	part No	entry M	part No.
with side entry					
size "44.27"	<b>CGO 06.16</b>	16	<b>MGO 06.25</b>	25	
size "44.27"	<b>CGO 06.21</b>	21	<b>MGO 06.32</b>	32	
size "44.27"	<b>CGO 06.29</b>	29			
with top entry					
size "44.27"	<b>CGV 06.16</b>	16	<b>MGV 06.25</b>	25	
size "44.27"	<b>CGV 06.21</b>	21	<b>MGV 06.32</b>	32	
size "44.27"	<b>CGV 06.29</b>	29	<b>MGV 06.40</b>	40	
size "44.27"					<b>CGC 06</b>

### CGO/MGO and CGV/MGV

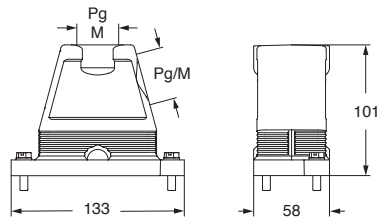

### CGC

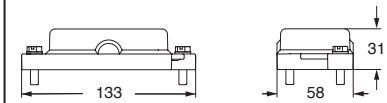

Dust protection cover CGCP MB (from page 697)



**CE** <sup>®</sup> **US** Type 4/4X/12



according to IEC/EN 60529

# CG high protection IP68 version (bayonet locking)

inserts		page:
CDD	24 poles + ⊕	76
CDS	9 poles + ⊕	-
CDSH	9 poles + ⊕	86
CDSH NC	6 poles + ⊕	95
CNE	6 poles + ⊕	110
CSE	6 poles + ⊕	-
CSH	6 poles + ⊕	110
CSH S	6 poles + ⊕	122
CCE	6 poles + ⊕	130
CSS	6 poles + ⊕	148
CQE	10 poles + ⊕	168
MIXO	2 modules	232 - 287

## bulkhead mounting housings



description	part No.
-------------	----------

with gasket, size "44.27" **CGI 06 B**

### CGI B

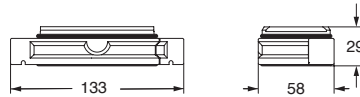

### panel cut-out for bulkhead mounting housings

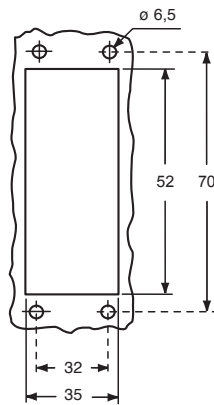

Dust protection cover CGCP FX (from page 697)



**CAUS**® Type 4/4X/12



according to IEC/EN 60529

IP68

# CG and MG high protection IP68 version (bayonet locking)

inserts		page:
CDD	24 poles + ⊕	76
CDS	9 poles + ⊕	-
CDSH	9 poles + ⊕	86
CDSH NC	6 poles + ⊕	95
CNE	6 poles + ⊕	110
CSE	6 poles + ⊕	-
CSH	6 poles + ⊕	110
CSH S	6 poles + ⊕	122
CCE	6 poles + ⊕	130
CSS	6 poles + ⊕	148
CQE	10 poles + ⊕	168
MIXO	2 modules	232 - 287

## hoods



## covers



description	part No.	entry Pg	part No	entry M	part No.
with side entry					
size "44.27"	<b>CGO 06.16 B</b>	16	<b>MGO 06.25 B</b>	25	
size "44.27"	<b>CGO 06.21 B</b>	21	<b>MGO 06.32 B</b>	32	
size "44.27"	<b>CGO 06.29 B</b>	29			
with top entry					
size "44.27"	<b>CGV 06.16 B</b>	16	<b>MGV 06.25 B</b>	25	
size "44.27"	<b>CGV 06.21 B</b>	21	<b>MGV 06.32 B</b>	32	
size "44.27"	<b>CGV 06.29 B</b>	29	<b>MGV 06.40 B</b>	40	
size "44.27"					<b>CGC 06 B</b>

### CGO/MGO B and CGV/MGV B

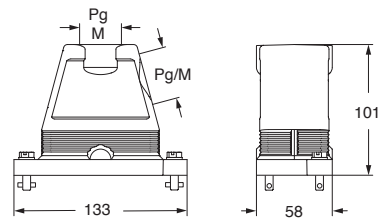

### CGC B

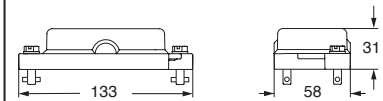

Dust protection cover CGCP MB (from page 697)



**CE** <sup>®</sup> **US** Type 4/4X/12



according to IEC/EN 60529

# CG and MG high protection IP68 version (screw locking)

inserts		page:
CDD	42 poles + ⊕	78
CDS	18 poles + ⊕	-
CDSH	18 poles + ⊕	87
CNE	10 poles + ⊕	111
CSE	10 poles + ⊕	-
CSH	10 poles + ⊕	111
CSH S	10 poles + ⊕	123
CCE	10 poles + ⊕	131
CMSH	3+2 (aux) poles + ⊕	136
CMCE	3+2 (aux) poles + ⊕	137
CSS	10 poles + ⊕	149
CQE	18 poles + ⊕	169
CX	8/24 poles + ⊕	194
MIXO	3 modules	232 - 287

## bulkhead mounting housings



## surface mounting housings

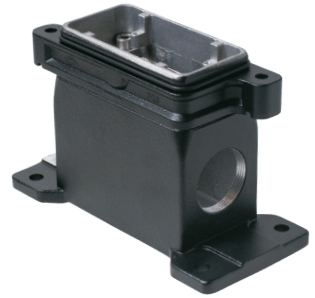

description	part No.	part No.	entry Pg	part No.	entry M
with gasket, size "57.27"	<b>CGI 10</b>				
size "57.27"		<b>CGP 10.29</b>	29	<b>MGP 10.32</b>	32

### CGI

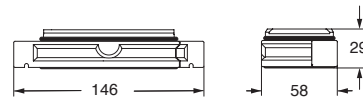

panel cut-out for bulkhead mounting housings

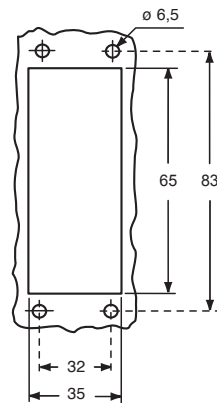

### CGP and MGP

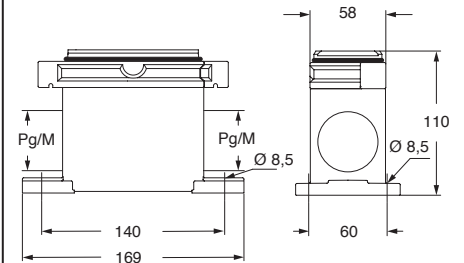

Dust protection cover CGCP FX (from page 697)



**CAVUS**® Type 4/4X/12



according to IEC/EN 60529

IP68

# CG and MG high protection IP68 version (screw locking)

inserts		page:
CDD	42 poles + ⊕	78
CDS	18 poles + ⊕	-
CDSH	18 poles + ⊕	87
CNE	10 poles + ⊕	111
CSE	10 poles + ⊕	-
CSH	10 poles + ⊕	111
CSH S	10 poles + ⊕	123
CCE	10 poles + ⊕	131
CMSH	3+2 (aux) poles + ⊕	136
CMCE	3+2 (aux) poles + ⊕	137
CSS	10 poles + ⊕	149
CQE	18 poles + ⊕	169
CX	8/24 poles + ⊕	194
MIXO	3 modules	232 - 287

## hoods



## covers



description	part No.	entry Pg	part No.	entry M	part No.
with side entry					
size "57.27"	<b>CGO 10.16</b>	16	<b>MGO 10.25</b>	25	
size "57.27"	<b>CGO 10.21</b>	21	<b>MGO 10.32</b>	32	
size "57.27"	<b>CGO 10.29</b>	29			
with top entry					
size "57.27"	<b>CGV 10.16</b>	16	<b>MGV 10.25</b>	25	
size "57.27"	<b>CGV 10.21</b>	21	<b>MGV 10.32</b>	32	
size "57.27"	<b>CGV 10.29</b>	29	<b>MGV 10.40</b>	40	

## CGC 10

### CGO/MGO and CGV/MGV

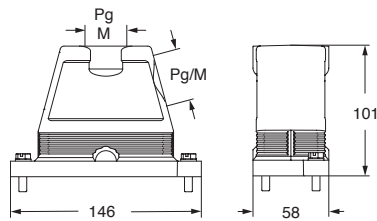

### CGC

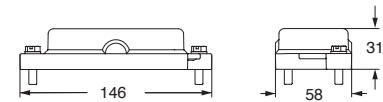

Dust protection cover CGCP MB (from page 697)



**CE** **RU** <sup>®</sup> **US** Type 4/4X/12



according to IEC/EN 60529

# CG high protection IP68 version (bayonet locking)

inserts		page:
CDD	42 poles + ⊕	78
CDS	18 poles + ⊕	-
CDSH	18 poles + ⊕	87
CNE	10 poles + ⊕	111
CSE	10 poles + ⊕	-
CSH	10 poles + ⊕	111
CSH S	10 poles + ⊕	123
CCE	10 poles + ⊕	131
CMSH	3+2 (aux) poles + ⊕	136
CMCE	3+2 (aux) poles + ⊕	137
CSS	10 poles + ⊕	149
CQE	18 poles + ⊕	169
CX	8/24 poles + ⊕	194
MIXO	3 modules	232 - 287

## bulkhead mounting housings



description

part No.

with gasket, size "57.27"

**CGI 10 B**

### CGI B

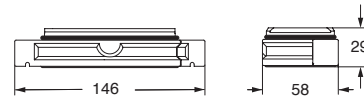

panel cut-out for bulkhead mounting housings

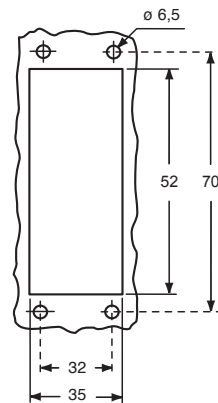

Dust protection cover CGCP FX (from page 697)



**CAUS**® Type 4/4X/12



according to IEC/EN 60529

IP68



# CG and MG high protection IP68 version (bayonet locking)

inserts		page:
CDD	42 poles + ⊕	78
CDS	18 poles + ⊕	-
CDSH	18 poles + ⊕	87
CNE	10 poles + ⊕	111
CSE	10 poles + ⊕	-
CSH	10 poles + ⊕	111
CSH S	10 poles + ⊕	123
CCE	10 poles + ⊕	131
CMSH	3+2 (aux) poles + ⊕	136
CMCE	3+2 (aux) poles + ⊕	137
CSS	10 poles + ⊕	149
CQE	18 poles + ⊕	169
CX	8/24 poles + ⊕	194
MIXO	3 modules	232 - 287

## hoods



## covers



description	part No.	entry Pg	part No	entry M	part No.
with side entry					
size "57.27"	<b>CGO 10.16 B</b>	16	<b>MGO 10.25 B</b>	25	
size "57.27"	<b>CGO 10.21 B</b>	21	<b>MGO 10.32 B</b>	32	
size "57.27"	<b>CGO 10.29 B</b>	29			
with top entry					
size "57.27"	<b>CGV 10.16 B</b>	16	<b>MGV 10.25 B</b>	25	
size "57.27"	<b>CGV 10.21 B</b>	21	<b>MGV 10.32 B</b>	32	
size "57.27"	<b>CGV 10.29 B</b>	29	<b>MGV 10.40 B</b>	40	

## CGC 10 B

### CGO/MGO B and CGV/MGV B

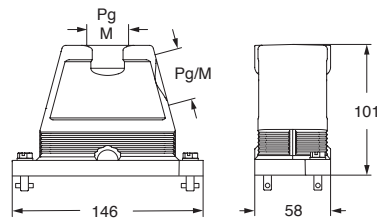

### CGC B

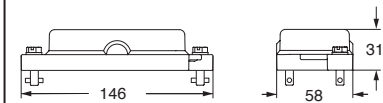

Dust protection cover CGCP MB (from page 697)



**CE** <sup>®</sup> **US** Type 4/4X/12



according to IEC/EN 60529

# CG and MG high protection IP68 version (screw locking)

inserts		page:
CD	40 poles + ⊕	70
CDD	72 poles + ⊕	79
CDS	27 poles + ⊕	-
CDSH	27 poles + ⊕	88
CNE	16 poles + ⊕	112
CSE	16 poles + ⊕	-
CSH	16 poles + ⊕	112
CSH S	16 poles + ⊕	124
CCE	16 poles + ⊕	132
CMSH, CMCE	6+2 (aux) poles + ⊕	138 - 139
CSS	16 poles + ⊕	150
CQE	32 poles + ⊕	170
CQEE	40 poles + ⊕	176
CP	6 poles + ⊕	178
CX	6/12, 6/36 and 12/2 poles + ⊕	197 - 199
CX	4/0 and 4/2 poles + ⊕	200 - 201
MIXO	4 modules	232 - 287

## bulkhead mounting housings



## surface mounting housings



description	part No.	part No.	entry Pg	part No.	entry M
with gasket, size "77.27"	<b>CGI 16</b>				
size "77.27"		<b>CGP 16.36</b>	36	<b>MGP 16.40</b>	40

### CGI

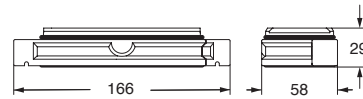

panel cut-out for bulkhead mounting housings

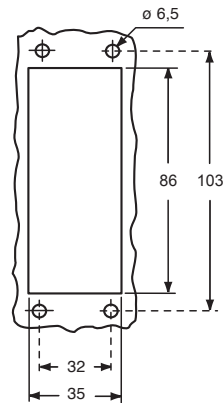

### CGP and MGP

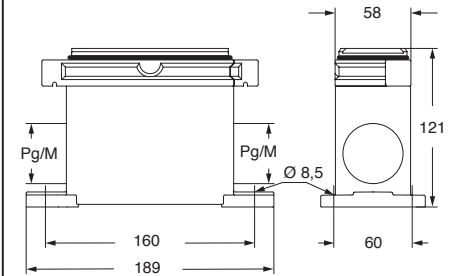

Dust protection cover CGCP FX (from page 697)



**CAUS** Type 4/4X/12



according to IEC/EN 60529

# CG and MG high protection IP68 version (screw locking)

inserts		page:
CD	40 poles + ⊕	70
CDD	72 poles + ⊕	79
CDS	27 poles + ⊕	-
CDSH	27 poles + ⊕	88
CNE	16 poles + ⊕	112
CSE	16 poles + ⊕	-
CSH	16 poles + ⊕	112
CSH S	16 poles + ⊕	124
CCE	16 poles + ⊕	132
CMSH, CMCE	6+2 (aux) poles + ⊕	138 - 139
CSS	16 poles + ⊕	150
CQE	32 poles + ⊕	170
CQEE	40 poles + ⊕	176
CP	6 poles + ⊕	178
CX	6/12, 6/36 and 12/2 poles + ⊕	197 - 199
CX	4/0 and 4/2 poles + ⊕	200 - 201
MIXO	4 modules	232 - 287

## hoods



## covers



description	part No.	entry Pg	part No	entry M	part No.
with side entry					
size "77.27"	<b>CGO 16.21</b>	21	<b>MGO 16.32</b>	32	
size "77.27"	<b>CGO 16.29</b>	29	<b>MGO 16.40</b>	40	
size "77.27"	<b>CGO 16.36</b>	36	<b>MGO 16.50</b>	50	
with top entry					
size "77.27"			<b>MGV 16.25</b>	25	
size "77.27"			<b>MGV 16.225</b>	25 x 2	
size "77.27"	<b>CGV 16.21</b>	21	<b>MGV 16.32</b>	32	
size "77.27"	<b>CGV 16.221</b>	21 x 2			
size "77.27"	<b>CGV 16.29</b>	29	<b>MGV 16.40</b>	40	
size "77.27"	<b>CGV 16.36</b>	36	<b>MGV 16.50</b>	50	

## CGC 16

### CGO/MGO and CGV/MGV

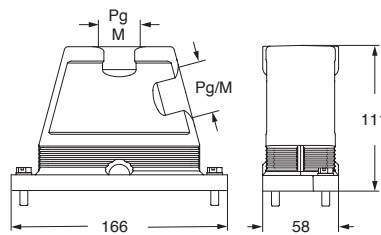

### CGC

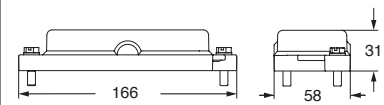

Dust protection cover CGCP MB (from page 697)



**CUUS** Type 4/4X/12



according to IEC/EN 60529

# CG high protection IP68 version (bayonet locking)

inserts		page:
CD	40 poles + ⊕	70
CDD	72 poles + ⊕	79
CDS	27 poles + ⊕	-
CDSH	27 poles + ⊕	88
CNE	16 poles + ⊕	112
CSE	16 poles + ⊕	-
CSH	16 poles + ⊕	112
CSH S	16 poles + ⊕	124
CCE	16 poles + ⊕	132
CMSH, CMCE	6+2 (aux) poles + ⊕	138 - 139
CSS	16 poles + ⊕	150
CQE	32 poles + ⊕	170
CQEE	40 poles + ⊕	176
CP	6 poles + ⊕	178
CX	6/12, 6/36 and 12/2 poles + ⊕	197 - 199
CX	4/0 and 4/2 poles + ⊕	200 - 201
MIXO	4 modules	232 - 287

## bulkhead mounting housings



description

part No.

with gasket, size "77.27"

**CGI 16 B**

### CGI B

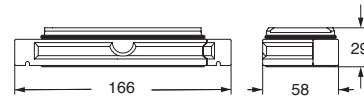

panel cut-out for bulkhead mounting housings

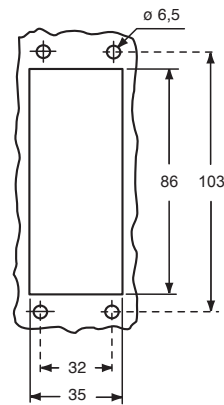

Dust protection cover CGCP FX (from page 697)



**CAUS**® Type 4/4X/12



according to IEC/EN 60529

IP68

# CG and MG high protection IP68 version (bayonet locking)

inserts		page:
CD	40 poles + ⊕	70
CDD	72 poles + ⊕	79
CDS	27 poles + ⊕	-
CDSH	27 poles + ⊕	88
CNE	16 poles + ⊕	112
CSE	16 poles + ⊕	-
CSH	16 poles + ⊕	112
CSH S	16 poles + ⊕	124
CCE	16 poles + ⊕	132
CMSH, CMCE	6+2 (aux) poles + ⊕	138 - 139
CSS	16 poles + ⊕	150
CQE	32 poles + ⊕	170
CQEE	40 poles + ⊕	176
CP	6 poles + ⊕	178
CX	6/12, 6/36 and 12/2 poles + ⊕	197 - 199
CX	4/0 and 4/2 poles + ⊕	200 - 201
MIXO	4 modules	232 - 287

## hoods



## covers



description	part No.	entry Pg	part No	entry M	part No.
with side entry					
size "77.27"	<b>CGO 16.21 B</b>	21	<b>MGO 16.32 B</b>	32	
size "77.27"	<b>CGO 16.29 B</b>	29	<b>MGO 16.40 B</b>	40	
size "77.27"	<b>CGO 16.36 B</b>	36	<b>MGO 16.50 B</b>	50	
with top entry					
size "77.27"			<b>MGV 16.25 B</b>	25	
size "77.27"			<b>MGV 16.225 B</b>	25 x 2	
size "77.27"	<b>CGV 16.21 B</b>	21	<b>MGV 16.32 B</b>	32	
size "77.27"	<b>CGV 16.221 B</b>	21 x 2			
size "77.27"	<b>CGV 16.29 B</b>	29	<b>MGV 16.40 B</b>	40	
size "77.27"	<b>CGV 16.36 B</b>	36	<b>MGV 16.50 B</b>	50	
size "77.27"					<b>CGC 16 B</b>

### CGO/MGO B and CGV/MGV B

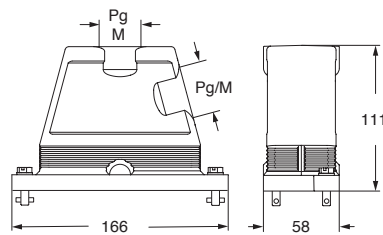

### CGC B

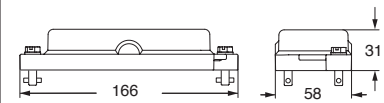

Dust protection cover CGCP MB (from page 697)



**CUUS** Type 4/4X/12



according to IEC/EN 60529

# CG and MG high protection IP68 version (screw locking)

inserts		page:
CD	64 poles + ⊕	72
CDD	108 poles + ⊕	81
CDS	42 poles + ⊕	-
CDSH	42 poles + ⊕	89
CNE	24 poles + ⊕	113
CSE	24 poles + ⊕	-
CSH	24 poles + ⊕	113
CSH S	24 poles + ⊕	125
CCE	24 poles + ⊕	133
CMSH	10+2 (aux) poles + ⊕	140
CMCE	10+2 (aux) poles + ⊕	141
CSS	24 poles + ⊕	151
CQE	46 poles + ⊕	171
CQEE	64 poles + ⊕	177
CX	4/8 and 6/6 poles + ⊕	204 and 206
MIXO	6 modules	232 - 287

## bulkhead mounting housings



## surface mounting housings



description	part No.	part No.	entry Pg	part No.	entry M
with gasket, size "104.27"	<b>CGI 24</b>				
size "104.27"		<b>CGP 24.36</b>	36	<b>MGP 24.40</b>	40
size "104.27"		<b>CGP 24.236</b>	36 x 2	<b>MGP 24.240</b>	40 x 2

### CGI

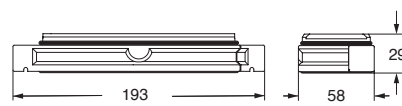

panel cut-out for bulkhead mounting housings

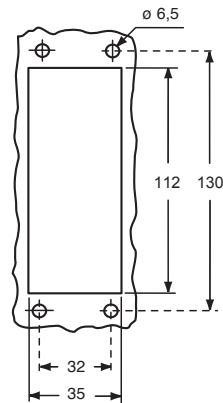

### CGP and MGP

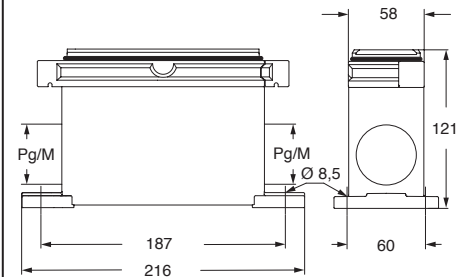

Dust protection cover CGCP FX (from page 697)



**CAUS** Type 4/4X/12



according to IEC/EN 60529

IP68



# CG and MG high protection IP68 version (screw locking)

inserts		page:
CD	64 poles + ⊕	72
CDD	108 poles + ⊕	81
CDS	42 poles + ⊕	-
CDSH	42 poles + ⊕	89
CNE	24 poles + ⊕	113
CSE	24 poles + ⊕	-
CSH	24 poles + ⊕	113
CSH S	24 poles + ⊕	125
CCE	24 poles + ⊕	133
CMSH	10+2 (aux) poles + ⊕	140
CMCE	10+2 (aux) poles + ⊕	141
CSS	24 poles + ⊕	151
CQE	46 poles + ⊕	171
CQEE	64 poles + ⊕	177
CX	4/8 and 6/6 poles + ⊕	204 and 206
MIXO	6 modules	232 - 287

## hoods



## covers



description	part No.	entry Pg	part No	entry M	part No.
with side entry					
size "104.27"	<b>CGO 24.21</b>	21	<b>MGO 24.32</b>	32	
size "104.27"	<b>CGO 24.29</b>	29	<b>MGO 24.40</b>	40	
size "104.27"	<b>CGO 24.36</b>	36	<b>MGO 24.50</b>	50	
with top entry					
size "104.27"			<b>MGVE 24.325</b>	25 x 3	
size "104.27"	<b>CGV 24.21</b>	21	<b>MGV 24.32</b>	32	
size "104.27"			<b>MGV 24.232</b>	32 x 2	
size "104.27"	<b>CGV 24.29</b>	29	<b>MGV 24.40</b>	40	
size "104.27"	<b>CGV 24.229</b>	29 x 2	<b>MGV 24.240</b>	40 x 2	
size "104.27"	<b>CGV 24.36</b>	36	<b>MGV 24.50</b>	50	
size "104.27"					<b>CGC 24</b>

### CGO/MGO and CGV/MGV

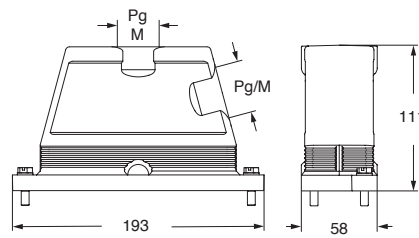

### CGC

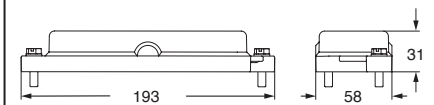

Dust protection cover CGCP MB (from page 697)



**CUUS** Type 4/4X/12



according to IEC/EN 60529

# CG high protection IP68 version (bayonet locking)

inserts		page:
CD	64 poles + ⊕	72
CDD	108 poles + ⊕	81
CDS	42 poles + ⊕	-
CDSH	42 poles + ⊕	89
CNE	24 poles + ⊕	113
CSE	24 poles + ⊕	-
CSH	24 poles + ⊕	113
CSH S	24 poles + ⊕	125
CCE	24 poles + ⊕	133
CMSH	10+2 (aux) poles + ⊕	140
CMCE	10+2 (aux) poles + ⊕	141
CSS	24 poles + ⊕	151
CQE	46 poles + ⊕	171
CQEE	64 poles + ⊕	177
CX	4/8 and 6/6 poles + ⊕	204 and 206
MIXO	6 modules	232 - 287

## bulkhead mounting housings



description

part No.

with gasket, size "77.27"

**CGI 24 B**

### CGI B

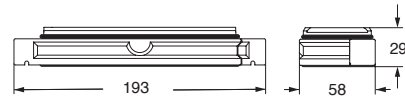

panel cut-out for bulkhead mounting housings

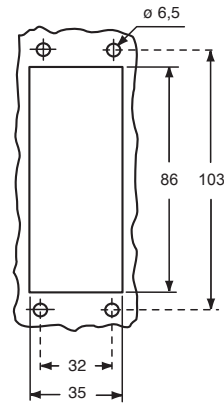

Dust protection cover CGCP FX (from page 697)



**CAUS**® Type 4/4X/12



according to IEC/EN 60529

IP68

# CG and MG high protection IP68 version (bayonet locking)

inserts		page:
CD	64 poles + ⊕	72
CDD	108 poles + ⊕	81
CDS	42 poles + ⊕	-
CDSH	42 poles + ⊕	89
CNE	24 poles + ⊕	113
CSE	24 poles + ⊕	-
CSH	24 poles + ⊕	113
CSH S	24 poles + ⊕	125
CCE	24 poles + ⊕	133
CMSH	10+2 (aux) poles + ⊕	140
CMCE	10+2 (aux) poles + ⊕	141
CSS	24 poles + ⊕	151
CQE	46 poles + ⊕	171
CQEE	64 poles + ⊕	177
CX	4/8 and 6/6 poles + ⊕	204 and 206
MIXO	6 modules	232 - 287

## hoods



## covers



description	part No.	entry Pg	part No.	entry M	part No.
with side entry					
size "104.27"	<b>CGO 24.21 B</b>	21	<b>MGO 24.32 B</b>	32	
size "104.27"	<b>CGO 24.29 B</b>	29	<b>MGO 24.40 B</b>	40	
size "104.27"	<b>CGO 24.36 B</b>	36	<b>MGO 24.50 B</b>	50	
with top entry					
size "104.27"			<b>MGV 24.325 B</b>	25 x 3	
size "104.27"	<b>CGV 24.21 B</b>	21	<b>MGV 24.32 B</b>	32	
size "104.27"			<b>MGV 24.232 B</b>	32 x 2	
size "104.27"	<b>CGV 24.29 B</b>	29	<b>MGV 24.40 B</b>	40	
size "104.27"	<b>CGV 24.229 B</b>	29 x 2	<b>MGV 24.240 B</b>	40 x 2	
size "104.27"	<b>CGV 24.36 B</b>	36	<b>MGV 24.50 B</b>	50	
size "104.27"					<b>CGC 24 B</b>

Dust protection cover CGCP MB (from page 697)



### CGO/MGO B and CGV/MGV B

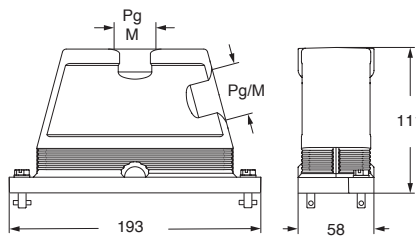

### CGC B

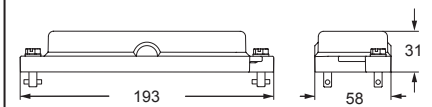

**CUUS** Type 4/4X/12



according to IEC/EN 60529

# CG..FL counterflanges high protection IP68 version

bulkhead mounting housings:

- size "44.27"
- size "57.27"
- size "77.27"
- size "104.27"

page:

- 632 - 635
- 636 - 639
- 640 - 643
- 644 - 647

counterflanges  
for bulkhead mounting housings



description

part No.

- size "44.27"
- size "57.27"
- size "77.27"
- size "104.27"

- CG 06 FL**
- CG 10 FL**
- CG 16 FL**
- CG 24 FL**

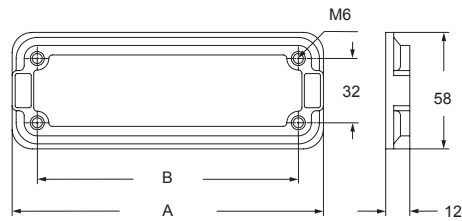

part No.	A	B
<b>CG 06 FL</b>	96	70
<b>CG 10 FL</b>	109	83
<b>CG 16 FL</b>	129	103
<b>CG 24 FL</b>	156	130

IP68



# COB series

## Functionality counts

The **COB** system of panel supports makes it possible to use multipole connectors within electric panels without the traditional metallic enclosures as protection is assured by the electric panel itself or other container.

**N.B.:** connectors must not be connected and disconnected under load or when live.

The **COB** system is approved by **UL** as support for multipole connectors (UL ECBT2 and ECBT8 file E115072), as well as by **DNV-GL** and **Bureau Veritas** maritime applications on board ships.

The **COB** system may be assembled in the three following ways:

- On panels with window snap fastening device (**Figure 1**).
- On DIN EN 60715 rails, both lengthways and crossways to the support (**Figure 2**).
- On fixed panels using screws (**Figure 2**).

The **COB** system offers the following advantages:

- Reduction in cost and space with respect to metallic enclosures plus traditional terminal blocks enabling "modular" wiring inside panels, very handy in case of maintenance: fast replacement of devices and entire sections leading to shorter downtime.
- Possibility of pre-wiring and testing of the connectors at bench, fastening the commissioning of the installation on site.
- Easy wiring inspection and tests with coupled connectors, thanks to rear access to the inserts by the overturning (connector hinged and locked on the base support).
- Fast mounting in panels thanks to the snap fastening device on the DIN EN 60715 rails.
- Sturdy support structure, specific to the size of each insert, it does not require any preparation.
- Broad passage for housing of conductor cables.

Supports for connector inserts

types	COB TCQ			
	fixed	COB 06 BC	COB 10 BC	COB 16 BC
types	COB TSF and COB TSFS			
	mobile	COB 06 CMS	COB 10 CMS	COB 16 CMS

Insert centre distance

mm	44 x 27	57 x 27	49.5 x 16 * 66 x 16 *	77.5 x 27	104 x 27

Insert series and polarity + ⊕

CD			15 *, 25 *, 40	64
CDD	24	42	38 *, 72	108
CDA, CSAH			10 *, 16 *	
CDC			10 *, 16 *	
CDSH, CDS	9	18	27	42
CCE	6	10	16	24
CQE	10	18	32	46
CQEE			40	64
CNE	6	10	16	24
CSH, CSE	6	10	16	24
CMCE		3 + 2	6 + 2	10 + 2 16 + 2
CME		3 + 2	6 + 2	10 + 2 16 + 2
CMSH		3 + 2	6 + 2	10 + 2
CP			6	
CX			4/0, 4/2	4/8
			6/36, 12/2	6/6
MIXO	2 modules	3 modules	4 modules	6 modules

- Mobile parts prearranged for the clamping of bundles of conductors of multi-core cables, to prevent contact with the connector contacts.

The **COB** system satisfies the most varied installation needs thanks to the interchangeability of the connector inserts. The inserts can be installed as per the table here under.

In addition, the **COB...BC** supports may house the **ILME CR...AD1** and **CR...AD2** series plates for the D-SUB inserts (miniature-connectors).

**Figure 1: COB TCQ + COB TSFS (COB...CMS, alternative)**

- Snap fastening in window (mounting via adaptor plates described on page 654), panels or control panels.

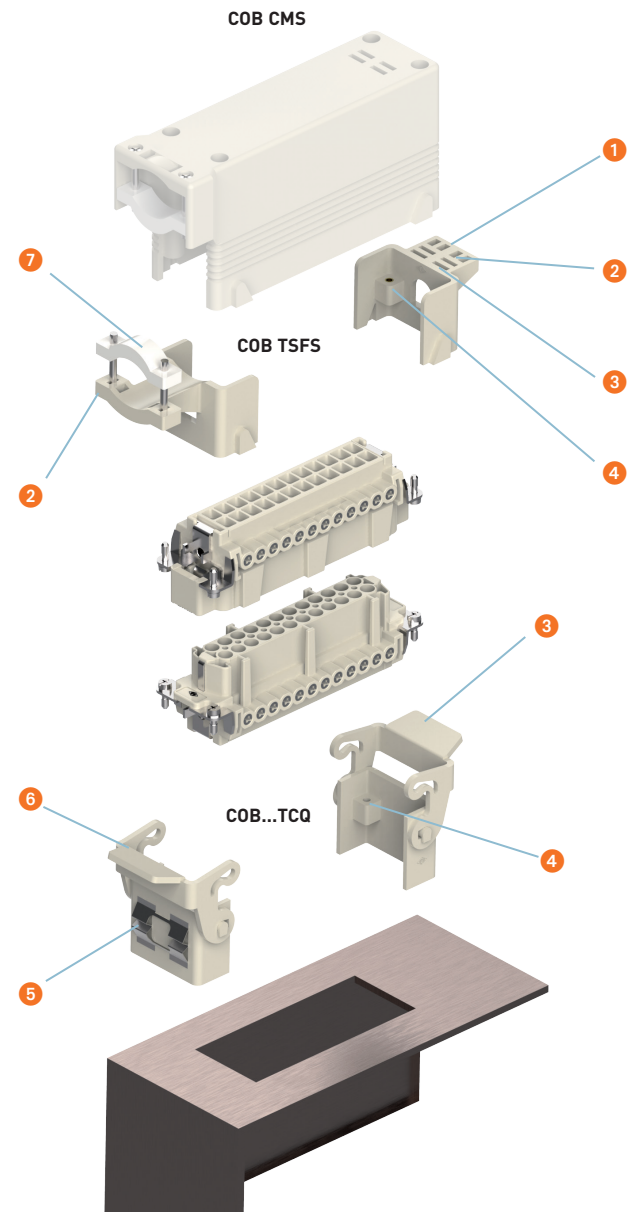

## Product details

- 1 **COB, TSF** or **COB TSFS** insert support blocks (with cable clamp) for mobile mounting, in self-extinguishing thermoplastic material.
- 2 Passage for cable support bands (from 2,2 to 4,8 mm).
- 3 Locations for insertion of identification tags (size 9 x 20 mm).
- 4 Threaded metallic inserts for screws to fix the connectors and possibility of coded connection with the use of specific pins (ILME part: CR 20, CRM, CRF, CR 20 CX, CRM CX and CRF CX) when identical connectors are used.
- 5 **COB TCQ** insert carrier block for window mounting in self-extinguishing thermoplastic material, with spring snap fastening.
- 6 Locking device with levers in self-extinguishing thermoplastic material for insert coupling.
- 7 Sturdy cable clamp for clamping multipolar cables with a diameter of up to 25 mm or bundles of unipolar conductors.
- 8 **COB...CMS** enclosure for mobile mounting, in self-extinguishing thermoplastic material, IP20 degree of protection.
- 9 Free passage for mounting wired insert with conductor cables.
- 10 Mobile blocks (in **COB...BC** kit) in self-extinguishing thermoplastic material, with quick release device for insert turnover, wiring operations, verifications and maintenance
- 11 **COB...BC** panel support for bulkhead mounting in self-extinguishing thermoplastic material, sturdy block support structure, with broad passage for housing of conductor cables.
- 12 Holes for fixed fastening with screws without DIN EN 60715 rails.
- 13 Snap fastening on DIN EN 60715 rails, both lengthways and crossways to the support.
- 14 Rollover pins that can be released and allow the use of pre-wired inserts.

**Figure 2: COB...BC + COB...CMS (COB TSF, alternative)**

- snap fastening on DIN EN 60715 rails both lengthways and crossways to the support
- installation in panels or control panels, with fixed fastening with screws.

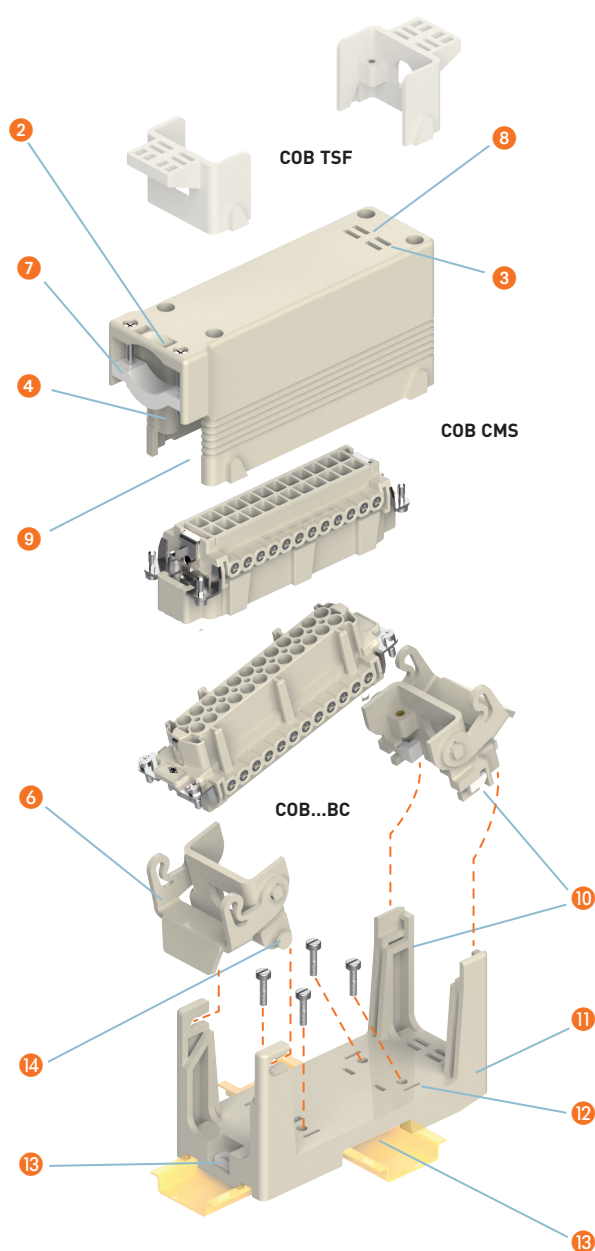



# COB panel supports for multipole connectors

inserts		page:
CD	40, 64 poles + ⊕	70 and 72
CDD	24, 42, 72, 108 poles + ⊕	76 - 81
CDS	9, 18, 27, 42 poles + ⊕	-
CDSH	9, 18, 27, 42 poles + ⊕	86 - 89
CDSH NC	6 poles + ⊕	95
CNE	6, 10, 16, 24 poles + ⊕	110 - 113
CSE	6, 10, 16, 24 poles + ⊕	-
CSH	6, 10, 16, 24 poles + ⊕	110 - 113
CSH S	6, 10, 16, 24 poles + ⊕	122 - 125
CCE	6, 10, 16, 24 poles + ⊕	130 - 133
CME	3+2, 6+2, 10+2 (aux) poles + ⊕	136 - 140
CMSH	3+2, 6+2, 10+2 (aux) poles + ⊕	136 - 140
CMCE	3+2, 6+2, 10+2 (aux) poles + ⊕	137 - 141
CSS	6, 10, 16, 24 poles + ⊕	148 - 151
CQE	10, 18, 32, 46 poles + ⊕	168 - 171
CQEE	40, 64 poles + ⊕	176 - 177
CP	6 poles + ⊕	178
CX	8/24, 6/36, 12/2 poles + ⊕	194 - 199
CX	4/0, 4/2, 4/8, 6/6 poles + ⊕	200 - 206
MIXO	2, 3, 4, 6 modules	232 - 287

## connector carrier for faceplate mounting in window, snap fastening



## connector carrier baseplate for mounting on DIN EN 60715 rail or fixed mounting using screws

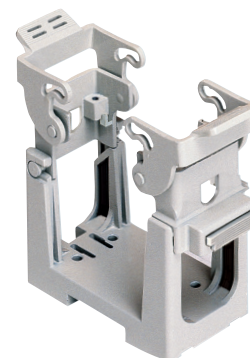

description

part No.

part No.

kit with 2 elements, for coupling of inserts with screw fixing centre distance (short side = 27 mm)

### COB TCQ

kit comprising frame and mobile blocks, for insert coupling: with screw fixing centre distance of 44 x 27 mm with screw fixing centre distance of 57 x 27 mm with screw fixing centre distance of 77,5 x 27 mm with screw fixing centre distance of 104 x 27 mm

- COB 06 BC
- COB 10 BC
- COB 16 BC
- COB 24 BC

It is the responsibility of the installer to verify the continuity of the PE protective earth circuit ⊕ between the two halves of the connector.

Optional PE earth jumpers (page 655)

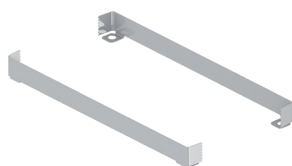

### COB TCQ

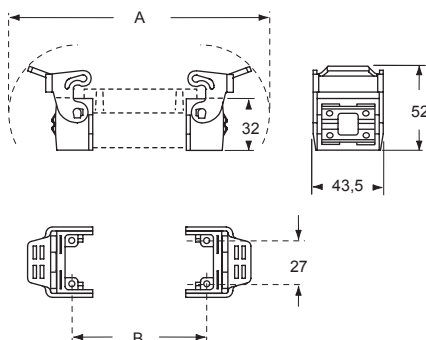

#### COB TCQ

for inserts	A	B
with centre distance 44 x 27 mm	120	44
with centre distance 57 x 27 mm	133	57
with centre distance 77,5 x 27 mm	153,5	77,5
with centre distance 104 x 27 mm	180	104

### panel cut-out COB TCQ

window size on plate thickness 1,3-3 mm

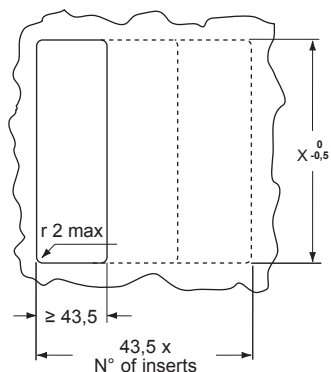

for insert coupling:	X 0,5
with centre distance 44 x 27 mm	65
with centre distance 57 x 27 mm	78
with centre distance 77,5 x 27 mm	98
with centre distance 104 x 27 mm	125

### COB BC

overall dimensions with longitudinal DIN rails

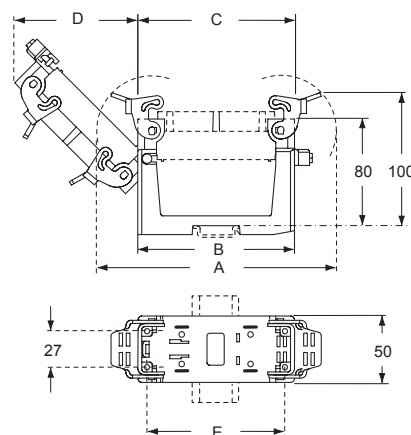

part No.	A	B	C	D	E
COB 06 BC	120	91,5	58	50	44
COB 10 BC	133	91,5	71	59,5	57
COB 16 BC	153,5	91,5	91,5	74	77,5
COB 24 BC	180	118	118	93	104

### panel cut-out COB BC

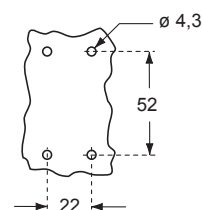

overall dimensions without DIN rails (values with "asterisk") overall dimensions with longitudinal DIN rails

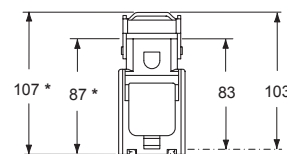

# COB panel supports for multipole connectors

inserts		page:
CD	40, 64 poles + ⊕	70 and 72
CDD	24, 42, 72, 108 poles + ⊕	76 - 81
CDS	9, 18, 27, 42 poles + ⊕	-
CDSH	9, 18, 27, 42 poles + ⊕	86 - 89
CDSH NC	6 poles + ⊕	95
CNE	6, 10, 16, 24 poles + ⊕	110 - 113
CSE	6, 10, 16, 24 poles + ⊕	-
CSH	6, 10, 16, 24 poles + ⊕	110 - 113
CSH S	6, 10, 16, 24 poles + ⊕	122 - 125
CCE	6, 10, 16, 24 poles + ⊕	130 - 133
CME	3+2, 6+2, 10+2 (aux) poles + ⊕	136 - 140
CMSH	3+2, 6+2, 10+2 (aux) poles + ⊕	136 - 140
CMCE	3+2, 6+2, 10+2 (aux) poles + ⊕	137 - 141
CS	6, 10, 16, 24 poles + ⊕	148 - 151
CQE	10, 18, 32, 46 poles + ⊕	168 - 171
CQEE	40, 64 poles + ⊕	176 - 177
CP	6 poles + ⊕	178
CX	8/24, 6/36, 12/2 poles + ⊕	194 - 199
CX	4/0, 4/2, 4/8, 6/6 poles + ⊕	200 - 206
MIXO	2, 3, 4, 6 modules	232 - 287

## insert carrier blocks for mobile mounting



## insert carrier insulated enclosures for mobile mounting

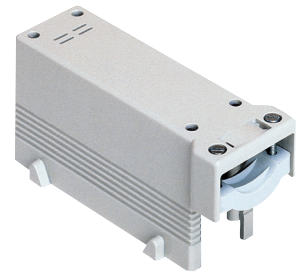

description	part No.	part No.
-------------	----------	----------

kit with 2 elements, for coupling of inserts with screw fixing centre distance (short side = 27 mm) with handle for cable support bands with handle for cable support or cable clamp bands

**COB TSF**  
**COB TSFS**

side entry, with cable clamp

for insert coupling:

- with screw fixing centre distance of 44 x 27 mm
- with screw fixing centre distance of 57 x 27 mm
- with screw fixing centre distance of 77,5 x 27 mm
- with screw fixing centre distance of 104 x 27 mm

**COB 06 CMS**  
**COB 10 CMS**  
**COB 16 CMS**  
**COB 24 CMS**

It is the responsibility of the installer to verify the continuity of the PE protective earth circuit ⊕ between the two halves of the connector.

**Optional PE earth jumpers (page 655)**

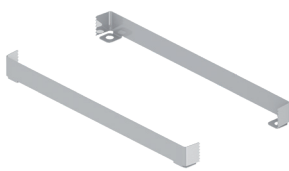

### COB TSF

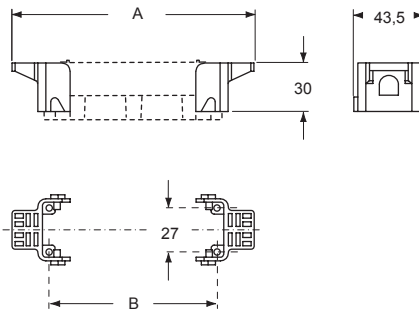

### COB TSFS

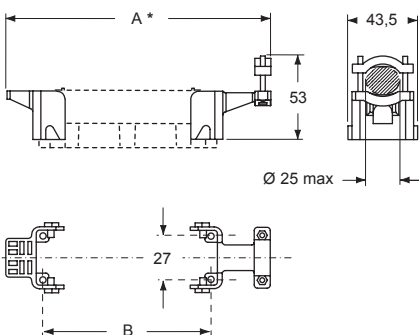

### COB CMS

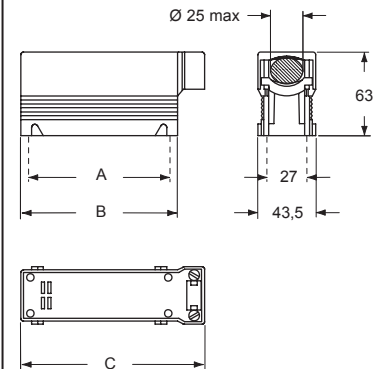

part No.	A	B	C
<b>COB 06 CMS</b>	44	58	74
<b>COB 10 CMS</b>	57	71	87
<b>COB 16 CMS</b>	77,5	91,5	107,5
<b>COB 24 CMS</b>	104	118	134

for inserts	A	A*	B
with centre distance 44 x 27 mm	90	104	44
with centre distance 57 x 27 mm	103	117	57
with centre distance 77,5 x 27 mm	123,5	137,5	77,5
with centre distance 104 x 27 mm	150	164	104

# COB panel supports for multipole connectors

inserts		page:
CD	15, 25 poles + ⊕	68 - 69
CDD	38 poles + ⊕	77
CSAH	10, 16 poles + ⊕	99 - 101
CDA	10, 16 poles + ⊕	98 - 100
CDC	10, 16 poles + ⊕	104 - 105
MIXO	1 module	232 - 287

## adaptor plates for insert mounting

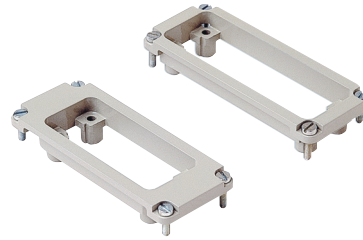

## levers for coupling with metallic enclosures



description	part No.	part No.
-------------	----------	----------

mounting on COB series articles (see below)  
for 1 insert with centre distance of 49,5 x 16 mm

**CR 15/16**

mounting on COB series articles (see below)  
for 1 insert with centre distance of 66 x 16 mm

**CR 25/16**

kit with 2 elements, to be mounted instead of the standard  
levers to be coupled with: COB TCQ and COB...BC <sup>1)</sup>

**COB L**

<sup>1)</sup> They allow the mounting of aluminium hoods with  
4 pegs, size 55.27, 77.27 and 104.27

### Adaptor plates

They allow the inserting of inserts of "49.16" and  
"66.16" on the following COB series articles:  
COB TCQ, COB 16 BC, COB TSF, COB TSFS,  
COB 16 CMS

It is the responsibility of the installer to verify the  
continuity of the PE protective earth circuit ⊕  
between the two halves of the connector.

### CR 15/16

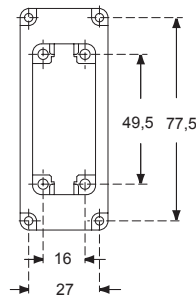

### CR 25/16

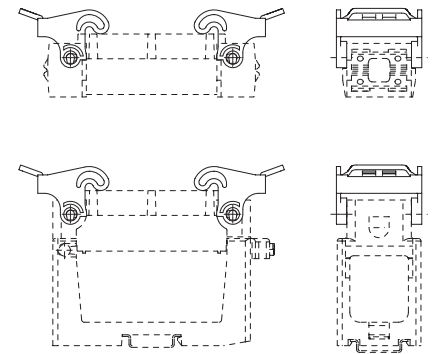
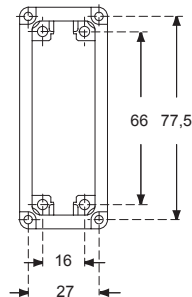

COB

# CR..BPE PE earth jumpers

inserts	page:
<b>CD</b>	40, 64 poles + ⊕ <b>70 and 72</b>
<b>CDD</b>	24, 42, 72, 108 poles + ⊕ <b>76 - 81</b>
<b>CDS</b>	9, 18, 27, 42 poles + ⊕ <b>-</b>
<b>CDSH</b>	9, 18, 27, 42 poles + ⊕ <b>86 - 89</b>
<b>CDSH NC</b>	6 poles + ⊕ <b>95</b>
<b>CNE</b>	6, 10, 16, 24 poles + ⊕ <b>110 - 113</b>
<b>CSE</b>	6, 10, 16, 24 poles + ⊕ <b>-</b>
<b>CSH</b>	6, 10, 16, 24 poles + ⊕ <b>110 - 113</b>
<b>CSH S</b>	6, 10, 16, 24 poles + ⊕ <b>122 - 125</b>
<b>CCE</b>	6, 10, 16, 24 poles + ⊕ <b>130 - 133</b>
<b>CME</b>	3+2, 6+2, 10+2 (aux) poles + ⊕ <b>136 - 140</b>
<b>CMSH</b>	3+2, 6+2, 10+2 (aux) poles + ⊕ <b>136 - 140</b>
<b>CMCE</b>	3+2, 6+2, 10+2 (aux) poles + ⊕ <b>137 - 141</b>
<b>CSS</b>	6, 10, 16, 24 poles + ⊕ <b>148 - 151</b>
<b>CT, CTSE</b>	6, 10, 16, 24 poles + ⊕ <b>160 - 163</b>
<b>CQE</b>	10, 18, 32, 46 poles + ⊕ <b>168 - 171</b>
<b>CQEE</b>	40, 64 poles + ⊕ <b>176 - 177</b>
<b>CP</b>	6 poles + ⊕ <b>178</b>
<b>CX</b>	8/24, 6/36, 12/2 poles + ⊕ <b>194 - 199</b>

## PE optional earth jumpers

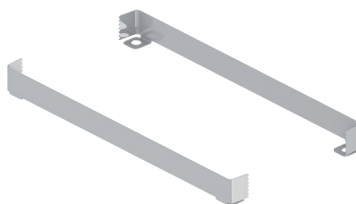

description	part No.
-------------	----------

galvanized brass, to be optionally used with COB series:  
 for inserts "44.27" size  
 for inserts "57.27" size  
 for inserts "77.27" size  
 for inserts "104.27" size

- CR 06 BPE**
- CR 10 BPE**
- CR 16 BPE**
- CR 24 BPE**

CR...BPE accessories PE (protective earth) jumpers could be mounted under the connector inserts for the connection of the two insert's PE plates.

To guarantee to proper alignment of the insert inside the enclosure, it is necessary to use both jumpers supplied (in the same housing or hood); the jumpers are not usable individually.

Furthermore the user is responsible for verifying the continuity of the PE connection ⊕ (male and female) independently of using CR...BPE earth jumpers.

# CH bulkhead connectors

inserts		page:
CD	40, 64 poles + ⊕	70 and 72
CDD	24, 42, 72, 108 poles + ⊕	76 - 81
CDS	9, 18, 27, 42 poles + ⊕	-
CDSH	9, 18, 27, 42 poles + ⊕	86 - 89
CDSH NC	6 poles + ⊕	95
CNE	6, 10, 16, 24 poles + ⊕	110 - 113
CSE	6, 10, 16, 24 poles + ⊕	-
CSH	6, 10, 16, 24 poles + ⊕	110 - 113
CSH S	6, 10, 16, 24 poles + ⊕	122 - 125
CCE	6, 10, 16, 24 poles + ⊕	130 - 133
CME	3+2, 6+2, 10+2 (aux) poles + ⊕	136 - 140
CMSH	3+2, 6+2, 10+2 (aux) poles + ⊕	136 - 140
CMCE	3+2, 6+2, 10+2 (aux) poles + ⊕	137 - 141
CSS	6, 10, 16, 24 poles + ⊕	148 - 151
CQE	10, 18, 32, 46 poles + ⊕	168 - 171
CQEE	40, 64 poles + ⊕	176 - 177
CP	6 poles + ⊕	178
CX	8/24, 6/36, 12/2 poles + ⊕	194 - 199
CX	4/0, 4/2, 4/8, 6/6 poles + ⊕	200 - 206
MIXO	2, 3, 4, 6 modules	232 - 287

## bulkhead mounting housings with 2 or 4 pegs



## bulkhead mounting housings



description	part No.	part No. C-TYPE	part No. C7
size "44.27"	CHI 06 LCH	CHI 06 L	C71 06 L
size "57.27" <sup>1)</sup>	CHI 10 CH	CHI 10	C71 10
size "77.27" <sup>1)</sup>	CHI 16 CH	CHI 16	C71 16
size "104.27" <sup>1)</sup>	CHI 24 CH	CHI 24	C71 24

<sup>1)</sup> may be combined also with enclosures:  
 - surface mounting housings (CHP / MHP...)  
 - hoods with lever and gasket (LG)

panel cut-out for bulkhead mounting housings

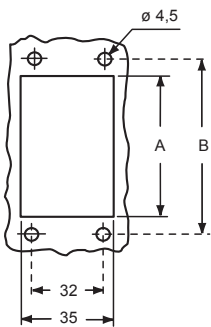

part No.	A	B
CHI 06 LCH - CHI 06 L - C71 06 L	52	70
CHI 10 CH - CHI 10 - C71 10	65	83
CHI 16 CH - CHI 16 - C71 16	86	103
CHI 24 CH - CHI 24 - C71 24	112	130

**N.B.:**  
 The enclosures ensure IP66 degree of protection when mated and locked with the closing levers.

**CAUS** Type 4/4X/12



CHI



C71

### CHI LCH

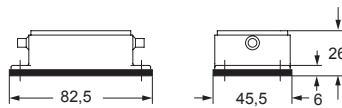

### CHI 10 CH

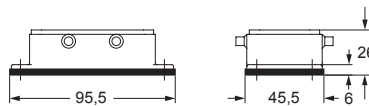

### CHI 16 CH

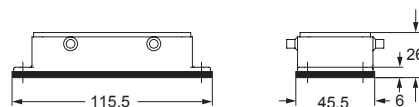

### CHI 16 CH

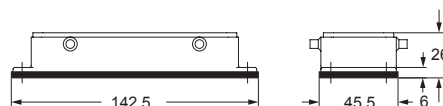

### CHI L

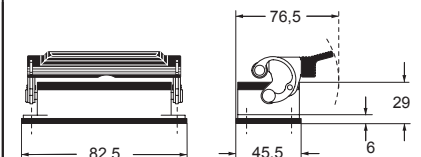

### CHI

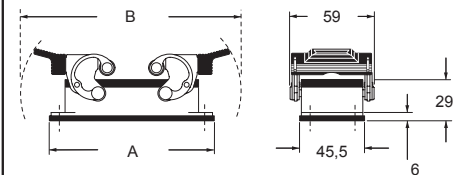

part No.	A	B
CHI 10	95,5	135
CHI 16	115,5	153
CHI 24	142,5	179,5

### C71 L

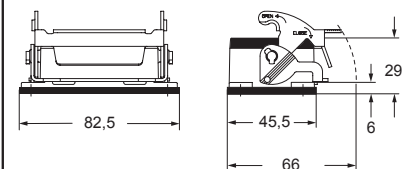

### C71

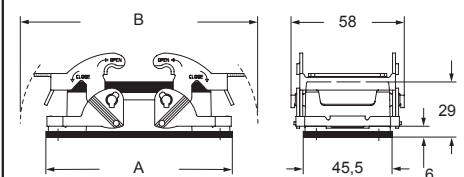

part No.	A	B
C71 10	95,5	122
C71 16	115,5	142,5
C71 24	142,5	169

SPECIAL ENCLOSURES

# CA bottom entry

inserts		page:
CD	64 poles + ⊕	72
CDD	108 poles + ⊕	81
CDS	42 poles + ⊕	-
CDSH	42 poles + ⊕	89
CNE	24 poles + ⊕	113
CSE	24 poles + ⊕	-
CSH	24 poles + ⊕	113
CSH S	24 poles + ⊕	125
CCE	24 poles + ⊕	133
CMSH	10+2 (aux) poles + ⊕	140
CMCE	10+2 (aux) poles + ⊕	141
CSS	24 poles + ⊕	151
CQE	46 poles + ⊕	171
CQEE	64 poles + ⊕	177
CX	4/8 and 6/6 poles + ⊕	204 and 206
MIXO	6 modules	232 - 287

## surface mounting housings with 2 levers, bottom entry



description	part No.	entry Pg
-------------	----------	----------

with levers, high construction, bottom entry with metal adaptor Pg29 (hole) / Pg36 (thread)

**CAP 24 G36** 36

**N.B.:**  
The enclosures ensure IP66 degree of protection when mated and locked with the closing levers.

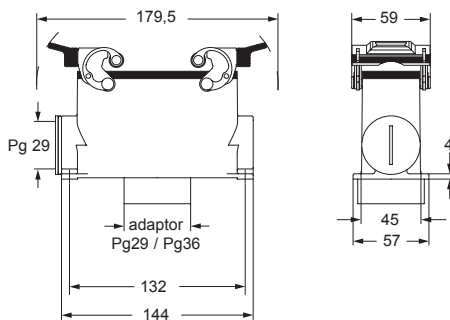

**CAUS**® Type 4/4X/12



SPECIAL ENCLOSURES

# CYR cable passing hoods

enclosures:

size "77.27"  
size "104.27"

**Note:**  
cannot be used with T-TYPE series

## cable passing hoods



description	part No.	size
with pegs for two levers		
3 holes for round cables Ø 5 - 13.5 mm	<b>CYR 16.3</b>	77.27
4 holes for round cables Ø 5 - 13.5 mm	<b>CYR 24.4</b>	104.27

### CYR enclosures for round cables

The CYR enclosures are used in installations that require a passage for round cables for data transmission (e.g. computers or PLC) via equipment such as command or control panels, ensuring a good condition of the cable connections.

The enclosures are in two parts and have sealing gaskets to preserve the degree of protection of the equipment. The enclosures also contain a rapid cable block device.

The CYR 16.3 and 24.4 can be used with the **bulkhead mounting housings with 2 levers** respectively.

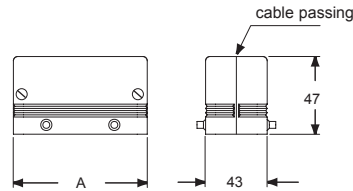

part No.	A	grommet entry	nr.	size
<b>CYR 16.3</b>	93,5	Ø 5 / 13,5	3	77,27
<b>CYR 24.4</b>	120	Ø 5 / 13,5	4	104,27

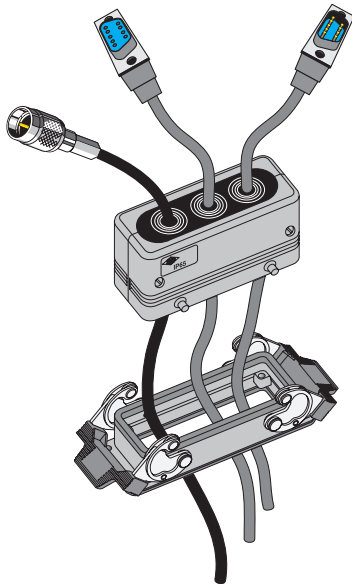

**CAUS**® Type 12



SPECIAL ENCLOSURES



# CYG in-line joints

enclosures:

size "77.27"

**Note:**

cannot be used with T-TYPE series and IP68 series

enclosures for in-line joints



description

part No.

without housings (to be ordered separately)  
made in two halves

**CYG 16**

**CYG 16 in-line joint**

- The joint is made with the CYG 16 enclosure and two bulkhead housings "size 77.27" with one or two levers (to be ordered separately).
- The joint is ideal for use with extension connections and/or as adaptor.
- Made in two halves to facilitate conductor cabling.
- Two inserts in various combinations may be inserted in the joint (to be ordered separately):
  - female/female inserts (as adaptor joint)
  - male/male inserts (as adaptor joint)
  - female/male inserts (as extension joint)

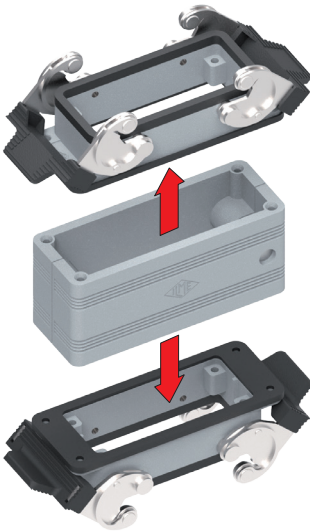
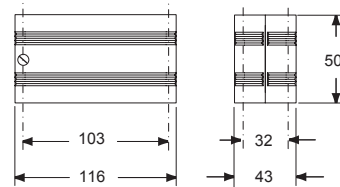

Type  
4/4X/12





# ACCESSORIES AND TOOLS



**LOCKING DEVICE FOR CLASS LOCKING LEVERS ..... 664**

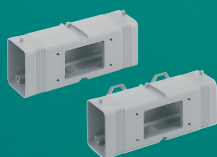

**T-BOX BRANCH COUPLING ..... 666 - 667**



**INSERT FASTENING SCREWS**

**SCREWS FOR SECOND PROTECTIVE EARTH TERMINAL ..... 668**



**ACCESSORIES FOR CT - CTS - CTSE INSERTS ..... 669**

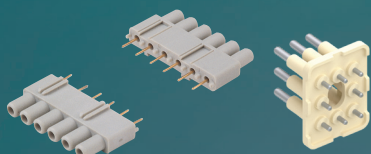

**CIF PCB ADAPTERS ..... 670 - 672**



**CC CRIMP CONTACTS (CONSTANTAN, IRON) ..... 673**

**CD - CDF/M 2D - CDF/M JD (10A)  
CC - CCF/M 2D - CCF/M JD (16A)  
HIGH THICKNESS AND BASIC GOLD  
PLATING CONTACTS ..... 674 - 675**

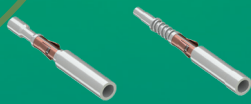

**POF CONTACTS CL SERIES** .....676 - 677

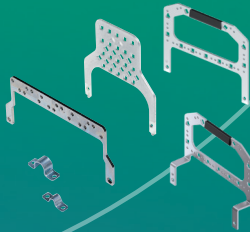

**CR ANCHORAGES** .....678 - 681

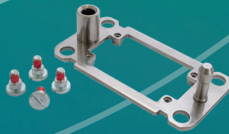

**CR...CF SELF-CENTRING FLOATING FRAME** ..... 682

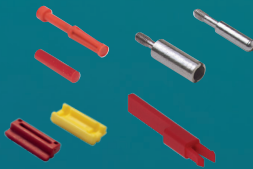

**CR CODING PINS** .....684 - 691



**CKM, CQAM TERMINATION CONNECTOR** .....692 - 693

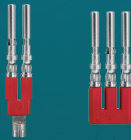

**CR BRIDGES FOR DELTA OR STAR CONNECTION** .....694 - 695

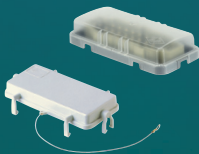

**CHCP, CGKCP, CGCP, PROTECTION COVERS** .....696 - 697



**CBGF INSERT JOINING BLOCK** ..... 698

**CR TM-1 METAL REPLACEMENT HANDLES** ..... 698



**CPT TEMPORARY PROTECTION COVER  
FOR TRANSPORTATION**

**CPES PLIERS FOR UNCOUPLING CONNECTORS ..... 699**

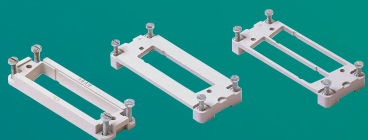

**CR...AD - CR...AD1 - CR...AD2 PLATES  
FOR D-SUB INSERTS..... 700**



**SDS - CHSDS KIT FOR CONTROL EQUIPMENT ..... 701**



**CRH - CRZ CLOSURE AND REDUCTION PLATE ..... 702**



**CX BES EXTRACTION TOOL  
FOR MIXO BUS CONNECTORS ..... 703**



**CRIMPING TOOLS ..... 704 - 741**

## Locking device for CLASS locking levers

### Locking device for bulkhead and surface mounting housings, low profile, with two “Class” locking levers

- **Locking device**, made in **stainless steel**, that can be easily placed on the “Class” locking lever handle of a **two-lever bulkhead mounting housing** or a **“low profile” surface mounting housing** of sizes “57.27”, “77.27” and “104.27”, in order to avoid unwanted and potentially hazardous accidental opening of the locking lever while the connectors are under working condition;
- **possibility to apply, optionally, a padlock** (**TM BLC125**, separately available, 5 mm shackle diameter, 40 mm arc clearance) with **anti-tamper function**, i.e. to secure the locking against unauthorized attempts to open the locking lever and disconnect the connector coupling;
- with eyelet cord end, for fastening the locking device to the intended housing when not in use.

Anti-tamper  
function by  
TM BLC125  
padlock  
(to be ordered  
separately)

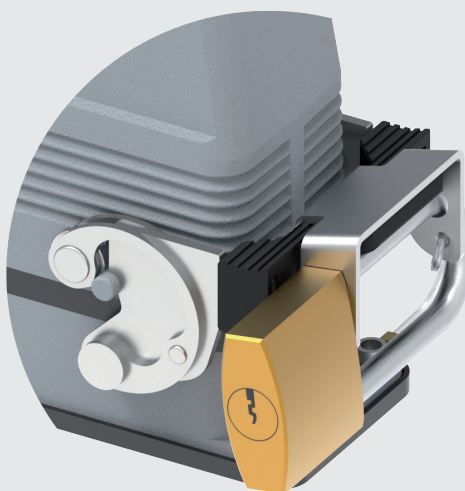

# CR CLK locking device for CLASS locking levers

enclosures	page:	
CHI	10/16/24 poles + ⊕	393, 402, 412
CHP and MHP	10/16/24 poles + ⊕	394, 403, 413

stainless steel locking device  
for two-lever housing

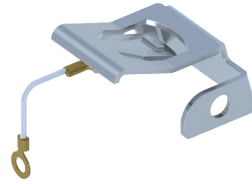

padlock, 40 mm arc clearance,  
optional



description	part No.	part No.
-------------	----------	----------

stainless steel locking device, with eyelet,  
for fixing on the housings

**CR CLK**

padlock (YALE 1130030), supplied with 2 keys

**TM BLC125**

NOTE: Not suitable neither for hoods with locking levers and gasket nor for surface-mounting housings, high profile.

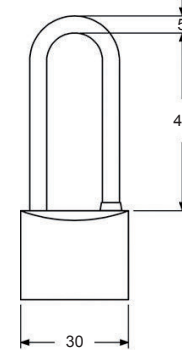
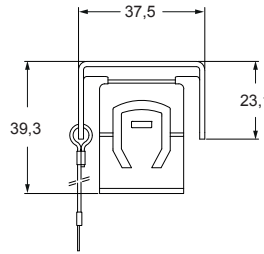
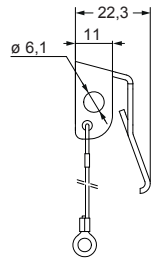

For fixing on housings

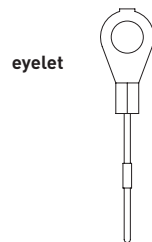

cURus pending



# T-BOX branch coupling

enclosures:

size "44.27"  
size "57.27"

1 branch-off T-BOX coupling

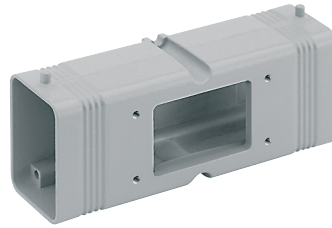

1 branch-off T-BOX coupling to be fitted on DIN rails

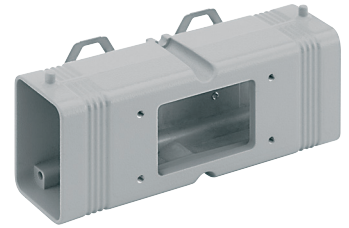

description	part No.	part No.
for 2 <b>C</b> hoods with lever and gasket "44.27" size and one housing "44.27" <b>A</b> size	<b>CYG 06H06</b>	
for 2 <b>C</b> hoods with lever and gasket "44.27" size and one housing "57.27" <b>A</b> size	<b>CYG 06H10</b>	
for 2 <b>C</b> hoods with lever and gasket "44.27" size and one housing "44.27" <b>A</b> size		<b>CYG 06H06D</b>
for 2 <b>C</b> hoods with lever and gasket "44.27" size and one housing "57.27" <b>A</b> size		<b>CYG 06H10D</b>

### How to use the CYG 06H branch coupling

The cables are branched off by using the CYG 06H coupling in the 1 or 2 branch-off versions. Multi-pole inserts "44.27" size can be fitted inside the two side recesses. The entire unit can be used with one lever hoods complete with connector inserts. The front faces can be fitted with "44.27" and/or "57.27" size bulkhead housings. The coupling may also be used as an adapter by using a combination of different insert versions. The CHC 06 LG cover may be used to close the coupling side faces. In the branch-offs, the CSS series dual spring terminal inserts allow two wires to be connected without having to fit additional terminals inside the coupling.

### CYG...H06 / H10

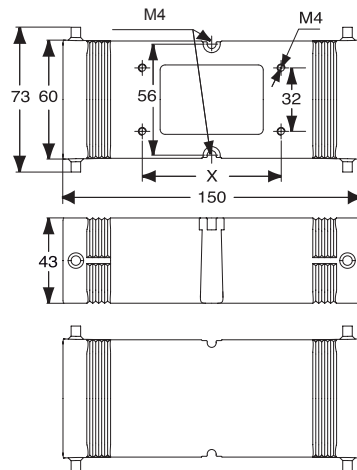

part No.	X
<b>CYG 06H06</b>	70
<b>CYG 06H10</b>	83

### CYG...H06D / H10D

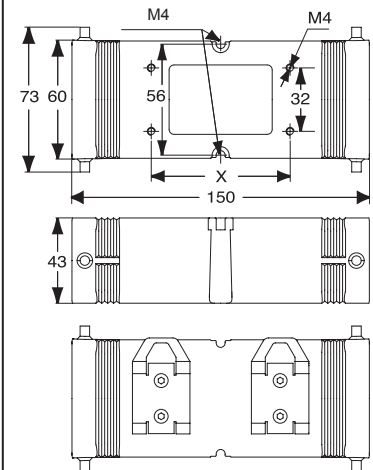

part No.	X
<b>CYG 06H06D</b>	70
<b>CYG 06H10D</b>	83

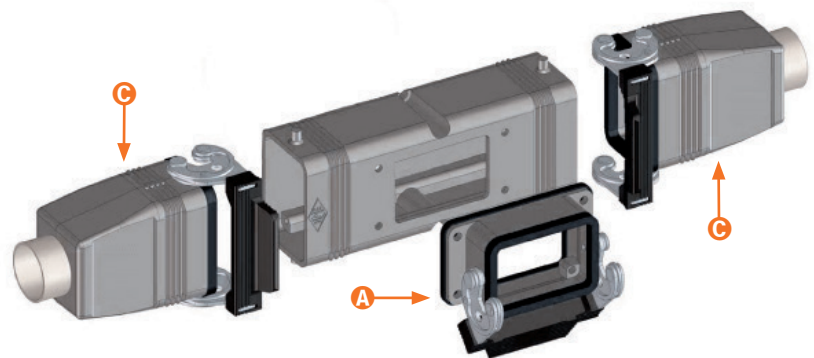

part No.	A	C
<b>CYG 06H06</b>	06	06
<b>CYG 06H10</b>	10	06
<b>CYG 06H06D</b>	06	06
<b>CYG 06H10D</b>	10	06

**Legend:**

- A** bulkhead mounting housings
- C** hoods with lever and gasket (LG)

**CAUS**® Type 4/4X/12



# T-BOX branch coupling

enclosures:

size "44.27"  
size "57.27"

2 branch-off T-BOX coupling

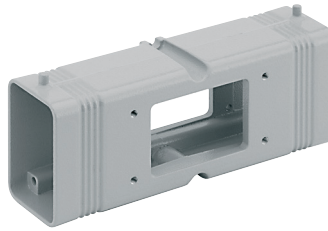

2 branch-off T-BOX coupling

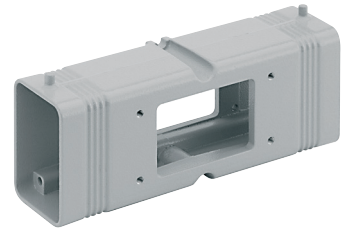

description	part No.	part No.
for 2 <b>C</b> hoods with lever and gasket "44.27" size and one "44.27" <b>B</b> size fixing side housing and one "57.27" <b>A</b> size housing	<b>CYG 06H0610</b>	
for 2 <b>C</b> hoods with lever and gasket "44.27" size and one "57.27" <b>B</b> size fixing side housing and one "44.27" <b>A</b> size enclosure	<b>CYG 06H1006</b>	
for 2 <b>C</b> hoods with lever and gasket "44.27" size and two "44.27" <b>A</b> and <b>B</b> size housing		<b>CYG 06H0606</b>
for 2 <b>C</b> hoods with lever and gasket "44.27" size and two "57.27" <b>A</b> and <b>B</b> size housing		<b>CYG 06H1010</b>

### How to use the CYG 06H branch coupling

The cables are branched off by using the CYG 06H coupling in the 1 or 2 branch-off versions. Multi-pole inserts "44.27" size can be fitted inside the two side recesses. The entire unit can be used with one lever hoods complete with connector inserts. The front faces can be fitted with "44.27" and/or "57.27" size bulkhead housings. The coupling may also be used as an adapter by using a combination of different insert versions. The CHC 06 LG cover may be used to close the coupling side faces. In the branch-offs, the CSS series dual spring terminal inserts allow two wires to be connected without having to fit additional terminals inside the coupling.

CYG...H0610 / H1006

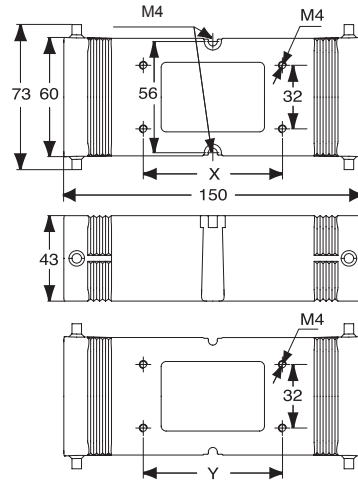

part No.	X	Y
<b>CYG 06H0610</b>	83	70
<b>CYG 06H1006</b>	70	83

CYG...H0606 / H1010

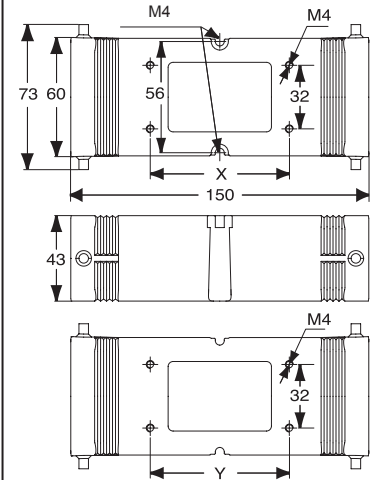

part No.	X	Y
<b>CYG 06H0606</b>	70	70
<b>CYG 06H1010</b>	83	83

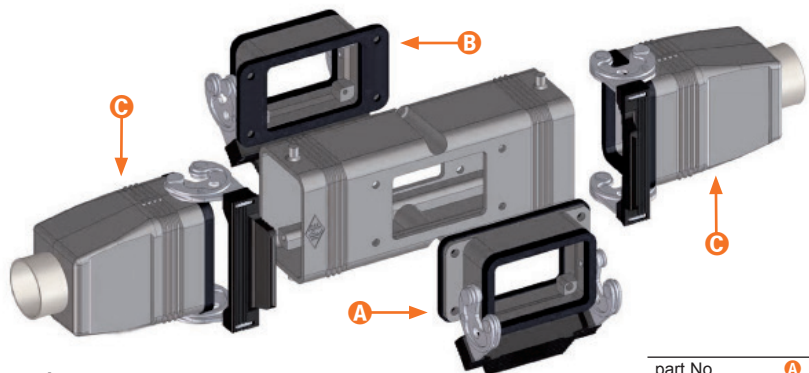

**Legend:**

- A** bulkhead mounting housings
- B** bulkhead mounting housings
- C** hoods with lever and gasket (LG)

part No.	A	B	C
<b>CYG 06H0610</b>	06	10	06
<b>CYG 06H1006</b>	10	06	06
<b>CYG 06H0606</b>	06	06	06
<b>CYG 06H1010</b>	10	10	06

**CAUS**® Type 4/4X/12



**screws**

**insert fastening screws**



**screws for second protective earth terminal**



description

part No.

part No.

to be fitted instead of the current insert fastening screws

**CRIC M3 \***

for CDA/CDC, CSAH inserts

for CD 15/25, CDD 38 inserts

for CD 40/64, CDD 24/42/72/108, CQE, CNE, CSS,

CX 8/24, CCE, CMSH, CME, CMCE, CSH, CDSH inserts

for CP, CX 12/2, CX 6/36, CX 6/12, CX 4/0, CX 4/2 inserts

**CR VATG**

**CR VDTG**

**CR VNTG**

**CR VPTG**

ILME will not be responsible for any different mounting applications. It is the responsibility of the installer to ensure the correct coupling and the continuity of the protective earth contact of the inserts.

\* The approved method of mounting inserts is by fixing the four screws in an ILME enclosure or housing.

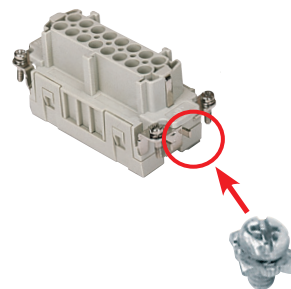
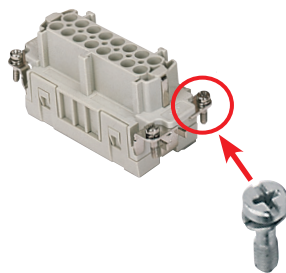

# for CT, CTS, CTSE inserts

## support for rail mounting DIN EN 60715

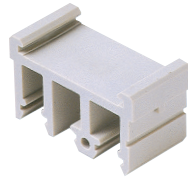

## CT/CTS/CTSE inserts coupling screws cable-clamping plates



description	part No.	part No.
supports for CT, CTS, CTSE inserts	<b>CT APE</b>	
bush for CT, CTS, CTSE inserts		<b>CRBF</b>
screw pin for CD, CNE, CCE, CSH inserts		<b>CRBM</b>
straight cable clamping plate		<b>CRAD</b>
angled cable clamping plate		<b>CRAS</b>

### Coupling screws for CT/CTSE inserts

The use of CRBF (female) and CRBM (male coupling screws is recommended to guarantee a stable and safe coupling between inserts (without enclosures) with terminal blocks and inserts without terminal blocks.

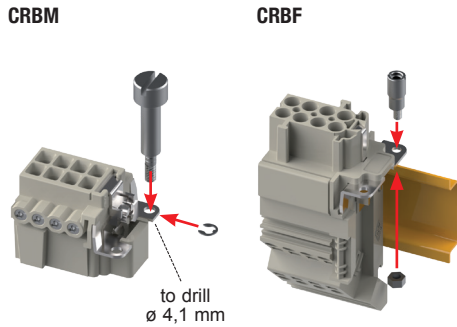

### Use of cable-clamping plates

In accordance with the recommendations of standard IEC 60352-2, the weight of the conductor groups or multipolar cables must not cause any stress on the contacts inside the inserts. It is therefore advisable to use cable-clamping plates in those inserts without enclosures.

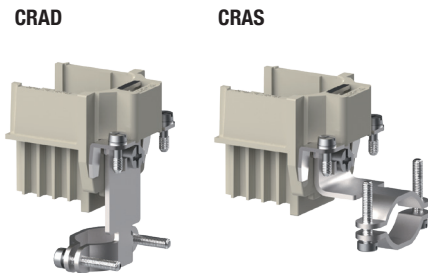

### CT APE

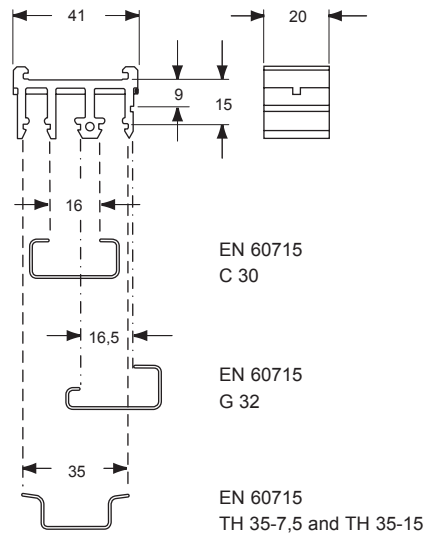

### CRBM

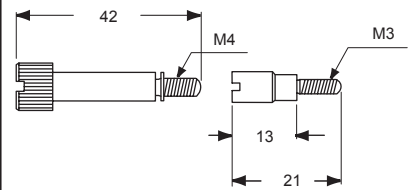

### CRBF

### CRAD

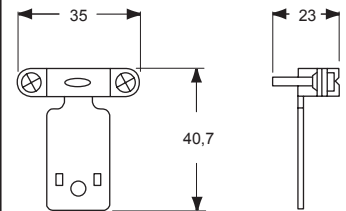

### CRAS

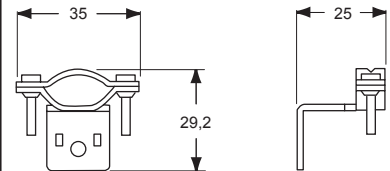

**Note:**  
for conductor groups or cable with  
Ø min = 12 mm and Ø max = 23 mm

# CIF PCB adapters

inserts		page:
CDD	24 poles + ⊕	76
CDD	42 poles + ⊕	78
CDD	72 poles + ⊕	79
CDD	108 poles + ⊕	81
CX	8/24 poles + ⊕	194
CX	6/36 poles + ⊕	198
CX 12 (MIXO)	12 poles	251

## interface for printed circuit

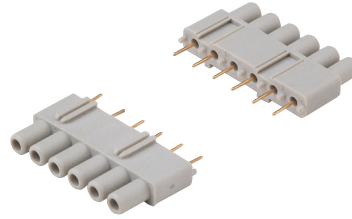

## 6A contacts for interface silver and gold plated



description	part No.	part No.	part No.
interface module with 6 female contacts (gold) for up to 2,4 mm thick PCB	<b>CIF 2.4</b>		
interface module with 6 female contacts (silver) for up to 2,4 mm thick PCB	<b>CIF 2.4 A</b>		
6A female contacts for female inserts with terminal Ø 1 mm		<b>CDFA 6A</b>	<b>CDFD 6A</b>
6A male contacts for male inserts with terminal Ø 1 mm		<b>CDMA 6A</b>	<b>CDMD 6A</b>

### CIF interface

The interface block is made according to the multipole connector used by assembling a suitable number of CIF modules (see table).

inserts serie	poles n°	modules "CIF" n°
CDD	24	4
CDD	42	7
CDD	72	12
CDD	108	18
CX	8/24	4
CX	6/36	6
CX (MIXO)	12	2

The block is then welded on the printed circuit on which the multipole connector (female or male) equipped with coupling contacts will then be inserted.

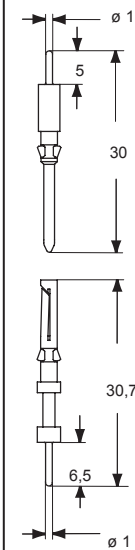
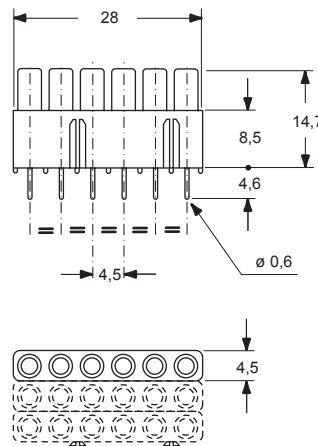

### CIF 2.4, CIF 2.4 A PCB ADAPTERS

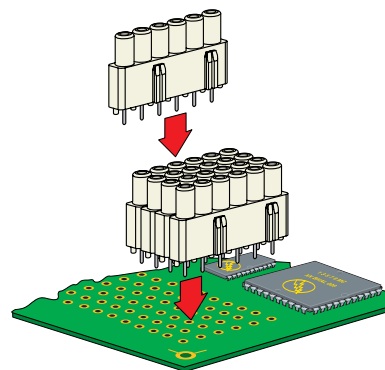
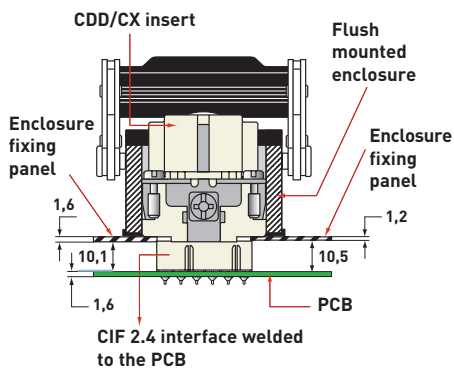
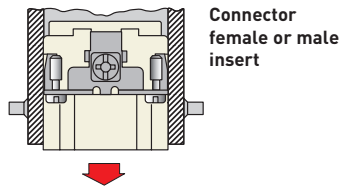

# CIF PCB adapters

inserts  
 CQ 8 poles + ⊕ page: 192

interface  
 for printed circuit

16A contacts for interface  
 silver plated

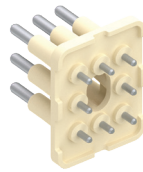

description	part No.	part No.
-------------	----------	----------

PCB adapter with contacts for up to 1,6 mm thick PCB **CIF Q08 1.6**

16A female contacts for female inserts

CCFFA silver plated

16A male contacts for male inserts

CCMFA

The block is soldered on the printed circuit on which the multipole connector (female or male) equipped with coupling contacts will then be inserted.

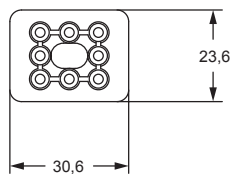
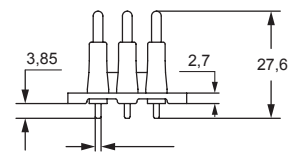

PCB-Layout

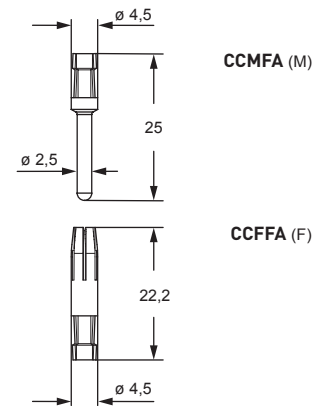
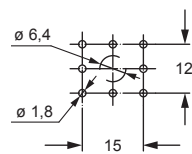

# CIF PCB adapters

inserts  
**CQ** 4 poles + 2 poles + ⊕ page: 191

interface  
 for printed circuit

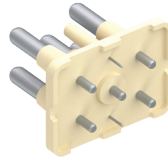

7,5A and 30A contacts for interface  
 silver plated

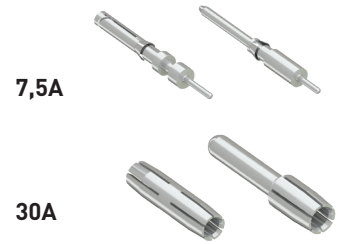

description	part No.	part No.
-------------	----------	----------

PCB adapter with contacts  
 for up to 2,4 mm thick PCB

**CIF Q4/2 2.4**

7,5A female contacts for female inserts  
 7,5A male contacts for male inserts

**CDFA 6A28**  
**CDMA 6A**

silver  
plated

30A female contacts for female inserts  
 30A male contacts for male inserts

**CXFFA**  
**CXMFA**

The block is soldered on the printed circuit on which the multipole connector (female or male) equipped with coupling contacts will then be inserted.

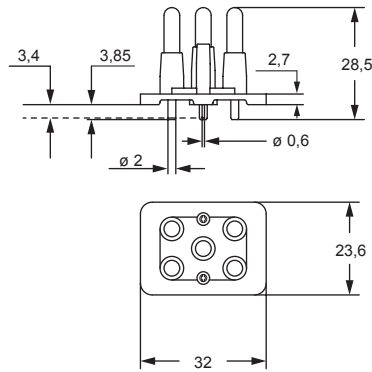

**PCB-Layout**

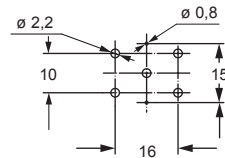

**CDMA 6A**

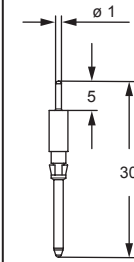

**CXMFA**

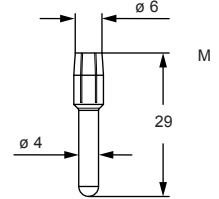

**CDFA 6A28**

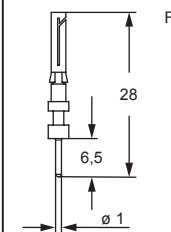

**CXFFA**

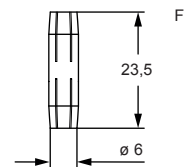

ACCESSORIES



# CC crimp contacts

inserts		page:
CDC	10, 16 poles + ⊕	104 - 105
CCE	6, 10, 16, 24, 32, 48 poles + ⊕	130 - 135
CMCE	3+2, 6+2, 10+2, 12+4, 20+4 (aux) poles + ⊕	137 - 145
CQE	10, 18, 32, 46, 64, 92 poles + ⊕	168 - 173
CQEE	40, 64 poles + ⊕	176 - 177
CQ	5 poles + ⊕	186
CX	8/24 poles + ⊕	194
CX	6/6 poles + ⊕	206
MIXO (16A)		245 - 259

## constantan (Cu Ni) crimp contacts



## iron (Fe) crimp contacts



description	part No.	part No.
16A, 0,3 mm <sup>2</sup> , AWG 22 female contacts	<b>CCFC 0.3</b>	<b>CCFF 0.3</b>
16A, 0,3 mm <sup>2</sup> , AWG 22 male contacts	<b>CCMC 0.3</b>	<b>CCMF 0.3</b>
16A, 0,5 mm <sup>2</sup> , AWG 20 female contacts	<b>CCFC 0.5</b>	<b>CCFF 0.5</b>
16A, 0,5 mm <sup>2</sup> , AWG 20 male contacts	<b>CCMC 0.5</b>	<b>CCMF 0.5</b>

**Note:**

A mixed combination of iron, constantan and silver and gold plated contacts can be fitted in the same insert.

- it is recommended to crimp the contacts with crimping tools homologated by ILME (please see the crimping tool section 16A contacts, CCF and CCM on pages 705 - 741)
- for type J (iron - constantan) thermocouples compliant with EN 60584-1
- contact resistance ≤ 1 Ohm

### CCF and CCM

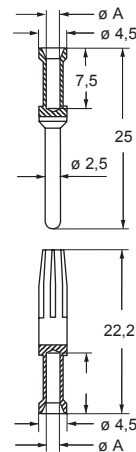

#### CCF and CCM contacts

conductor section mm <sup>2</sup>	conductor slot ø A (mm)	conductors stripping length mm
0,3	1,1	7,5
0,5	1,1	7,5

### CCF and CCM

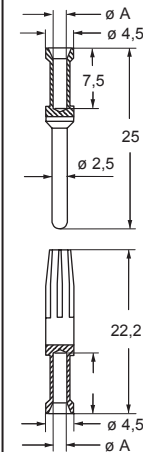

#### CCF and CCM contacts

conductor section mm <sup>2</sup>	conductor slot ø A (mm)	conductors stripping length mm
0,3	1,1	7,5
0,5	1,1	7,5

# CD crimp contacts 10A

inserts		page:
CD	(10A)	66 - 74
CDD	(10A)	76 - 83
CQ	(10A)	187 - 193
CX 8/24	(16A / 10A)	194
CX 6/36	(10A)	198
CX 12/2	(10A)	199
MIXO	(10A)	241 - 253

## 10A crimp contacts high thickness gold plated



## 10A crimp contacts basic gold plated



description	part No.	part No.
<b>10A female contacts</b>		
0,14-0,37 mm <sup>2</sup> AWG 26-22 identification No. 1	<b>CDF2D 0.3</b>	<b>CDFJD 0.3</b>
0,5 mm <sup>2</sup> AWG 20 identification No. 2	<b>CDF2D 0.5</b>	<b>CDFJD 0.5</b>
0,75 mm <sup>2</sup> AWG 18 identification No. ②	<b>CDF2D 0.7</b>	<b>CDFJD 0.7</b>
1,0 mm <sup>2</sup> AWG 18 identification No. 3	<b>CDF2D 1.0</b>	<b>CDFJD 1.0</b>
1,5 mm <sup>2</sup> AWG 16 identification No. 4	<b>CDF2D 1.5</b>	<b>CDFJD 1.5</b>
2,5 mm <sup>2</sup> AWG 14 identification No. 5	<b>CDF2D 2.5</b>	<b>CDFJD 2.5</b>
<b>10A male contacts</b>		
0,14-0,37 mm <sup>2</sup> AWG 26-22 identification No. 1	<b>CDM2D 0.3</b>	<b>CDMJD 0.3</b>
0,5 mm <sup>2</sup> AWG 20 identification No. 2	<b>CDM2D 0.5</b>	<b>CDMJD 0.5</b>
0,75 mm <sup>2</sup> AWG 18 identification No. ②	<b>CDM2D 0.7</b>	<b>CDMJD 0.7</b>
1,0 mm <sup>2</sup> AWG 18 identification No. 3	<b>CDM2D 1.0</b>	<b>CDMJD 1.0</b>
1,5 mm <sup>2</sup> AWG 16 identification No. 4	<b>CDM2D 1.5</b>	<b>CDMJD 1.5</b>
2,5 mm <sup>2</sup> AWG 14 identification No. 5	<b>CDM2D 2.5</b>	<b>CDMJD 2.5</b>

- The gold plated contacts provide:
- corrosion resistance (according to EN 60068)
  - mechanical life: ≥ 500 coupling cycles
  - in compliance with EN 61984:2009, IEC 60512, EN 60352-2: 1994
  - compliant to directive RoHS2
  - contact resistance: ≤ 3 mΩ
  - certifications: (UL for USA and Canada),

### CDF2D and CDM2D

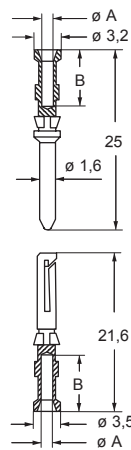

#### contacts CDF2D and CDM2D

conductor section mm <sup>2</sup>	conductor slot ø A (mm)	conductors stripping length B (mm)
0,14-0,37	0,9	8
0,5	1,1	8
0,75	1,3	8
1,0	1,45	8
1,5	1,8	8
2,5	2,2	6

### CDFJD and CDMJD

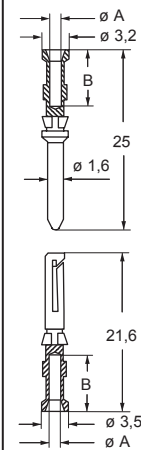

#### contacts CDFJD and CDMJD

conductor section mm <sup>2</sup>	conductor slot ø A (mm)	conductors stripping length B (mm)
0,14-0,37	0,9	8
0,5	1,1	8
0,75	1,3	8
1,0	1,45	8
1,5	1,8	8
2,5	2,2	6

# CC crimp contacts 16A

inserts		page:
CDC	(16A)	104 - 106
CCE	(16A)	130 - 135
CMCE	(16A)	137 - 145
CQE	(16A)	168 - 173
CQEE	(16A)	176 - 177
CX 8/24	(16A / 10A)	194
CX 6/6	(16A / 10A)	206
MIXO	(16A)	245 - 259

## 16A crimp contacts high thickness gold plated



## 16A crimp contacts basic gold plated



description	part No.	part No.
-------------	----------	----------

16A female contacts		
0,14-0,37 mm <sup>2</sup>	AWG 26-22	one groove
0,5 mm <sup>2</sup>	AWG 20	with no grooves
0,75 mm <sup>2</sup>	AWG 18	one groove (back side)
1 mm <sup>2</sup>	AWG 18	one groove
1,5 mm <sup>2</sup>	AWG 16	two grooves
2,5 mm <sup>2</sup>	AWG 14	three grooves
3 mm <sup>2</sup>	AWG 12	one wide groove
4 mm <sup>2</sup>	AWG 12	with no grooves

CCF2D 0.3
CCF2D 0.5
CCF2D 0.7
CCF2D 1.0
CCF2D 1.5
CCF2D 2.5
CCF2D 3.0
CCF2D 4.0

gold plated

CCFJD 0.3
CCFJD 0.5
CCFJD 0.7
CCFJD 1.0
CCFJD 1.5
CCFJD 2.5
CCFJD 3.0
CCFJD 4.0

gold plated

16A male contacts		
0,14-0,37 mm <sup>2</sup>	AWG 26-22	one groove
0,5 mm <sup>2</sup>	AWG 20	with no grooves
0,75 mm <sup>2</sup>	AWG 18	one groove (back side)
1 mm <sup>2</sup>	AWG 18	one groove
1,5 mm <sup>2</sup>	AWG 16	two grooves
2,5 mm <sup>2</sup>	AWG 14	three grooves
3 mm <sup>2</sup>	AWG 12	one wide groove
4 mm <sup>2</sup>	AWG 12	with no grooves

CCM2D 0.3
CCM2D 0.5
CCM2D 0.7
CCM2D 1.0
CCM2D 1.5
CCM2D 2.5
CCM2D 3.0
CCM2D 4.0

CCMJJD 0.3
CCMJJD 0.5
CCMJJD 0.7
CCMJJD 1.0
CCMJJD 1.5
CCMJJD 2.5
CCMJJD 3.0
CCMJJD 4.0

The gold plated contacts provide:

- corrosion resistance (according to EN 60068)
- mechanical life: ≥ 500 coupling cycles
- in compliance with EN 61984:2009, IEC 60512, EN 60352-2: 1994
- compliant to directive RoHS2
- contact resistance: ≤ 1 mΩ
- certifications: us (UL for USA and Canada),

### CCF2D and CCM2D

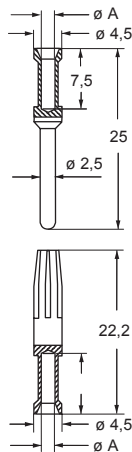

#### contacts CCF2D and CCM2D

conductor section	conductor slot	conductors stripping length
mm <sup>2</sup>	ø A (mm)	mm
0,14-0,37	0,9	7,5
0,5	1,1	7,5
0,75	1,3	7,5
1,0	1,45	7,5
1,5	1,8	7,5
2,5	2,2	7,5
3,0	2,55	7,5
4,0	2,85	7,5

### CCFJD and CCMJJD

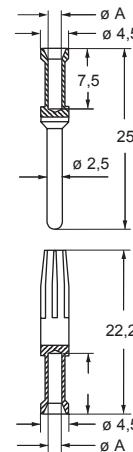

#### contacts CCFJD and CCMJJD

conductor section	conductor slot	conductors stripping length
mm <sup>2</sup>	ø A (mm)	mm
0,14-0,37	0,9	7,5
0,5	1,1	7,5
0,75	1,3	7,5
1,0	1,45	7,5
1,5	1,8	7,5
2,5	2,2	7,5
3,0	2,55	7,5
4,0	2,85	7,5

## POF contacts series

### CLF DD and CLM DD

Fibre optic cables provide data transmission not subject to electromagnetic interference, contrary to copper-based (electric) data transmission.

The new fibre optic contacts **CL series (CLF DD and CLM DD)** can be used in combination with POF (polymer optical fibre) Ø 1,0 mm (core) / 2,2 mm (sheath) in ILME range of heavy duty multipole connectors, offering the following features:

- inherent immunity to EMI (electromagnetic interference);
- perfect electrical insulation;
- lightweight;
- high transmission capacity and high bandwidth;
- high data security;
- IP66/IP67 recommended to minimize impairing effect of dust contamination;
- male and female contacts CL series for POF Ø 1,0 mm (core) / 2,2 mm (sheath), with same geometry of crimp contacts CD series for conventional copper conductors;
- usable in connector inserts with contact cavities geometry of CDD series, including some modules of MIXO series and some inserts of CQ series, according to **Table 1**.  
Not for use in CD inserts series <sup>1)</sup>;

**Table 1.**

<b>CDD series</b>	CDDF/M 24
NOTE – Not suitable for CDDF/M 38 /38 N	CDDF/M 42
	CDDF/M 72, CDDF/M 72 N
	CDDF/M 108, CDDF/M 108 N
<b>CQ series</b>	CQF/M 07
	CQF/M 12
	CQF/M 17
<b>MIXO series</b> modular connectors	CX 12 DF/DM (p. 40 this ctlg.)
	CX 17 DF/DM
<b>CX series</b> combined connectors – aux poles number of cavities highlighted in <b>bold</b>	CXF/M 8/ <b>24</b>
	CXF/M 6/ <b>36</b>
	CXF/M 12/ <b>2</b>

<sup>1)</sup> For CD inserts series a similar solution for use of POF Ø 1 mm may be developed upon request: please contact our Sales Department or our local Subsidiaries/Distributors.



- use of **alignment/coding pins on connectors/connector modules is mandatory** for fibre optic applications, in order to avoid damages to contacts and in order to minimize the natural attenuation of light signal which is mainly due to inaccuracy of the mating surfaces of the POF (polishing and perfect cleanliness of the two mating fibres) and to axial misalignment;
- POF to be stripped, crimped, cut and polished according to instructions on pages besides.
- for size "77.62" 2-insert combinations use JCHI 32 L/LP (page 120 catalogue XDG JEI 415) or a special version with stainless steel rigid lever available upon request.
- for the installation of fibre optic, **it is recommended to use only bulkhead mounting housings and corresponding hoods with vertical cable outlet.**



Watch  
our  
online  
tutorial

# CLF DD / CLM DD

inserts:		page:
CDD	(10A)	76 - 83
CQF/M 07	(10A)	187
CQF/M 12	(10A)	189
CQF/M 17	(10A)	193
MIXO CX 12 DF/DM	(10A)	251
MIXO CX 17 DF/DM	(10A)	252
CXF/M 8/24	(10A)	194
CXF/M 6/36	(10A)	198
CXF/M 12/2	(10A)	199

## POF crimp contacts



description	part No.
-------------	----------

female contacts for POF*	<b>CLF DD</b>
male contacts for POF*	<b>CLM DD</b>

**POF = Polymer Optical Fibre**

- ambient temperature limit: -40 °C ... +85 °C
- max external diameter: 2,2 mm (POF)
- polymer fibre diameter: 1 mm (POF)
- to crimp contacts CLF DD and CLM DD please use tool CLPZ R
- we recommend use of guide pins CRM/CRF (refer to page 685)

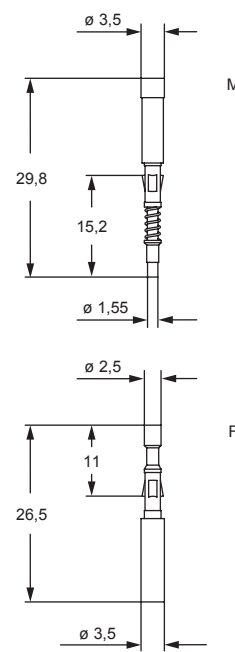

conductor stripping

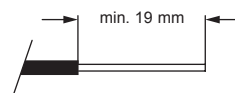

male contacts

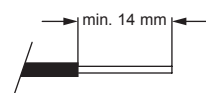

female contacts

# CR anchorages

inserts

MIXO series

from page 232

shield earthing anchorage for shielded cables  
(for MIXO series)  
clamps for cables w/shield Ø 5 mm and  
Ø 10 mm



anchorages for several PE connection  
cables (for MIXO series)

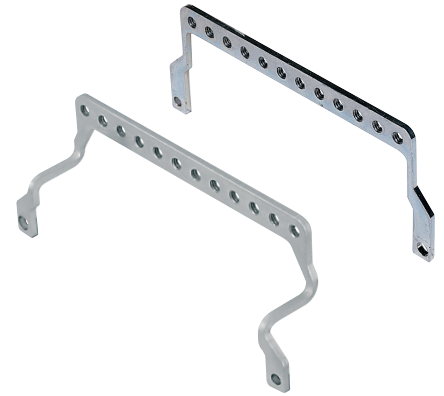

description

part No.

part No.

in zinc plated steel, to be mounted on MIXO frames  
in bulkhead mounting housings, COB series enclosures  
and high construction hoods with top entry  
enclosures "44.27" and MIXO frames for 2 modular units  
enclosures "57.27" and MIXO frames for 3 modular units  
enclosures "77.27", "77.62" and MIXO frames for 4 modular units  
enclosures "104.27", "104.62" and MIXO frames for 6 modular units

**CR 06 ST**  
**CR 10 ST**  
**CR 16 ST**  
**CR 24 ST**

to be mounted on CR..ST earthing terminals  
clamp for shielding cables Ø 5 mm  
clamp for shielding cables Ø 10 mm

**CR 05 CA**  
**CR 10 CA**

in zinc plated steel, to be mounted on MIXO frames  
in bulkhead mounting housings, COB series enclosures  
and high construction hoods with top entry  
enclosures "44.27" and MIXO frames for 2 modular units  
enclosures "57.27" and MIXO frames for 3 modular units  
enclosures "77.27", "77.62" and MIXO frames for 4 modular units  
enclosures "104.27", "104.62" and MIXO frames for 6 modular units  
enclosures "104.27", "104.62" and MIXO frames for 6 modular units

**CR 06 AT**  
**CR 10 AT**  
**CR 16 AT**  
**CR 24 AT**  
**CR 24 ATD**

Anchorages CR .. ST are designed for installation on  
the frames of the MIXO modular connectors, for earth  
connecting the screening braid of shielded cables.

Anchorages CR .. AT / ATD are designed for installation  
on the frames of the MIXO modular connectors for earth  
connecting several cables.

**CR...ST**

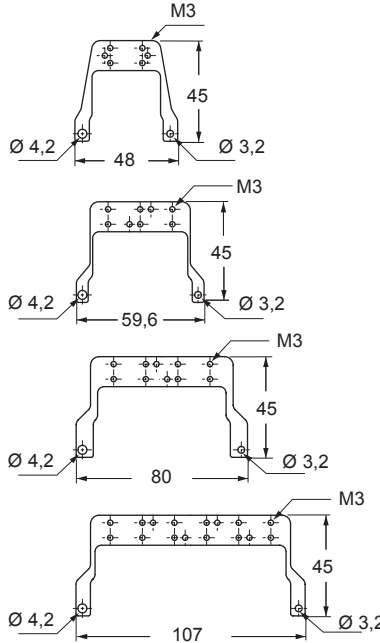

**CR...AT**

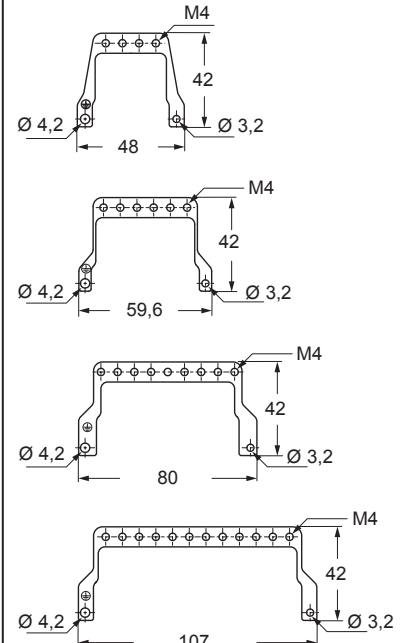

**CR...CA**

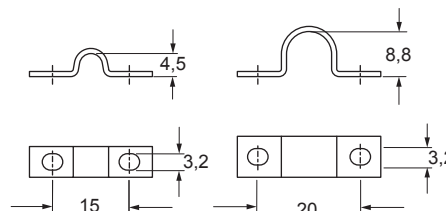

**CR 24 ATD**

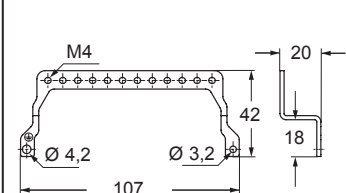

# CR anchorages

inserts		page:
CD	40, 64 poles + ⊕	<b>70 and 72</b>
CDD	24, 42, 72, 108 poles + ⊕	<b>76 - 81</b>
CDS	9, 18, 27, 42 poles + ⊕	-
CDSH	9, 18, 27, 42 poles + ⊕	<b>86 - 89</b>
CDSH NC	6 poles + ⊕	<b>95</b>
CNE	6, 10, 16, 24 poles + ⊕	<b>110 - 113</b>
CSE	6, 10, 16, 24 poles + ⊕	-
CSH	6, 10, 16, 24 poles + ⊕	<b>110 - 113</b>
CSH S	6, 10, 16, 24 poles + ⊕	<b>122 - 125</b>
CCE	6, 10, 16, 24 poles + ⊕	<b>130 - 133</b>
CMSH	3+2, 6+2, 10+2 (aux) poles + ⊕	<b>136 - 140</b>
CSS	6, 10, 16, 24 poles + ⊕	<b>148 - 151</b>
CQE	10, 18, 32, 46 poles + ⊕	<b>168 - 171</b>
CQEE	40, 64 poles + ⊕	<b>176 - 177</b>
CP	6 poles + ⊕	<b>178</b>
CX	8/24, 6/36, 12/2 poles + ⊕	<b>194 - 199</b>

## ground terminals for shielded cables and for several earth connections



## clamps for cables Ø 5 mm and Ø 10 mm



description	part No.	part No.
-------------	----------	----------

in zinc plated iron, to be fitted on connectors in bulkhead housings, COB series enclosures and high construction hoods with top entry  
 "44.27" enclosures and inserts  
 "57.27" enclosures and inserts  
 "77.27", "77.62" enclosures and inserts  
 "104.27", "104.62" enclosures and inserts  
 CSS "104.27" enclosures and inserts \*

**CR 06 SC**  
**CR 10 SC**  
**CR 16 SC**  
**CR 24 SC**  
**CR 24 SCA**

to be fitted on CR..SC anchors  
 in bulkhead mounting housings and high construction hoods  
 U-bolt for Ø 5 mm cable screening  
 U bolt for Ø 10 mm cable screening

**CR 05 CA**  
**CR 10 CA**

\* Can be used only in bulkhead housings.

The CR... SC anchors are fitted on connectors for connecting to earth multiple cables and screened cables braids.

### CR...SC

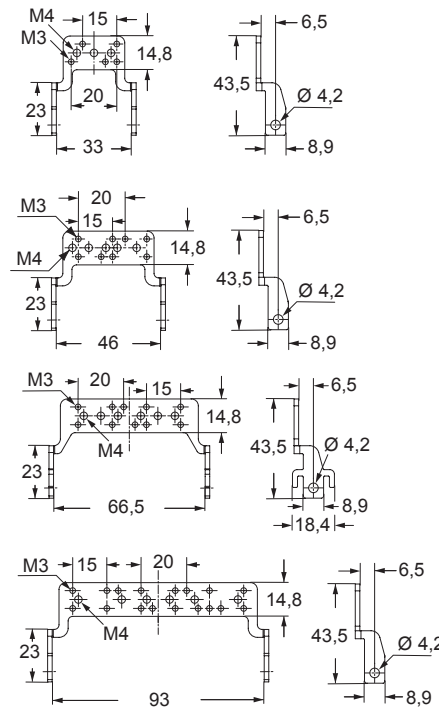

### CR...SCA

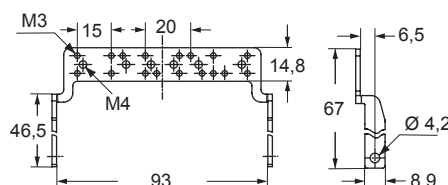

### CR...CA

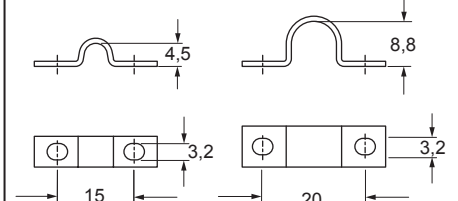



# CR anchorages

The CR..FS series anchorages are employed for use of connector inserts (normal or MIXO modular) without enclosures and enable anchoring cables with clamps to prevent transmitting friction forces to contacts. CR..SS anchorages (with grip to facilitate connector disconnection) are used for earth connecting of several conductors and/or of the screen of shielded cables.

## cable anchorages / shield earthing strain



## supports, screws and clamps for grip panels of cables outside enclosure

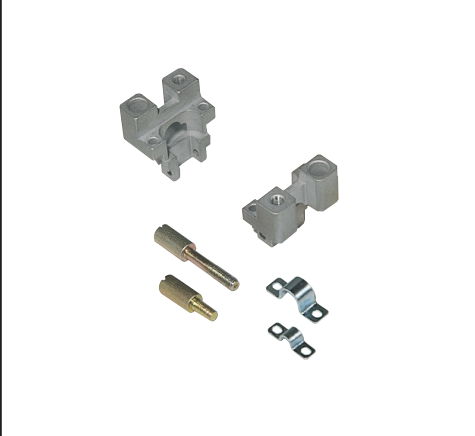

description	part No.	part No.
in zinc plated steel, to be mounted on: inserts size "44.27" * and MIXO frames for 2 modular units inserts size "57.27" * and MIXO frames for 3 modular units inserts size "77.27" * and MIXO frames for 4 modular units inserts size "104.27" * and MIXO frames for 6 modular units	<b>CR 06 FS</b> <b>CR 10 FS</b> <b>CR 16 FS</b> <b>CR 24 FS</b>	
for shielded cables with grip handle, to be mounted on: inserts size "77.27" * and MIXO frames for 4 modular units inserts size "104.27" * and MIXO frames for 6 modular units	<b>CR 16 SS</b> <b>CR 24 SS</b>	
supports in die-cast zinc N° 2 pieces equipped with fixing screws and washers for earth connection		<b>CR SP</b>
short screws in zinc iron, N° 2 pieces long screws in zinc iron, N° 2 pieces		<b>CR 26 V</b> <b>CR 42 V</b>
to be mounted on CR..SS anchorage clamp for shielding cables Ø 5 mm clamp for shielding cables Ø 10 mm		<b>CR 05 CA</b> <b>CR 10 CA</b>

\* Except CT, CTS and CTSE

In the fixed part, a pair of CR SP supports is fitted on the connector, using its securing screws. A CR..FS or CR..SS anchorage is fitted on the supports, using the supplied fixing screws and washers. All parts are secured on the rear panel with the pair of CR 26 V viton screws.

In the mobile part too, a pair of CR SP supports are fitted on the connector and a CR..FS or CR..SS anchorage is secured on it. The pair of CR 42 V screws fasten the mobile part to the fixed part.

**Note:**  
By unscrewing the CR 26 V panel screws, the whole assembly (mobile part + fixed part) can be removed from the panel for inspection.

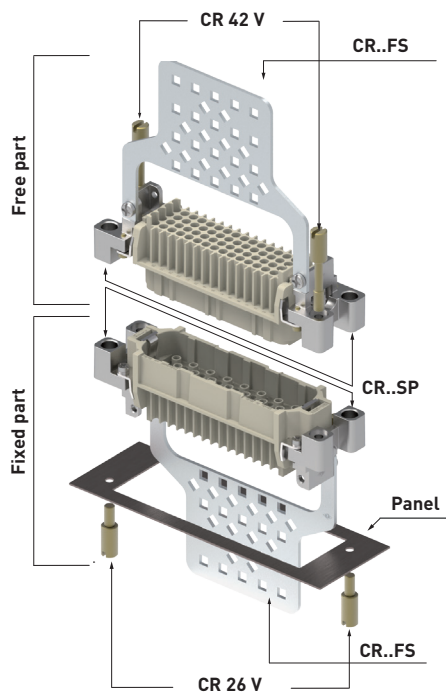

### CR...FS

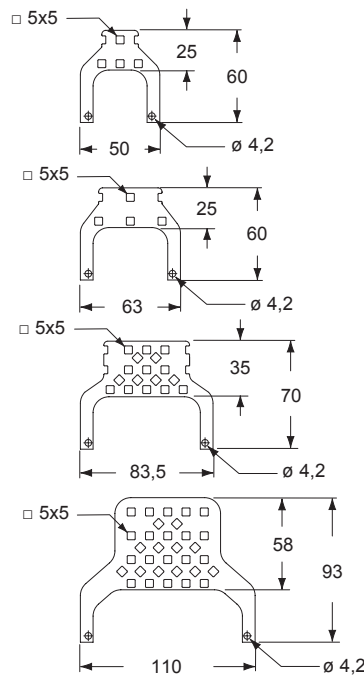

### CR 16 SS (CR 24 SS)

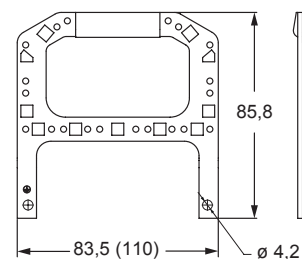

### CR SP

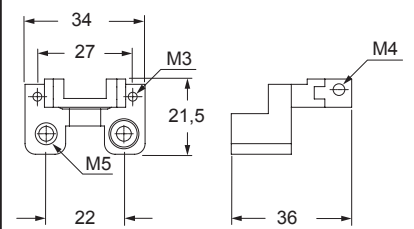

### panel cut-out

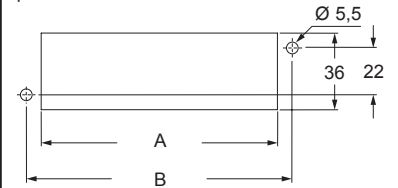

poles	06	10	16	24
A	52	65	85,5	112
B	65	78	98,5	125

### CR 26 V

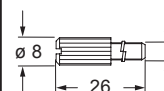

### CR 42 V

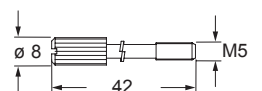

### CR...CA

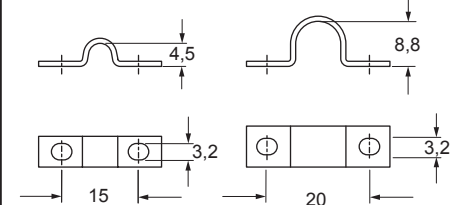

# CR anchorages

anchorage for cables outside enclosure, equipped with fixing screws and washers

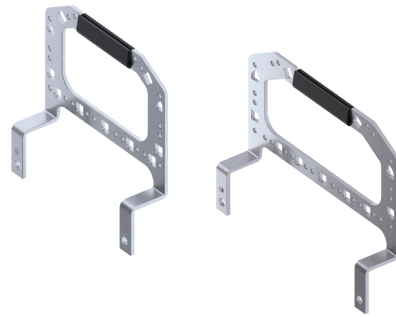

support, screws and clamps for grip panels of cables outside enclosure

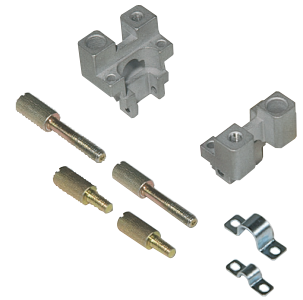

description	part No.	part No.
-------------	----------	----------

for cables, to be mounted on:  
 inserts size "77.27"\* with CR SP support  
 and MIXO frames for 4 inserts without support  
 inserts size "104.27"\* with CR SP support  
 and MIXO frames for 6 inserts without support

**CR 16 SSD**

**CR 24 SSD**

support in die-cast zinc, 2 pcs. equipped with fixing screws and rings for earth connecting

**CR SP**

short screws in zinc plated steel, 2 pcs.  
 long screws in zinc plated steel, 2 pcs.

**CR 26 V**

**CR 42 V**

to be mounted on CR..SS anchorage  
 clamp for (shielded) cables  $\varnothing$  5 mm  
 clamp for (shielded) cables  $\varnothing$  10 mm

**CR 05 CA**

**CR 10 CA**

\* Except CT, CTS and CTSE

In the fixed part, a pair of **CR SP** supports is fitted on the connector insert, using the insert's fixing screws.

A **CR..SSD** anchorage is then fitted on the **CR SP** supports, using the supplied fixing screws and washers.

All parts are secured on the rear panel with a pair of **CR 26 V** special short screws.

Also in the free part, a pair of **CR SP** supports is fitted on the connector insert and a **CR..SSD** anchorage is similarly secured on it. A pair of **CR 42 V** long screws fasten the free part to the fixed part.

**NOTE:** By unscrewing the **CR 26 V** special short screws, the whole assembly (free part + fixed part) can be removed from the panel for inspection.

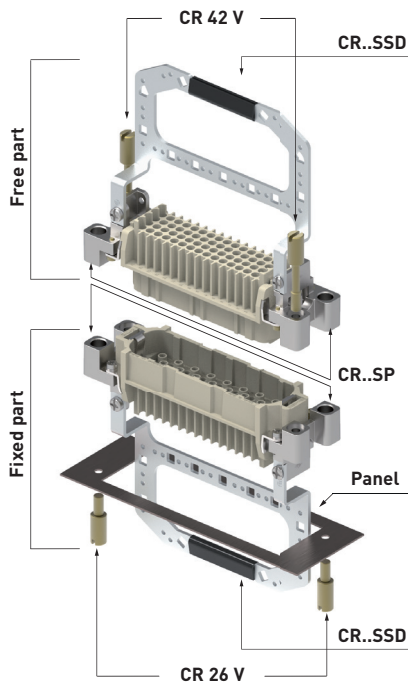

### CR 16 SSD

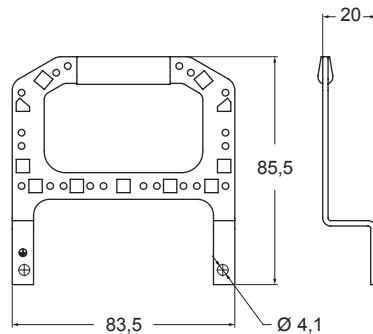

### CR 24 SSD

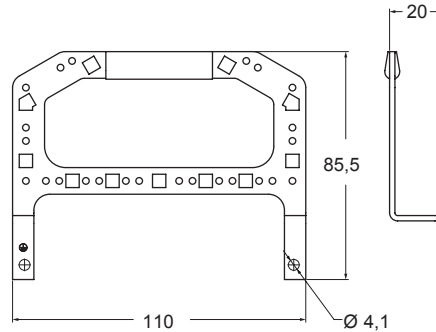

### CR SP

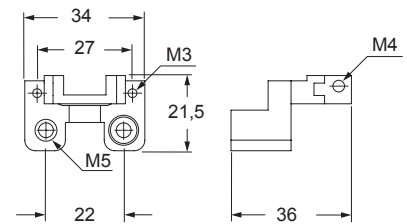

panel cut-out

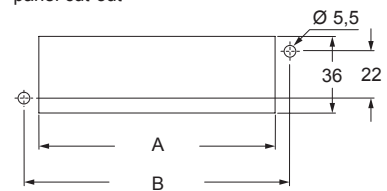

poles	06	10	16	24
A	52	65	85,5	112
B	65	78	98,5	125

### CR 26 V

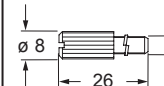

### CR 42 V

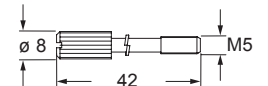

### CR..CA

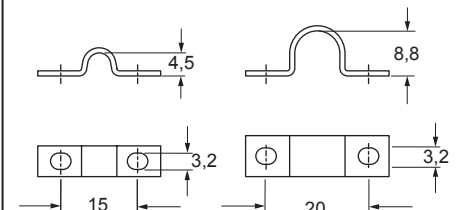

# CR...DF self-centring floating frame

**Caution:**

As the frames are floating, the **PE earthing connection of the metal surfaces on which they are mounted (mounting bases) must be performed separately** and cannot be done by connecting the PE earthing contact to the corresponding connector inserts.

**Note:**

The supply includes 1 frame and 4 shoulder screws with cylindrical head and notch to fix the frame in place.

For use with MIXO inserts CX 04 X, please contact ILME S.p.A.

**self-centering floating frame**

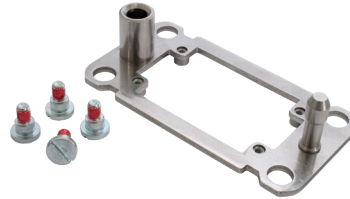

description

part No.

in stainless steel, to be mounted on:  
 inserts size "44.27" \* and MIXO frames for 2 modular units  
 inserts size "57.27" \* and MIXO frames for 3 modular units  
 inserts size "77.27" \* and MIXO frames for 4 modular units  
 inserts size "104.27" \* and MIXO frames for 6 modular units

- CR 06 DF**
- CR 10 DF**
- CR 16 DF**
- CR 24 DF**

\* Except CT, CTS and CTSE

**Technical specifications**

- materials
  - floating frame, inserts: stainless steel
  - fixing screws: zinc-plated steel
- mechanical endurance:  $\geq 500$  cycles
- compensation range:
  - x axis:  $\pm 1,5$  mm
  - y axis:  $\pm 1,5$  mm

**Characteristics**

- Suitable, depending on size, for all MIXO connector inserts and frames, except series CT, CTS and CTSE.
- Designed to be used in the transportation, printing and power electronic industries (for example boxes for rack cabinets) and in all industrial applications that require, during assembly or maintenance, the connection of connectors without possibility of controlling the alignment.
- Enables the **self-centering coupling of two corresponding** connectors without the use of enclosures; they freely move on their base plate ( $\pm 1,5$  mm on both axes) ensuring the **alignment of the coupling**.

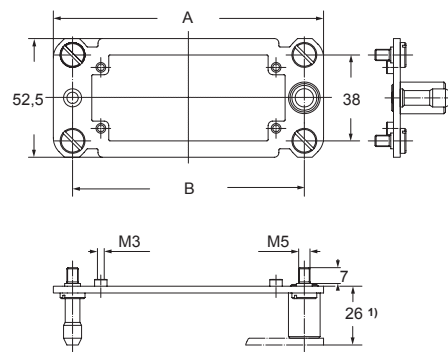

1) distance for electric and fibre optic contacts: max 27 mm  
 distance for pneumatic contacts: max 26,5 mm

panel cut-out

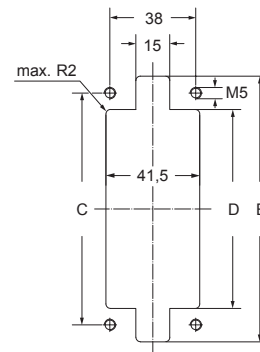

part No.	A	B	C	D	E
<b>CR 06 DF</b>	86	69	69	54,5	84
<b>CR 10 DF</b>	99	82	82	67,5	97
<b>CR 16 DF</b>	119,5	102,5	102,5	88	117,5
<b>CR 24 DF</b>	146	129	129	114,5	144

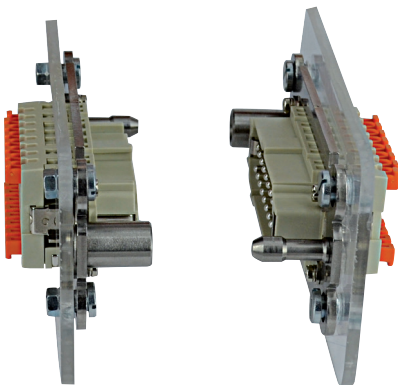

ACCESSORIES

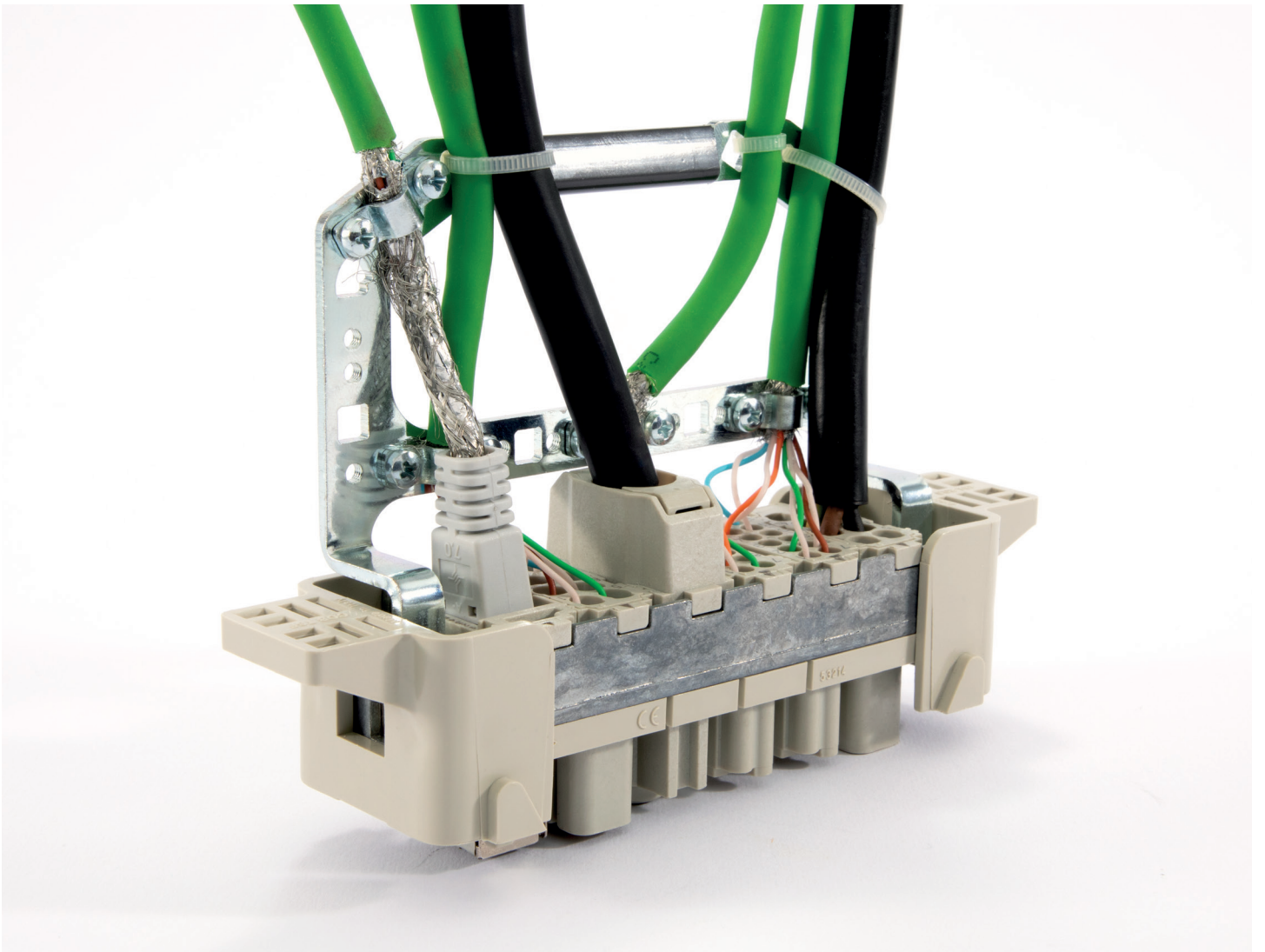

# CR coding pins

## single coding pins for 6 codings



## coding options using single code pins

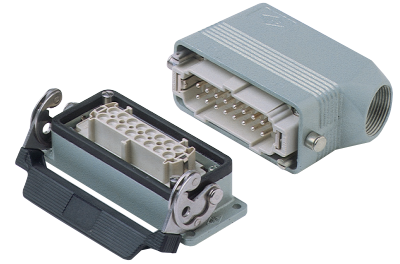

description	part No.	part No
single code pin (not for MIXO inserts)	stainless steel <b>CR 20</b>	zinc plated iron <b>CR 20 D</b>
single code pin (for MIXO inserts only)	stainless steel <b>CR 20 CX</b>	zinc plated iron <b>CR 20 CX D</b>

### CR 20/CR 20 D and CR 20 CX/CR 20 CX D coding pins

Each series of connector inserts is made in such a way as to make incorrect coupling between inserts of different series impossible. When a number of identical connectors with different functions are mounted closely together these must be selected in such a way as to prevent the coupling of a mobile part on a non-corresponding fixed part and consequent damage and breakdown.

Code pins are supplied to apply in place of the normal insert fastening screws (see example below). In this way the coupling of identical connectors is assured. The combination of code pins makes it possible to obtain a high number of selective couplings.

### CR 20 / CR 20 D

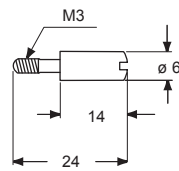

### CR 20 CX / CR 20 CX D

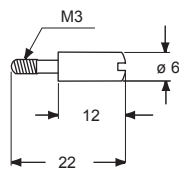

### Application with single insert

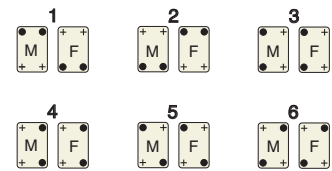

### Application with double inserts

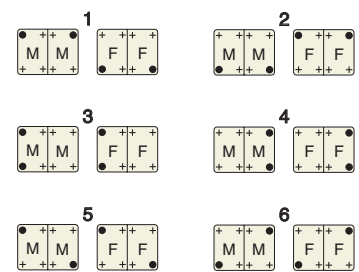

- code pin  
(CR 20/CR 20 D and CR 20 CX/CR 20 CX D)
- + normal fixing screw
- M = male insert
- F = female insert

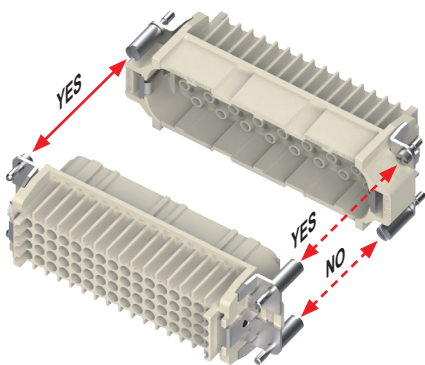



# CR coding pins

double coding and guide pins for 16 codings



coding options is made by using double coding and guide pins



description	part No.	part No
double coding pins (excluding MIXO inserts) male pin	stainless steel <b>CRM</b>	zinc plated iron <b>CRM D</b>
female pin	<b>CRF</b>	<b>CRF D</b>
double code pins (for MIXO inserts only) male pin	stainless steel <b>CRM CX</b>	zinc plated iron <b>CRM CX D</b>
female pin	<b>CRF CX</b>	<b>CRF CX D</b>

**Coding pins**

- CRM/CRM D and CRF/CRF D
- CRM CX/CRM CX D and CRF CX/CRF CX D

Each series of connector inserts is made in such a way as to make incorrect coupling between inserts of different series impossible.

When a number of identical connectors with different functions are mounted closely together these must be selected in such a way as to prevent the coupling of a mobile part on a non-corresponding fixed part and consequent damage and breakdown.

Code pins are supplied to apply in place of the normal insert fastening screws (see example below). In this way the coupling of identical connectors is assured.

The combination of code pins makes it possible to obtain a high number of selective couplings.

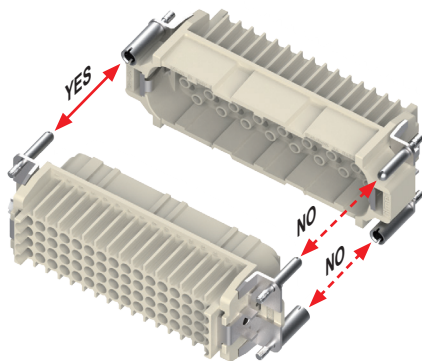

Even when coding is not required, it is recommended to use CRM and CRF pins with CD and CDD inserts to reduce movements when fitting and removing the connectors and to avoid contact damages.

Within this scope, the standard DIN 43 652 requires a maximum angular longitudinal fluctuation of ± 5°.

**CRM / CRM D**

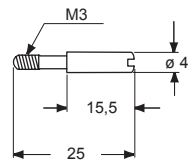

**CRF / CRF D**

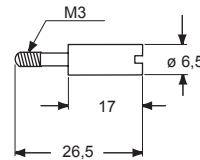

**CRM CX / CRM CX D**

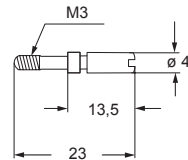

**CRF CX / CRF CX D**

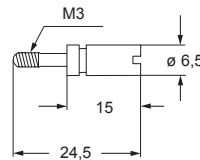

**Application with single insert**

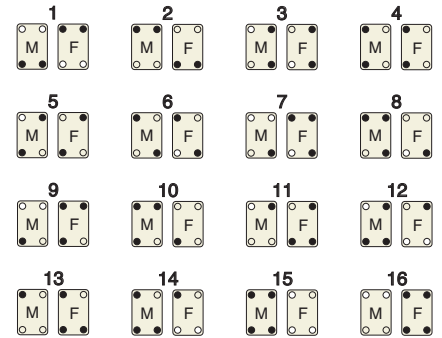

**Application with double inserts**

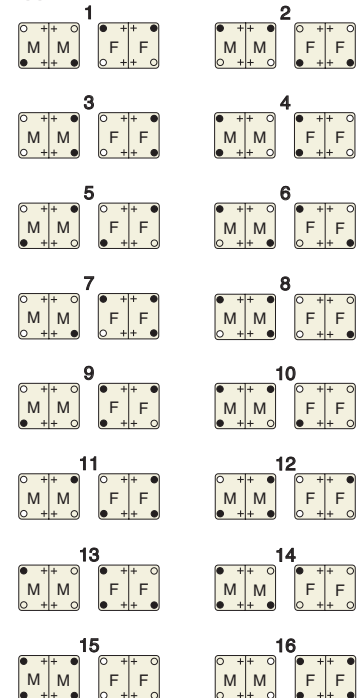

- female code pin (CRF/CRF D and CRF CX/CRF CX D)
- male code pin (CRM/CRM D and CRM CX/CRM CX D)
- + normal fixing screw
- M = male insert
- F = female insert

# CR coding pins

## coding and guide pins, for 72 codings



description	part No.	part No
double coding pins (excluding MIXO inserts) male pin female pin single code pin	stainless steel <b>CRM</b> <b>CRF</b> <b>CR 72</b>	zinc plated iron <b>CRM D</b> <b>CRF D</b> <b>CR 72 D</b>
double coding pins (for MIXO inserts only) male pin female pin single code pin	stainless steel <b>CRM CX</b> <b>CRF CX</b> <b>CR 72 CX</b>	zinc plated iron <b>CRM CX D</b> <b>CRF CX D</b> <b>CR 72 CX D</b>

### Coding pins

- CRM/CRM D, CRF/CRF D and CR 72/CR 72 D
- CRM CX/CRM CX D, CRF CX/CRF CX D and CR 72 CX/CR 72 CX D

Each series of connector inserts is made in such a way as to make incorrect coupling between inserts of different series impossible. When a number of identical connectors with different functions are mounted closely together these must be selected in such a way as to prevent the coupling of a mobile part on a non-corresponding fixed part and consequent damage and breakdown.

Code pins are supplied to apply in place of the normal insert fastening screws. In this way the coupling of identical connectors is assured. The combination of code pins makes it possible to obtain a high number of selective couplings.

### CRM / CRM D

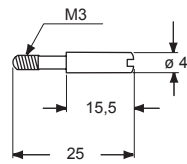

### CRF / CRF D

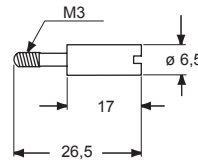

### CR 72 / CR 72 D

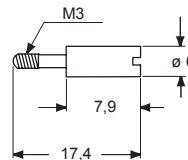

### CRM CX / CRM CX D

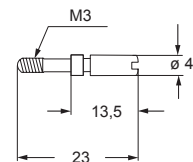

### CRF CX / CRF CX D

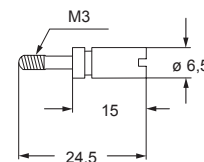

### CR 72 CX / CR 72 CX D

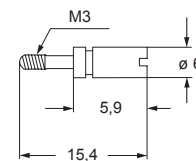



### Coding options using the three coding pins

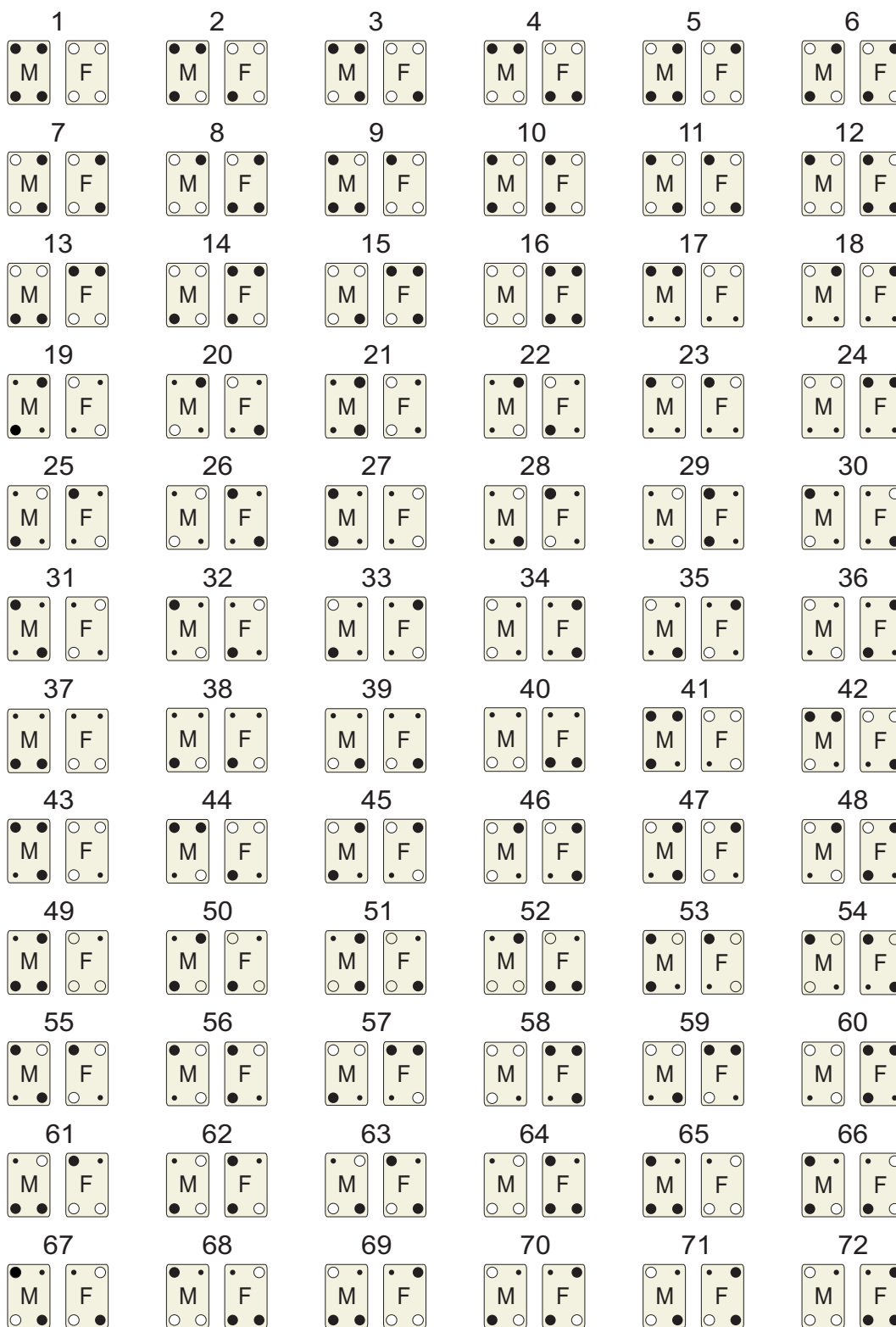

- female code pin (CRF/CRF D and CRF CX/CRF CX D)
- male code pin (CRM/CRM D and CRM CX/CRM CX D)
- single code pin (CR 72/CR 72 D and CR 72 CX/CR 72 CX D)
- M = male insert
- F = female insert

# CR coding pins

coding pin  
for CK / CKS 03 inserts



coding pins  
for CK / CKS 04 inserts



description	part No.	part No.	part No.
coding pin for CK/CKS 03 inserts	<b>CR K03</b>	<b>red CR K04R</b>	<b>yellow CR K04G</b>
coding pins for CK/CKS 04 inserts			

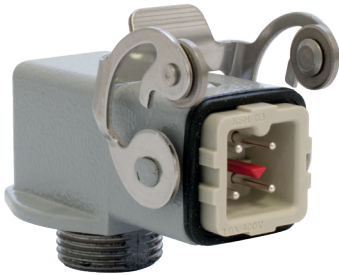

**CR K03**

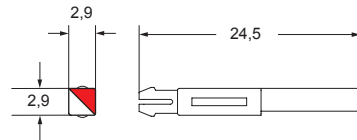

**CR K04R**

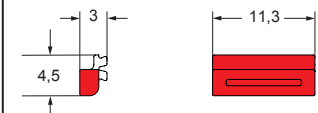

**CR K04G**

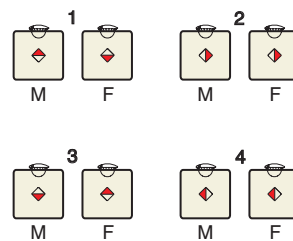
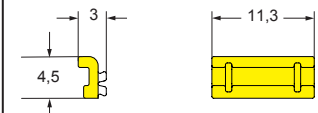

**M = male insert  
F = female insert**

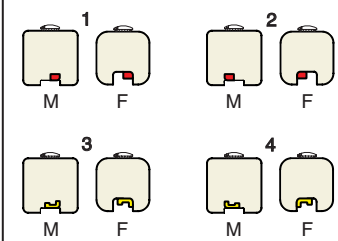

**M = male insert  
F = female insert**

ACCESSORIES

# CR coding pins

## coding pins for crimp inserts



## coding pin for CQ 12 inserts

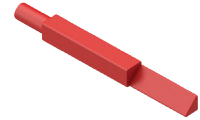

description	part No.	part No.
-------------	----------	----------

coding pins for CDC, CQ, CQE, CCE, CMCE, MIXO (16A) inserts  
pin to be inserted into one contact cavity of the female insert instead of the crimp contact, the corresponding contact cavity of the male insert must be left empty

**CR CPQ**

coding pins for CD and CDD inserts  
plastic pin, to be inserted into one contact cavity of the female insert instead of a crimp contact, the corresponding contact cavity of the male insert must be left empty

**CR CP**

coding pins for CQ 12 inserts

**CR Q12**

### Coding pins

Each series of connector inserts is made in such a way as to make incorrect coupling between inserts of different series impossible.

When a number of identical connectors with different functions are mounted closely together these must be selected in such a way as to prevent the coupling of a mobile part on a non-corresponding fixed part and consequent damage and breakdown.

Within this scope, special coding pins have been manufactured in order to restrict or avoid mating identical multiple connectors.

By combining multiple coding pins, a high number of selected matings can be produced.

### CR CPQ

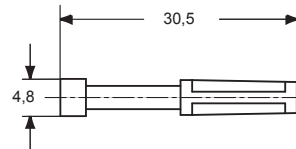

### CR CP

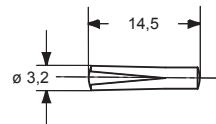

### CR Q12

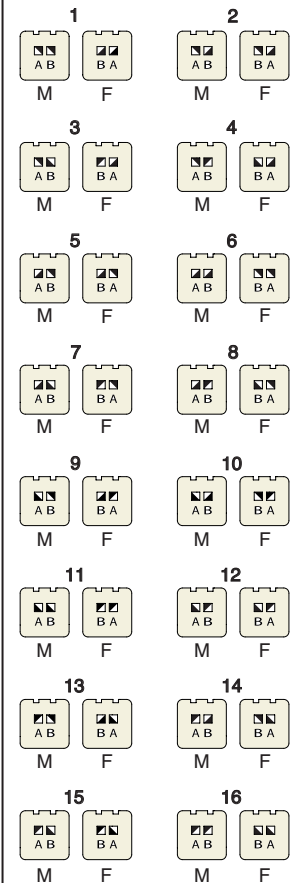
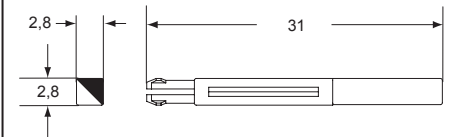

(A B) CQ 12 coding pin      M = male insert  
 F = female insert

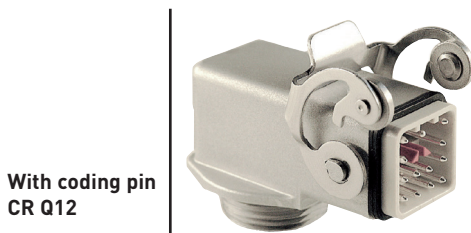

With coding pin CR Q12

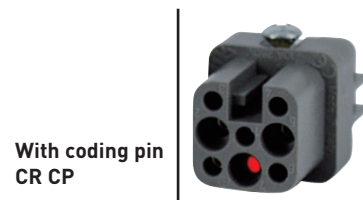

With coding pin CR CP

# CR coding pins

coding pin  
for CQF 07 insert



coding pin  
for CQM 07 insert



description	part No.	part No.
-------------	----------	----------

coding pins for CQF 07 inserts

**CR QF07**

coding pins for CQM 07 inserts

**CR QM07**

### Coding pins

Each series of connector inserts is made in such a way as to make incorrect coupling between inserts of different series impossible.

When a number of identical connectors with different functions are mounted closely together these must be selected in such a way as to prevent the coupling of a free part on a non-corresponding fixed part and possible consequent damage and breakdown.

Within this scope, special coding pins have been made available in order to restrict or avoid incorrect mating between multiple identical connectors.

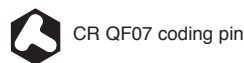
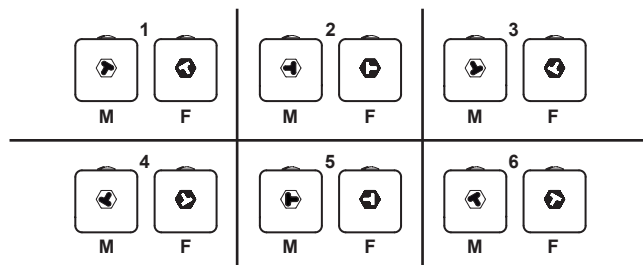
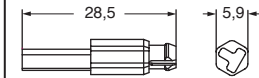
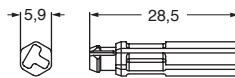

M = male insert  
F = female insert

# CR coding pins



description	part No.
-------------	----------

coding pins (optional) for CQ4 Q2 inserts	<b>CR Q02</b>
---	---------------

## CR Q02 CODING OPTIONS

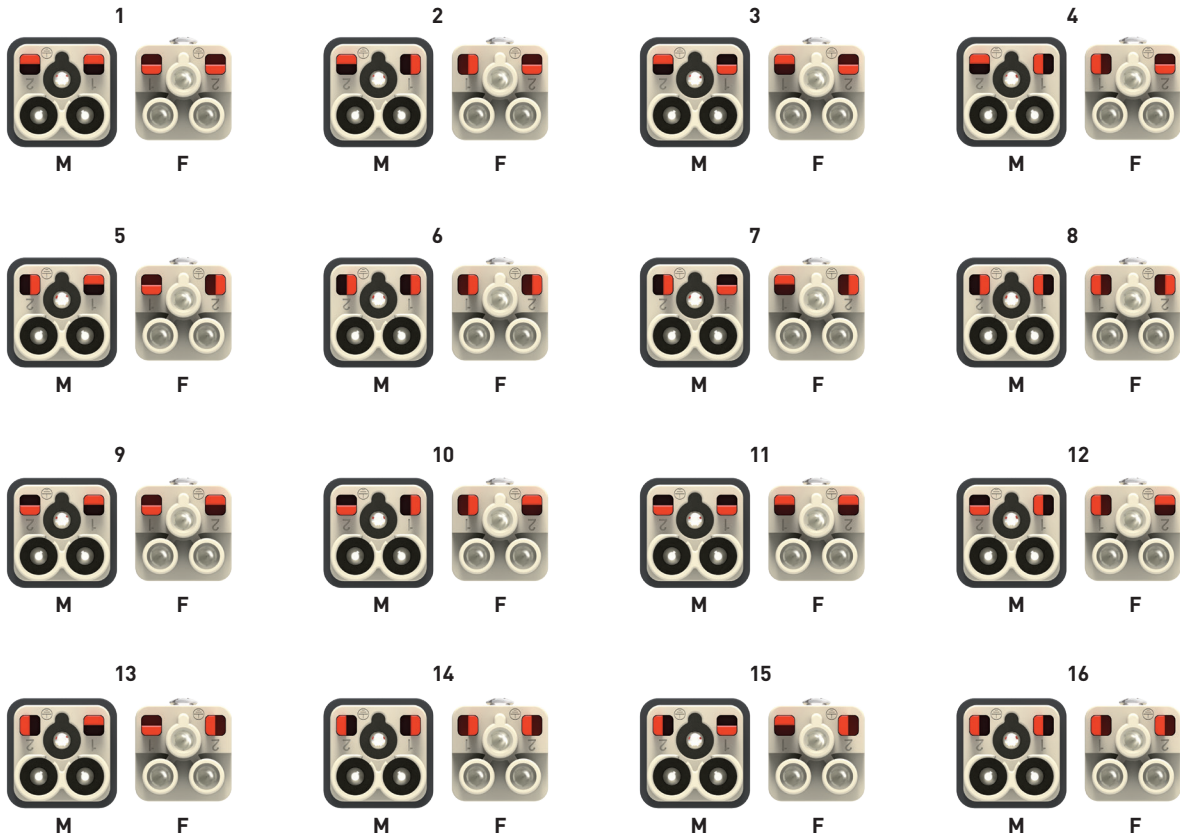

✍ It is possible to achieve up to **16 different codings** thanks to the use of **two optional CR Q02 coding pins: 4 coding pins for each connector coupling**. It is possible to install two pins with 4 positions each.

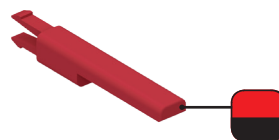

**CR Q02 coding pins**

**M= male insert**  
**F = female insert**

# CKM termination connector

termination connector  
for CKF/CKSF 03 inserts

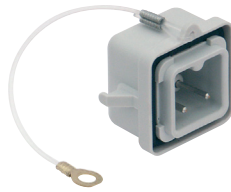

description	part No.
-------------	----------

with pegs and seal, connects pole 2 with pole 3  
with pegs and seal, connects pole 1 with pole 2

**CKM 03 T1**  
**CKM 03 T3**

characteristics according to EN 61984:  
**10A 400V 4kV 3**

When the termination connector is mated with a CKF/CKSF/CKSHF 03 insert (complete with an enclosure with lever), it performs a dual function:  
- connects two socket insert poles  
- acts as a cover (IP65 protection rating compliant with EN 60529 standard, with lever closed).

**CKM 03 T1**

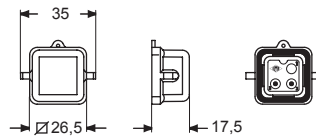

**CKM 03 T3**

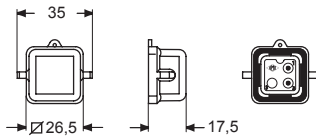

- interconnected male contacts

ACCESSORIES

# CQAM termination connector

termination connector  
for CQF 12 insert

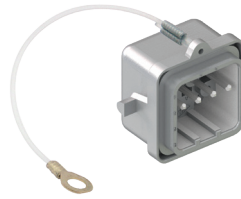

coding pin  
for CQAM 12 T1



description	part No.	part No.
-------------	----------	----------

with pegs and seal, connects pole 5 with pole 6  
and pole 7 with pole 8  
coding pin for termination connectors CQAM 12 T1

**CQAM 12 T1**

**CR Q03**

- characteristics according to EN 61984:  
**10A 400V 6kV 3**  
**10A 400/690V 6kV 2**

When the terminal connector is mated with a CQF 12 insert (complete with an enclosure with lever), it performs a dual function:  
- connects two socket insert poles  
- acts as a cover (IP65 protection rating compliant with EN 60529 standard, with lever closed).

CR Q03 code pins can be used with CQAM 12 T1, in this case the CQF 12 inserts must be provided by CR Q12

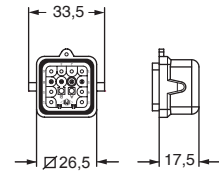

- interconnected male contacts

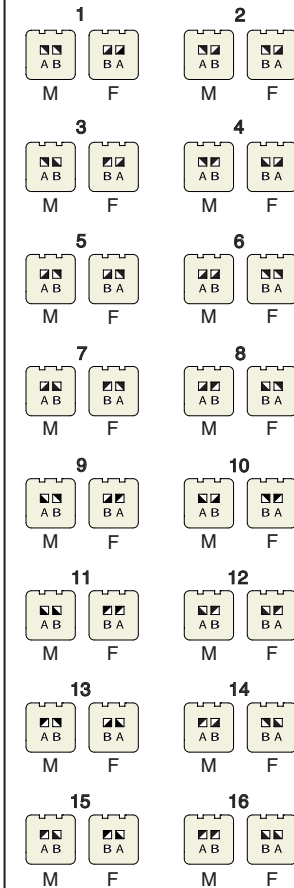
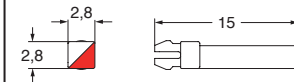

(A B) CQ 12 coding pin

M = male insert  
F = female insert



# CR bridges for delta connection

inserts

- CQF \* 12 poles + ⊕
- CDDF 24, 42, 72 (144), 108 (216) poles + ⊕
- CX 17 DF (MIXO) 1 modulo

\* for enclosures C-TYPE series (CKA/MKA .../VS) only

bridges for delta connection

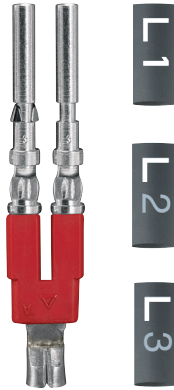

Example of DELTA connection using inserts CQ 12

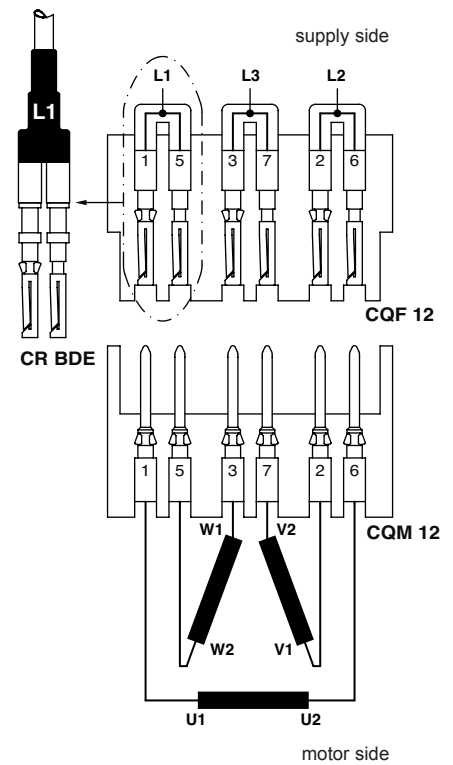

description

bridge with 2 female 10A contacts, silver plated and open type crimp barrel

part No.

CR BDE

NOTE:

The typical use of the product requires three bridges each with its shrinking tube with L1 / L2 / L3 marking to identify the phases in the wiring.

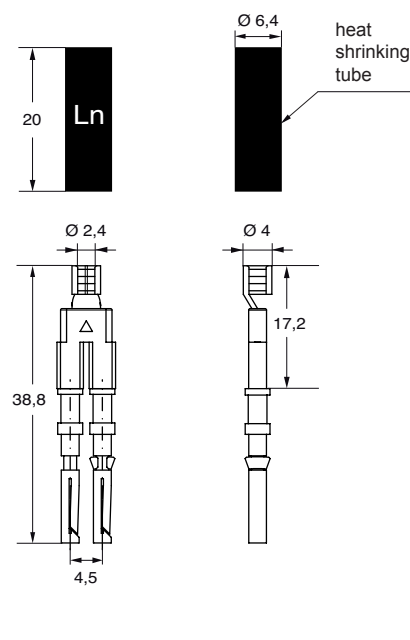
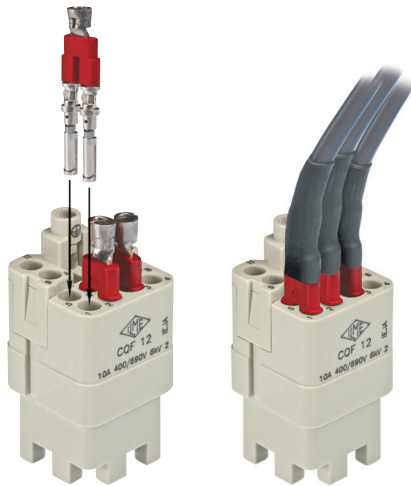

1-5	BRIDGE L1 (winding U1/W2)
2-6	BRIDGE L2 (winding V1/U2)
3-7	BRIDGE L3 (winding W1/V2)
4	auxiliary circuit
8	auxiliary circuit
9	auxiliary circuit
10	auxiliary circuit
11	auxiliary circuit
12	auxiliary circuit
⊕	protective earth

- 1 - Cut and strip the wires as shown in **Drawing A**.
- 2 - Crimp the contacts on the auxiliary wires and the bridge end to the phase wires (3 units) using CRPZ pliers and CRD matrix (position 2,5).
- 3 - Insert the insulating heat shrinking tubes on the bridges, their end must be aligned with the position ⊗. Then heat them at 90/100 °C till they shrink over the wires.
- 4 - Insert the 3 bridges according to the **Drawing B**.

For wires with cross-section ranging from 1,5 to 2,5 mm<sup>2</sup> (16-14 AWG), crimp connection with **CRPZ** pliers (model CEMBRE IDT) and **CRD** matrix.

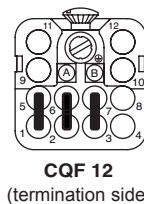
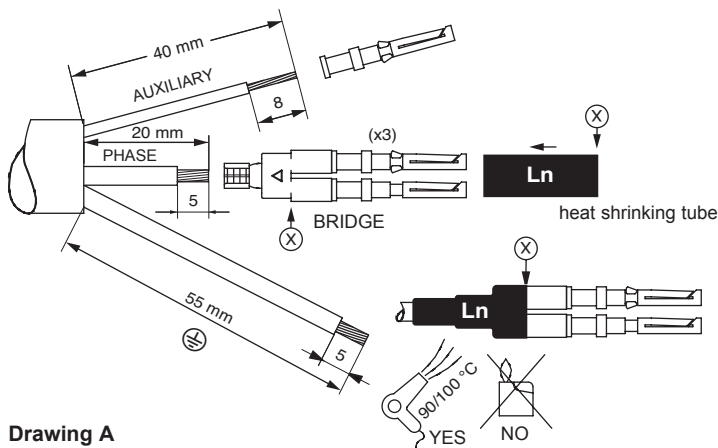

Drawing A

Drawing B

# CR bridges for star connection

inserts

- CQF 12 poles + ⊕
- CDDF 24, 42, 72 (144), 108 (216) poles + ⊕
- CX 17 DF (MIXO) 1 modulo

bridges for star connection



description

part No.

bridge with 3 female 10A contacts, silver plated

**CR BST**

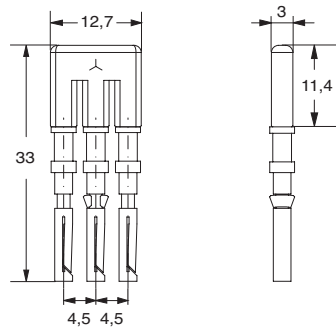
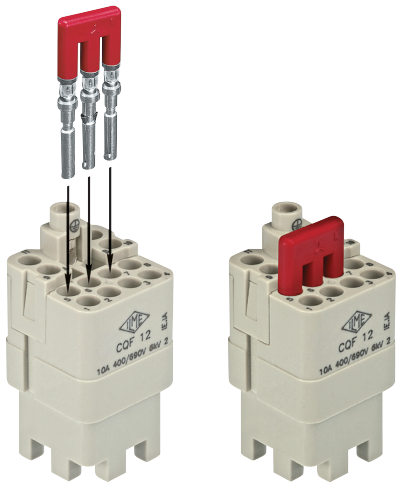

Example of STAR connection using inserts CQ 12

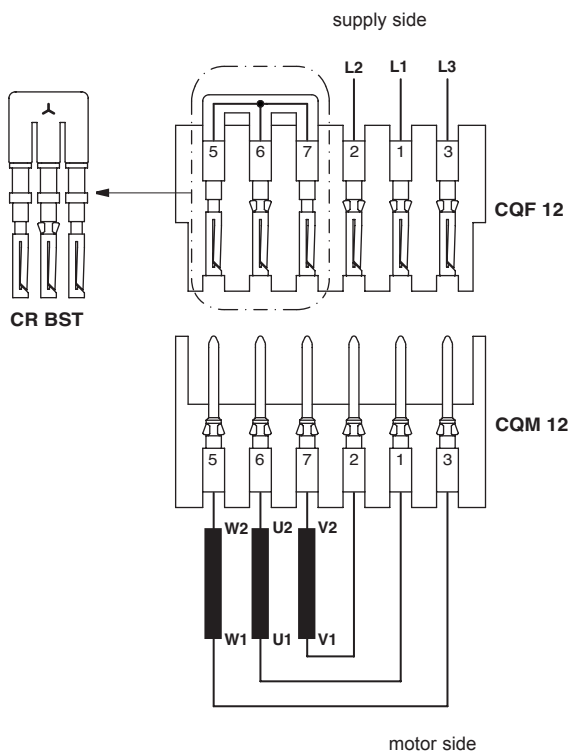

5-6-7	BRIDGE W2-U2-V2
1	L1
2	L2
3	L3
4	auxiliary circuit
8	auxiliary circuit
9	auxiliary circuit
10	auxiliary circuit
11	auxiliary circuit
12	auxiliary circuit
⊕	protective earth

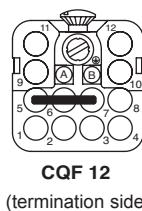

# CHCP protection cover

enclosures

size "44.27", "57.27", "77.27", "104.27"

for versions:

- C-TYPE IP65/IP66
- C7 IP67 stainless steel lever
- V-TYPE IP65/IP66 stainless steel lever
- BIG hoods
- W-TYPE for aggressive environments
- EMC
- 180 °C
- central lever
- LS-TYPE

dust protection cover

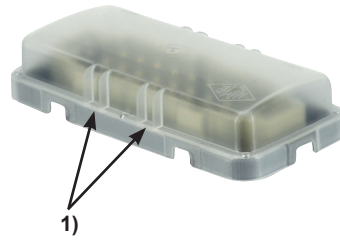

painting protection cover 2)



description

part No.

part No.

for housings and hoods with 1 or 2 levers, with 2 or 4 pegs  
 size "44.27"  
 size "57.27"  
 size "77.27"  
 size "104.27"

**CHCP 06**  
**CHCP 10**  
**CHCP 16**  
**CHCP 24**

**CHCP 10 V**

1) Possibility of using cable ties to increase the retention of the insulating cover on the hood.

2) For housings and hoods with gasket only.

**CHCP**

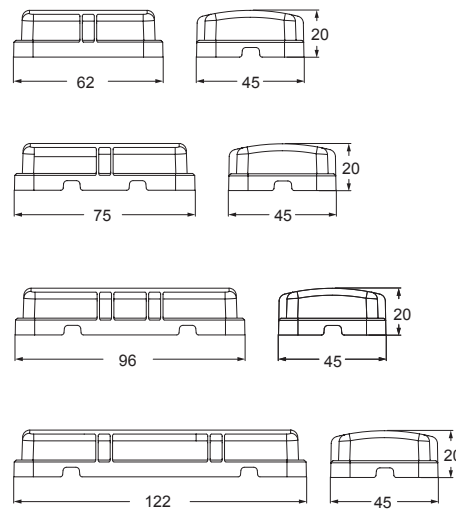

**CHCP 10 V**

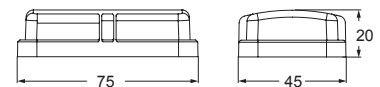

ACCESSORIES

# CGKCP - CGCP protection cover

for versions:  
- IP68  
size "21.21", "44.27", "57.27", "77.27", "104.27"

dust protection cover,  
for housings

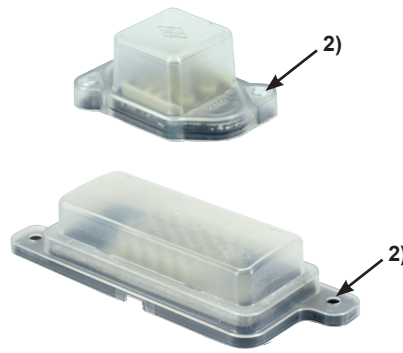

dust protection cover,  
for hoods

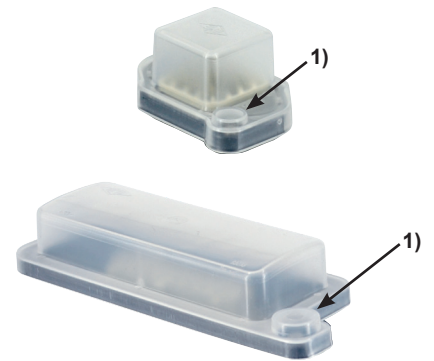

description	part No.	part No.
-------------	----------	----------

for housings and hoods  
size "21.21"  
size "44.27"  
size "57.27"  
size "77.27"  
size "104.27"

**CGKCP FX**  
**CGCP 06 FX**  
**CGCP 10 FX**  
**CGCP 16 FX**  
**CGCP 24 FX**

**CGKCP MB**  
**CGCP 06 MB**  
**CGCP 10 MB**  
**CGCP 16 MB**  
**CGCP 24 MB**

- 1) Possibility of using cable ties to increase the retention of the insulating cover on the hood.
- 2) Possibility to fix by screw:
  - CGKCP FX: 2xM3
  - CGCP FX: 2xM6

**CGKCP FX**

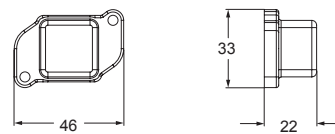

**CGCP FX**

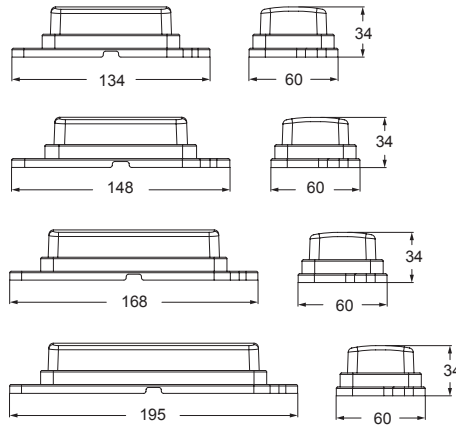

**CGKCP MB**

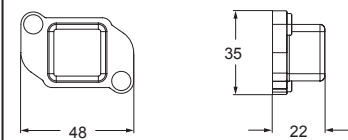

**CGCP MB**

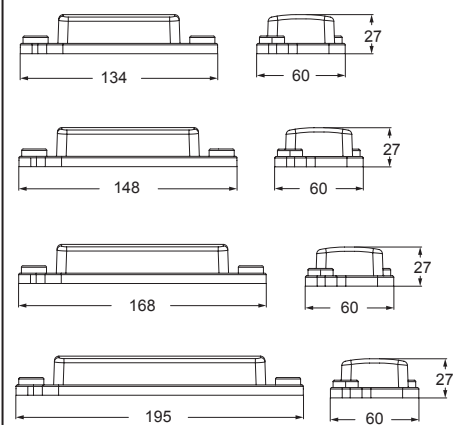

# CBGF CR TM-1

## insert joining block

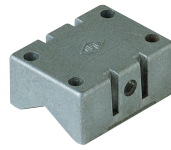

## metal replacement handles

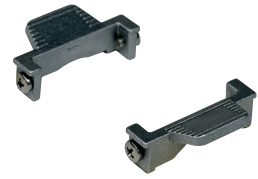

description

part No.

part No.

made of die cast aluminium alloy  
to mate two inserts (see below)  
to replace thermoplastic handles  
2 component kit for dual lever enclosures <sup>1)</sup>

**CBGF**

**CR TM-1**

<sup>1)</sup> can only be used on dual lever enclosures sizes 57.27, 77.27 and 104.27

### CBGF combination block

- Allows two "44.27 size" inserts to be inserted in "104.27 size" enclosures and on the following COB series items: COB TCQ, COB 24 BC, COB TSF, COB TSFS, COB 24 CMS
- Allows female inserts and male inserts in the same enclosure or mounting
- Allows mixed type inserts in the same enclosure or mounting (for example, 6 poles 16A CNEF + 24 poles 10A CDDF)

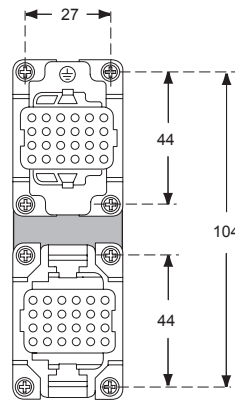
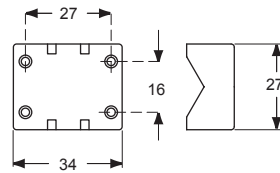
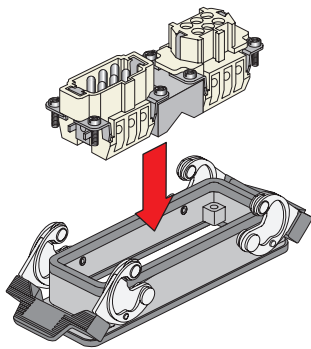

### NOTE

Inserts shown in the drawing are just an example; any "44.27" sized inserts may be combined in a "104.27" housing, including of different gender

C-TYPE enclosures:

**size "104.27"** from page 412

panel supports:

**COB** page 652 - 653

C-TYPE enclosures (with two levers only):

**size "57.27"** from page 393

**size "77.27"** from page 402

**size "104.27"** from page 412

# CPT - CPES

inserts  
size "104.27"

from page 412

temporary protection cover  
for transportation

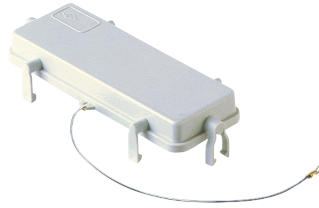

pliers for uncoupling connectors



description	part No.	part No.
-------------	----------	----------

for housings and hoods  
with 1 or 2 levers, with 2 or 4 pegs  
for housings and hoods  
with 2 levers and 4 pegs

CPT 24 \*

CPES

\* Cannot be used with T-TYPE series

**USE**

CPT 24 for enclosures with 2 levers

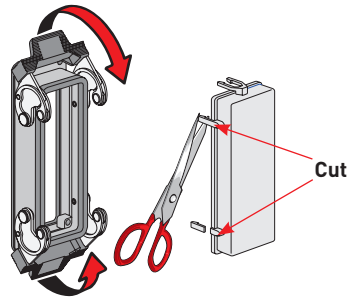

CPT 24 for enclosures with 4 pegs

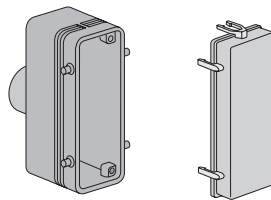

CPT 24 for enclosures with 1 lever

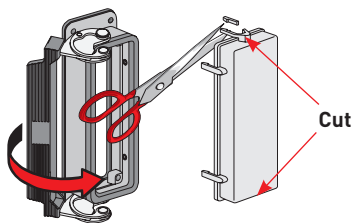

CPT 24 for enclosures with 2 pegs

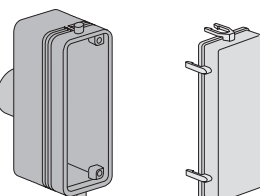

**USE**

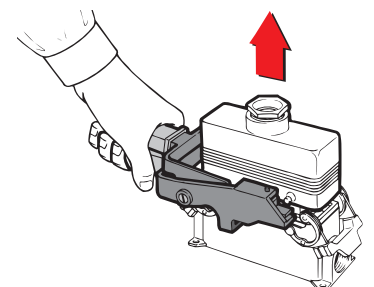
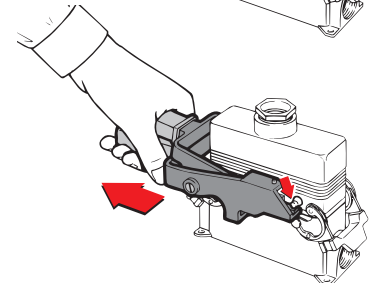
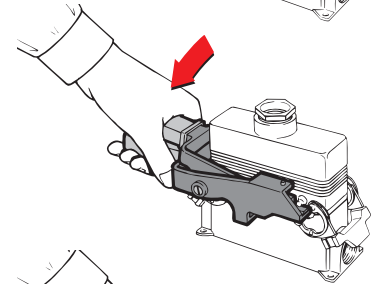
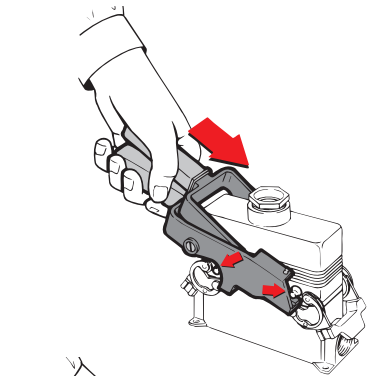

ACCESSORIES

# CR..AD - CR..AD1 - CR..AD2 plates

enclosures

- size "49.16" from page 374
- size "66.16" from page 378
- size "44.27" from page 387
- size "57.27" from page 393
- size "77.27" from page 402

Use M3 passing screws tightened with nut and washer (not included).  
Verify connection continuity of coupled connectors

adapter plates for D-Sub inserts  
(IEC 60807-2) CZ / MZ / MZF enclosures

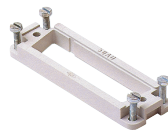

adapter plates for D-Sub inserts  
(IEC 60807-2) CH / CA and MH / MA / MF enclosures

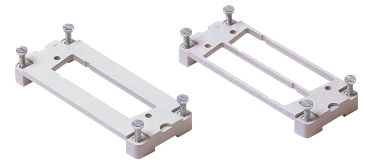

description	part No.	for enclosures size	part No.	for enclosures size
for 1 D-Sub insert 9 poles (not included)	CR 09 AD	"49.16"	CR 09 AD1	"44.27"
for 1 D-Sub insert 15 poles (not included)	CR 15 AD	"49.16"	CR 15 AD1	"44.27"
for 1 D-Sub insert 25 poles (not included)	CR 25 AD	"49.16"	CR 25 AD1	"57.27"
for 1 D-Sub insert 37 poles (not included)	CR 37 AD	"66.16"	CR 37 AD1	"77.27"
for 1 D-Sub insert 50 poles (not included)	CR 50 AD	"66.16"	CR 50 AD1	"77.27"
for 2 D-Sub inserts 9 poles (not included)			CR 09 AD2	"44.27"
for 2 D-Sub inserts 15 poles (not included)			CR 15 AD2	"44.27"
for 2 D-Sub inserts 25 poles (not included)			CR 25 AD2	"57.27"
for 2 D-Sub inserts 37 poles (not included)			CR 37 AD2	"77.27"
for 2 D-Sub inserts 50 poles (not included)			CR 50 AD2	"77.27"

**Plates CR...AD, CR...AD1 and CR...AD2**  
For machinery or command equipment that need connection with programming and control electronic devices. The plate housings have notches for the rear insertion of cabled D-Sub inserts.

**CR...AD**  
mounting on bulkhead housings and hoods  
one-way mounting in bulkhead housings or hoods.

**CR...AD1 and CR...AD2**  
mounting on bulkhead housings (Figure 1)  
The D-Sub connector must be mounted on the side marked with the letter "A"

**Mounting on hoods (Figure 2)**  
The D-Sub connector must be mounted on the side marked with the letter "T"

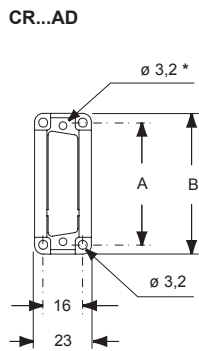

\* For passing screws type M3

The electrical continuity is guaranteed only if mounted in our enclosures.

part No.	A	B
CR 09 AD	49,5	56,5
CR 15 AD	49,5	56,5
CR 25 AD	49,5	56,5
CR 37 AD	66	73,5
CR 50 AD	66	73,5

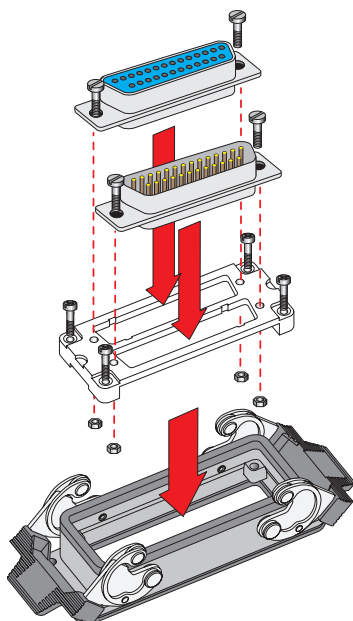

CR...AD1

Figure 1

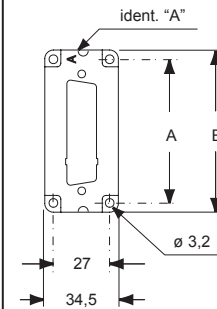
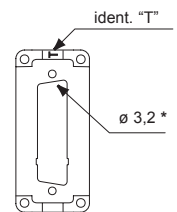

Figure 2



\* For passing screws type M3

CR...AD2

Figure 1

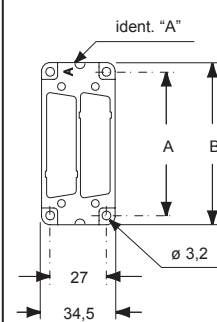
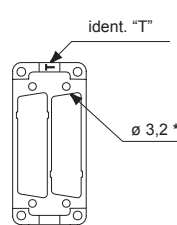

Figure 2



\* For passing screws type M3

part No.	A	B
CR 09 AD1 / 2	44	51,5
CR 15 AD1 / 2	44	51,5
CR 25 AD1 / 2	57	64,5
CR 37 AD1 / 2	77,5	85
CR 50 AD1 / 2	77,5	85



# SDS - CHSDS kit for control equipment

enclosures \*)  
 size "104.62"  
 C-TYPE IP65/IP66  
 \*) normally bulkhead type

page:  
 430

kit for control equipment  
 plate only



kit for control equipment  
 plate with enclosure



description	part No.	for enclosures	part No.
-------------	----------	----------------	----------

with Schuko® socket 16A and 2 seats for:  
 CR 09 AD, CR 15 AD, CR 25 AD plates  
 with Schuko® socket 16A and 2 seats for:  
 CR 09 AD, CR 15 AD, CR 25 AD plates

**SDS**

CHI 48 LS

**CHSDS**

### Kit for control equipment

For machinery or command equipment that need connection with programming and control electronic devices.

The kit includes the Schuko® socket and 2 seats for the CR...AD plates (not included) for D-sub inserts (not included).

Personal computers, notebooks or printers can be power supplied using a 16A socket.

Monitors, printers and other peripheral devices may be interfaced using D-sub connectors

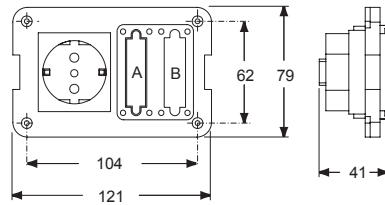

Closed seat "A" for use with one insert only. The closing is achieved by means of a plastic membrane that can easily be removed if the second seat is required.

CR.. AD plates to be ordered separately

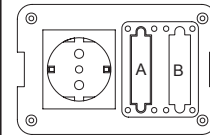
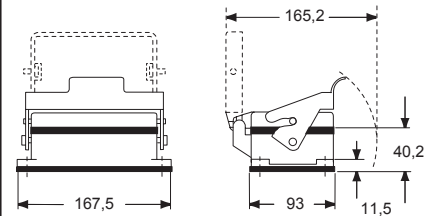

CR...AD plates usable

part No.

<b>CR 09 AD</b>	for 1 D-sub insert 9 poles (not included)
<b>CR 15 AD</b>	for 1 D-sub insert 15 poles (not included)
<b>CR 25 AD</b>	for 1 D-sub insert 25 poles (not included)

housing panel cut-out

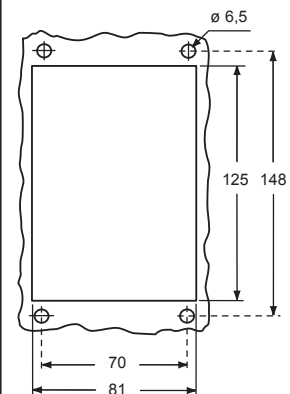

# CRH - CRZ closure and reduction plate

enclosures

- size "44.27"
- size "57.27"
- size "77.27"
- size "104.27"

- from page 387
- from page 393
- from page 402
- from page 412

"104.27" closure plate



"104.27" reduction plate



description	part No.	part No.
-------------	----------	----------

in autoextinguishing thermoplastic resin with gasket in vinyl-nitrile elastomer

**CRH 24**

in self-extinguishing thermoplastic resin with gasket in vinyl-nitrile elastomer

- for bulkhead mounting housings \* size "44.27"
- for bulkhead mounting housings \* size "57.27"
- for bulkhead mounting housings \* size "77.27"
- for bulkhead mounting housings \* size "104.27"

- CRZ 06**
- CRZ 10**
- CRZ 16**
- CRZ 24**

\* Cannot be used with T-TYPE series and IP68 CG/MG series

**CRH 24**

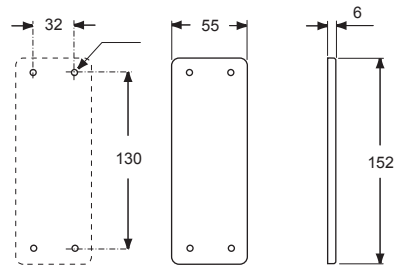

**CRZ**

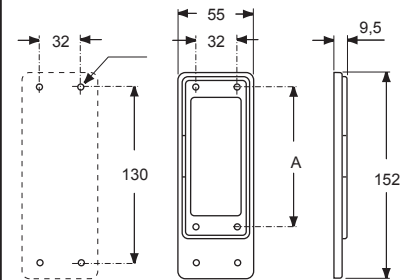

CRZ	A
06	44
10	44
16	57
24	77,5

ACCESSORIES

# CX BES extraction tool

extraction tool for MIXO BUS connectors



description

part No.

for the extraction of the BUS shielded connectors  
from the MIXO BUS insert

**CX BES**

## The crimping concept

The crimp connection is an irreversible, non-reusable connection between one or two conductors and a crimp contact. It is obtained by compression deformation (cold forming) and consequent reshaping of the contact crimping stem, or crimp barrel. A good crimp connection is provided by a suitable combination between the crimping dies, the contact crimp barrel (hence the crimp contact), and the cross-section of the conductor.

These considerations refer to crimped connections made with flexible copper conductors of class 5 (flexible) or 6 (more flexible than class 5) according to EN IEC 60228 standard.

Solid copper conductors (class 1) or conductors made by other materials (aluminium, iron, etc.) often require special precautions for both crimp contacts and crimping tools, to be agreed upon with the manufacturer.

The main technical advantages provided by crimped connections over soldered connections are:

- Independence from temperature, being this a “cold” process, performed without using heat and not requiring further materials.
- Elimination of the contact uncertainties due to cold solders.
- No degradation of the elastic characteristics of the female contacts (a problem that arises with soldering temperatures).
- No health risks connected with the use of heavy metals or fumes generated from the soldering process.
- Preservation of the conductor's flexibility immediately beyond connection.
- No conductors with burned, discoloured or overheated insulating material.
- Excellent reproducibility of the performances of the electrical and mechanical connections.
- Easier production controls.

Other advantages obtained by crimping connections over screw-type connections are:

- Lower voltage drop across the connection.
- High stability in time even in the presence of vibrations.
- High durability in presence of corrosion (gas-tightness).
- Individual insertion of the contacts in the connector (it is possible to eliminate unnecessary contacts).
- Less time required for connection.
- Possibility of pre-production of the terminated conductors with crimp contacts.
- Easy replacement of individual contacts during maintenance.
- Possibility of selectively isolating the circuits during maintenance via the extraction of the contacts from the connector.

The crimped connections for wire sections up to 10 mm<sup>2</sup> are covered by the EN 60352-2:2006 European standard equivalent to the IEC 60352-2 Issue 2 (2006-02) international standard.

The **EN 60352-2** standard also includes a practical guidance, which lists the following main points.

The quality of a crimped connection is mainly affected by the quality of the materials used and by the condition of the surfaces both of the crimp contact (in particular the crimp barrel) and of the conductor.

To ensure a good quality crimped connection, an essential parameter is the mechanical retention of the conductor in the contact. The standard makes a distinction between the closed crimp barrel, inherently stronger, and the open crimp barrel. ILME crimp contacts are closed crimp barrel contacts, with inspection hole which ensure a higher mechanical performance compared to the open barrel crimp contacts, such as better mechanical robustness and stability during operation. They have been high speed precision-machined, thus ensuring a better electrical performance (better conductivity).

In 2002 the Amendment 2 of the previous IEC standard had controversially unified the minimum tensile strength for open crimp barrel contacts (curve B of former Figure 5) and closed crimp barrel contacts (curve A of former Figure 5) making them both equal to the lower values (those of curve B), which can be achieved by open barrel crimp contacts. This change has determined an arguable relaxation of the suitability requirements both for closed crimp barrel, typically larger, machine turned and for crimp tools specially made for these contacts. Several industries continue to prefer the higher performance ensured by closed crimp barrel contacts, the only ones able to ensure the higher resistance to tensile stress values believed to be essential for the most demanding industrial applications.

Therefore, ILME continues to refer to curve A of Figure 5 illustrated in the EN 60352-2:1994 standard: ILME closed crimp barrel contacts, used with flexible copper wires, featuring a cross-sectional area included in the ranges shown and correctly crimped with the recommended tools, ensure tensile breaking resistant connections at least equal to the values shown in the table below (for reference, the corresponding  $R_{\sqrt{S}}$  unified tensile stress load value is also shown [N/mm<sup>2</sup>]). See Table 1.

Section S		Resistance to traction $R_t$ (N)	$R_t/S$ (N/mm <sup>2</sup> )
AWG	mm <sup>2</sup>		
26	0,12	18	150
-	0,14	21	150
24	0,22	33	150
-	0,25	37,5	150
22	0,32	48	150
-	0,37	55,5	150
20	(0,6)	75	150
-	0,75	112,5	150
18	(0,82)	125	150
-	1	150	150
16	(1,3)	195	150
-	1,5	220	147
14	(2,1)	300	143
-	2,5	325	130
12	(3,3)	430	130
-	4	500	125
10	(5,3)	635	120
-	6	650	108
7	10	1000	100
		(1300)	(130)
-	16	1650	103
-	25	2300	92
-	35	2800	80
	50	3300	66
-	70	3900	56

Table 1.

**NOTE** - For 10 mm<sup>2</sup> wire sections, the resistance to tensile stress shown in *italics* are those specified in the NF F 61-030 standard (for 10 mm<sup>2</sup>, the value in brackets).

The basic criterion used for the tensile strength values required by EN 60352-2 standard is that such resistance is at least equal to 60% of the per unit breaking load of the same annealed copper conductor.

This applies to conductor cross-sectional areas up to about 1,5 mm<sup>2</sup>; above this cross-section, the ratio is slightly lower, as retention is also affected by friction, which increases linearly with the housing diameter, whilst the cross-section increases by the square.

IEC/EN 60352-2 standard, which historically targeted the electronics industry, restricts its requirements to crimp connections for conductors with a maximum cross-sectional area of 10 mm<sup>2</sup>. For cross-sections higher than 10 mm<sup>2</sup>, up to 70 mm<sup>2</sup>, the standard to refer to is the NF F 61-030:1989 French standard which relates to electrical connectors to be used on board of railway rolling stock, in particular for large crimp contacts, such as those manufactured by ILME.

**NOTE** - Alternatively, for wire sections between 35 mm<sup>2</sup> and 300 mm<sup>2</sup>, EN 61238-1:2003 standard can be referred to.

This standard requires constant  $R_t/S$  values equal to 60 N/mm<sup>2</sup>, lower than those established by the above mentioned French standard.

## Selecting the crimping tool and relevant controls

When you have selected quality crimp contacts and conductors, the next and most important step is to select the correct crimp tool. The practical guidance of standard EN 60352-2 provides the following recommendations on the subject, listing some of the ideal requirements for crimping tools, some optional characteristics, but, above all, it provides a preview of the indispensable controls:

- a) The crimping tools and the contacts used shall be supplied by the same manufacturer, otherwise the user shall assume all responsibility for the quality and reliability of the crimp connections.
- b) The crimping tools must function correctly and provide a correct crimp without damage to the pin or the component to crimp.
- c) In order to obtain a reliable crimp connection, a crimping device with a mechanism that controls the entire crimping cycle shall be used. At the end of the crimping cycle the handles and the ratchet must return to the open position.
- d) In all cases the crimping operation shall be made in one single phase, with no further interventions.
- e) The removable parts of the tool such as the crimping dies and the locators must be designed in such a way as to make it possible to be inserted within the tool only in the correct manner.
- f) The tools must be supplied with the appropriate means for a correct positioning of the pins to be crimped and of the conductors during crimping.
- g) The tools must be designed in such a way so that only the necessary adjustments may be made.
- h) The action of the tool must be such that both the pin to be crimped and the fixture of the isolation (when present) are respectively crimped or compressed with a single action.
- i) The design of the tool must ensure that the dies for a particular tool may be interchangeable within tools of the same type. If they are not interchangeable, the identification of tools for which they are suitable must be marked on the dies.
- j) The tools may be designed so as to produce a marking or coding of the die on the pin to be crimped so that the crimping may be checked for verification of the correct die.
- k) The design of the tool must allow the verification of the dies with gauges to measure wear. The gauge verification method must be that specified by the manufacturer of the tools.

With suitable flexible copper conductors, the crimping tool proposed by ILME gives 8-indent crimping (see figure) in conformity with standard EN 60352-2. Periodic control of the wear of the crimping dies can be carried out with the appropriate "go – no go" gauges (to be purchased separately). For extra operational details, consult the following pages on tools, and the relevant instruction sheets and/or use and maintenance manuals.

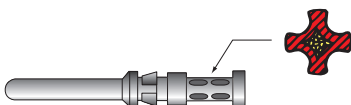

The manual and automatic crimping tools selected by ILME are carefully designed to ensure symmetrical deformation of the crimping area of the contact and wire, by means of their own, internal high pressure forming parts. The positioner ensures that the wire and crimp contact meet in the appropriate part of the tool. Sprung mechanisms built into the tools ensure that the contacts are not inserted in the tool before the indenters are fully open, and that the tool does not open before the crimping process has been completed.

The **CIPZ D** (for 5A crimp contacts), **CCPZ MIL** (for 10A and 16A crimp contacts) and **CXPZ D** (for 40A crimp contacts) manual crimping tools are suitable for use when compressed air sources are unavailable, for low or medium-low workloads.

The **CCPZ RN** (for 10A, 16A and 40A crimp contacts) manual crimping tool is also suitable for low or medium-low workloads.

All the above tools provide 8-indent crimping.

The **CCPZ TP** (for 10A and 16A crimp contacts) and **CXPZ TP** (for 40A crimp contacts) manual crimping tools are also suitable for low or medium-low workloads and provide a "square shaped" crimping cross-section. Crimped connections produced by these tools are in compliance with the requirements of EN 60352-2.

The **CCPZP** pneumatic crimping bench tool without automatic positioner (for 10A and 16A crimp contacts) is suitable for use in the workshop (where compressed air is available) for high or medium-high workloads. Using the same manual crimping tool turrets, it is possible to change rapidly from crimping on male contacts to crimping on female contacts of the same series (10A and 16A).

The **CCPZPA** pneumatic crimping bench tool with automatic positioner (for 10A and 16A crimp contacts) is suitable for workshop jobs (where compressed air is available) for medium-high or high workloads. It is recommended in particular for crimping high quantities of contacts that are the same type or have the same section, thus saving a significant amount of time thanks to automatic operation and reduced operator fatigue. Where the type or kind of contact must be changed frequently, it is preferred to use the version without automatic positioner.

The **CXPZP D** pneumatic crimping bench tool without automatic positioner (for 40A crimp contacts) is suitable for use in the workshop (where compressed air is available) for high or medium-high workloads. By using the same positioners as those of manual crimper CXPZ D, the size of a contact can be rapidly changed with one of the same type.

The semiautomatic stripping-crimping machine, type **ZFU-CD**, is suitable to be used in workshops (where an electrical or pneumatic power supply is available) and for heavy workloads. It enables to produce large amounts of crimped connections in less time because of the possibility of simultaneously carrying out stripping and crimping operations. The contact and tool replacement operations, which are minimized because of the pre-set programs that can be stored and customized by the user, require the production to be programmed to reduce downtime. When a sequential processing is required despite the economic advantages offered by the above-described solution, it is preferable to use pneumatic bench pliers without the above-described positioner or one of the manual pliers.

In any case, the quality of the results from the crimping tools, combined with the ILME crimp contacts, is identical and at the highest market levels, exceeding the requirements of the standard EN 60352-2.

Although the crimping appliances and tools suggested here include a set of control automatisms and mechanisms, which prevent the chief misunderstandings and errors, the operator is advised to always take care not to work in inappropriate conditions.

# The crimping operation

The practical guide in standard EN 60352-2 supplies further general information regarding crimp contacts for multipole connectors.

## 1. Insertion of the conductor in the crimp contacts

The conductor must be correctly positioned in the pin to be crimped. The crimping indentations must be correctly positioned on the foot to be crimped. There must be sufficient space, in conformity with the manufacturer's instructions, between the end of the insulating material of the conductor and the pin to be crimped ("d").

As a general rule, the stripping length is equal to the pin insertion depth + 1 mm (for sections up to 1 mm<sup>2</sup>) and + 2 mm (for sections from 1 to 10 mm<sup>2</sup>) \*. When using closed crimp pins with an inspection hole, the crimp conductor must be visible through the inspection holes.

\* Keeping the conductor strands visible above the contact collar enables you to check correct, i.e. make sure no strands have been cut. This also ensures a certain flexibility for the connection, by not transmitting to the contact any flexure stresses caused by installation. However, in practice, some operators give priority to insulation, by reducing to zero the gap between cable insulation and the contact collar.

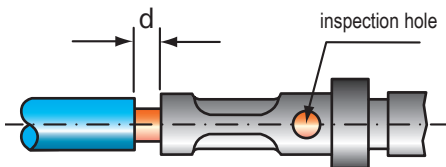

## 2. Insertion of crimped contacts in the connector insert

It is recommended that the crimped contacts be perfectly straight and inserted within the contact slots in a single operation and without excessive force until a clicking sound is heard.

The correct retention of the contact should be verified with a light pulling of the wire. Non alignment of the crimped contacts must be avoided because this could cause possible loosening of the retention springs and consequently jeopardise the retention of the contact in the insert.

For small section conductors ( $\leq 0,35 \text{ mm}^2$ ) or for specific application, the use of the insertion tool specified by the manufacturer is recommended.

## 3. Removal of inserted contacts

In the case of incorrect insertion or wiring substitution, inserted contacts may only be removed using the removal tools specified by the manufacturer.

## 4. Mounting and flexure of multi-wired bundles or multipolar cables with crimp contacts

Bundles of conductors or multipolar cables with crimp contacts for multipole connectors must not cause stress to the inserted contacts with their weight as this would cause the contacts to bend over to the coupling area of the connectors and consequently damage them. The connectors must therefore be provided with cable clamps or the conductor bundles or multipolar cables must be mounted as described in the figures.

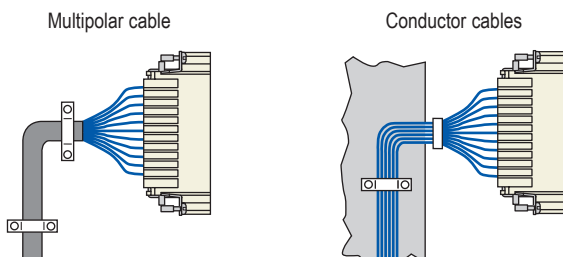

If the conductor bundles or the multipolar cables have to be immediately folded over on the back of the connector insert, it is recommended not to use any mechanical force in the axial direction with respect to the coupled contacts. The figure shows a correct bending and clamping of the multiwire bundles using the crimp contacts.

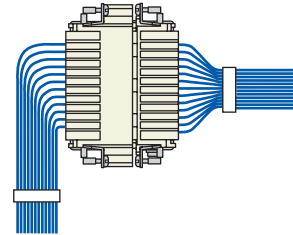

## 5. Coupling and uncoupling of multipolar connectors with crimp contacts

In order to prevent stress on the crimp contacts, the connectors must be coupled and uncoupled in the axial direction with respect to the contacts, without touching the conductor bundles or cables.

Standard DIN 43652 (incorporated into specification EN 175301-801) that applies to the ILME inserts of the CD series (this recommendation is also valid for the CDD series) prescribes a maximum deflection from the axis of  $\pm 5^\circ$  on the greater side and  $\pm 2^\circ$  on the smaller side.

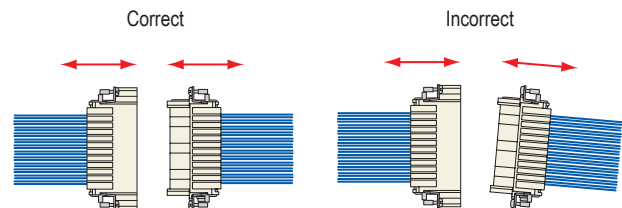

To keep the play within this limit, especially during the uncoupling phase, guide pins CRM and CRF may be used. The use of ILME pliers (code number CPES) is recommended for the uncoupling operations for CD inserts (64 poles) and CDD inserts (108 poles). The pliers work on the fulcrum and lever principle and perform the following main tasks:

- I - Reduce effort and coupling times to the minimum, even when working in the most impractical and inaccessible points.
- II - Perform the uncoupling of multipolar connectors in full conformity of standard DIN 43652 (now EN 175301-801).

The pliers allow the extraction of the inserts to be made perfectly axially with respect to the contacts, evenly distributing the pressure on four points (housing pins).

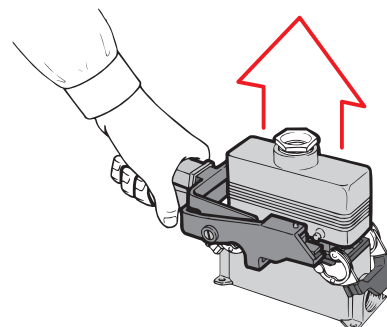



# Tools and accessories for crimp contacts

for contacts of inserts series:		page:
CD	(10A)	66 - 74
CDD	(10A)	76 - 83
CDC	(16A)	104 - 106
CCE	(16A)	130 - 135
CMCE	(16A)	137 - 145
CQE	(16A)	168 - 173
CQEE	(16A)	176 - 177
CQ	(10A/16A)	186 - 193
CX 8/24	(16A/10A)	194
CX 6/36 *	(10A)	198
CX 12/2 *	(10A)	199
CX 6/6 *	(16A)	206
MIXO	(10A/16A)	241 - 276

\* the underlined polarities indicate those contacts that require the tools shown in this page

## manual crimping tool positioner - gauge



## insertion tool - removal tools replacement tip



description	part No.	part No.
crimping tool for <b>10A</b> and <b>16A</b> contacts DANIELS AF8 model (turret excluded)	<b>CCPZ MIL</b>	
positioner inserts (see note) for <b>10A</b> contacts (CDF and CDM series) for <b>16A</b> contacts (CCF and CCM series)	<b>CCTP 10</b> <b>CCTP 16</b>	
"go / no go" control gauge to verify indenter closure (see note)	<b>CCPNP</b>	
insertion tool for insertion of the contacts into the inserts for crimped contacts up to 0,75 mm <sup>2</sup>		<b>CCINA</b>
removal tools for the extraction of contacts from the inserts for <b>10A</b> contacts <sup>1)</sup> for <b>16A</b> contacts <sup>2)</sup>		<b>CCES</b> <b>CQES</b>
replacement tip for CCES removal tool		<b>CCPR RN</b>

- 1) for CQ, CD, CDD, CX inserts (10A auxiliary contacts) and MIXO module (10A)
- 2) for CQ, CQE, CQEE, CCE, CMCE inserts (excluded 16+2), MIXO module (16A), CX6/6 (16A) and CDC. For CMCE (16+2), CX inserts (contacts 16A insert CX 8/24) using a flat 3 mm screwdriver.

**Notes:**  
**Positioner / Head turret**  
 conforms to international standard MIL-C-22520/1  
 - An interchangeable and indispensable accessory of the CCPZ MIL crimping tool, it precisely positions the contact where crimping is performed. Each series of contacts requires its own turret.

**"go / no go" control gauge**  
 conforms with international standard MIL-C-22520/3  
 - A tool used to periodically check that the crimping tool meets standard requirements.

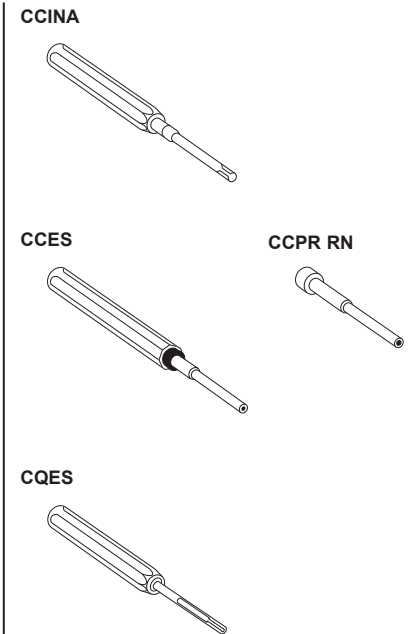
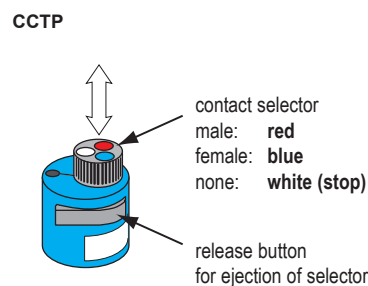
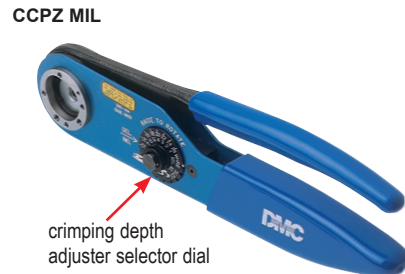
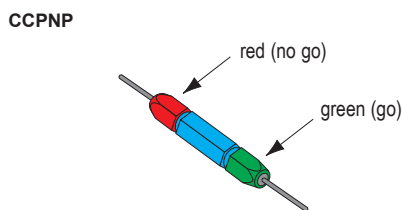

### 16A - CONTACT HEAD TURRET / POSITIONER

CCMA - CCFA CCMD - CCFD		0,14	0,25	0,34	0,5	0,75	1,0	1,5	2,5	3,0	4,0	conductor section
red	blue	mm <sup>2</sup>	mm <sup>2</sup>	mm <sup>2</sup>	mm <sup>2</sup>	mm <sup>2</sup>	mm <sup>2</sup>	mm <sup>2</sup>	mm <sup>2</sup>	mm <sup>2</sup>	mm <sup>2</sup>	AWG
male	female	26	24	22	20	18	17	16	14	12	12	AWG crimping depth adjuster selector CCTP 16
0,3	0,3	5	5	6								
0,5	0,5		6	6	7							
0,7	0,7			6	6	7						
1,0	1,0			6	6	7	7					
1,5	1,5				6	7	7	8				
2,5	2,5					6	6	7	7			
3,0	3,0							6	7	7		
4,0	4,0									7	8	

### 10A - CONTACT HEAD TURRET / POSITIONER

CDMA - CDFA CDMD - CDFD		0,14	0,25	0,34	0,5	0,75	1,0	1,5	2,5	conductor section
red	blue	mm <sup>2</sup>	mm <sup>2</sup>	mm <sup>2</sup>	mm <sup>2</sup>	mm <sup>2</sup>	mm <sup>2</sup>	mm <sup>2</sup>	mm <sup>2</sup>	AWG
male	female	26	24	22	20	18	17	16	14	AWG crimping depth adjuster selector CCTP 10
0,3	0,3	5	5	6						
0,5	0,5				6					
0,7	0,7					6				
1,0	1,0						6			
1,5	1,5							7		
2,5	2,5								7	

# Use and maintenance instructions

## 1. General specifications

The **CCPZ MIL crimping tool** conforms to the international standard MIL-C-22520/1. Crimping is performed with 8 pressure points. The tool is equipped with a geared mechanism to control the complete crimping cycle. **The tool must be equipped with an interchangeable positioner (CCTP) according to the series of contacts to be crimped.**

### 1.1 Crimping range

Conductor cross-sectional area range:  
from 0,14 mm<sup>2</sup> (26 AWG) to 4 mm<sup>2</sup> (12 AWG) for positioner 16A,  
from 0,14 mm<sup>2</sup> (26 AWG) to 2,5 mm<sup>2</sup> (14 AWG) for positioner 10A

#### Caution!

**The handle of the tool must be in the open position when the turret is installed, disassembled or opened. If not, the turret and the crimping tool may be damaged.**

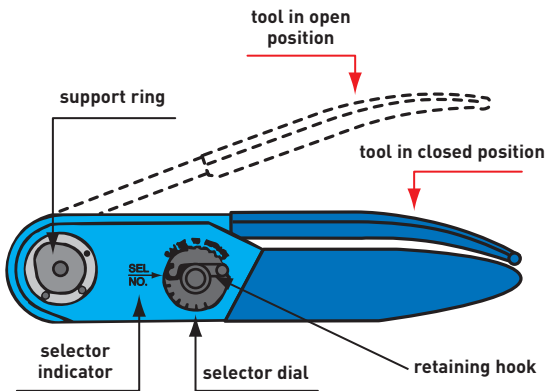

## 2. CCTP positioner installation

- 1 The crimping tool must be in the open position.
- 2 Press the clicking lever that releases the positioner in the adjustment position.
- 3 Position the previously selected CCTP positioner on the support ring located on the crimping tool (matching the special pin on the base of the turret with the corresponding hole on the support ring), aligning the tapped holes with the socket head screws.
- 4 With the CCTP positioner positioned against the support ring, tighten the socket head screws with the 3,5 mm Allen wrench (supplied with the kit).
- 5 Refer to the data plate on the CCTP positioner. From the colour code column, select the colour of the positioner that corresponds to the appropriate code and dimension of the contact to be crimped.
- 6 With the CCTP positioner in the adjustment position, turn the turret until the colour-coded positioner is aligned with the indicator line. Press the turret until it clicks into the connected position.
- 7 Refer to the data plate on the CCTP positioner. From the column indicating the proper conductor section, determine the number that corresponds to the contact being used.
- 8 Remove the retaining hook from the crimping tool selector dial. Lift the selector dial and turn it until the selector number is aligned with the indicator (SEL. NO.). Replace the retaining hook (if necessary).

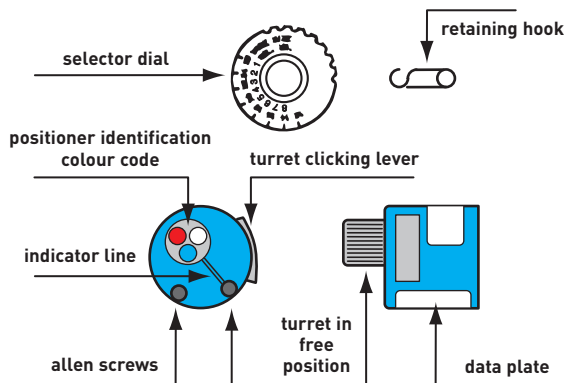

## 3. Crimping instructions

- 1 Insert the contact and the prepared conductor through the opening of the indenter in the turret positioner.
- 2 Tighten the crimping tool handle until the stop gear is released. The tool will return to the open position.
- 3 Check the position of the crimping on the contact crimping foot. Ideally, the crimping should be between the inspection hole and the top edge of the crimping foot.  
The head of the contact should not be squared and the inspection hole should be intact.

## 4. Removing the CCTP positioner

With the crimping tool in the open position, to disassemble the positioner, loosen the socket head screws using the 3,5 mm Allen key wrench (supplied with the kit). After the threads are released from the support ring, pull off the positioner with a straight movement.

## 5. Instructions to check calibration

The operations to check the crimping tool must be carried out with the selector dial in position 4 and the CCPNP gauge.  
**ATTENTION! Do not crimp the gauge.**

### 5.1 Calibration check

Put the crimping tool in the completely closed position.  
"GO" - Insert the end (green) of the gauge as shown (Fig. 1). The gauge must pass freely between the indenter tips.  
"NO GO" - Insert the end (red) of the gauge as shown (Fig. 2). The gauge should not pass through the opening.

Gauge	tool selector pos. No.	Ø A ± 0,00254 mm (GO) green	Ø B ± 0,00254 mm (NO GO) red
CCPNP	4	0,991 (mm)	1,118 (mm)
		0,0390 (IN)	0,0440 (IN)

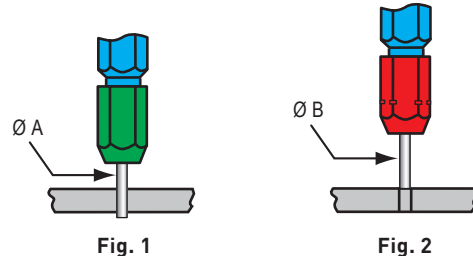

## 6. Crimping tool maintenance

No maintenance is required.

However, it is good practice to keep the indenter tips free from residual deposits of the coloured band (some types of crimp contacts as per MIL standards are identified by coloured bands in the crimping area) and any other debris.

A metal brush may be used for this purpose.

The following is strongly recommended:

- 1 DO NOT immerse the tools in a solution to clean them.
- 2 DO NOT brush oil in the tools to lubricate them.
- 3 DO NOT try to disassemble the tool or repair it.

This is a high-precision manual crimping tool and must be used as such. For automatic crimping operations refer to the CCPZP and/or CCPZA crimping tool models.

# Tools and accessories for crimp contacts

for contacts of inserts series:		page:
CD	(10A)	66 - 74
CDD	(10A)	76 - 83
CDC	(16A)	104 - 106
CCE	(16A)	130 - 135
CMCE	(16A)	137 - 145
CQE	(16A)	168 - 173
CQEE	(16A)	176 - 177
CQ	(10A/16A)	186 - 193
CX 8/24	(16A/10)	194
CX 6/12 *	(10A)	197
CX 6/36 *	(10A)	198
CX 12/2 *	(10A)	199
CX 6/6 *	(16A)	206
RD (HNM)	(10A)	208 - 209
RDD (HNM)	(10A)	210 - 213
RCE (HNM)	(16A)	214 - 217
RQEE (HNM)	(16A)	218 - 219
MIXO	(10A/16A)	241 - 276

\* the underlined polarities indicate those contacts that require the tools shown in this page

## manual crimping tool

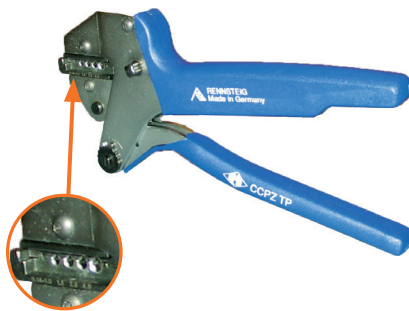

front view showing incorporated crimp dies

## insertion tool

### removal tools - tip



description

part No.

part No.

crimping tool for **10A** and **16A** contacts  
RENNSTEIG model (crimping dies and turret head are included)

CCPZ TP

insertion tool

for insertion of the contacts into the inserts  
for crimped contacts up to 0,75 mm<sup>2</sup>

CCINA

removal tools

for the extraction of contacts from the inserts

for **10A** contacts

for **16A** contacts

CCES

CQES

replacement tip

for CCES removal tool

CCPR RN

**CCPZ TP** is a simple but effective "square shaping" manual crimping tool incorporating discrete (4-size nests) crimping dies and dedicated turret positioner for relevant crimp contacts series and sizes.

CCPZ TP



rear view showing incorporated turret head positioner

CCINA

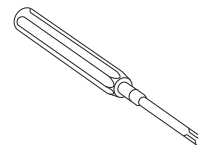

CCES

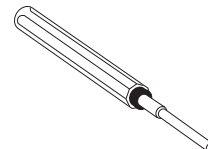

CCPR RN

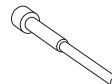

CQES

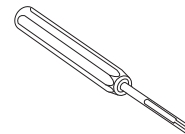

# Tools and accessories for crimp contacts

for contacts of inserts series:		page:
<b>CQ4 03</b>	(40A)	184
<b>CQ 04/2</b>	(40A)	182
<b>CQ 04/2 H</b>	(40A)	183
<b>CX <u>6/12</u> *</b>	(40A)	197
<b>CX <u>6/36</u> *</b>	(40A)	198
<b>CX <u>12/2</u> *</b>	(40A)	199
<b>MIXO</b>	(40A)	237 - 242

\* the underlined polarities indicate those contacts that require the tools shown in this page

## manual crimping tool



front view showing incorporated crimp dies

## removal tool



description	part No.	part No.
-------------	----------	----------

crimping tool for 40A contacts  
RENNSTEIG model (crimping dies and turret head are included)

**CXPZ TP**

removal tool  
for the extraction of contacts from the inserts  
for **40A** contacts

**CXES**

**CXPZ TP** is a simple but effective "square shaping" manual crimping tool incorporating discrete (3-size nests) crimping dies and turret positioner for relevant crimp contacts sizes ranging from size 1.5 to size 6.0. Size 10 requires **CCPZ RN** (Rennsteig PEW 8.75 universal manual crimp tool) or **CXPZ D** (Daniels WA27-309-EP pneumatic tool)

For series CX (40A) contacts (and their corresponding HNM variants series RX) manual crimping tool **CXPZ D** (Daniels M309) up to size 6.0 or CCPZ RN (Rennsteig PEW 8.75) for all sizes – or the pneumatic **CXPZP D** for large volumes of crimps, by providing 8-indent crimping, are recommended for highly demanding applications, such as in transportation.

## CXPZ TP



rear view showing incorporated turret head positioner

# Tools and accessories for crimp contacts

for contacts of inserts series:		page:
<b>CX 6/12 *</b>	(40A)	<b>197</b>
<b>CX 6/36 *</b>	(40A)	<b>198</b>
<b>CX 12/2 *</b>	(40A)	<b>199</b>
<b>MIXO</b>	(40A)	<b>237 - 242</b>

\* the underlined polarities indicate those contacts that require the tools shown in this page

## manual crimping tool positioner - gauge



## removal tool



description	part No.	part No.
crimping tool for <b>40A</b> DANIELS M309 model (turret excluded)	<b>CXPZ D</b>	
positioner (see note) for contacts <b>40A</b>	<b>CXTP 40</b>	
"go / no go" control gauge to verify indenter closure (see note)	<b>CXPNP</b>	
removal tool for the extraction of contacts from the inserts for <b>40A</b> contacts		<b>CXES</b>

**Notes:**

**Positioner**

- An interchangeable and indispensable accessory of the CXPZ D crimping tool, it precisely positions the contact where crimping is performed. Each series of contacts (male or female) requires its own turret.

**"go / no go" control gauge**

- A tool used to periodically check that the crimping tool meets standard requirements.

**CXPNP**

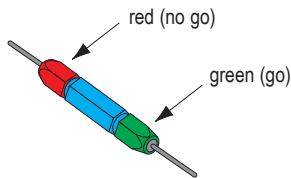

**CXPZ D**

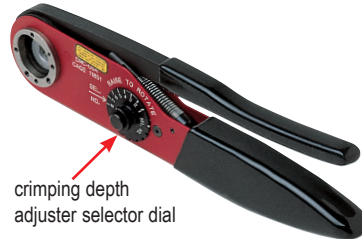

**CXTP 40**

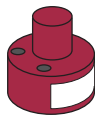

**CXTP 40**

CONTACT	CXMA/CXFA	1.5	2.5	4.0	6.0	10
WIRE SIZE	mm <sup>2</sup>	1,5	2,5	4	6	10
	AWG	16	14	12	10	8
SEL. NO.		5	5	5	7	8
USE WITH		M309				
		WA-27-309-EP				

# Use and maintenance instructions

## 1. General specifications

The **CXPZ D crimping tool** performed with 8 pressure points. The tool is equipped with a geared mechanism to control the complete crimping cycle.

**The tool must be equipped with an interchangeable turret (CXTP) according to the series of contacts to be crimped.**

### 1.1 Crimping range

Conductor cross-sectional area range: from 1,5 mm<sup>2</sup> (16 AWG) to 6 mm<sup>2</sup> (10 AWG).

#### Caution!

**The handle of the tool must be in the open position when the turret is installed, disassembled or opened. If not, the turret and the crimping tool may be damaged.**

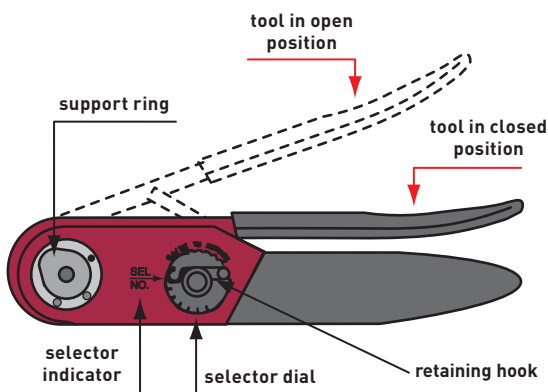

## 2. CXTP positioner installation

- 1 The crimping tool must be in the open position.
- 2 Position the CXTP 40 positioner on the support ring located on the crimping tool (matching the special pin on the base of the turret with the corresponding hole on the support ring), aligning the tapped holes with the socket head screws.
- 3 With the CXTP 40 positioner positioned against the support ring, tighten the socket head screws with the 3,5 mm Allen wrench (supplied with the kit).
- 4 Refer to the data plate on the CXTP 40 positioner. From the column indicating the proper conductor cross-sectional area, determine the number that corresponds to the contact being used.
- 5 Remove the retaining hook from the crimping tool selector dial. Lift the selector dial and turn it until the selector number is aligned with the indicator (SEL.NO.). Replace the retaining hook (if necessary).

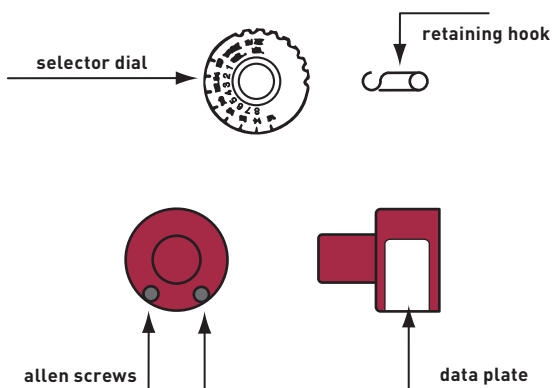

## 3. Crimping instructions

- 1 Insert the contact and the prepared \* conductor through the opening of the indenter in the turret positioner.
- 2 Tighten the crimping tool handle until the stop gear is released. The tool will return to the open position.
- 3 Check the position of the crimping on the contact crimping foot. Ideally, the crimping should be between the inspection hole and the top edge of the crimping foot.  
The head of the contact should not be squared and the inspection hole should be intact.

\* i.e. stripped at the correct length and with strands lightly twisted to recover regular lay of strands

## 4. Removing the CXPT 40 positioner

With the crimping tool in the open position, to disassemble the turret, loosen the socket head screws using the 3,5 mm Allen wrench (supplied with the kit).

After the threads are released from the support ring, pull off the positioner with a straight movement.

## 5. Instructions to check calibration

The operations to check the crimping tool must be carried out with the selector dial in position 4 and with the CXPNP gauge (formerly Daniels G425, now Daniels G436 or G1004 which are equivalent for the purpose).

**ATTENTION! Do not crimp the gauge.**

### 5.1 Calibration check

Put the crimping tool in the completely closed position.

“GO” - Insert the end (green) of the gauge as shown (Fig. 1).

The gauge must pass freely between the indenter tips.

“NO GO” - Insert the end (red) of the gauge as shown (Fig. 2).

The gauge should not pass through the opening.

Gauge	tool selector pos. No.	Ø A ± 0,00254 mm (GO) green	Ø B ± 0,00254 mm (NO GO) red
CXPNP	4	1,549 (mm)	1,676 (mm)
		0,0609 (IN)	0,0659 (IN)

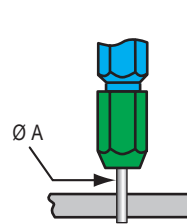

Fig. 1

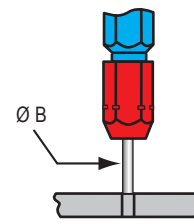

Fig. 2

## 6. Crimping tool maintenance

No maintenance is required.

However, it is good practice to keep the indenter tips free from residual deposits of the coloured band (some types of crimp contacts as per MIL standards are identified by coloured bands in the crimping area) and any other debris.

A metal brush may be used for this purpose.

The following is strongly recommended:

- 1 DO NOT immerse the tools in a solution to clean them.
- 2 DO NOT brush oil in the tools to lubricate them.
- 3 DO NOT try to disassemble the tool or repair it.

This is a high-precision manual crimping tool and must be used as such.



# Tools and accessories for crimp contacts

for contacts of inserts series:		page:
CD	(10A)	66 - 74
CDD	(10A)	76 - 83
CDC	(16A)	104 - 106
CCE	(16A)	130 - 135
CQE	(16A)	168 - 173
CQEE	(16A)	176 - 177
CMCE	(16A)	137 - 145
CQ	(10A/16A)	186 - 193
CX 8/24	(16A/10A)	194
CX 6/36	(40A/10A)	198
CX 12/2	(40A/10A)	199
CX 6/6 *	(16A)	206
MIXO	(40A/16A/10A)	237 - 276

\* the underlined polarities indicate those contacts that require the tools shown in this page

## manual crimping tool gauge



## insertion tool - removal tools replacement tip



description	part No.	part No.
crimping tool for <b>10A, 16A and 40A</b> contacts RENNSTEIG model (turret included)	<b>CCPZ RN</b>	
"go / no go" control gauge to verify indenter closure (see note)	<b>CCPNP RN</b>	
insertion tool for insertion of the contacts into the inserts for crimped contacts up to 0.75 mm <sup>2</sup>		<b>CCINA</b>
removal tools for the extraction of contacts from the inserts for <b>10A</b> contacts <sup>1)</sup> for <b>16A</b> contacts <sup>2)</sup> for <b>40A</b> contacts <sup>3)</sup> and cables Ø < 5 mm for <b>40A</b> contacts <sup>4)</sup> and cables Ø < 7,5 mm		<b>CCES CQES CXES CXES-10</b>
replacement tip for CCES removal tool		<b>CCPR RN</b>

- 1) for CQ, CD, CDD, CX inserts (10A auxiliary contacts) and MIXO module (10A)
- 2) for CQ, CQE, CQEE, CCE, CMCE inserts (excluded 16+2), MIXO module (16A), CX6/6 (16A) and CDC. For CMCE (16+2), CX inserts (contacts 16A insert CX 8/24) using a flat 3 mm screwdriver.
- 3) for CX inserts (40A contacts) and MIXO module (40A)
- 4) for MIXO module CX 03 4B and contacts 10 mm<sup>2</sup>.

**Notes:**

**"go / no go" control gauge**

- A tool used to periodically check that the crimping tool meets standard requirements.

**CCPNP RN**

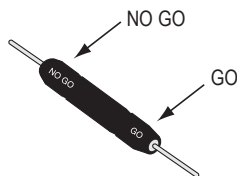

**CCPZ RN**

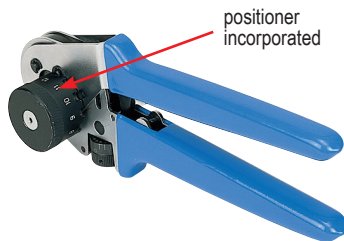

**CCINA**

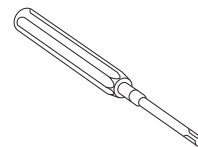

**CCES**

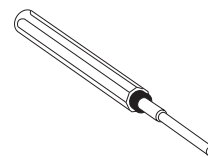

**CCPR RN**

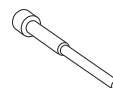

**CQES**

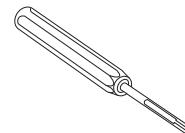

**CXES-10**

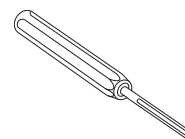

Watch our online tutorial



# Use and maintenance instructions

## 1. General specifications

The **CCPZ RN crimping tool** crimps with 8 pressure points, obtaining similar results to the prescriptions of standard MIL-C-22520/1. The tool has a geared mechanism for controlling the complete crimping cycle, and houses a positioning turret with 12 positions, six of which can be used for positioning the ILME male and female crimping contacts of series CD (10A max), CC (16A max) and CX (40A max).

### 1.1 Crimping range

Conductor cross-sectional area range: from 0,14 mm<sup>2</sup> (26 AWG) to 10 mm<sup>2</sup> (8 AWG).

**Caution!** The handle of the tool must be in the open position when the turret is installed, disassembled or opened. If not, the turret and the crimping tool may be damaged.

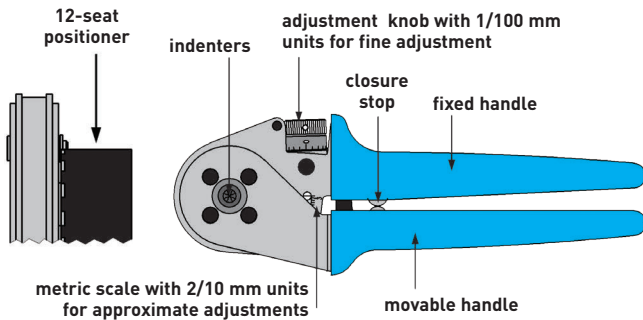

## 2. Description of tool

Crimping tool components: a first mobile handle, with a precision stop mechanism with teeth and an opening limiting guide; a second fixed handle with metric scale (units of 2/10 mm); an adjustment system with fine step adjustments of 1/100 mm; four indenters; a 12-seat positioner, fully rotating through 360° for accurate positioning of contacts. A reference table engraved on the tool surface provides the positioner (POS) number and crimping depth (SET) to select according to the type and size of the ILME contact (the crimping tool can be set to any crimping depth which may be required by the contact manufacturer).

## 3. Adjustment of crimp depth

Crimp depth to be adjusted as follows: the adjustment knob should be turned clockwise to reduce crimping depth, and anti-clockwise to increase it.

### 3.1 Adjustment tolerances:

- 1 scale mark on the knob = adjustment of 1/100 mm (0,01 mm);
- 1 complete rotation of knob = adjustment of 2/10 mm (0,2 mm, this indication can be read on the knob and on the approximate scale);
- 5 knob rotations = adjustment of 1,0 mm (this indication can be read on the scale).

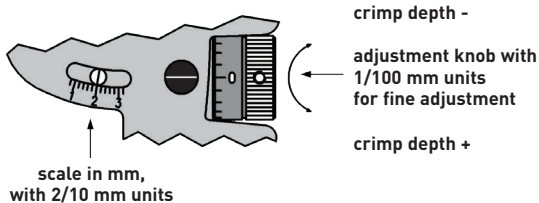

## 4. Crimping instructions

The reference matrix on the crimping tool indicates the correct seat of the positioner (POS M1, F2, M3, F4, M5, F6) to select, and the crimping depth (SET) to adjust for the contact to be crimped.

The contact is inserted through the crimper entry hole on the opposite side of the positioner.

The contact is closed by closing the handles in the first stop position, in order to prevent the contact coming out off the crimper and to facilitate fitting the conductor in the contact.

The precision stop mechanism with teeth ensures consistently precise crimps, by forcing the crimper to close completely and finish the crimping cycle before the crimp can be re-opened.

## Tool adjustment

### Positioner seat = M1 (male) - F2 (female)

CDMA/D (male) CDFA/D (female)	Section (mm <sup>2</sup> )	Crimp depth (mm)
0,3	0,14 0,25 0,37	1,3
0,5	0,5	1,55
0,7	0,75	1,55
1,0	1,0	1,55
1,5	1,5	1,55
2,5	2,5	1,55

### Positioner seat = M3 (male) - F4 (female)

CCMA/D (male) CCFA/D (female)	Section (mm <sup>2</sup> )	Crimp depth (mm)
0,3	0,14	1,2
0,3	0,25-0,37	1,3
0,5	0,5	1,55
0,7	0,75	1,55
1,0	1,0	1,55
1,5	1,5	1,8
2,5	2,5	1,8
3,0	3,0	1,9
4,0	4,0	2,0

### Positioner seat = M5 (male) - F6 (female)

CXMA/D (male) CXFA/D (female)	Section (mm <sup>2</sup> )	Crimp depth (mm)
1,5	1,5	1,55
2,5	2,5	1,8
4,0	4,0	2,0
6,0	6,0	2,5
10,0	10,0	2,3

## 5. Calibration check

The crimping tool is adjusted in the manufacturer's plant. To ensure correct calibration, we advise you to check the tool with a gauge every working day.

This is easily done with the CCPNP RN cylindrical gauge in the 2,0 mm Ø position.

**ATTENTION!** Do not crimp the gauge.

Crimping depth of 2 mm can be adjusted with the adjustment knob (scale marked on "2", screw indicator on "0" as shown in the above figure).

Put the crimping tool in the completely position.

"GO" - Insert the end of the gauge as shown (Fig. 1).

The gauge must pass freely between the indenter tips.

"NO GO" - Insert the end of the gauge as shown (Fig. 2).

The gauge should not pass through the opening.

Gauge	tool selector pos. No.	Ø A	Ø B
		GO	NO GO
CCPNP RN	2	1,94 (mm)	2,06 (mm)

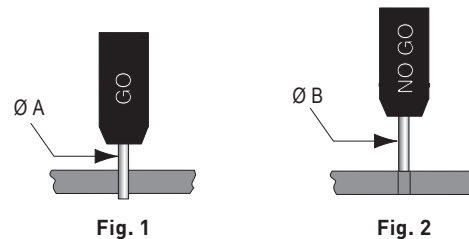

## 6. Maintenance and repair

Keep the crimping tool clean and store it correctly when not in use.

The joints need to be lubricated periodically, and the pin stop circular clips must always stay in position.

This is a high precision crimping tool and must be used as such.

# Tools and accessories for crimp contacts

for contacts of inserts series:

- MIXO (CI contacts, 25 poles)
- MIXO Gigabit (CI contacts, 8 poles)
- MIXO (CI contacts, 8 poles)

page:

- 254 - 255
- 256
- 263

manual crimping tool  
positioner - gauge



**N.B.:**  
CITP D positioner  
(to be ordered separately)

insertion / removal tool



description

part No.

part No.

crimping tool for **CI** contacts  
DANIELS AFM8 model (**positioner excluded**)  
positioner (DANIELS K1450I)  
for **CI** contacts (CIFD and CIMD series)

CIPZ D

CITP D

"go / no go" control gauge (DANIELS G125)  
to verify indenter closure (see note)

CCPNP

insertion tool:

for insertion of the contacts into the inserts, and  
removal tool:

for the extraction of contacts from the inserts  
for **CI** contacts 0,2 - 0,5 mm<sup>2</sup> (CIFD and CIMD series)  
for **CI** contacts 0,75 mm<sup>2</sup> (CIFD and CIMD series)

CIES  
CIES B

**Notes:**

**"go / no go" control gauge**

conforms with international standard MIL-C-22520/3  
- A tool used to periodically check that the crimping tool  
meets standard requirements.

**CIFD - CIMD**

WIRE	mm <sup>2</sup>	0,08-0,75
WIRE	AWG	28 - 18
SEL	NO.	7

**CITP D**

CCPNP

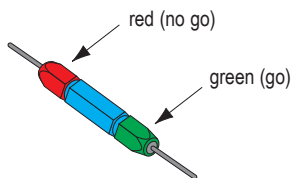

Watch  
our  
online  
tutorial

# Tools and accessories for crimp contacts

for contacts of inserts series:

MIXO (D-SUB)

page:

266

manual crimping tool  
positioner - gauge



**N.B.:**  
**CIVTP D** positioner  
(to be ordered separately)

insertion / removal tool



description	part No.	part No.
-------------	----------	----------

crimping tool  
for **5A** D-SUB contacts (CIVFD and CIVMD series)  
DANIELS AFM8 model (**positioner excluded**)

**CIPZ D**

positioner (DANIELS K761)  
for **5A** D-SUB contacts (CIVFD and CIVMD series)

**CIVTP D**

"go / no go" control gauge (DANIELS G125)  
to verify indenter closure (see note)

**CCPNP**

insertion tool:  
for insertion of the contacts into the inserts, and  
removal tool:  
for the extraction of contacts from the inserts  
for **5A** D-SUB contacts (CIVFD and CIVMD series)

**CIVES**

**Notes:**

**"go / no go" control gauge**

conforms with international standard MIL-C-22520/3  
- A tool used to periodically check that the crimping tool  
meets standard requirements.

**CCPNP**

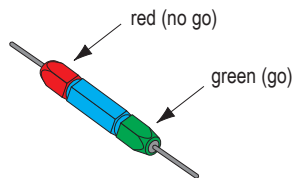

**CIVFD - CIVMD**

mm <sup>2</sup>	0,08	0,13	0,20	0,32	0,52	0,82
AWG	28	26	24	22	20	18
SEL	6	6	5	6	6	6

**CIVTP D**



Watch  
our  
online  
tutorial

# Use and maintenance instructions

## 1. General specifications

The **CIPZ D crimping tool** (Daniels designation AFM8) conforms to the U.S. Military Standard **MIL-C-22520/2C** (designation M22520/2-01) <sup>(1)</sup>. Crimping is performed with 8 pressure points and the tool is equipped with a geared mechanism to control the complete crimping cycle.

The tool must be equipped with an interchangeable positioner (CITP D or CIVTP D) according to the series of contacts to be crimped.

<sup>(1)</sup> Since October 2011 the MIL-C-22520 series is being progressively replaced by a corresponding **SAE** <sup>(1)</sup> **AS22520** series. The military series will be fully cancelled once all SAE parts will be published. SAE International, so named since 2006 and established in 1905 as the *Society of Automotive Engineers*, is a U.S.-based, globally active professional association and standards developing organization working in various industries, having as core business the transport industries such as automotive, aerospace, and commercial vehicles.

## 2. Crimping range

Conductor cross-sectional area range: from 0,08 mm<sup>2</sup> (28 AWG) to 0,52 mm<sup>2</sup> (20 AWG).

### Caution!

The handle of the tool must be in the open position when the positioner is installed, disassembled or opened. If not, the positioner and the crimping tool may be damaged.

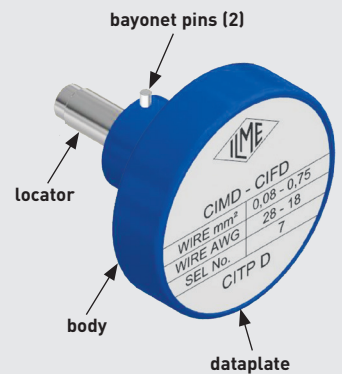
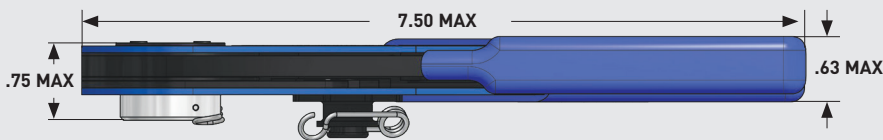
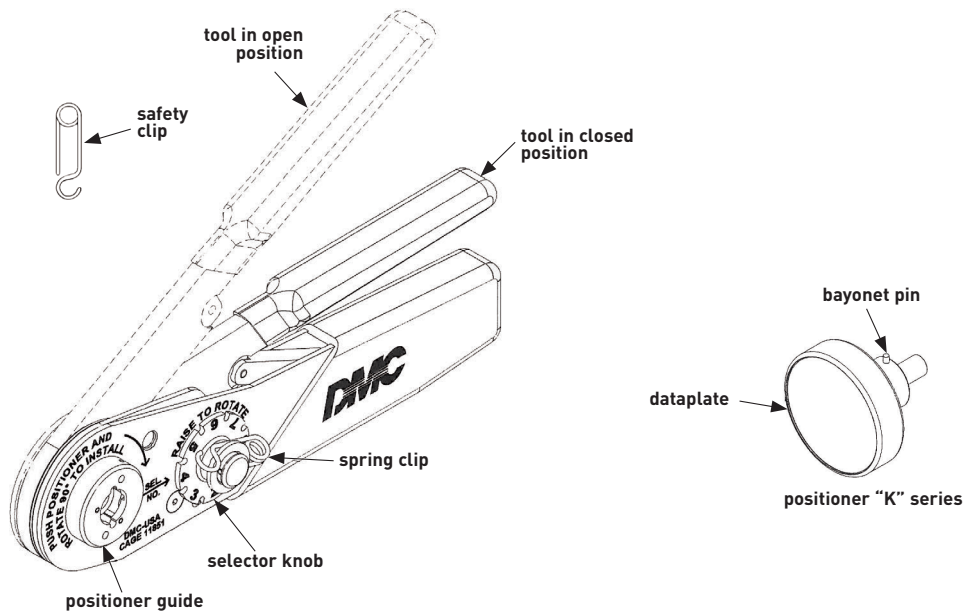

<b>ILME</b>	
CIMD - CIFD	
WIRE mm <sup>2</sup>	0,08 - 0,75
WIRE AWG	28 - 18
SEL No.	7
CITP D	

CITP D positioner

### 3. CITP D or CIVTP D positioner installation

- 1 The crimping tool must be in the open position.
- 2 Remove the safety clip from the positioner guide.
- 3 Insert the previously selected **CITP D** or **CIVTP D** positioner into the positioner guide on the head of the tool. Push down and rotate 90 degrees until bayonet pins lock.
- 4 Refer to the data plate on the **CITP D** or **CIVTP D** positioner for the setup of the selector number that determines crimp height, based on the contact size and conductor size.
- 5 With the tool in open position, remove the spring clip then raise and rotate selector knob until number indicated on data plate for conductor size to be crimped is in line with SEL. NO. arrow. Reinstall spring clip to avoid unintended change of setup

### 4. Crimping instructions

- 1 Insert the contact and the prepared (correctly stripped) conductor through the indenter opening in the positioner.
- 2 Squeeze the crimping tool handles together until ratchet releases. Handles will return to open position.
- 3 Check the position of the crimping on the contact crimp barrel. Ideally, the crimping should be between the inspection hole and the top edge of the crimp barrel.

The edge of the contact barrel should not result squared and the inspection hole should remain intact.

### 5. Removing the CITP or CIVTP positioner

With the crimping tool in the open position, to disassemble the positioner, push down on the positioner to release the bayonet pins from the positioner guide. Turn 90 degrees anticlockwise and remove the positioner from the tool.

### 6. Instructions to check calibration

The operations to check the crimping tool must be carried out with the selector dial in position 8 and the CCPNP gauge.

**CAUTION! Do not crimp gauge!**

#### 6.1 Calibration check

Put the crimping tool in the completely closed position.

“GO” - Insert the end (green) of the gauge as shown (Fig. 1).

The gauge must pass freely between the indenter tips.

“NO GO” - Insert the end (red) of the gauge as shown (Fig. 2).

The gauge should not pass through the opening.

Gauge	tool selector pos. No.	$\varnothing A \pm 0,00254$ mm (GO) green	$\varnothing B \pm 0,00254$ mm (NO GO) red
CCPNP	8	0,991 (mm)	1,118 (mm)
		0,0390 (IN)	0,0440 (IN)

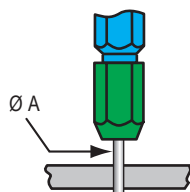

Fig. 1

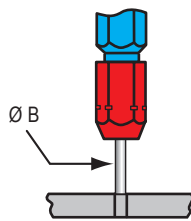

Fig. 2

### 7. Crimping tool maintenance

No maintenance is required. However, it is good practice to keep the indenter tips free from residual deposits of the coloured band (some types of crimp contacts as per SAE (MIL) standards are identified by coloured bands in the crimping area) and any other debris. A small wire brush may be used for this purpose.

The following is strongly recommended:

- 1 DO NOT immerse the tools in a solution to clean them.
- 2 DO NOT brush oil in the tools to lubricate them.
- 3 DO NOT try to disassemble the tool or repair it.

This is a high-precision manual crimping tool and must be used as such.

## Tools and accessories for crimp contacts

for contacts of inserts series:

page:

**CX 6/6** (100A)  
**MIXO** (200A/100A/70A)

**206**  
**232 - 236**

manual crimping tool  
crimping dies



removal tool



description	part No.	part No.
crimping tool for <b>70A/100A/200A</b> series contacts basic tool mod. CEMBRE HT 45 excluding crimping dies and locators	<b>CPPZ C *</b>	
crimping dies for CX7 contacts with 10 mm <sup>2</sup> (AWG 8 - 7) section for CX7 contacts with 16 mm <sup>2</sup> (AWG 6 - 5) section for CX7 contacts with 25 mm <sup>2</sup> (AWG 4 - 3) section	<b>CGD 10 C</b> <b>CGD 16 C</b> <b>CGD 25 C</b>	
crimping dies for CG contacts with 10 mm <sup>2</sup> (AWG 8 - 7) section for CG contacts with 16 mm <sup>2</sup> (AWG 6 - 5) section for CG contacts with 25 mm <sup>2</sup> (AWG 4 - 3) section for CG contacts with 35 mm <sup>2</sup> (AWG 2) section	<b>CGD 10 C</b> <b>CGD 16 C</b> <b>CGD 25 C</b> <b>CGD 35 C</b>	
crimping dies for CY contacts section 16 mm <sup>2</sup> (AWG 6) for CY contacts section 25 mm <sup>2</sup> (AWG 4) and section 35 mm <sup>2</sup> (AWG 2) for CY contacts section 50 mm <sup>2</sup> (AWG 1) for CY contacts section 70 mm <sup>2</sup> (AWG 2/0)	<b>CGD 25 C</b> <b>CYD 35 C</b>  <b>CYD 50 C</b> <b>CYD 70 C</b>	
locator for CX7 contacts for CG contacts for CY contacts	<b>CX7PZ LOC</b> <b>CGPZ LOC</b> <b>CYPZ LOC</b>	
removal tool for 70A CX7 series contact		<b>C7ES</b>

**NOTE:**  
For **CGMA 35** and **CGFA 35** contacts, and their corresponding **CGD 35 C** matrix pair, the contact may be inserted even after closing the head.

\* Part No. **CPPZ CF:**  
Manual crimping tool carrying case (CGPZ VLG) complete with crimping dies (CGD/CYD), locator (CX7PZ LOC, CGPZ LOC, CYPZ LOC) and removal tool (C7ES).

part No.	punching	contacts	mm <sup>2</sup>	AWG min (mm <sup>2</sup> )	AWG max (mm <sup>2</sup> )
<b>CGD 10 C</b>	ME 2	<b>CX7MA 10, CX7FA 10</b> <b>CGT 6.0, CGT 10</b>	10	8 (8,4)	7 (10,6)
<b>CGD 16 C</b>	ME 3	<b>CX7MA 16, CX7FA 16</b>	16	6 (13,3)	5 (16,8)
<b>CGD 25 C</b>	ME 5	<b>CX7MA 25, CX7FA 25</b>	25	4 (21,2)	3 (26,7)
<b>CGD 10 C</b>	ME 2	<b>CGMA 10, CGFA 10</b>	10	8 (8,4)	7 (10,6)
<b>CGD 16 C</b>	ME 3	<b>CGMA 16, CGFA 16</b> <b>CGT 16</b>	16	6 (13,3)	5 (16,8)
<b>CGD 25 C</b>	ME 5	<b>CGMA 25, CGFA 25</b>	25	4 (21,2)	3 (26,7)
<b>CGD 35 C</b>	ME 7	<b>CGMA 35, CGFA 35</b> <b>CGT 24</b>	35	-	2 (33,6)
<b>CGD 25 C</b>	ME 5	<b>CYMA 16, CYFA 16</b>	16	6 (13,3)	
<b>CYD 35 C</b>	ME 9	<b>CYMA 25, CYFA 25</b> <b>CYMA 35, CYFA 35</b>	25 35	4 (21,2) 2 (33,6)	
<b>CYD 50 C</b>	ME 12	<b>CYMA 50, CYFA 50</b>	50	1 (42,4)	
<b>CYD 70 C</b>	ME 17	<b>CYMA 70, CYFA 70</b>	70	2/0 (67,4)	



Watch our online tutorial



# Use and maintenance instructions

## General specifications

The **CPPZ C crimping tool** are a hydraulically operated tool suitable for manually crimping contact series (70A/100A/200A max) removable crimp contacts which may be used in MIXO series type **CX7, CG, CY** and **CGT** adaptors. By using a suitable, hexagonal footprint crimp matrix pair, these pliers allow crimped connections to be made which conform to the highest quality standards.

The main features of these pliers are listed below:

- Scope of application: suitable for crimping wire terminals for up to 150 mm<sup>2</sup> flexible copper wires.
- Force developed: 50 kN (6 tons)
- Nominal operating pressure: 600 bar (8.600 psi)
- Dimensions: length 346 mm (13,6")
  - width (locked moving handle) 130 mm (5,1")
  - width (free moving handle) 250 mm (9,8")
- Weight: (without matrixes and without ILME locator) 2,0 kg (4,4 lbs)
- Recommended oil: AGIP ARNICA 32 or SHELL TELLUS OIL TX 32 or equivalent
- Other features: please read the user and maintenance manual supplied with the tool.

The pliers are equipped with a locator specifically designed for ILME crimp contacts to be mounted on the moving part of the pliers head by means of the Allen screw provided.

**NOTE:** It is possible to use the CPPZ C pliers with the CX7 70A, CG 100A and CY 200A contact series, by simply fitting the CX7PZ LOC, CGPZ LOC or CYPZ LOC locator and crimping matrixes to be purchased separately.

**WARNING:** For crimping the CGT adaptors, the crimp locating operation must be carried out by the user.

## User instructions

### 1) Preliminary operations

According to requirements, the pliers can be fitted with one or more pairs of crimp matrixes selected from the matrixes listed in the catalogue, to crimp the contacts shown in the table page 720.

**NOTE:** The crimp contacts are only suitable for crimping flexible copper wires featuring a nominal section shown in the table with the crimp matrixes shown in the table. Any contacts – wires – matrixes combination which does not conform to these instructions is not physically possible (ex: using 35 mm<sup>2</sup> contacts with CGD 25 C matrixes is not possible because the pliers head would not close) or produces non conforming crimped connections or not usable in the MIXO series.

Open the tool head by moving the matrix supporting hook (22) outwards until the matrix support (21) is released.

With reference to **Figures 1 and 2**, select a pair of matrixes suitable to the type of contact and insert them in the housings: one in the matrix support (21), the other one in the matrix pusher support (26). (NB: the two matrixes of each pair are the same).

Insert the contact by resting it in the locator with the tip forward, then close the head.

The contact crimp housing will be accessible in the mouth between the matrixes.

Remove the moving handle (36) by removing the handle locking belt from the handle.

Before carrying out the next operations, make sure the head is fully closed to avoid damages.

The pliers head can rotate by 180° in relation to the body, thus allowing the operator to work in the most comfortable position.

**WARNING: do not force the head by trying to rotate it when the tool is under pressure.**

### 2) Approaching the matrixes

If possible closing the dies, rest the pliers head on a work top, then move the moving handle to start moving the matrixes closer to the contact, then carry on moving them until the contact is locked between the matrixes.

Push the correctly stripped and suitable long (15 mm) wire all the way in the contact (or the CGT adaptors) crimp housing by carefully checking that the braids are fully compacted, are not damaged and, above all, are all fully inserted. Correctly pushing the contact in the locator ensures that the matrixes are exactly in the right area to compress (the contact crimp shaft centre). Make sure that the locator is free from any residue which would alter

the position of the contact. For crimping the CGT 16 earth adaptor, manually locate the area to be crimped between the matrixes. If necessary, re-open the matrixes by following the instructions described in paragraph 4 and reposition the contact.

### 3) Crimping

Continue to operate the moving handle (pumping): the piston will gradually move forward until the matrixes come into contact.

Continue the pumping action until the maximum pressure valve clicks in.

### 4) Releasing the dies

Fully press the pressure release lever (50) located on the pliers pumping body until the piston goes back and the matrixes open.

To remove the crimped contact, re-open the pliers head.

### 4) Storage

Fully return the piston as described in paragraph 4, then lock the moving handle in position by using the belt provided.

## Cleaning and maintenance

The tool is very sturdy and does not require any special care; a correct operation is ensured by following a few simple precautions.

The tool is supplied with a user and maintenance manual, which gives all detailed instructions. Read this manual before use.

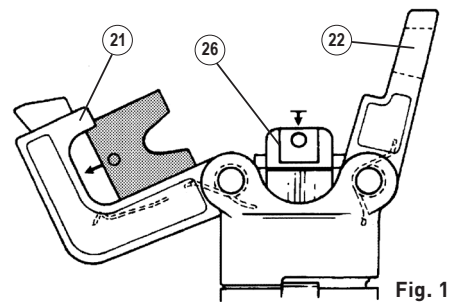

Fig. 1

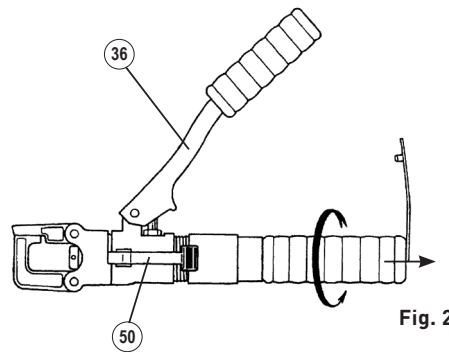

Fig. 2

## CGPZ VLG carrying case



- for CPPZ C \* crimping tool
- dimensions 445 x 290 x h 95 mm
- weight 1,2 kg
- houses 20 pairs of matrixes

\* to store the CPPZ C crimping tool inside the carrying case, turn the pliers head by 180° so that the locator becomes visible.



# Tools and accessories for crimp contacts

for contacts of inserts series:		page:
CD	(10A)	66 - 74
CDD	(10A)	76 - 83
CDC	(16A)	104 - 106
CCE	(16A)	130 - 135
CMCE	(16A)	137 - 145
CQE	(16A)	168 - 173
CQEE	(16A)	176 - 177
CQ	(10A/16A)	186 - 193
CX 8/24	(16A/10A)	194
CX 6/36 *	(10A)	198
CX 12/2 *	(10A)	199
CX 6/6 *	(16A)	206
MIXO	(10A/16A)	241 - 276

\* the underlined polarities indicate those contacts that require the tools shown in this page

## pneumatic crimping tool positioner - gauge



## insertion tool - removal tools replacement tip



description	part No.	part No.
pneumatic crimping tool for <b>10A</b> and <b>16A</b> contacts model DANIELS WA27F (turret excluded)	<b>CCPZP</b>	
positioner (see note) for <b>10A</b> contacts (CDF and CDM series)	<b>CCTP 10</b>	
for <b>16A</b> contacts (CCF and CCM series)	<b>CCTP 16</b>	
bench support for CCPZP pneumatic crimping tool (DANIELS BM-2A)	<b>CCSPZP</b>	
pneumatic foot valve (DANIELS WA10A)	<b>CCVPP</b>	
"go / no go" control gauge to verify indenter closure (see note)	<b>CCPNP</b>	
insertion tool for insertion of the contacts into the inserts for crimped contacts up to 0,75 mm <sup>2</sup>		<b>CCINA</b>
removal tools for the extraction of contacts from the inserts for <b>10A</b> contacts <sup>1)</sup>		<b>CCES</b>
for <b>16A</b> contacts <sup>2)</sup>		<b>CQES</b>
replacement tip for CCES removal tool		<b>CCPR RN</b>

- 1) for CQ, CD, CDD, CX inserts (10A auxiliary contacts) and MIXO module (10A)
- 2) for CQ, CQE, CQEE, CCE, CMCE inserts (excluded 16+2), MIXO module (16A), CX6/6 (16A) and CDC. For CMCE (16+2), CX inserts (contacts 16A insert CX 8/24) using a flat 3 mm screwdriver.

### Notes:

#### Positioner

conforms to international standard MIL-C-22520/1  
- An interchangeable and indispensable accessory of the CCPZP crimping tool, it precisely positions the contact where crimping is performed. Each series of contacts requires its own turret.

#### "go / no go" control gauge

conforms with international standard MIL-C-22520/3  
- A tool used to periodically check that the crimping tool meets standard requirements.

#### CCPNP

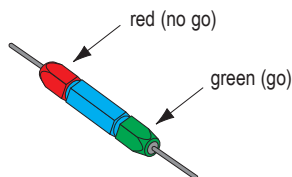

#### CCPZP

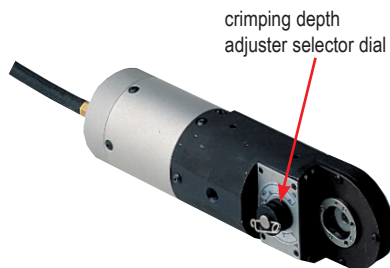

#### CCTP

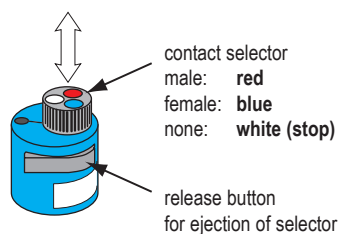

#### CCINA

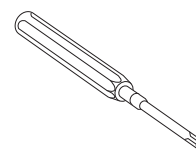

#### CCES

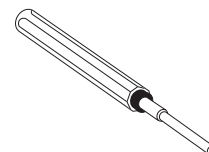

#### CCPR RN

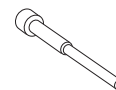

#### CQES

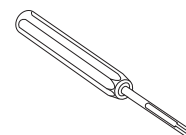

Watch our online tutorial

# Use and maintenance instructions

## 1. General specifications

This is the pneumatic version of the **DANIELS AF8 crimping tool** (CCPZ MIL). Crimping is performed with 8 pressure points. The tool is equipped with a geared mechanism to control the complete crimping cycle.

**The tool must be equipped with an interchangeable turret (CCTP) according to the series of contacts to be crimped.**

It is possible to use a hand valve (located on the crimping tool) or a foot valve (optional). The tool operating pressure is 5,5 - 8,3 bar. It is recommended to utilise an adjustment and air filtering unit.

### 1.1 Crimping range

Conductor cross-sectional area range: from 0,14 mm<sup>2</sup> (26 AWG) to 4 mm<sup>2</sup> (12 AWG).

### 1.2 Operation with pneumatic foot valve (optional)

Connect the foot valve between the compressed air source and the tool air inlet. Lower the hand valve on the tool and stop it in the lowered position with the stop screw (A) using a 1,5 mm Allen wrench.

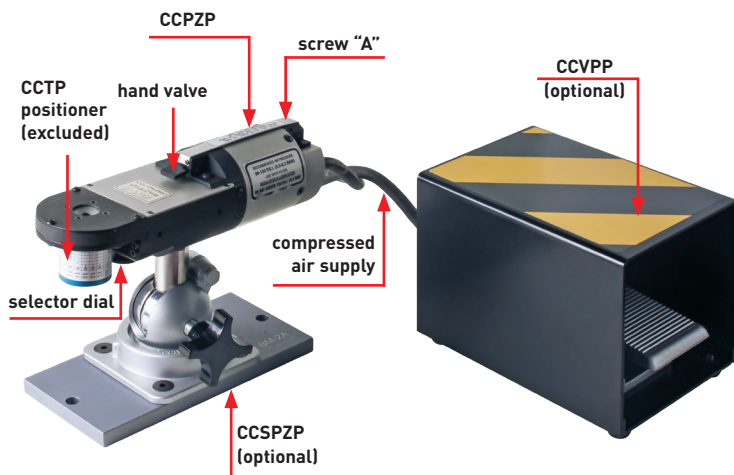

## 2. Checking the crimping complete cycle control mechanism

Correct operation can be checked based on the following procedure:

- 1 Install a CCTP turret (see 3).
- 2 Reduce the pressure to 1 bar.
- 3 Using a contact that corresponds to the installed turret, with size 0,5, and a wire with section 0,5 mm<sup>2</sup>, use the crimping tool, referring to the crimping instructions. The indenters will not reach the fully closed position and the contact will be internally blocked if the geared mechanism is operating correctly.
- 4 To release the partially crimped contact, increase the air pressure of the line to 5,5 - 8,3 bar and again use the crimping tool. It will then complete the crimping, allowing the indenters to return to the fully open position.

## 3. CCTP positioner installation (Fig. A)

- 1 Position the previously selected CCTP positioner on the support ring located on the crimping tool (matching the special pin on the base of the turret with the corresponding hole on the support ring), aligning the tapped holes with the socket head screws.
- 2 With the CCTP positioner positioned against the support ring, tighten the socket head screws with the 3,5 mm Allen wrench (supplied with the kit).
- 3 Refer to the data plate on the CCTP positioner. From the colour code column, select the colour of the positioner that corresponds to the appropriate code and dimension of the contact to be crimped.
- 4 With the CCTP positioner in the adjustment position, turn the turret selector until the colour-coded positioner is aligned with the indicator line. Press the turret until it clicks into the connected position.
- 5 Refer to the data plate on the CCTP positioner. From the column indicating the proper conductor section, determine the number that corresponds to the contact being used.
- 6 Remove the retaining hook from the crimping tool selector dial. Lift the selector dial and turn it until the selector number is aligned with the indicator (SEL.NO.). Replace the retaining hook (if necessary).

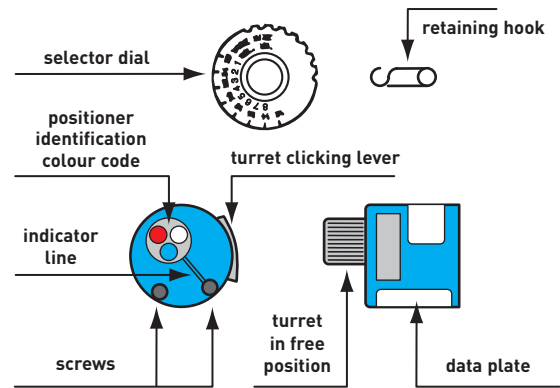

Fig. A

## 4. Crimping instructions

- 1 Insert the contact and the prepared conductor through the opening of the indenter in the turret positioner.
- 2 Activate the hand valve or the optional foot valve. Once crimping has been completed, the tool will return to the open position.
- 3 Check the position of the crimping on the contact crimping foot. Ideally, the crimping should be between the inspection hole and the top edge of the crimping foot. The head of the contact should not be squared and the inspection hole should be intact.

## 5. Releasing a partially crimped contact

To release a partially crimped contact, do the following:

- 1 Increase the air pressure to 8,5 bar and use the crimping tool. If the increase in air pressure does not release the contact, do the following.
- 2 Turn the selector dial clockwise to the highest lockable setting (the selector dial must be in the blocked position before continuing). Use the crimping tool.
- 3 If it does not release after several attempts, contact the ILME offices.

## 6. Removing the CCTP positioner

With the crimping tool in the open position, to disassemble the turret, loosen the socket head screws using the 3,5 mm Allen wrench (supplied with the kit). After the threads are released from the support ring, pull off the turret with a straight movement.

## 7. Instructions to check calibration

The operations to check the crimping tool must be carried out with the selector dial in position 4 and the CCPNP gauge.

**ATTENTION! Do not crimp the gauge.**

### 7.1 Calibration check

Put the crimping tool in the completely closed position.

“GO” - Insert the end (green) of the gauge as shown (Fig. 1).

The gauge must pass freely between the indenter tips.

“NO GO” - Insert the end (red) of the gauge as shown (Fig. 2).

The gauge should not pass through the opening.

Gauge	tool selector pos. No.	Ø A ± 0,00254 mm (GO) green	Ø B ± 0,00254 mm (NO GO) red
CCPNP	4	0,991 (mm) 0,0390 (IN)	1,118 (mm) 0,0440 (IN)

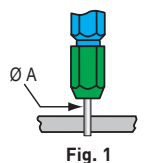

Fig. 1

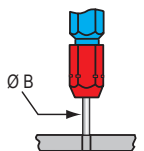

Fig. 2

## 8. Crimping tool maintenance

No maintenance is required.

However, it is good practice to keep the indenter tips free from residual deposits of the coloured band (some types of crimp contacts as per MIL standards are identified by coloured bands in the crimping area) and any other debris. A metal brush may be used for this purpose.

The following is strongly recommended:

- 1 DO NOT immerse the tools in a solution to clean them.
- 2 DO NOT brush oil in the tools to lubricate them.
- 3 DO NOT try to disassemble the tool or repair it.

This is a high-precision manual crimping tool and must be used as such.

# Tools and accessories for crimp contacts

for contacts of inserts series:		page:
CD	(10A)	66 - 74
CDD	(10A)	76 - 83
CDC	(16A)	104 - 106
CCE	(16A)	130 - 135
CMCE	(16A)	137 - 145
CQE	(16A)	168 - 173
CQEE	(16A)	176 - 177
CQ	(10A/16A)	186 - 193
CX 8/24	(16A/10A)	194
CX 6/36 *	(10A)	198
CX 12/2 *	(10A)	199
CX 6/6 *	(16A)	206
MIXO	(10A/16A)	241 - 276

\* the underlined polarities indicate those contacts that require the tools shown in this page

## pneumatic crimping tool with automatic positioner - inserts - gauge



## insertion tool - removal tools replacement tip



description	part No.	part No.
crimping tool with automatic positioner model DANIELS WA27FAP (inserts excluded)	<b>CCPZPA</b>	
positioner inserts (see note) male contacts <b>10A</b> (CDM series) female contacts <b>10A</b> (CDF series) male contacts <b>16A</b> (CCM series) female contacts <b>16A</b> (CCF series)	<b>CCTPADM</b> <b>CCTPADF</b> <b>CCTPACM</b> <b>CCTPACF</b>	
"go / no go" control gauge to verify indenter closure (see note)	<b>CCPNP</b>	
insertion tool for insertion of the contacts into the inserts for crimped contacts up to 0,75 mm <sup>2</sup>		<b>CCINA</b>
removal tools for the extraction of contacts from the inserts for <b>10A</b> contacts <sup>1)</sup> for <b>16A</b> contacts <sup>2)</sup>		<b>CCES</b> <b>CQES</b>
replacement tip for CCES removal tool		<b>CCPR RN</b>

- 1) for CQ, CD, CDD, CX inserts (10A auxiliary contacts) and MIXO module (10A)
- 2) for CQ, CQE, CQEE, CCE, CMCE inserts (excluded 16+2), MIXO module (16A), CX6/6 (16A) and CDC. For CMCE (16+2), CX inserts (contacts 16A insert CX 8/24) using a flat 3 mm screwdriver.

**Notes:**

**Positioner inserts**

- Interchangeable and indispensable accessories of the CCPZPA crimping tool precisely position the contact where crimping is performed. Each contact requires its own positioner insert selected according to the type of contact (10A or 16A) and the kind (male or female).

**CCTPADM and CCTPADF**  
**CCTPACM and CCTPACF**

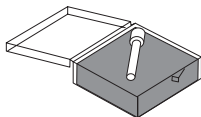

**"go / no go" control gauge**

conforms with international standard MIL-C-22520/3  
- A tool used to periodically check that the crimping tool meets standard requirements.

**CCPNP**

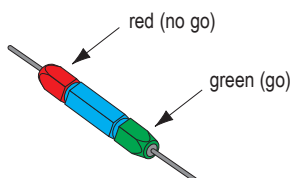

**CCPZPA**

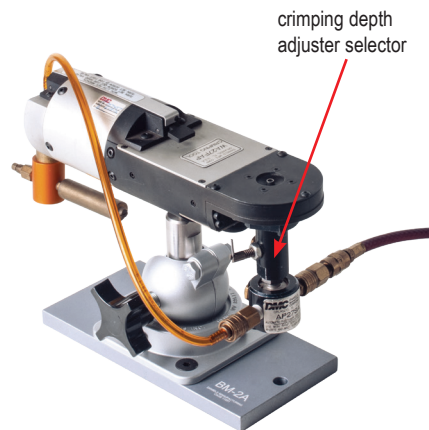

**CCINA**

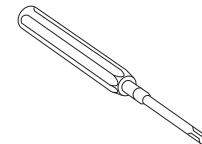

**CCES**

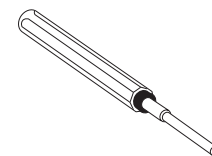

**CCPR RN**

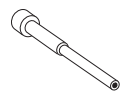

**CQES**

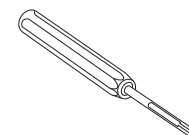

# Use and maintenance instructions

## 1. General specifications

This is the pneumatic version of the manual crimping tool. Crimping is performed with 8 pressure points. The tool is equipped with a geared mechanism to control the complete crimping cycle. Thanks to the automatic positioner it is possible to crimp simply by inserting the uncrimped contact + wire into the tool crimping cavity.

**It is also necessary to order the interchangeable positioner inserts relative to the series of contacts to be crimped.**

The tool operating pressure is 5,5 - 8,3 bar. It is recommended to utilise an adjustment and air filtering unit.

### 1.1 Crimping range

Conductor cross-sectional area range: from 0,12 mm<sup>2</sup> (26 AWG) to 4 mm<sup>2</sup> (12 AWG).

**Fig. A**  
(complete crimping tool)

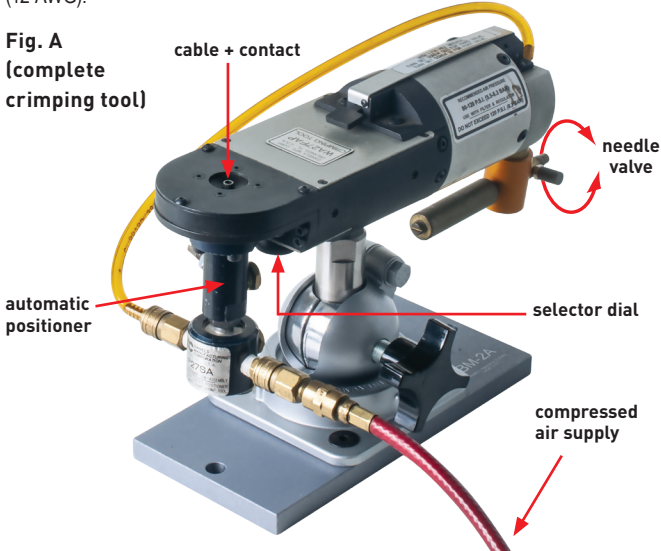

**Fig. B**

(automatic positioner)

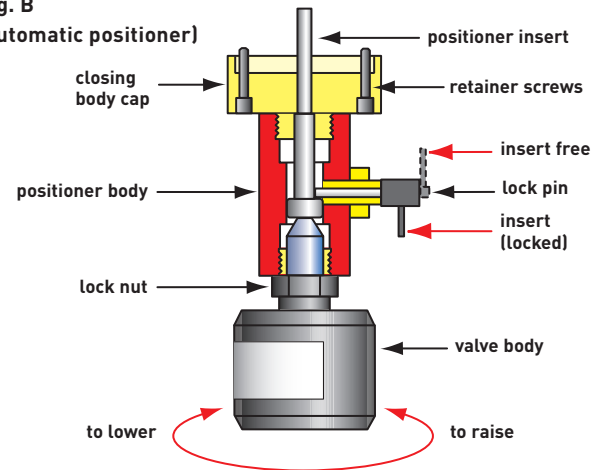

## 5. Crimping instructions

- To obtain the suitable selector number, refer to the data plate located on the cover of the positioner insert case, and adjust the selector dial as specified.
- Insert the contact and the prepared conductor through the opening of the indenter in the crimping tool casing (Fig. A).
- Exert slight pressure until the crimping tool automatically crimps the contact. **CAUTION: Wire sections less than 0,34 mm<sup>2</sup> (24 AWG) up to 0,08 mm<sup>2</sup> (28 AWG) or equivalent are not sufficiently rigid, so that it may be rather difficult to push the contact + wire.**
- Check the position of the crimping on the contact crimping foot. Ideally, the crimping should be between the inspection hole and the top edge of the crimping foot. The head of the contact should not be squared and the inspection hole should be intact.

## 6. Instructions to check calibration

The operations to check the crimping tool must be carried out with the selector dial in position 4 and the CCPNP gauge. **ATTENTION! Do not crimp the gauge.**

### 6.1 Calibration check

- Disconnect the compressed air.
- Push the positioner insert toward the bottom and lock it using the lock pin.
- Reconnect the compressed air.
- Turn the needle valve counterclockwise to open the air supply (Fig. A).
- The indenters will extend and remain in the extracted position until the valve is closed.
- Check using the gauge, referring to the "go / no go" instructions reported below.
- When the calibration check has been completed, close the needle valve turning it clockwise (Fig. A).
- Put the lock pin in the "free" position.
  - "GO" - Insert the end (green) of the gauge as shown (Fig. 1). The gauge must pass freely between the indenter tips.
  - "NO GO" - Insert the end (red) of the gauge as shown (Fig. 2). The gauge should not pass through the opening.

Gauge	tool selector pos. No.	Ø A ± 0,00254 mm (GO) green	Ø B ± 0,00254 mm (NO GO) red
CCPNP	4	0,991 (mm) 0,0390 (IN)	1,118 (mm) 0,0440 (IN)

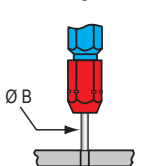
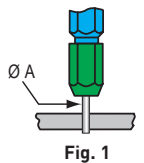

**Fig. 1**

**Fig. 2**

## 7. Crimping tool maintenance

No maintenance is required. However, it is good practice to keep the indenter tips free from residual deposits of the coloured band (some types of crimp contacts as per MIL standards are identified by coloured bands in the crimping area) and any other debris. A metal brush may be used for this purpose. The following is strongly recommended:

- DO NOT immerse the tools in a solution to clean them.
  - DO NOT brush oil in the tools to lubricate them.
  - DO NOT try to disassemble the tool or repair it.
- This is a high-precision crimping tool and must be used as such.

## 2. Installation or replacement of a positioner insert

- Disconnect the workshop compressed air source.
- Disconnect the air hoses from the automatic positioner (rapid connectors).
- Remove the connection screws, using the 3,5 mm Allen wrench (supplied with the kit), to separate the automatic positioner from the crimping tool. The indenters will not reach the fully closed position and the contact will be internally blocked if the geared mechanism is operating correctly.
- Unscrew the positioner closing housing.
- Install or replace the proper positioner insert in the positioner housing, replacing the underlying spring.
- Reverse the operations, as described from point 4 to point 1.

## 3. Crimping position adjustment (Fig. B)

- Release the automatic positioner from the crimping tool body (see points 1 and 2 "Installation replacement of a positioner insert").
- While holding the positioner body in position using a 19 mm wrench, loosen the lock nut with a 14 mm wrench.
- Push the positioner insert toward the bottom and lock it using the lock pin. The indenters will not reach the fully closed position and the contact will be internally blocked if the geared mechanism is operating correctly.
- If the pin doesn't lock, unscrew the valve body toward the bottom.
- With the pin locked, tighten the valve body toward the top until it strikes against the positioner insert.
- While maintaining that position, tighten the lock nut.
- Replace and connect the positioner on the crimping tool.
- Release the lock pin in the "free" position.

## 4. Checking the crimping complete cycle control mechanism

Correct operation can be checked based on the following procedure:

- Reduce the pressure to 1 bar.
- Using a contact that corresponds to the installed positioner, with size 0,5 and a wire with section 0,5 mm<sup>2</sup>, use the crimping tool, referring to the crimping instructions. The indenters will not reach the fully closed position and the contact will be internally blocked if the geared mechanism is operating correctly.
- To release the partially crimped contact, increase the air pressure of the line to 5,5 - 8,3 bar and again use the crimping tool. It will then complete the crimping, allowing the indenters to return to the fully open position. The indenters will not reach the fully closed position and the contact will be internally blocked if the geared mechanism is operating correctly.



# Tools and accessories for crimp contacts

for contacts of inserts series:

page:

<b>CX 6/12 *</b>	(40A)	<b>197</b>
<b>CX 6/36 *</b>	(40A)	<b>198</b>
<b>CX 12/2 *</b>	(40A)	<b>199</b>
<b>MIXO</b>	(40A)	<b>237 - 242</b>

\* the underlined polarities indicate those contacts that require the tools shown in this page

## pneumatic crimping tool positioner – gauge



CCSPZP

CCVPP

## removal tool



description	part No.	part No.
pneumatic crimping tool for <b>40A</b> contacts model DANIELS WA27-309-EP (positioner excluded)	<b>CXPZP D</b>	
positioner (see note) for <b>40A</b> contacts ( <b>CX</b> and <b>RX HNM</b> series)	<b>CXTP 40</b>	
bench support for CXPZP D pneumatic crimping tool (DANIELS BM-2A)	<b>CCSPZP</b>	
pneumatic foot valve (DANIELS WA10A)	<b>CCVPP</b>	
“go / no go” control gauge (DANIELS G1005) to verify indenter closure or wear (see note)	<b>CXPNPP</b>	
removal tool for the extraction of contacts from the inserts for <b>40A</b> contacts		<b>CXES</b>

**Notes:**

**Positioner**

- An interchangeable and indispensable accessory of the CXPZP D pneumatic crimping tool, it precisely positions the contact where crimping is performed. Each series of contacts (male or female) requires its own turret.

**CXTP 40**

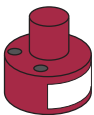

**CXTP 40**

CONTACT	CXMA/CXFA	1.5	2.5	4.0	6.0	10
WIRE SIZE	mm <sup>2</sup>	1,5	2,5	4	6	10
	AWG	16	14	12	10	8
SEL. NO.		5	5	5	7	8
USE WITH		M309				
		WA-27-309-EP				

**“go / no go” control gauge**

- A tool used to periodically check that the crimping tool meets standard requirements.

**CXPNPP**

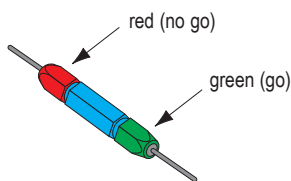

**CXPZP**

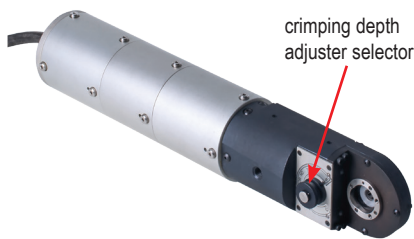

**CXES**

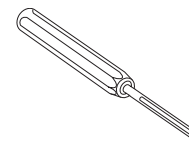

CRIMPING TOOLS

# Use and maintenance instructions

## 1. General specifications

This is the pneumatic version of the CXPZ D hand crimping tool (DANIELS M309). Crimping is performed with 8 pressure points. The tool is equipped with a geared mechanism to control the complete crimping cycle.

**The tool must be equipped with the interchangeable positioner CXTP 40 suitable for series CX (or RX HNM version) crimp contacts.**

The tool comes already equipped with a pneumatic foot pedal valve (WA10A) attached to the tool through 2,7 m (9 ft.) air hose.

The tool operating pressure is 5,5 – 8,3 bar. It is recommended to utilise a lubrication, adjustment and air filtering unit.

### 1.1 Crimping range

Conductor cross-sectional area range: from 0,12 mm<sup>2</sup> (26 AWG) to 10 mm<sup>2</sup> (8 AWG).

### 1.2 Operation with pneumatic foot valve (optional)

Connect the foot valve between the compressed air source and the tool air inlet.

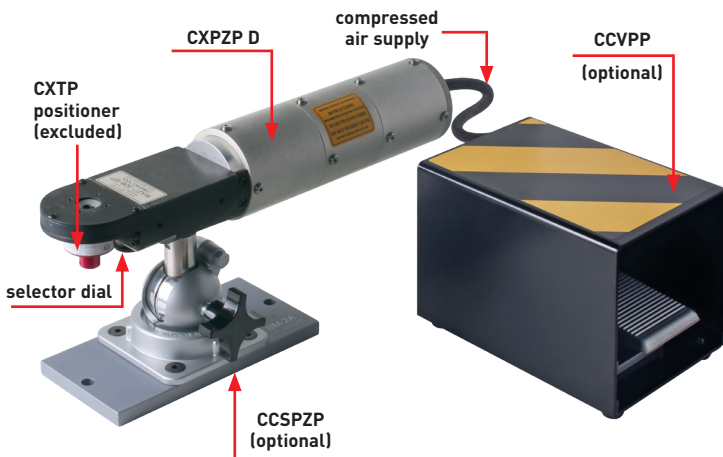

## 2. CXTP 40 positioner installation

- Place the CXTP 40 positioner on the support ring located on the crimping tool (matching the special pin on the base of the turret with the corresponding hole on the support ring), aligning the tapped holes with the socket head screws.
- With the CXTP 40 positioner placed against the support ring, tighten the socket head screws with the 3,5 mm Allen wrench (supplied with the kit).
- Refer to the dataplate on the CXTP 40 positioner. From the column indicating the proper conductor cross-sectional area, determine the number that corresponds to the contact being used.
- Remove the retaining hook from the crimping tool selector dial. Lift the selector dial and turn it until the selector number is aligned with the indicator (SEL. NO.). Replace the retaining hook (if necessary).

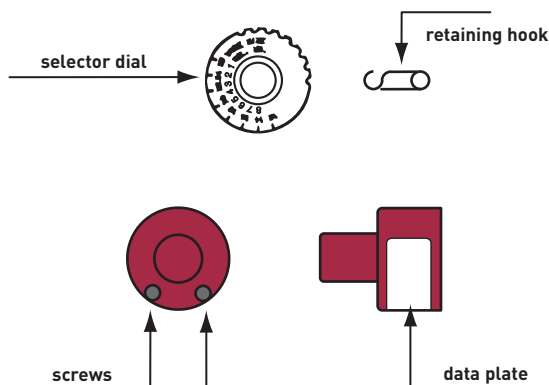

## 3. Checking the crimping complete cycle ratcheting control mechanism

Correct operation can be checked based on the following procedure:

- Install the CXTP 40 positioner (see 2).
- Reduce the pressure to 1 bar.
- Using a series CX contact that corresponds to the installed turret, e.g. size 1.5, and a wire with cross-sectional area 1.5 mm<sup>2</sup> (16 AWG) use the crimping tool, referring to the crimping instructions. The indenters will not reach the fully closed position and the contact will be internally blocked if the geared mechanism is operating correctly.
- To release the partially crimped contact, increase the air pressure of the line to 5,5 – 8,3 bar and again use the crimping tool. It will then complete the crimping, allowing the indenters to return to the fully open position.

## 4. Removing the CXTP 40 positioner

With the crimping tool in the open position, to disassemble the positioner, loosen the socket head screws using the 3,5 mm Allen wrench (supplied with the kit). After the threads are released from the support ring, pull off the positioner with a straight movement.

## 5. Releasing a partially crimped contact

To release a partially crimped contact, do the following:

- Increase the air pressure to 8.5 bar and use the crimping tool. If the increase in air pressure does not release the contact, do the following.
- Turn the selector dial clockwise to the highest lockable setting (the selector dial must be in the blocked position before continuing). Use the crimping tool.
- If it does not release after several attempts, contact the ILME offices.

## 6. Crimping instructions

- Insert the contact and the prepared conductor through the opening of the indenter in the turret positioner.
- Activate the hand valve or the optional foot valve. Once crimping has been completed, the tool will return to the open position.
- Check the position of the crimping on the contact crimping foot. Ideally, the crimping should be between the inspection hole and the top edge of the crimping foot. The head of the contact should not be squared and the inspection hole should be intact.

## 7. Instructions to check calibration

The operations to check the crimping tool must be carried out with the selector dial in **position #5** and the **CXPNPP** gauge (DANIELS G1005 – formerly G425, which is equivalent).

**CAUTION! Do not crimp the gauge.**

### 7.1 Calibration check

Put the crimping tool in the completely closed position.

“GO” - Insert the end (green) of the gauge as shown (Fig. 1). The gauge must pass freely between the indenter tips.

“NO GO” - Insert the end (red) of the gauge as shown (Fig. 2). The gauge should not pass through the opening.

Gauge	tool selector pos. No.	Ø A ± 0,00254 mm (GO) green	Ø B ± 0,00254 mm (NO GO) red
CCPNP	4	0,991 (mm)	1,118 (mm)
		0,0390 (IN)	0,0440 (IN)

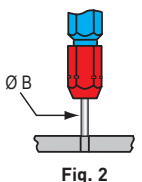
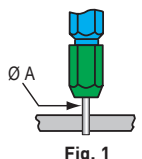

## 8. Crimping tool maintenance

No maintenance is required. However, it is good practice to keep the indenter tips free

from residual deposits of the coloured band (some types of crimp contacts as per MIL standards are identified by coloured bands in the crimping area) and any other debris. A metal brush may be used for this purpose. The following is strongly recommended

- DO NOT immerse the tools in a solution to clean them.
- DO NOT brush oil in the tools to lubricate them.
- DO NOT try to disassemble the tool or repair it.

This is a high-precision crimping tool and must be used as such.

# Tools and accessories for crimp contacts

for contacts of inserts series:		page:
CD	(10A)	66 - 74
CDD	(10A)	76 - 83
CDC	(16A)	104 - 106
CCE	(16A)	130 - 135
CMCE	(16A)	137 - 145
CQE	(16A)	168 - 173
CQEE	(16A)	176 - 177
CQ	(10A/16A)	186 - 193
CX 8/24	(16A/10A)	194
CX 6/36 *	(10A)	198
CX 12/2 *	(10A)	199
CX 6/6 *	(16A)	206
MIXO	(10A/16A)	241 - 276

\* the underlined polarities indicate those contacts that require the tools shown in this page

## stripping and crimping machine



## insertion tool - removal tools replacement tip



description	part No.	part No.
automatic stripping, crimping machine Zoller+Fröhlich AM-03 Universal model	ZFU-CD	
insertion tool for insertion of the contacts into the inserts for crimped contacts up to 0,75 mm <sup>2</sup>		CCINA
removal tools for the extraction of contacts from the inserts for <b>10A</b> contacts <sup>1)</sup> for <b>16A</b> contacts <sup>2)</sup>		CCES CQES
replacement tip for CCES removal tool		CCPR RN

- 1) for CQ, CD, CDD, CX inserts (10A auxiliary contacts) and MIXO module (10A)  
 2) for CQ, CQE, CQEE, CCE, CMCE inserts (excluded 16+2), MIXO module (16A). For CX 6/6 (16A) and CDC. CMCE (16+2), CX inserts (16A contacts CX 8/24 insert) a 3 mm flat screwdriver should be used

### Technical specifications

Drive	electro-pneumatic
Electric feeder	230V/50Hz
Absorbed power	120VA
Fuse (on the system filter module)	2 x 2 A mT
Air operating pressure	5.5 bar
Air consumption	2 nl/cycle
Flexible conductors in conformity with	IEC 60228 class 5
Rated section	0,34-2,5 mm <sup>2</sup> (22 AWG-14 AWG)
Feeding length	52 mm
Contacts	loose, turned
Contact breaker	see list of tools
Feeding	vibrating conveyor
Crimping form	4/8 ratchets
Cycle time	2,5 s - 3 s
Continuous sound level	< 70 dB (A)
Dimensions (l x d x h)	(530 x 500 x 480) mm
Colour	blue, RAL 5012
Weight	40 Kg

### Tools list

contacts	CD... (10A max)						CC... (16A max)					
conductor section (mm <sup>2</sup> )	0,34	0,5	0,75	1,0	1,5	2,5	0,5	0,75	1,0	1,5	2,5	
AWG (approximate)	22	20	18	18	16	14	20	18	18	16	14	
feeding bowl/male	A						B (M)					
feeding bowl/female							B (F)					
feeding tube	A						B					
wire holder	0,34	0,5-1,5				2,5	0,5-1,5 2,5					
starting unit	AB						AB					
stripping blades	V-shaped blades						V-shaped blades					
rear blade spacers												
left/right	0,5 mm / 1,0 mm						0,5 mm / 1,0 mm					
contact holder / pins	A (M)						B					
contact holder / bushes	A (F)											
contact stop	A						B					

### Preset stripping and contact crimping programs

contacts	CD... (10A max)						CC... (16A max)					
conductor section (mm <sup>2</sup> )	0,34	0,5	0,75	1,0	1,5	2,5	0,5	0,75	1,0	1,5	2,5	
AWG (approximate)	22	20	18	18	16	14	20	18	18	16	14	
Program number	1A	2A	3A	4A	5A	6A	7B	8B	9B	10B	11B	
stripping position (mm)	0,75	1,00	1,20	1,30	1,40	1,70	1,00	1,20	1,30	1,40	1,70	
crimping position	1,30	1,35	1,40	1,50	1,55	1,60	1,40	1,40	1,50	1,55	1,70	

### Supplied with the following accessories:

- 1 vibrating conveyor feeder bowl for CD contact series
- 1 vibrating conveyor feeder bowl for male CC contact series
- 1 vibrating conveyor feeder bowl for female CC contact series
- 1 feeder tube (contact passage from vibrating conveyor to machine) for CD contact series
- 1 feeder tube (contact passage from vibrating conveyor to machine) for CC contact series
- 1 contact holder (in crimping position) for male CD contact series
- 1 contact holder (in crimping position) for female CD contact series
- 1 contact holder (in crimping position) for CC contact series
- 1 contact stop for CD contact series
- 1 contact stop for CC contact series
- 1 wire holder for 0,34 mm<sup>2</sup> cables
- 1 wire holder for 0,5 to 1,5 mm<sup>2</sup> cables
- 1 wire holder for 2,5 mm<sup>2</sup> cables
- 1 "GO / NO GO" control gauge
- 1 Allen wrench for setup operations
- 1 set of spacers to regulate the stripping length
- 1 removal tool to extract contacts from the crimping chamber



## General specifications

The **Zoller+Fröhlich AM-03** Universal stripping-crimping machine is a semi-automatic, electro-pneumatically operated bench machine used to quickly and reliably strip flexible copper wires and to crimp loose, turned crimp male and female, **CD** series (10A max) and **CC** series (16A max) contacts in a single run. The contacts are automatically fed by means of a vibro-conveyor unit fitted on the top section of the machine.

The machine carries out the crimping operation with four, eight pressure point indenters, in compliance with the requirements set out in the MIL-C-22520/1 standard.

The stripping depth and crimping depth adjustment is controlled by a software controlled motor. Up to 50 different combinations may be stored and retrieved from the program; these combinations are useful, for example, to meet different requirements related to the wire insulator type and thickness.

The adjustment and programming operations are carried out by using the keypad located on the front panel. The LCD display shows all the functions, the main information and any errors.

The machine is fitted with devices used to check that the crimping cycle has been completed.

The general safety instructions described in the machine user and maintenance manual must be followed and the use of the machine should only be restricted to qualified and trained personnel.

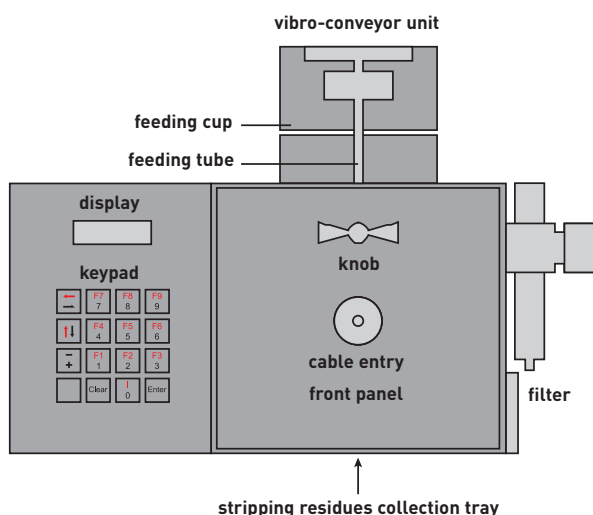

## Crimping range

Wire section: from 0,34 mm<sup>2</sup> (AWG 26) to 2,5 mm<sup>2</sup> (AWG 14).

## Description of the machine

To ensure a correct operation, the machine must be positioned on a hard bench, which does not amplify the effects of the internal movements occurring inside the machine. The machine consists of a vibrator which loads the contacts, of a tube which feeds the contacts and of a motorised wire stripping and contact crimping unit.

For each type and size of contact, the machine is provided with a factory stored preset program (see the machine user manual), which may be customised at any time.

The program allows the user to:

load, edit and save a program, as well as check/edit the stripping length and depth and the crimping depth.

**Warning:** when the machine is switched on, the working program is always the last program used.

The machine electronics adjustment is carried out by means of the keypad. Select one of the 12 programs (see table on page 728) according to the contact used\*.

Each program stores the stripping and crimping depth.

The stripping depth is the measurement in mm of how much the stripping blades must penetrate the insulator to strip it off, and depends on the type of cable used. The crimping depth is the measurement in mm of how much the four indenters must penetrate the contact at the end of the crimping operation.

This depth depends on the size and shape of the contact (crimp shaft thickness) and determines the quality of the crimping operation in terms of gas tightness and resistance to tensile stress.

\* **Note:** The machine also has a 12C program suitable for 10A, 2,5 mm<sup>2</sup> crimp contacts with 6 mm stripping length. This program is therefore unsuitable for ILME CD series contacts (stripping length 8 mm).

## Operational setups

The tool carrier carriage may be accessed by opening the front door, by anticlockwise rotation of the knob, which releases the pressure from all the valves. For tool selection, see table on page 728.

- For CD series male and female crimp contacts (10A max), the feeding cup A must be fitted onto the machine, whilst for CC series crimp contacts (16A max) feeding cup B (M) for male contacts and B (F) for female contacts must be used.
- The feeding tubes to be fitted are A for CD series contacts and B for CC series contacts respectively.
- The wire holders which support the wire during the stripping stage feature three different sizes for CD contacts and two sizes for CC contacts.
- The contact holders are two (A (M) for male contacts and A (F) for female contacts) for CD series contacts, according to the different rear diameter between male and female contacts in this series, whilst there is only one holder (B) for CC series contacts.
- The contact holder is A for CD series contacts and B for CC series contacts.

## Feeding the wire

The wire must be cut straight and the single braids must not be bent or pulled apart; in particular, the first 4cm must be perfectly straight.

## Checking the stripping depth:

The machine can be operated simply as a stripping machine by disabling the crimping operation.

Please refer to the machine user manual.

## Maintenance and repairs

Stripping residues collection tray: empty the tray approximately every 2000 cycles (the frequency depends on the sizes of the stripped wire and on the stripping length).

Pneumatically controlled maintenance unit: regularly drain any water that may have collected.

The trap may be cleaned with water.

To remove the trap, simply disconnect the air supply.

The filter unit may be unscrewed for cleaning purposes, then immersed in a cleaning agent (such as petrol or oil), thoroughly washed and dried.

## Checking the calibration values

The correct calibration of the machine must be periodically checked by using the "GO / NO GO" caliper supplied as standard with the machine, by following the procedure described in the machine user and maintenance manual.

# Tools and accessories for crimp contacts

for contacts series:

page:

CX PLF/PLM  
CX MLF/MLM

269  
269

manual crimping tool

Front view



polishing disc - polish paper -  
removal tool  
jacket stripper and fibre stripper  
cable cutter

CLES



description	part No.	part No.
crimping tool for POF <b>CX PL</b> and MOST <b>CX ML</b> contacts RENNSTEIG model *	<b>CLPZ R</b>	
polishing disc (RATIOPLAST 910 PS 0SC 00 001) for POF ** and MOST *** contacts		<b>CLDL</b>
polish paper: grain size 1000 (RATIOPLAST 910 PB 001 00 001) grain size 4000 (RATIOPLAST 910 PB 001 40 250)		<b>CLC1</b> <b>CLC4</b>
removal tool for the extraction of contacts from the CX L inserts		<b>CLES</b>
jacket stripper (RATIOPLAST 910 AZ 001 00 PA1) for POF ** and MOST *** fibre optic with PA jacket		<b>CLSG</b>
fibre stripper (RATIOPLAST 910 AB 001 00 001) for POF ** fibre optic		<b>CLSP</b>
cable cutter (RATIOPLAST 910 SW 001 00 001) for Ø 2,3 mm max, for POF ** and MOST *** fibre optic		<b>CLTE</b>

\* on request tool **CLPZ** RATIOPLAST 910 CZ 001 00 008 for contacts POF \*\*/MOST \*\*\* crimping on the back  
\*\* **POF = POLYMER OPTICAL FIBRE**  
\*\*\* **MOST = MEDIA ORIENTED SYSTEM TRANSPORT**

**Note:**  
as alternative to crimping please use glue UHU PLUS ENDFEST 300 (BICOMPONENT), part No. "CL GL" (provide a strain relief by cable glands)  
1) mix the two components on a sheet (just a drop/each)  
2) the stripped ca. 5 mm POF \*\* (that means the inner fibre) has to be dipped in the glue (just 5 mm)  
3) the POF \*\* has to be pushed now in the contact/ferrule  
4) min. one night to hard/dry the glue  
5) finally the POF \*\* has to be polished (polishing disc)

CLPZ R (Rear view)



CLDL



CLC1 / CLC4

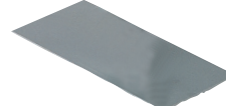

CLSG



CLSP



CLTE



# Use and maintenance instructions

## General specifications

Strip the fibre about 12 mm for male contact and about 15 mm for female contact (see Figures 1 and 2).

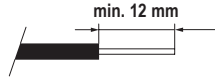

Fig. 1 - Example of cable stripping for male crimp contact

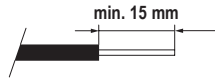

Fig. 2 - Example of cable stripping for female crimp contact

## Crimping instructions

- The data sheet for crimping tool **CLPZ R** explains how the crimping tool works and how to adjust the crimping depth and locator for the contacts to be crimped. Position the turret on 3, push and turn of 90° the knob of turret. Adjust the crimping depth on 2 (unscrew the allen screw, after adjusting refix the screw). For the female contact: unscrew the back of the contact, pull out the internal central part; on Figure 3 is indicated the crimping area (front part of contact). For male contact: crimp the front part of contact.
- Push the stripped fiber as far as possible into the contact sleeve so that it protrudes approx. 1 mm from the tip of the contact.

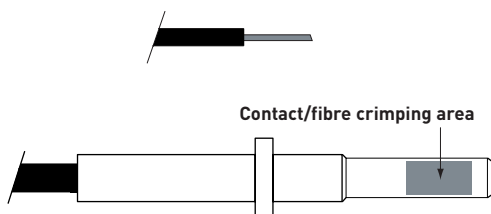
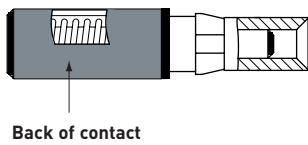

Fig. 3 - Female contact/fibre crimping area

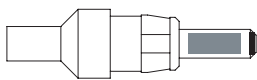

Fig. 4 - Male contact/fibre crimping area

- Insert the contact together with the fibre optic cable as far as possible into the crimping opening of the crimping tool (**CLPZ R**, see Figure 5) while applying gentle pressure to the fibre optic cable and connector, close the tool until you hear it disengages.

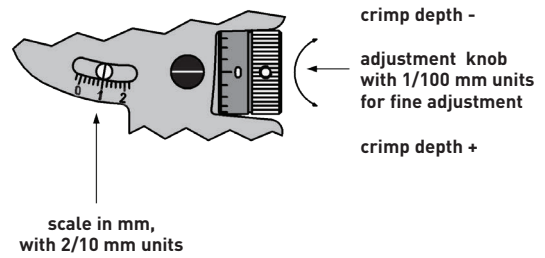
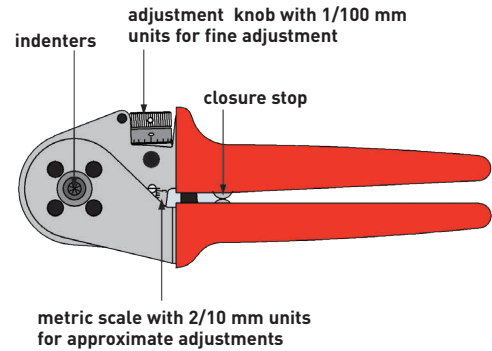

Fig. 5 - Manual crimping tool

## Finishing the front surface

- Insert the contact into the polishing disc (**CLDL**) as shown in Figure 6. Work on a smooth surface (such as a sheet of glass), use grade 1000 polishing paper to grind off the protruding fibre and polish it with grade 4000 polishing paper.
- Wipe away any residue remaining after grinding. The best optical attenuation values are achieved when a wet grinding method is used.

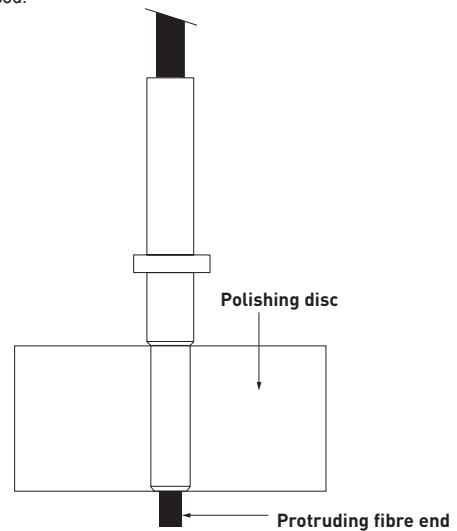

Fig. 6 - Polishing Disc with Guide for Connector Sleeve

## Final mounting instructions

Screw the back female part contact. Put inside the CX 04 LF/ CX 04 LM insert.

Tools and accessories for crimp contacts

for contacts series:

page:

manual crimping tool

polishing disc - polish paper -  
removal tool  
jacket stripper and fibre stripper  
cable cutter

CLF DD/CLM DD

677

Front view



CCES



description

part No.

part No.

RENNSTEIG model crimping tool  
for POF \* CLF DD / CLM DD contacts

CLPZ R

polishing disc (RATIOPLAST 910 PS 001 00 001)  
for POF \* contacts

CLDL DD

polish paper:  
grain size 1000 (RATIOPLAST 910 PB 001 00 001)  
grain size 4000 (RATIOPLAST 910 PB 001 40 250)

CLC1  
CLC4

removal tool, for the extraction of contacts from the  
CD, CDD, CX inserts

CCES

jacket stripper (RATIOPLAST 910 AZ 001 00 PA1)  
for POF \* fibre optic with PA jacket  
fibre stripper (RATIOPLAST 910 AB 001 00 001)  
for POF \* fibre optic

CLSG

CLSP

cable cutter (RATIOPLAST 910 SW 001 00 001)  
for Ø 2,3 mm max, for POF \* fibre optic

CLTE

\* POF = POLYMER OPTICAL FIBRE

CLPZ R (Rear view)



CLDL DD



CLC1 / CLC4

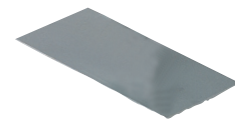

CLSG



CLSP



CLTE



CRIMPING TOOLS

# Use and maintenance instructions

### Finishing the front surface of the fibre optic

- Before crimping, insert POF fibre optic into the polishing disc (CLDL DD) as shown in Fig. 1.
- Work on a smooth surface (such as a sheet of glass), use grade 1000 polishing paper to grind off the protruding fibre and polish it with grade 4000 polishing paper.
- Polish making 8-shape circles.
- Wipe away any residue remaining after grinding.

The best optical attenuation values are achieved when a wet grinding method is used.

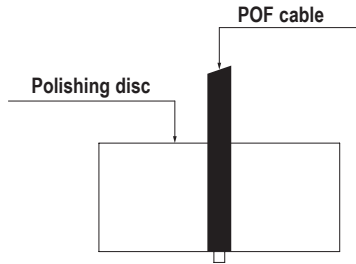

Fig. 1 - Polishing Disc with Guide for POF fibre

### General specifications

Strip the fibre 19 mm for male contact and 14 mm for female contact (refer to Figures 2 and 3).

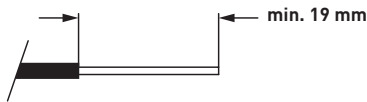

Fig. 2 - Example of cable stripping for male crimp contact

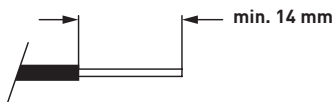

Fig. 3 - Example of cable stripping for female crimp contact

### Crimping instructions

- The CLPZ R crimping tool data sheet explains how the crimping tool works and how to adjust the crimping depth and locator to crimp the contacts as shown in Fig. 4.
- Select position no. 1 on the turret (for male contact) and no. 2 (for female contact), push and turn of 90° the knob of the turret.
- Adjust the crimping depth on 1,45 (unscrew the allen screw, after adjusting reflex the screw).
- Insert the contact together with the fibre optic cable as far as possible into the crimping opening of the crimping tool (CLPZ R, refer to Fig. 5) while applying gentle pressure to the fibre optic connector, close the tool until you hear it disengages.

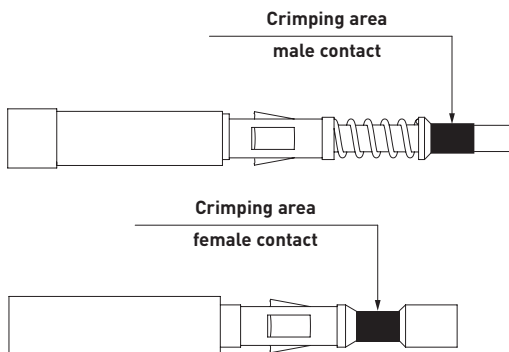

Fig. 4 - Crimping area

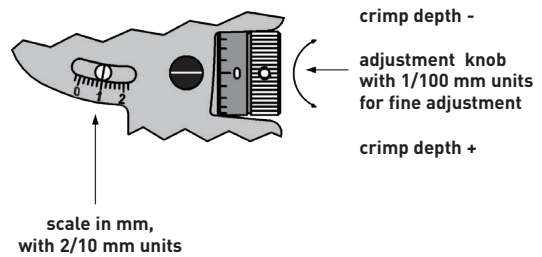
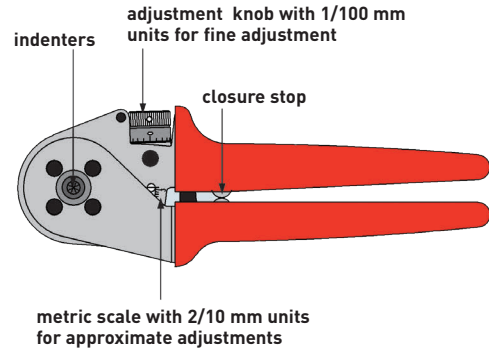

Fig. 5 - Manual crimping tool

### Final mounting instructions

Screw the back female part contact. Put inside the CD/CDD/CX insert.



Watch our online tutorial

## Tools and accessories for crimp contacts

for contacts series:

CX 50 RF/M  
CX 75 RF/M

page:

270  
270

manual crimping tool



removal tool  
coaxial cable stripper



description

part No.

part No.

crimping tool  
for CX 50 RF/M and CX 75 RF/M coaxial contacts

COPZ

removal tool  
for the extraction of contacts from the CX R inserts

CLES

coaxial cable stripper  
for the preparation of the cable according to the drawing

COST



Watch  
our  
online  
tutorial

conductor stripping

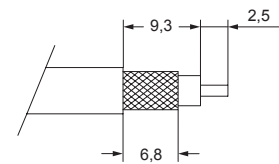

coaxial contacts	for cables	ø external	part No.
50Ω	RG 316/U	2,49 ±0,1	CX 50 RF
	RG 174/U	2,79 ±0,127	CX 50 RM
	RG 188 A/U	2,79 max	
75Ω	RG 179 B/U	2,54 ±0,127	CX 75 RF
	RG 187 A/U	2,79 max	CX 75 RM
	TZC 75 101	2,79 max	

### Crimping instructions

- 1) Strip the cable as per drawing using the tool COST.
- 2) Crimp the central contact of coaxial connector in the correct crimping area with the position 0,72 of crimping tool COPZ.
- 3) Insert the brass back end on the cable.
- 4) Insert the central contact in the coaxial connector, put the braid shield around the back cylinder of contact.
- 5) Insert the brass back end on the braid shield.
- 6) Crimp the ferrule with position 3,25 of crimping tool COPZ.

We recommend the use of code pins CRF CX / CRM CX.  
fit the brass tube on the cable  
As alternative to crimping, it is possible to solder the central contact.

### CX 50 RF/M and CX 75 RF/M coaxial contacts

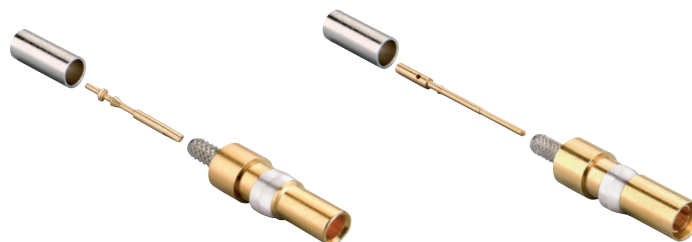



# Tools and accessories for crimp contacts

for insert series:

CJ (RJ45)  
MIXO (RJ45)

page:

305  
274 - 277

manual crimp pliers



shielded cable stripper



description	part No.	part No.
RJ45 CJ series plug insert crimp pliers basic tool YAMAICHI Y-ContTool-11 mod. with plug insert inserter	<b>CJPZ Y</b>	
Y-ContTool-20 cable stripper cuts the cable sheath and releases the wires in a single operation		<b>CJST</b>



Watch  
our CX 8 JM  
online  
tutorial

## How to use the RJ45 plug insert crimp pliers

CRIMPING TOOLS



# Tools and accessories for crimp contacts

inserts:

MIXO (RJ45) CX 8 J6M

page:

272

manual crimp pliers



shielded cable stripper



description

part No.

part No.

RJ45 CJ series plug insert crimp pliers

CJPZ T

cable stripper  
cuts the cable sheath and  
releases the wires in a single operation

CJST

## How to use the RJ45 plug insert crimp pliers

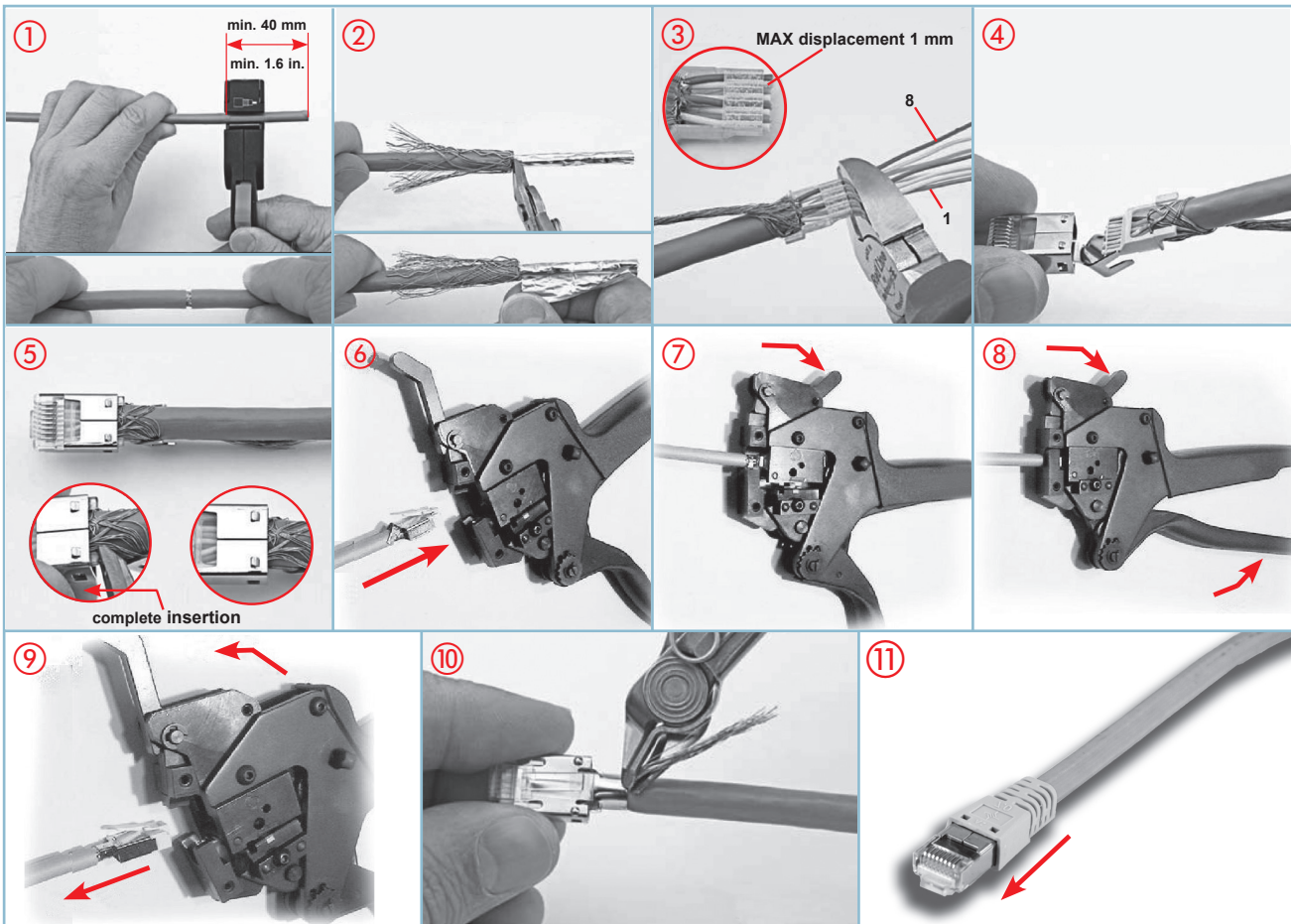

CRIMPING TOOLS



Watch our online tutorial

# Tools and accessories for crimp contacts

inserts:  
MIXO (RJ45) CX 8 J6IM

page:  
272

manual IDC pliers



description	part No.
wrenches pliers for CX 8 J6IM	CJPW K

RJ45 PIN No.	Connection		Application					
	Colour Code T568		DIN 47100	Industrial PROFINET	10BT/100BT	1 Gigabit 10 Gigabit Ethernet	Token Ring ISDN/So	Upo/TEL
	A	B						
1	WH-GN	WH-OG	WH	YE	•	•		
2	GN	OG	BN	OG	•	•		
3	WH-OG	WH-GN	GN	WH	•	•	•	
4	BU	BU	YE	-		•	•	•
5	WH-BU	WH-BU	GY	-		•	•	•
6	OG	GN	PK	BU	•	•	•	
7	WH-BN	WH-BN	BU	-		•		
8	BN	BN	RD	-		•		

**Legend**

- BN = brown
- BU = blue
- GN = green
- GY = grey
- OG = orange
- PK = pink
- RD = red
- WH = white
- YE = yellow



Watch our online tutorial

# for SQUICH® terminal

for insert series:

- CDSH
- CSAH
- CSH
- CMSH

page:

- 86 - 91
- 99 - 103
- 110 - 115
- 136 - 144

reopening tool



description

part No.

opening tool  
for SQUICH® actuator button

CSHES

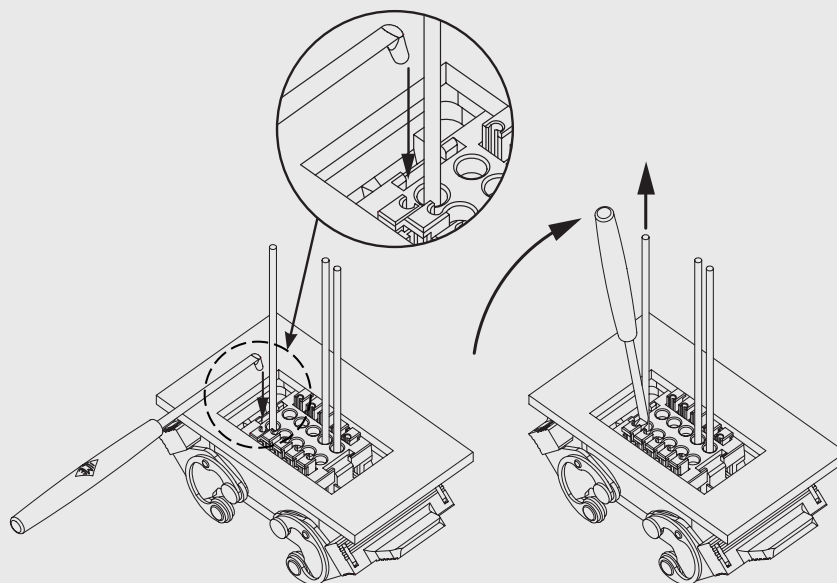
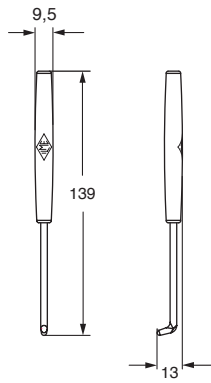

hydraulic panel punching tool



punching die

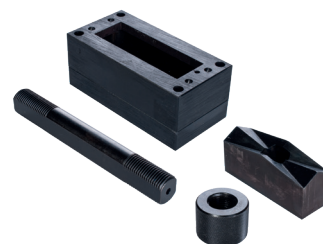

description	part No.	part No.
hydraulic punching tool (excluding punching die)	<b>CCW CT</b>	
punching unit for M25 hole		<b>CCW M25 2)</b>
punching units for panel cut out of bulkhead mounting housings		
for size 21.21 CK/CKA		<b>CCW PD 03</b>
for size 21.21 CKG IP68		<b>CCW PD 03G</b>
for size 49.16		<b>CCW PD 15</b>
for size 66.16		<b>CCW PD 25</b>
for size 44.27		<b>CCW PD 06</b>
for size 57.27		<b>CCW PD 10</b>
for size 77.27		<b>CCW PD 16</b>
for size 104.27		<b>CCW PD 24</b>

Rectangular punch mm	ILME Product Number	Draw stud 3)	Suggested pilot hole	Sheet thickness	Manual screw-wrench use	Hydraulic use
22,2 x 22,2	<b>CCW PD 03</b>	13,0/11,0 mm	14,5 mm	St./Fe. 2 mm	x	x (*)
21,3 x 21,3	<b>CCW PD 03 G</b>	13,0/11,0 mm	14,5 mm	St./Fe. 2 mm	x	x (*)
24,0 x 57,0	<b>CCW PD 15</b>	19,0/14,0 mm	20,4 mm M20	St./Fe. 3 mm		x
24,0 x 73,0	<b>CCW PD 25</b>	19,0/14,0 mm	20,4 mm M20	St./Fe. 3 mm		x
36,0 x 52,0	<b>CCW PD 06</b>	25,0/21,0 mm	25,4 mm M25 2)	St./Fe. 3 mm		x
36,0 x 65,0	<b>CCW PD 10</b>	25,0/21,0 mm	25,4 mm M25 2)	St./Fe. 3 mm		x
36,0 x 86,0	<b>CCW PD 16</b>	25,0/21,0 mm	25,4 mm M25 2)	St./Fe. 3 mm		x
36,0 x 112,0	<b>CCW PD 24</b>	25,0/21,0 mm	25,4 mm M25 2)	St./Fe. 3 mm		x

Accessory	ILME Product Number	Draw stud 3)	Suggested pilot hole	Sheet thickness	Manual screw-wrench use	Hydraulic use
punch and die 25,4 M25	<b>CCW M25 (***)</b>	3/8"	10 mm	St./Fe. 2 mm		x (**)
Hydraulic hand pump	<b>CCW CT</b>					

(\*) Adaptor (delivered with **CCW PD 03/03G**) and spacer (delivered with **CCW CT**) needed.

(\*\*) Adaptor M25 and spacer (delivered with **CCW CT**) needed.

(\*\*\*) **CCW M25** can be used to drill M25 hole

③, ⑥ and ⑦ delivered with **CCW CT**



**LEGEND:**

- ② Punch
- ③ Draw stud 3/8"
- ④ Die
- ⑥ Spacer
- ⑦ Adaptor 3/8" - 3/4" UNF

**Hydraulic operating instructions (CCW PD ..)**

1. Screw the short thread of the 13,0/11,0 mm draw stud (3) into the 3/4" UNF adaptor (7) (CCW PD 03/03 G only).
2. Screw the 13,0/11,0 mm draw stud (3) complete with the 3/4" UNF adaptor (7) onto the hydraulic cylinder or screw the short thread of any of the larger draw studs (3) (without the adaptor) directly onto the hydraulic cylinder (CCW PD 03/03 G only).
3. Put the die (4) onto the draw stud (3) and move it towards the hydraulic cylinder. If necessary, place the spacer (6) between the hydraulic cylinder and die (4).
4. Insert draw stud (3) with pre-mounted die through the pilot hole in the sheet until the die abuts the sheet.
5. Place the punch (2) onto the draw stud and move it towards the sheet until it abuts the sheet.
6. Screw the counter nut (1) onto the thread of the draw stud (3).
7. Adjust punch rectangularly (4 marks on die) and tighten counter nut manually.

**Punching**

8. Operate hydraulic punch CCW CT driver until punch is drawn through sheet.
9. Depressurise hydraulic punch driver after punching.
10. Remove the counter nut (1) and punch (2) from the draw stud (3).
11. Remove the die (4) from the draw stud (3) and remove slugs from the die (4).

**Drilling mounting holes**

When punching, the position of mounting holes are marked. Use suitable spiral drill to drill mounting holes.

**Manual operating instructions (CCW PD 03 / 03G only)**

**Knockout punch mounting**

1. Screw the ball-bearing nut (5) onto the long thread of the draw stud 13,0/11,0 mm (3). Put the die (4) onto the draw stud (3) and move it towards the ball bearing nut (5).
2. For further steps refer to hydraulic operating instructions steps 4 to 7.

**Punching**

3. Use screw wrench SW 24 to rotate ball-bearing nut (5) until punch is drawn through sheet.
4. For further steps refer to hydraulic operating instructions steps 10 to 11.

Prior to commissioning please read operating instructions  
 Components under voltage must not be machined.  
 Prior to operating ensure tensionless state of the work environment  
 (e.g. switch cabinet) or the material to be machined.

**Punching tool components**

**CCW CT**



**Hydraulic operating CCW PD ..  
 (except CCW PD 03/03G)**

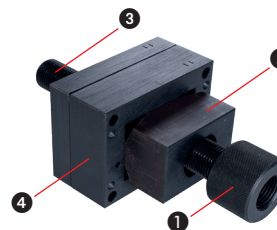

**Manual operating  
 (CCW PD 03/03G only)**

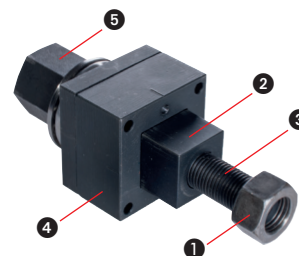

**Hydraulic operating  
 (CCW PD 03/03G only)**

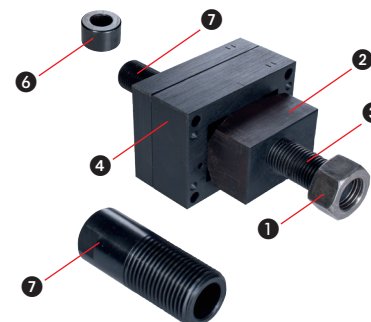

**LEGEND:**

- ① Counter nut
- ② Punch
- ③ Draw stud
- ④ Die
- ⑤ Ball-bearing nut
- ⑥ Spacer
- ⑦ Adaptor

## Use and maintenance instructions

				Draw stud	Adaptor	Spacer
Bulkhead housings Size	Punching die	Pilot hole	Mounting configuration	Delivered with	Delivered with	Delivered with
21.21	CCW PD 03	Ø 14,5 mm	<i>Hydraulic tool operation CCW CT</i> with adaptor and with spacer	CCW PD 03	CCW PD 03	CCW CT
21.21 (IP68)	CCW PD 03 G		<i>Manual operation</i> with screw ballbearing nut (no adaptor and spacer)	CCW PD 03 G	CCW PD 03 G	CCW CT
49.16	CCW PD 15	Ø 20,4 mm	<i>Hydraulic tool operation CCW CT</i> without adaptor and without spacer	CCW PD 15	ND	ND
66.16	CCW PD 25			CCW PD 25	ND	ND
44.27	CCW PD 06	Ø 25,4 mm	<i>Hydraulic tool operation CCW CT</i> without adaptor and without spacer	CCW PD 06	ND	ND
57.27	CCW PD 10			CCW PD 10	ND	ND
77.27	CCW PD 16			CCW PD 16	ND	ND
104.27	CCW PD 24			CCW PD 24	ND	ND
M25 hole or MKA IAF25 housings	CCW M25 dimensions Ø 25 mm	Ø 10 mm	<i>Hydraulic tool operation CCW CT</i> with adaptor and with spacer	CCW CT	CCW CT	CCW CT

ND = Not Needed





# APPENDIX

<b>INDEX PART NUMBERS</b> .....	744
<b>DIMENSIONING OF CLEARANCES AND CREEPAGE DISTANCES</b> .....	756
<b>EU ENVIRONMENTAL LEGISLATION</b> .....	762
<b>FIRE PROTECTION STANDARDS FOR RAILWAY APPLICATIONS</b> .....	763
<b>STANDARDS AND CERTIFICATIONS</b> .....	765
<b>SPECIFICATIONS</b> .....	765

**A**

AH M25IF ..... 505  
 AH M25IFL ..... 505  
 AH M32IF ..... 505  
 AH M32IFL ..... 505  
 AT 8FT ..... 319  
 AT 8IFT ..... 319  
 AT LCMM ..... 319  
 AT LCSM ..... 319  
 ATR C22 ..... 319  
 AT U2F ..... 319  
 AT U3F ..... 319  
 AW M25IJ ..... 315  
 AW M25INJ ..... 315  
 AW M25PJ ..... 315

**C**

C7 06 FL ..... 443  
 C7 10 FL ..... 443  
 C7 16 FL ..... 443  
 C7 24 FL ..... 443  
 C7AP 06 L ..... 436  
 C7AP 06 L2 ..... 436  
 C7AP 06 L29 ..... 436  
 C7AP 06 L229 ..... 436  
 C7AP 10.21 ..... 438  
 C7AP 10.22 ..... 438  
 C7AP 10.29 ..... 438  
 C7AP 10.221 ..... 438  
 C7AP 16.21 ..... 439  
 C7AP 16.29 ..... 439  
 C7AP 16.221 ..... 439  
 C7AP 16.229 ..... 439  
 C7AP 24.21 ..... 441  
 C7AP 24.29 ..... 441  
 C7AP 24.221 ..... 441  
 C7AP 24.229 ..... 441  
 C7ES ..... 720  
 C7I 06 L ..... 436, 656  
 C7I 06 LS ..... 437  
 C7I 10 ..... 438, 656  
 C7I 16 ..... 439, 656  
 C7I 16 S ..... 440  
 C7I 24 ..... 441, 656  
 C7I 24 S ..... 442  
 C7IE 06 L ..... 530  
 C7IE 10 ..... 532  
 C7IE 16 ..... 534  
 C7IE 24 ..... 536  
 C7P 06 L ..... 436  
 C7P 06 L2 ..... 436  
 C7P 10 ..... 438  
 C7P 10.2 ..... 438  
 C7P 16 ..... 439  
 C7P 16.2 ..... 439  
 C7P 24 ..... 441  
 C7P 24.2 ..... 441  
 CAC 06 L ..... 392  
 CAC 10 ..... 401  
 CAC 10 L ..... 401  
 CAC 16 ..... 411  
 CAC 16 L ..... 411  
 CAC 24 ..... 423  
 CAC 24 L ..... 423  
 CAF 10 ..... 395  
 CAF 16 ..... 404  
 CAF 16.221 ..... 406  
 CAF 24.21 ..... 414  
 CAF 24.29 ..... 414  
 CAF 24.221 ..... 416  
 CAN 24 ..... 421

CAO 06 L21 ..... 389  
 CAO 06 L29 ..... 389  
 CAO 06 YX21 ..... 604  
 CAO 06 YX29 ..... 604  
 CAO 10.21 ..... 395  
 CAO 10.29 ..... 395  
 CAO 10 L21 ..... 396  
 CAO 10 L29 ..... 396  
 CAO 10 X ..... 400  
 CAO 10 X29 ..... 400  
 CAO 10 YX21 ..... 607  
 CAO 10 YX29 ..... 607  
 CAO 16.21 ..... 404  
 CAO 16.29 ..... 404  
 CAO 16 L21 ..... 405  
 CAO 16 L29 ..... 405  
 CAO 16 X ..... 410  
 CAO 16 X29 ..... 410  
 CAO 16 YX21 ..... 610  
 CAO 16 YX29 ..... 610  
 CAO 24.21 ..... 414  
 CAO 24.29 ..... 414  
 CAO 24 L21 ..... 415  
 CAO 24 L29 ..... 415  
 CAO 24 X ..... 422  
 CAO 24 X29 ..... 422  
 CAO 24 YX21 ..... 613  
 CAO 24 YX29 ..... 613  
 CAO 50.21 ..... 432  
 CAO 50.29 ..... 432  
 CAO 50 X ..... 433  
 CAO 50 X29 ..... 433  
 CAOR 06 L21 ..... 586  
 CAOR 10.21 ..... 587  
 CAOR 16.21 ..... 588  
 CAOR 24.29 ..... 589  
 CAOS 10.21 ..... 579  
 CAOS 16.29 ..... 580  
 CAOS 24.29 ..... 581  
 CAOW 06 L21 ..... 521  
 CAOW 10.21 ..... 522  
 CAOW 16.29 ..... 523  
 CAOW 24.29 ..... 524  
 CAOW 50.29 ..... 527  
 CAP 06 L ..... 388  
 CAP 06 L2 ..... 388  
 CAP 06 L29 ..... 388  
 CAP 06 L229 ..... 388  
 CAP 06 LS ..... 388  
 CAP 06 LS2 ..... 388  
 CAP 06 LS29 ..... 388  
 CAP 06 LS229 ..... 388  
 CAP 06 YC229 ..... 603  
 CAP 10.21 ..... 394  
 CAP 10.29 ..... 394  
 CAP 10.221 ..... 394  
 CAP 10.229 ..... 394  
 CAP 10 CP ..... 394  
 CAP 10 CP2 ..... 394  
 CAP 10 CP29 ..... 394  
 CAP 10 CP229 ..... 394  
 CAP 10 CS ..... 394  
 CAP 10 CS2 ..... 394  
 CAP 10 CS29 ..... 394  
 CAP 10 CS229 ..... 394  
 CAP 10 L ..... 394  
 CAP 10 L2 ..... 394  
 CAP 10 L29 ..... 394  
 CAP 10 L229 ..... 394  
 CAP 10 LS ..... 394  
 CAP 10 LS2 ..... 394  
 CAP 10 LS29 ..... 394  
 CAP 10 LS229 ..... 394

CAP 10 YC229 ..... 606  
 CAP 16.21 ..... 403  
 CAP 16.29 ..... 403  
 CAP 16.221 ..... 403  
 CAP 16.229 ..... 403  
 CAP 16 CP ..... 403  
 CAP 16 CP2 ..... 403  
 CAP 16 CP29 ..... 403  
 CAP 16 CP229 ..... 403  
 CAP 16 CS ..... 403  
 CAP 16 CS2 ..... 403  
 CAP 16 CS29 ..... 403  
 CAP 16 CS229 ..... 403  
 CAP 16 L ..... 403  
 CAP 16 L2 ..... 403  
 CAP 16 L29 ..... 403  
 CAP 16 L229 ..... 403  
 CAP 16 LS ..... 403  
 CAP 16 LS2 ..... 403  
 CAP 16 LS29 ..... 403  
 CAP 16 LS229 ..... 403  
 CAP 16 YC229 ..... 609  
 CAP 24.21 ..... 413  
 CAP 24.29 ..... 413  
 CAP 24.221 ..... 413  
 CAP 24.229 ..... 413  
 CAP 24 CP ..... 413  
 CAP 24 CP2 ..... 413  
 CAP 24 CP29 ..... 413  
 CAP 24 CP229 ..... 413  
 CAP 24 CS ..... 413  
 CAP 24 CS29 ..... 413  
 CAP 24 CS229 ..... 413  
 CAP 24 G36 ..... 657  
 CAP 24 L ..... 413  
 CAP 24 L2 ..... 413  
 CAP 24 L29 ..... 413  
 CAP 24 L229 ..... 413  
 CAP 24 LS ..... 413  
 CAP 24 LS2 ..... 413  
 CAP 24 LS29 ..... 413  
 CAP 24 LS229 ..... 413  
 CAP 24 YC229 ..... 612  
 CAPR 10.21 ..... 587  
 CAPR 16.21 ..... 588  
 CAPR 24.21 ..... 589  
 CAPS 06 L ..... 578  
 CAPS 10.21 ..... 579  
 CAPS 16.21 ..... 580  
 CAPS 24.21 ..... 581  
 CAPW 06 L ..... 521  
 CAPW 10.21 ..... 522  
 CAPW 16.21 ..... 523  
 CAPW 24.21 ..... 524  
 CAV 06 GYC21 ..... 605  
 CAV 06 GYC29 ..... 605  
 CAV 06 L21 ..... 389  
 CAV 06 L29 ..... 389  
 CAV 06 LG21 ..... 390  
 CAV 06 LG29 ..... 390  
 CAV 06 YX21 ..... 604  
 CAV 06 YX29 ..... 604  
 CAV 10.21 ..... 395  
 CAV 10.29 ..... 395  
 CAV 10.213 ..... 397  
 CAV 10 G ..... 398  
 CAV 10 G29 ..... 398  
 CAV 10 GYC21 ..... 608  
 CAV 10 GYC29 ..... 608  
 CAV 10 L21 ..... 396  
 CAV 10 L29 ..... 396  
 CAV 10 LG21 ..... 399  
 CAV 10 LG29 ..... 399

CAV 10 X ..... 400  
 CAV 10 X29 ..... 400  
 CAV 10 YX21 ..... 607  
 CAV 10 YX29 ..... 607  
 CAV 16.21 ..... 404  
 CAV 16.29 ..... 404  
 CAV 16.216 ..... 406  
 CAV 16.221 ..... 406  
 CAV 16 G ..... 408  
 CAV 16 G29 ..... 408  
 CAV 16 GYC21 ..... 611  
 CAV 16 GYC29 ..... 611  
 CAV 16 L21 ..... 405  
 CAV 16 L29 ..... 405  
 CAV 16 LG21 ..... 409  
 CAV 16 LG29 ..... 409  
 CAV 16 X ..... 410  
 CAV 16 X29 ..... 410  
 CAV 16 YX21 ..... 610  
 CAV 16 YX29 ..... 610  
 CAV 24.21 ..... 414  
 CAV 24.29 ..... 414  
 CAV 24.221 ..... 416  
 CAV 24.229 ..... 416  
 CAV 24 G ..... 419  
 CAV 24 G29 ..... 419  
 CAV 24 GYC21 ..... 614  
 CAV 24 GYC29 ..... 614  
 CAV 24 L21 ..... 415  
 CAV 24 L29 ..... 415  
 CAV 24 LG21 ..... 420  
 CAV 24 LG29 ..... 420  
 CAV 24 X ..... 422  
 CAV 24 X29 ..... 422  
 CAV 24 YX21 ..... 613  
 CAV 24 YX29 ..... 613  
 CAV 50.21 ..... 432  
 CAV 50.29 ..... 432  
 CAV 50 G29 ..... 432  
 CAV 50 X ..... 433  
 CAV 50 X29 ..... 433  
 CAVR 06 L21 ..... 586  
 CAVR 10.21 ..... 587  
 CAVR 16.21 ..... 588  
 CAVR 24.29 ..... 589  
 CAVS 10.21 ..... 579  
 CAVS 16.29 ..... 580  
 CAVS 24.29 ..... 581  
 CAVW 06 L21 ..... 521  
 CAVW 06 LG ..... 521  
 CAVW 10.21 ..... 522  
 CAVW 10 G ..... 522  
 CAVW 16.29 ..... 523  
 CAVW 16 G29 ..... 523  
 CAVW 24.29 ..... 524  
 CAVW 50.29 ..... 527  
 CBC 06 L ..... 467  
 CBC 10 ..... 469  
 CBC 16 ..... 471  
 CBC 24 ..... 473  
 CBGF ..... 698  
 CC 0.5 AN ..... 104\*  
 CC 0.7 AN ..... 104\*  
 CC 1.0 AN ..... 104\*  
 CC 1.5 AN ..... 104\*  
 CC 2.5 AN ..... 104\*  
 CCEF 06 ..... 130\*  
 CCEF 10 ..... 131\*  
 CCEF 16 ..... 132\*  
 CCEF 16 N ..... 134  
 CCEF 24 ..... 133\*  
 CCEF 24 N ..... 135  
 CCEM 06 ..... 130\*

\* These items are also shown in various sections throughout the catalogue

CCEM 10.....	131*	CCMJD 0.3.....	675	CDF 07 N.....	66	CDSHM 27 N.....	90, 91
CCEM 16.....	132*	CCMJD 0.5.....	675	CDF 08.....	67	CDSHM 42.....	89, 91
CCEM 16 N.....	134	CCMJD 0.7.....	675	CDF 15.....	68	CDSHM 42 N.....	91
CCEM 24.....	133*	CCMJD 1.0.....	675	CDF 25.....	69, 71	CFF 10.....	395
CCEM 24 N.....	135	CCMJD 1.5.....	675	CDF 25 Z.....	71	CFF 16.....	404
CCES.....	708*	CCMJD 2.5.....	675	CDF 40.....	70, 73	CFF 16.221.....	406
CCF2D 0.3.....	675	CCMJD 3.0.....	675	CDF 64.....	72, 74	CFF 24.21.....	414
CCF2D 0.5.....	675	CCMJD 4.0.....	675	CDFA 0.3.....	66*	CFF 24.29.....	414
CCF2D 0.7.....	675	CCPNP.....	708*	CDFA 0.5.....	66*	CFF 24.221.....	416
CCF2D 1.0.....	675	CCPNP RN.....	714	CDFA 0.7.....	66*	CFO 06 L21.....	389
CCF2D 1.5.....	675	CCPR RN.....	708*	CDFA 1.0.....	66*	CFO 06 L29.....	389
CCF2D 2.5.....	675	CCPZ MIL.....	708	CDFA 1.5.....	66*	CFO 10.21.....	395
CCF2D 3.0.....	675	CCPZP.....	722	CDFA 2.5.....	66*	CFO 10.29.....	395
CCF2D 4.0.....	675	CCPZPA.....	724	CDFA 6A.....	670	CFO 10 L21.....	396
CCFA 0.3.....	104*	CCPZ RN.....	714	CDFA 6A28.....	672	CFO 10 L29.....	396
CCFA 0.5.....	104*	CCPZ TP.....	710	CDFD 0.3.....	66*	CFO 16.21.....	404
CCFA 0.7.....	104*	CCSPZP.....	722, 726	CDFD 0.5.....	66*	CFO 16.29.....	404
CCFA 1.0.....	104*	CCTP 10.....	708, 722	CDFD 0.7.....	66*	CFO 16 L21.....	405
CCFA 1.5.....	104*	CCTP 16.....	708, 722	CDFD 1.0.....	66*	CFO 16 L29.....	405
CCFA 2.5.....	104*	CCTPACF.....	724	CDFD 1.5.....	66*	CFO 24.21.....	414
CCFA 3.0.....	104*	CCTPACM.....	724	CDFD 2.5.....	66*	CFO 24.29.....	414
CCFA 4.0.....	104*	CCTPADF.....	724	CDFD 6A.....	670	CFO 24 L21.....	415
CCFC 0.3.....	673	CCTPADM.....	724	CDFJD 0.3.....	674	CFO 24 L29.....	415
CCFC 0.5.....	673	CCVPP.....	722, 726	CDFJD 0.5.....	674	CFO 32.....	426
CCFD 0.3.....	104*	CCW CT.....	739	CDFJD 0.7.....	674	CFO 32.29.....	426
CCFD 0.5.....	104*	CCW M25.....	739	CDFJD 1.0.....	674	CFO 32.42.....	426
CCFD 0.7.....	104*	CCW PD 03.....	739	CDFJD 1.5.....	674	CFO 32 L.....	426
CCFD 1.0.....	104*	CCW PD 03G.....	739	CDFJD 2.5.....	674	CFO 32 X.....	427
CCFD 1.5.....	104*	CCW PD 06.....	739	CDM2D 0.3.....	674	CFO 48 L.....	430
CCFD 2.5.....	104*	CCW PD 10.....	739	CDM2D 0.5.....	674	CFO 48 L29.....	430
CCFD 3.0.....	104*	CCW PD 15.....	739	CDM2D 0.7.....	674	CFO 48 L42.....	430
CCFD 4.0.....	104*	CCW PD 16.....	739	CDM2D 1.0.....	674	CFO 50.21.....	432
CCFF 0.3.....	673	CCW PD 24.....	739	CDM2D 1.5.....	674	CFO 50.29.....	432
CCFF 0.5.....	673	CCW PD 25.....	739	CDM2D 2.5.....	674	CFO 50 X.....	433
CCFFA.....	671	CDAF 10.....	98, 100	CDM 07.....	66	CFO 50 X29.....	433
CCFJD 0.3.....	675	CDAF 10 X.....	100, 106	CDM 07 N.....	66	CFOS 06 L21.....	578
CCFJD 0.5.....	675	CDAF 16.....	100, 102	CDM 08.....	67	CFV 06 GYC21.....	605
CCFJD 0.7.....	675	CDAF 16 N.....	102	CDM 15.....	68	CFV 06 GYC29.....	605
CCFJD 1.0.....	675	CDAF 16 X.....	100, 102	CDM 25.....	69, 71	CFV 06 L21.....	389
CCFJD 1.5.....	675	CDAF 16 XN.....	102	CDM 25 Z.....	71	CFV 06 L29.....	389
CCFJD 2.5.....	675	CDAM 10.....	100, 106	CDM 40.....	70, 73	CFV 06 LG21.....	390
CCFJD 3.0.....	675	CDAM 10 X.....	98, 100	CDM 64.....	72, 74	CFV 06 LG29.....	390
CCFJD 4.0.....	675	CDAM 16.....	100, 102	CDMA 0.3.....	66*	CFV 10.21.....	395
CCINA.....	708*	CDAM 16 N.....	102	CDMA 0.5.....	66*	CFV 10.29.....	395
CCM2D 0.3.....	675	CDAM 16 X.....	100, 102	CDMA 0.7.....	66*	CFV 10.213.....	397
CCM2D 0.5.....	675	CDAM 16 XN.....	102	CDMA 1.0.....	66*	CFV 10 G.....	398
CCM2D 0.7.....	675	CDCF 10.....	104*	CDMA 1.5.....	66*	CFV 10 G29.....	398
CCM2D 1.0.....	675	CDCF 16.....	105, 106	CDMA 2.5.....	66*	CFV 10 GYC21.....	608
CCM2D 1.5.....	675	CDCF 16 N.....	106	CDMA 6A.....	670, 672	CFV 10 GYC29.....	608
CCM2D 2.5.....	675	CDCM 10.....	104*	CDMD 0.3.....	66*	CFV 10 L21.....	396
CCM2D 3.0.....	675	CDCM 16.....	105, 106	CDMD 0.5.....	66*	CFV 10 L29.....	396
CCM2D 4.0.....	675	CDCM 16 N.....	106	CDMD 0.7.....	66*	CFV 10 LG21.....	399
CCMA 0.3.....	104	CDDF 24.....	76	CDMD 1.0.....	66*	CFV 10 LG29.....	399
CCMA 0.5.....	104*	CDDF 38.....	77, 80	CDMD 1.5.....	66*	CFV 16.21.....	404
CCMA 0.7.....	104*	CDDF 42.....	78	CDMD 2.5.....	66*	CFV 16.29.....	404
CCMA 1.0.....	104*	CDDF 72.....	79, 82	CDMD 6A.....	670	CFV 16.216.....	406
CCMA 1.5.....	104*	CDDF 72 N.....	82	CDMJD 0.3.....	674	CFV 16.221.....	406
CCMA 2.5.....	104*	CDDF 108.....	81, 83	CDMJD 0.5.....	674	CFV 16 G.....	408
CCMA 3.0.....	104*	CDDF 108 N.....	83	CDMJD 0.7.....	674	CFV 16 G29.....	408
CCMA 4.0.....	104*	CDDM 24.....	76	CDMJD 1.0.....	674	CFV 16 GYC21.....	611
CCMC 0.3.....	673	CDDM 38.....	77, 80	CDMJD 1.5.....	674	CFV 16 GYC29.....	611
CCMC 0.5.....	673	CDDM 42.....	78	CDMJD 2.5.....	674	CFV 16 L21.....	405
CCMD 0.3.....	104*	CDDM 72.....	79, 82	CDSHF 06 NC.....	95	CFV 16 L29.....	405
CCMD 0.5.....	104*	CDDM 72 N.....	82	CDSHF 09.....	86, 88	CFV 16 LG21.....	409
CCMD 0.7.....	104*	CDDM 108.....	81, 83	CDSHF 18.....	87, 89	CFV 16 LG29.....	409
CCMD 1.0.....	104*	CDDM 108 N.....	83	CDSHF 27.....	88, 90, 91	CFV 24.21.....	414
CCMD 1.5.....	104*	CDF2D 0.3.....	674	CDSHF 27 N.....	90, 91	CFV 24.29.....	414
CCMD 2.5.....	104*	CDF2D 0.5.....	674	CDSHF 42.....	89, 91	CFV 24.221.....	416
CCMD 3.0.....	104*	CDF2D 0.7.....	674	CDSHF 42 N.....	91	CFV 24 G.....	419
CCMD 4.0.....	104*	CDF2D 1.0.....	674	CDSHM 06 NC.....	95	CFV 24 G29.....	419
CCMF 0.3.....	673	CDF2D 1.5.....	674	CDSHM 09.....	86, 88	CFV 24 GYC21.....	614
CCMF 0.5.....	673	CDF2D 2.5.....	674	CDSHM 18.....	87, 89	CFV 24 GYC29.....	614
CCMFA.....	671	CDF 07.....	66	CDSHM 27.....	88, 90, 91	CFV 24 L21.....	415

\* These items are also shown in various sections throughout the catalogue

CFV 24 L29.....	415	CGMA 10.....	206, 234, 235	CHC 10 S.....	400	CHCW 32 G.....	525
CFV 24 LG21.....	420	CGMA 16.....	206, 234, 235	CHC 10 SL.....	400	CHCW 50.....	527
CFV 24 LG29.....	420	CGMA 25.....	206, 234, 235	CHC 16.....	410	CHCW 50 G.....	527
CFV 32.....	426	CGMA 35.....	206, 234, 235	CHC 16 C.....	410	CHES.....	250
CFV 32.29.....	426	CGO 06.16.....	633	CHC 16 G.....	410	CHI 06 L.....	387, 656
CFV 32.42.....	426	CGO 06.16 B.....	635	CHC 16 L.....	410	CHI 06 LC.....	387
CFV 32 G.....	426	CGO 06.21.....	633	CHC 16 LG.....	410	CHI 06 LCH.....	656
CFV 32 G29.....	426	CGO 06.21 B.....	635	CHC 16 S.....	410	CHI 06 LCP.....	387
CFV 32 G42.....	426	CGO 06.29.....	633	CHC 16 SL.....	410	CHI 06 LCS.....	387
CFV 32 L.....	426	CGO 06.29 B.....	635	CHC 24.....	422	CHI 06 LS.....	387
CFV 32 LG.....	426	CGO 10.16.....	637	CHC 24 C.....	422	CHI 06 YC.....	603
CFV 32 X.....	427	CGO 10.16 B.....	639	CHC 24 G.....	422	CHI 10.....	393, 656
CFV 48 L.....	430	CGO 10.21.....	637	CHC 24 L.....	422	CHI 10 C.....	393
CFV 48 L29.....	430	CGO 10.21 B.....	639	CHC 24 LG.....	422	CHI 10 CH.....	656
CFV 48 L42.....	430	CGO 10.29.....	637	CHC 24 S.....	422	CHI 10 CP.....	393
CFV 50.21.....	432	CGO 10.29 B.....	639	CHC 24 SL.....	422	CHI 10 CS.....	393
CFV 50.29.....	432	CGO 16.21.....	641	CHC 32.....	427	CHI 10 L.....	393
CFV 50 G29.....	432	CGO 16.21 B.....	643	CHC 32 C.....	427	CHI 10 LS.....	393
CFV 50 X.....	433	CGO 16.29.....	641	CHC 32 G.....	427	CHI 10 YC.....	606
CFV 50 X29.....	433	CGO 16.29 B.....	643	CHC 32 L.....	427	CHI 16.....	402, 656
CFVS 06 L21.....	578	CGO 16.36.....	641	CHC 32 LG.....	427	CHI 16 C.....	402
CG 06 FL.....	648	CGO 16.36 B.....	643	CHC 32 S.....	427	CHI 16 CH.....	656
CG 10 FL.....	648	CGO 24.21.....	645	CHC 32 SL.....	427	CHI 16 CP.....	402
CG 16 FL.....	648	CGO 24.21 B.....	647	CHC 50.....	433	CHI 16 CS.....	402
CG 24 FL.....	648	CGO 24.29.....	645	CHC 50 G.....	433	CHI 16 L.....	402
CGC 06.....	633	CGO 24.29 B.....	647	CHC 50 S.....	433	CHI 16 LS.....	402
CGC 06 B.....	635	CGO 24.36.....	645	CHCE 06 L.....	542	CHI 16 YC.....	609
CGC 10.....	637	CGO 24.36 B.....	647	CHCE 06 LG.....	542	CHI 24.....	412, 656
CGC 10 B.....	639	CGP 06.29.....	632	CHCE 10.....	543	CHI 24 C.....	412
CGC 16.....	641	CGP 10.29.....	636	CHCE 10 G.....	543	CHI 24 CH.....	656
CGC 16 B.....	643	CGP 16.36.....	640	CHCE 16.....	544	CHI 24 CP.....	412
CGC 24.....	645	CGP 24.36.....	644	CHCE 16 G.....	544	CHI 24 CS.....	412
CGC 24 B.....	647	CGP 24.236.....	644	CHCE 32.....	546	CHI 24 L.....	412
CGCE 06.....	551	CGPZ LOC.....	720	CHCE 32 G.....	546	CHI 24 LS.....	412
CGCE 10.....	553	CGT 6.0.....	289	CHCE 50.....	548	CHI 24 YC.....	612
CGCE 16.....	555	CGT 10.....	289	CHCE 50 G.....	548	CHI 32.....	424
CGCE 24.....	557	CGT 16.....	234, 235, 289	CHCN 06 L.....	619	CHI 32 CS.....	424
CGCP 06 FX.....	697	CGT 25.....	289	CHCN 06 LG.....	619	CHI 32 L.....	424
CGCP 06 MB.....	697	CGV 06.16.....	633	CHCN 10.....	621	CHI 32 LS.....	424
CGCP 10 FX.....	697	CGV 06.16 B.....	635	CHCN 10 G.....	621	CHI 48 L.....	430
CGCP 10 MB.....	697	CGV 06.21.....	633	CHCN 16.....	623	CHI 48 LS.....	430
CGCP 16 FX.....	697	CGV 06.21 B.....	635	CHCN 16 G.....	623	CHI 50.....	431
CGCP 16 MB.....	697	CGV 06.29.....	633	CHCN 24.....	625	CHI 50 CS.....	431
CGCP 24 FX.....	697	CGV 06.29 B.....	635	CHCN 24 G.....	625	CHIE 06 L.....	542
CGCP 24 MB.....	697	CGV 10.16.....	637	CHCP 06.....	696	CHIE 10.....	543
CGD 10 C.....	720	CGV 10.21.....	637	CHCP 10.....	696	CHIE 16.....	544
CGD 16 C.....	720	CGV 16.21.....	641	CHCP 10 V.....	696	CHIE 24.....	545
CGD 25 C.....	720	CGV 16.21 B.....	643	CHCP 16.....	696	CHIE 32.....	546
CGD 35 C.....	720	CGV 16.29.....	641	CHCP 24.....	696	CHIE 48 LS.....	547
CGFA 10.....	206, 234, 235	CGV 16.29 B.....	643	CHCR 06 L.....	586	CHIE 50.....	548
CGFA 16.....	206, 234, 235	CGV 16.36.....	641	CHCR 10.....	587	CHIN 06 L.....	618
CGFA 25.....	206, 234, 235	CGV 16.36 B.....	643	CHCR 10 G.....	587	CHIN 06 LCH.....	618
CGFA 35.....	206, 234, 235	CGV 16.221.....	641	CHCR 16.....	588	CHIN 10.....	620
CGI 06.....	632	CGV 16.221 B.....	643	CHCR 16 G.....	588	CHIN 10 CH.....	620
CGI 06 B.....	634	CGV 24.21.....	645	CHCR 24.....	589	CHIN 16.....	622
CGI 10.....	636	CGV 24.21 B.....	647	CHCR 24 G.....	589	CHIN 16 CH.....	622
CGI 10 B.....	638	CGV 24.29.....	645	CHCS 06 L.....	578	CHIN 24.....	624
CGI 16.....	640	CGV 24.29 B.....	647	CHCS 06 LG.....	578	CHIN 24 CH.....	624
CGI 16 B.....	642	CGV 24.36.....	645	CHCS 10.....	579	CHIR 10.....	587
CGI 24.....	644	CGV 24.36 B.....	647	CHCS 10 G.....	579	CHIR 16.....	588
CGI 24 B.....	646	CGV 24.36 B.....	647	CHCS 16.....	580	CHIR 24.....	589
CGIE 06.....	550	CGV 24.229.....	645	CHCS 16 G.....	580	CHIR 48 LS.....	590
CGIE 10.....	552	CGV 24.229 B.....	647	CHCS 24.....	581	CHIS 06 L.....	578
CGIE 16.....	554	CH1ES.....	249	CHCS 24 G.....	581	CHIS 10.....	579
CGIE 24.....	556	CHC 06 L.....	391	CHCW 06 L.....	521	CHIS 16.....	580
CGKCP FX.....	697	CHC 06 LC.....	391	CHCW 06 LG.....	521	CHIS 24.....	581
CGKCP MB.....	697	CHC 06 LG.....	391	CHCW 10.....	522	CHIW 06 L.....	521
CGK I.....	628	CHC 06 SL.....	391	CHCW 10 G.....	522	CHIW 10.....	522
CGK IA.....	628	CHC 10.....	400	CHCW 16.....	523	CHIW 16.....	523
CGK IAP13.....	628	CHC 10 C.....	400	CHCW 16 G.....	523	CHIW 24.....	524
CGK I B.....	630	CHC 10 G.....	400	CHCW 24.....	524	CHIW 32.....	525
CGK V13.....	629	CHC 10 L.....	400	CHCW 24 G.....	524	CHIW 48 LS.....	526
CGK V13 B.....	631	CHC 10 LG.....	400	CHCW 32.....	525	CHIW 50.....	527

\* These items are also shown in various sections throughout the catalogue

CHIX 32 L.....	428	CHP 32.29.....	425	CHVR 10.....	587	CK 03 I.....	339
CHIX 32 LP.....	428	CHP 32.42.....	425	CHVR 16.....	588	CK 03 IA.....	339
CHIX 32 LS.....	428	CHP 32.229.....	425	CHVR 24.....	589	CK 03 IAN.....	339
CHO 06 L13.....	389	CHP 32.242.....	425	CHVR 48 L.....	590	CK 03 IAPNS.....	339
CHO 06 L16.....	389	CHP 32 L.....	425	CHVS 16.....	580	CK 03 IAPS.....	339
CHO 06 LX16.....	391	CHP 32 L2.....	425	CHVS 24.....	581	CK 03 IN.....	339, 346
CHO 10.....	395	CHP 32 L29.....	425	CHVV 16.....	523	CK 03 VANS.....	340
CHO 10 L.....	396	CHP 32 L42.....	425	CHVV 24.....	524	CK 03 VAS.....	340
CHO 10 X.....	400	CHP 32 L229.....	425	CHVV 24 G.....	524	CK 03 VGNS.....	340
CHO 16.....	404	CHP 32 L242.....	425	CHVV 32.....	525	CK 03 VGS.....	340
CHO 16 L.....	405	CHP 32 LS.....	425	CHVV 32 G.....	525	CK 03 VNS.....	340
CHO 16 X.....	410	CHP 32 LS2.....	425	CHVV 48 L.....	526	CK 03 VS.....	340
CHO 24.....	414	CHP 32 LS29.....	425	CIES.....	716	CKA 03 APS.....	349
CHO 24 L.....	415	CHP 32 LS42.....	425	CIES B.....	716	CKA 03 C.....	351
CHO 24 X.....	422	CHP 32 LS229.....	425	CIF 2.4.....	670	CKA 03 CA.....	351
CHO 32.....	426	CHP 32 LS242.....	425	CIF 2.4 A.....	670	CKA 03 CAS.....	351
CHO 32.29.....	426	CHP 48 LS.....	430	CIFA 0.2.....	190*	CKA 03 CS.....	351
CHO 32.42.....	426	CHP 48 LS29.....	430	CIFA 0.3.....	190*	CKA 03 I.....	349
CHO 32 L.....	426	CHP 50.21.....	431	CIFA 0.5.....	190*	CKA 03 IA.....	349
CHO 32 X.....	427	CHP 50.29.....	431	CIFA 0.7.....	254	CKA 03 IA4.....	357
CHO 48 L.....	430	CHP 50.221.....	431	CIFD 0.2.....	190*	CKA 03 IAPS.....	349
CHO 48 L29.....	430	CHP 50.229.....	431	CIFD 0.3.....	190*	CKA 03 ILS.....	350
CHO 48 L42.....	430	CHP 50 CS.....	431	CIFD 0.5.....	190*	CKA 03 ILSA.....	350
CHO 50.....	432	CHP 50 CS2.....	431	CIFD 0.7.....	254	CKA 03 VAS.....	351
CHO 50 X.....	433	CHP 50 CS29.....	431	CIF Q4/2 2.4.....	672	CKA 03 VGS.....	351
CHOR 06 L13.....	586	CHP 50 CS229.....	431	CIF Q08 1.6.....	671	CKA 03 VS.....	351
CHOR 10.....	587	CHPR 10.....	587	CIMA 0.2.....	190*	CKAG 03 C.....	354
CHOR 16.....	588	CHPR 48 LS.....	590	CIMA 0.3.....	190*	CKAG 03 V.....	355
CHOR 24.....	589	CHPW 32.....	525	CIMA 0.5.....	190*	CKAG 03 VA.....	355
CHOR 48 L.....	590	CHPW 48 LS.....	526	CIMA 0.7.....	254	CKAR 03 V.....	583
CHOS 16.....	580	CHPW 50.21.....	527	CIMD 0.2.....	190*	CKAR 03 VA.....	583
CHOS 24.....	581	CHPW 50.229.....	527	CIMD 0.3.....	190*	CKAS 03 IA4.....	565
CHOW 16.....	523	CHPX 32 L.....	429	CIMD 0.5.....	190*	CKAS 03 V.....	564
CHOW 24.....	524	CHPX 32 L29.....	429	CIMD 0.7.....	254	CKAS 03 VA.....	564
CHOW 32.....	525	CHPX 32 LP.....	429	CIO 16.36.....	407	CKAW 03 V.....	512
CHOW 48 L.....	526	CHPX 32 LP29.....	429	CIO 24.36.....	417	CKAW 03 VA.....	512
CHOW 50.....	527	CHPX 32 LS.....	429	CIO 24 YX36.....	613	CKAX 03.....	349
CHP 06 L.....	388	CHPX 32 LS29.....	429	CIPZ D.....	716, 717	CKAX 03 APS.....	349
CHP 06 L2.....	388	CHSDS.....	701	CITP D.....	716	CKAX 03 CX.....	351
CHP 06 LS.....	388	CHV 06 L13.....	389	CIV 16.29.....	407	CKAX 03 CXA.....	351
CHP 06 LS2.....	388	CHV 06 L16.....	389	CIV 24.36.....	417	CKAX 03 I.....	354
CHP 10.....	394	CHV 06 LG.....	390	CIV 24 YX36.....	613	CKAX 03 IA.....	349
CHP 10.2.....	394	CHV 06 LX16.....	391	CIVES.....	717	CKAX 03 IA4.....	356
CHP 10 CP.....	394	CHV 10.....	395	CIVFD 0.1.....	266	CKAX 03 IAPS.....	349
CHP 10 CP2.....	394	CHV 10 G.....	398	CIVFD 0.5.....	266	CKAX 03 ILS.....	350, 354
CHP 10 CS.....	394	CHV 10 L.....	396	CIVMD 0.1.....	266	CKAX 03 ILSA.....	350
CHP 10 CS2.....	394	CHV 10 LG.....	399	CIVMD 0.5.....	266	CKAX 03 VGS.....	351
CHP 10 L.....	394	CHV 10 X.....	400	CIVTP D.....	717	CKAXE 03 I.....	538
CHP 10 L2.....	394	CHV 16.....	404	CJK 8B IFT.....	310	CKAXE 03 IA.....	538
CHP 10 LS.....	394	CHV 16 G.....	408	CJK 8FT.....	308	CKAXR 03 AP.....	583
CHP 10 LS2.....	394	CHV 16 L.....	405	CJK 8IFT.....	310	CKAXR 03 I.....	583
CHP 16.....	403	CHV 16 LG.....	409	CJK 8IMT.....	308, 310	CKAXR 03 IA.....	583
CHP 16.2.....	403	CHV 16 X.....	410	CJK 8M.....	315	CKAXR 03 IAP.....	583
CHP 16 CP.....	403	CHV 24.....	414	CJK 8MT.....	308	CKAXR 03 VG.....	583
CHP 16 CP2.....	403	CHV 24.29.....	414	CJK 8P IFT.....	310	CKAXS 03 AP.....	564
CHP 16 CS.....	403	CHV 24 G.....	419	CJ KF.....	305	CKAXS 03 I.....	564
CHP 16 CS2.....	403	CHV 24 L.....	415	CJ KM.....	305	CKAXS 03 IA.....	564
CHP 16 L.....	403	CHV 24 L29.....	415	CJPW K.....	737	CKAXS 03 IA4.....	565
CHP 16 L2.....	403	CHV 24 LG.....	420	CJPZ T.....	736	CKAXS 03 IAP.....	564
CHP 16 LS.....	403	CHV 24 X.....	422	CJPZ Y.....	735	CKAXS 03 VG.....	564
CHP 16 LS2.....	403	CHV 32.....	426	CJST.....	735, 736	CKAXW 03 AP.....	512
CHP 24.....	413	CHV 32.29.....	426	CJZ 8 IN.....	306	CKAXW 03 I.....	512
CHP 24.2.....	413	CHV 32.42.....	426	CJZA 8 I.....	306	CKAXW 03 IA.....	512
CHP 24 CP.....	413	CHV 32 G.....	426	CK 03 C.....	340	CKAXW 03 IA4.....	513
CHP 24 CP2.....	413	CHV 32 G29.....	426	CK 03 CA.....	340	CKAXW 03 IAP.....	512
CHP 24 CS.....	413	CHV 32 G42.....	426	CK 03 CAN.....	340	CKAXW 03 VG.....	512
CHP 24 CS2.....	413	CHV 32 L.....	426	CK 03 CAS.....	340	CKAXX 03 IA4.....	357
CHP 24 L.....	413	CHV 32 LG.....	426	CK 03 CN.....	340	CKAXXS 03IA4.....	565
CHP 24 L2.....	413	CHV 32 X.....	427	CK 03 CS.....	340	CKAXXW 03IA4.....	513
CHP 24 LS.....	413	CHV 48 L.....	430	CK 03 CX.....	340	CKF 03.....	58, 59
CHP 24 LS2.....	413	CHV 48 L29.....	430	CK 03 CXA.....	340	CKF 03 N.....	58
CHP 32.....	425	CHV 48 L42.....	430	CK 03 CXAN.....	340	CKF 03 RY.....	60-79
CHP 32.2.....	425	CHVR 06 L13.....	586	CK 03 CXN.....	340	CKF 04.....	58

\* These items are also shown in various sections throughout the catalogue



CKF 04 N.....	58	CNEF 24 TN.....	115	CQF 04/2.....	191	CR 42 V.....	680, 681
CKF 04 RY.....	60	CNEF 24 TX.....	113, 115	CQF 05.....	186	CR 50 AD.....	700
CKFD 04.....	59	CNEF 24 TXN.....	115	CQF 07.....	187	CR 50 AD1.....	700
CKG 03 CN.....	346	CNEM 06 RY.....	116, 118	CQF 08.....	192	CR 50 AD2.....	700
CKG 03 VAN.....	347	CNEM 06 T.....	110	CQF 12.....	189, 193	CR 72.....	686
CKG 03 VN.....	347	CNEM 06 TX.....	110	CQF 17.....	193	CR 72 CX.....	686
CKM 03.....	58, 59	CNEM 10 RY.....	117, 119	CQF 21.....	190	CR 72 CX D.....	686
CKM 03 N.....	58	CNEM 10 T.....	111	CQM 04/2.....	191	CR 72 D.....	686
CKM 03 RY.....	60	CNEM 10 TX.....	111	CQM 07.....	187	CRAD.....	669
CKM 03 T1.....	692	CNEM 16 RY.....	118, 148, 150	CQM 08.....	192	CRAS.....	669
CKM 03 T3.....	692	CNEM 16 T.....	112-114	CQM 12.....	189	CR BDE.....	694
CKM 04.....	58, 59	CNEM 16 TN.....	114	CQM 17.....	193	CRBF.....	669
CKM 04 N.....	58	CNEM 16 TX.....	112-114	CQM 21.....	190	CR BLC622.....	616
CKM 04 RY.....	60	CNEM 16 TXN.....	114	CQO 24.....	418	CRBM.....	669
CKR 65.....	339*	CNEM 24 RY.....	119, 120	CQS 08 I.....	573	CR BST.....	695
CKR 65 D.....	339*	CNEM 24 RYN.....	120	CQS 08 IA.....	573	CR CDS.....	86*
CKSHF 03.....	63	CNEM 24 T.....	113, 115	CQS 08 IAP.....	573	CR CLK.....	665
CKSHF 04.....	63	CNEM 24 TN.....	115	CQS 08 V.....	574	CR CP.....	689
CKSHM 03.....	63	CNEM 24 TX.....	113, 115	CQS 08 VA.....	574	CR CPQ.....	689
CKSHM 04.....	63	CNEM 24 TXN.....	115	CQS 08 VG.....	574	CR CX01B.....	371
CKX 03 I.....	344	COB 06 BC.....	652	CQV 24.....	418	CR CX01G.....	371
CKX 03 IA.....	344	COB 06 CMS.....	653	CR 05 CA.....	678-681	CR CX01N.....	371
CKX 03 IAP.....	344	COB 10 BC.....	652	CR 06 AT.....	678	CR CX01R.....	371
CKX 03 IAPS.....	344	COB 10 CMS.....	653	CR 06 BPE.....	510, 655	CRF.....	685, 686
CKX 03 IN.....	344	COB 16 BC.....	652	CR 06 DF.....	601, 682	CRF CX.....	685, 686
CKX 03 VG.....	345	COB 16 CMS.....	653	CR 06 FS.....	680	CRF CX D.....	685, 686
CKX 03 VGS.....	345	COB 24 BC.....	652	CR 06 SC.....	679	CRF D.....	685, 686
CL 125 SC.....	271, 321	COB 24 CMS.....	653	CR 06 ST.....	678	CR GND.....	258*
CLC1.....	730, 732	COB L.....	654	CR 08 EMC.....	575	CRH 24.....	702
CLC4.....	730, 732	COB TCQ.....	652	CR 09 AD.....	700	CRIC M3.....	668
CLDL.....	730	COB TSF.....	653	CR 09 AD1.....	700	CR K03.....	688
CLDL DD.....	732	COB TSFS.....	653	CR 09 AD2.....	700	CR K04G.....	688
CLES.....	730, 734	COPZ.....	734	CR 10 AT.....	678	CR K04R.....	688
CLF DD.....	677	COST.....	734	CR 10 BPE.....	510, 655	CR KC.....	315
CLK 04 SCF.....	321	CPES.....	699	CR 10 CA.....	678-681	CRM.....	685, 686
CLK 04 SCF-H.....	321	CPF 06.....	178	CR 10 DF.....	601, 682	CRM CX.....	685, 686
CLK 04 SCM.....	321	CPF 06 RY.....	178	CR 10 FS.....	680	CRM CX D.....	685, 686
CLM DD.....	677	CPM 06.....	178	CR 10 SC.....	679	CRM D.....	685, 686
CL POF SC.....	271, 321	CPM 06 RY.....	178	CR 10 ST.....	678	CRN 1.....	421
CLPZ R.....	730, 732	CPPZ C.....	720	CR 15/16.....	654	CRN 2.....	421
CLSG.....	730, 732	CPT 24.....	699	CR 15 AD.....	700	CRN 3.....	421
CLSP.....	730, 732	CQ4F 02.....	182	CR 15 AD1.....	700	CRN P.....	421
CLTE.....	730, 732	CQ4F 02 H.....	183	CR 15 AD2.....	700	CR Q02.....	691
CMCEF 03.....	137	CQ4F 03.....	184	CR 16 AT.....	678	CR Q03.....	693
CMCEF 06.....	139, 143	CQ4M 02.....	182	CR 16 BPE.....	510, 655	CR Q12.....	689
CMCEF 06 N.....	143	CQ4M 02 H.....	183	CR 16 DF.....	601, 682	CRQ 16.....	367, 575
CMCEF 10.....	141, 145	CQ4M 03.....	184	CR 16 FS.....	680	CRQ 21.....	367, 575
CMCEF 10 N.....	145	CQ 08 C.....	367	CR 16 SC.....	679	CR QF07.....	690
CMCEM 03.....	137	CQ 08 CA.....	367	CR 16 SS.....	680	CR QM07.....	690
CMCEM 06.....	139, 143	CQ 08 I.....	365	CR 16 SSD.....	681	CR SP.....	680, 681
CMCEM 06 N.....	143	CQ 08 IA.....	365	CR 16 ST.....	678	CR TM-1.....	698
CMCEM 10.....	141, 145	CQ 08 IAP.....	365	CR 20.....	684	CR TT.....	232
CMCEM 10 N.....	145	CQ 08 V.....	366	CR 20 CX.....	684	CR VATG.....	668
CMSHF 03.....	136	CQ 08 VA.....	366	CR 20 CX D.....	684	CR VDTG.....	668
CMSHF 06.....	138	CQ 08 VG.....	367	CR 20 D.....	684	CR VGM4.....	289
CMSHF 06 N.....	142	CQAM 12 T1.....	693	CR 24 AT.....	678	CR VNTG.....	668
CMSHM 03.....	136	CQEEF 40.....	176	CR 24 ATD.....	678	CR VPTG.....	668
CMSHM 06.....	142	CQEEF 64.....	177	CR 24 BPE.....	510, 655	CR YLK24.....	616
CMSHM 06 N.....	142	CQEEM 40.....	176	CR 24 DF.....	601, 682	CR YLK24 SL.....	616
CNEF 06 RY.....	116, 118, 120	CQEEM 64.....	177	CR 24 FS.....	680	CRZ 06.....	702
CNEF 06 T.....	110	CQEF 10.....	168	CR 24 SC.....	679	CRZ 10.....	702
CNEF 06 TX.....	110	CQEF 18.....	169	CR 24 SCA.....	679	CRZ 16.....	702
CNEF 10 RY.....	117, 119	CQEF 32.....	170, 172, 176	CR 24 SS.....	680	CRZ 24.....	702
CNEF 10 T.....	111	CQEF 32 N.....	172	CR 24 SSD.....	681	CSAHF 10.....	99
CNEF 10 TX.....	111	CQEF 46.....	171, 173, 177	CR 24 ST.....	678	CSAHF 16.....	101, 103
CNEF 16 RY.....	118	CQEF 46 N.....	173	CR 25/16.....	654	CSAHF 16 N.....	103
CNEF 16 T.....	112-114	CQEM 10.....	168	CR 25 AD.....	700	CSAHM 10.....	103
CNEF 16 TN.....	114	CQEM 18.....	169	CR 25 AD1.....	700	CSAHM 16.....	101, 103
CNEF 16 TX.....	112-114	CQEM 32.....	170, 172, 176	CR 25 AD2.....	700	CSAHM 16 N.....	103
CNEF 16 TXN.....	114	CQEM 32 N.....	172	CR 26 V.....	680, 681	CSHES.....	738
CNEF 24 RY.....	119, 120	CQEM 46.....	171, 173, 177	CR 37 AD.....	700	CSHF 06.....	110
CNEF 24 RYN.....	120	CQEM 46 N.....	173	CR 37 AD1.....	700	CSHF 06 S.....	122
CNEF 24 T.....	113, 115	CQES.....	708*	CR 37 AD2.....	700	CSHF 10.....	111, 116, 118

\* These items are also shown in various sections throughout the catalogue

CSHF 10 S .....	123	CTSEM 10 R .....	161	CVAV 10 G21 .....	453	CVV 24 LG .....	463
CSHF 16 .....	112, 114, 117, 119	CTSEM 16 L .....	162, 164	CVAV 10 G29 .....	453	CW 0.5 J2M4E .....	278
CSHF 16 N .....	114	CTSEM 16 LN .....	165	CVAV 10 LG21 .....	453	CW 0.5 J2M8 .....	278
CSHF 16 S .....	124, 126	CTSEM 16 R .....	162, 164	CVAV 10 LG29 .....	453	CW 0.5 JM .....	278
CSHF 16 SN .....	126	CTSEM 16 RN .....	164	CVAV 16 G21 .....	458	CW 0.5 JM4/2 .....	278
CSHF 24 .....	113	CTSEM 24 L .....	163, 165	CVAV 16 G29 .....	458	CW 0.5 JM4E .....	278
CSHF 24 N .....	115	CTSEM 24 LN .....	165	CVAV 16 LG21 .....	458	CW 1 J2M87 .....	309
CSHF 24 S .....	125, 127	CTSEM 24 R .....	163, 165	CVAV 16 LG29 .....	458	CW 1 SC9 .....	322
CSHF 24 SN .....	127	CTSEM 24 RN .....	165	CVAV 24 G21 .....	463	CW 1 SC50 .....	322
CSHM 06 .....	110	CTSF 40 L .....	156	CVAV 24 G29 .....	463	CW 1 SC62 .....	322
CSHM 06 S .....	122	CTSF 40 R .....	156	CVAV 24 LG21 .....	463	CW 2 J2M4E .....	278
CSHM 10 .....	111, 116, 118	CTSF 64 L .....	157	CVAV 24 LG29 .....	463	CW 2 J2M8 .....	278
CSHM 10 S .....	123	CTSF 64 R .....	157	CVFV 06 LG21 .....	447	CW 2 J2M87 .....	309
CSHM 16 .....	112, 114, 117, 119	CTSM 40 L .....	156	CVFV 06 LG29 .....	447	CW 2 JM4/2 .....	278
CSHM 16 N .....	114	CTSM 40 R .....	156	CVFV 10 G21 .....	453	CW 2 JM4E .....	278
CSHM 16 S .....	124, 126	CTSM 64 L .....	157	CVFV 10 G29 .....	453	CW 2 JM8 .....	278
CSHM 16 SN .....	126	CTSM 64 R .....	157	CVFV 10 LG21 .....	453	CW 2 SC9 .....	322
CSHM 24 .....	113, 115	CUK 2FT .....	318	CVFV 10 LG29 .....	453	CW 2 SC50 .....	322
CSHM 24 N .....	115	CUK 3FT .....	318	CVFV 16 G21 .....	458	CW 2 SC62 .....	322
CSHM 24 S .....	125, 127	CVAP 06 LP .....	446	CVFV 16 G29 .....	458	CW 2 UAM .....	264, 318
CSHM 24 SN .....	127	CVAP 06 LP2 .....	446	CVFV 16 LG21 .....	458	CW 3 J2M87 .....	309
CSSF 06 .....	148-151	CVAP 06 LP29 .....	446	CVFV 16 LG29 .....	458	CW 3 SC9 .....	322
CSSF 10 .....	149, 151	CVAP 06LP229 .....	446	CVFV 24 G21 .....	463	CW 3 SC50 .....	322
CSSF 16 .....	150, 152	CVAP 06 LS .....	446	CVFV 24 G29 .....	463	CW 3 SC62 .....	322
CSSF 16 N .....	152	CVAP 06 LS2 .....	446	CVFV 24 LG21 .....	463	CW 5 J2M4E .....	278
CSSF 24 .....	151, 153	CVAP 06 LS29 .....	446	CVFV 24 LG29 .....	463	CW 5 J2M8 .....	278
CSSF 24 N .....	153	CVAP 06LS229 .....	446	CVI 06 LP .....	444	CW 5 J2M87 .....	309
CSSM 06 .....	148-151	CVAP 06LSP21 .....	445	CVI 06 LS .....	444	CW 5 JM4/2 .....	278
CSSM 10 .....	149, 151	CVAP 06LSP29 .....	445	CVI 06 LSP .....	445	CW 5 JM4E .....	278
CSSM 16 .....	150, 152	CVAP 10 L21 .....	451	CVI 10 L .....	448	CW 5 JM8 .....	278
CSSM 16 N .....	152	CVAP 10 L29 .....	451	CVI 10 LA .....	450	CW 5 SC9 .....	322
CSSM 24 .....	151, 153	CVAP 10 L221 .....	451	CVI 10 LP .....	448	CW 5 SC50 .....	322
CSSM 24 N .....	153	CVAP 10 L229 .....	451	CVI 10 LS .....	448	CW 5 SC62 .....	322
CTAPE .....	669	CVAP 10 LP21 .....	452	CVI 10 LSP .....	449	CW 7.5J2M87 .....	309
CTF 06 L .....	160	CVAP 10 LP29 .....	452	CVI 16 L .....	454	CW 10 J2M4E .....	278
CTF 06 R .....	160	CVAP 10LP221 .....	452	CVI 16 LP .....	454	CW 10 J2M8 .....	278
CTF 10 L .....	161	CVAP 10LP229 .....	452	CVI 16 LS .....	454	CW 10 J2M87 .....	309
CTF 10 R .....	161	CVAP 10 LS .....	452	CVI 16 LSP .....	455	CW 10 JM4/2 .....	278
CTF 16 L .....	162	CVAP 10 LS2 .....	452	CVI 24 L .....	459	CW 10 JM4E .....	278
CTF 16 R .....	162	CVAP 10 LS29 .....	452	CVI 24 LP .....	459	CW 10 JM8 .....	278
CTF 24 L .....	163	CVAP 10LS229 .....	452	CVI 24 LS .....	459	CW 10 SC9 .....	322
CTF 24 R .....	163	CVAP 10LSP21 .....	449	CVI 24 LSP .....	460	CW 10 SC50 .....	322
CTF 40 L .....	156	CVAP 10LSP29 .....	449	CVP 06 LP .....	446	CW 10 SC62 .....	322
CTF 40 R .....	156	CVAP 16 L21 .....	456	CVP 06 LP2 .....	446	CW 15 J2M87 .....	309
CTF 64 L .....	157	CVAP 16 L22 .....	456	CVP 06 LS .....	446	CWC J5 1M .....	312
CTF 64 R .....	157	CVAP 16 L29 .....	456	CVP 06 LS2 .....	446	CWC J5 2M .....	312
CTM 06 L .....	160	CVAP 16 L229 .....	456	CVP 06 LSP16 .....	445	CWC J5 3M .....	312
CTM 06 R .....	160	CVAP 16 LP21 .....	457	CVP 10 L .....	451	CWC J5 5M .....	312
CTM 10 L .....	161	CVAP 16 LP29 .....	457	CVP 10 L2 .....	451	CWC J5 7.5M .....	312
CTM 10 R .....	161	CVAP 16LP221 .....	457	CVP 10 LP .....	452	CWC J5 10M .....	312
CTM 16 L .....	162	CVAP 16LP229 .....	457	CVP 10 LS .....	452	CWC J5 15M .....	312
CTM 16 R .....	162	CVAP 16 LS .....	457	CVP 10 LS2 .....	452	CWC J6 1M .....	311
CTM 24 L .....	163	CVAP 16 LS2 .....	457	CVP 10 LSP16 .....	449	CWC J6 2M .....	311
CTM 24 R .....	163	CVAP 16 LS29 .....	457	CVP 16 L .....	456	CWC J6 3M .....	311
CTM 40 L .....	156	CVAP 16LS229 .....	457	CVP 16 L2 .....	456	CWC J6 5M .....	311
CTM 40 R .....	156	CVAP 16LSP21 .....	455	CVP 16 LP .....	457	CWC J6 7.5M .....	311
CTM 64 L .....	157	CVAP 16LSP29 .....	455	CVP 16 LP2 .....	457	CWC J6 10M .....	311
CTM 64 R .....	157	CVAP 24 L21 .....	461	CVP 16 LS .....	457	CWC J6 15M .....	311
CTSEF 06 L .....	160	CVAP 24 L29 .....	461	CVP 16 LS2 .....	457	CWH J6 0.5M .....	313
CTSEF 06 R .....	160	CVAP 24 L221 .....	461	CVP 16 LSP21 .....	455	CWH J6 0.5MA .....	313
CTSEF 10 L .....	161	CVAP 24 L229 .....	461	CVP 24 L .....	461	CWH J6 0.25M .....	313
CTSEF 10 R .....	161	CVAP 24 LP21 .....	462	CVP 24 L2 .....	461	CWH J6 1M .....	313
CTSEF 16 L .....	162, 164	CVAP 24 LP29 .....	462	CVP 24 LP .....	462	CWH J6 1MA .....	313
CTSEF 16 LN .....	164	CVAP 24LP221 .....	462	CVP 24 LP2 .....	462	CWH J6 2M .....	313
CTSEF 16 R .....	162, 164	CVAP 24LP229 .....	462	CVP 24 LS .....	462	CWH J6 2MA .....	313
CTSEF 16 RN .....	164	CVAP 24 LS .....	462	CVP 24 LS2 .....	462	CWH J6 3M .....	313
CTSEF 24 L .....	163, 165	CVAP 24 LS2 .....	462	CVP 24 LSP21 .....	460	CWH J6 3MA .....	313
CTSEF 24 LN .....	165	CVAP 24 LS29 .....	462	CVV 06 LG .....	447	CWH J6 5M .....	313
CTSEF 24 R .....	163, 165	CVAP 24LS229 .....	462	CVV 10 G .....	453	CWH J6 5MA .....	313
CTSEF 24 RN .....	165	CVAP 24LSP21 .....	460	CVV 10 LG .....	453	CWH J6 7.5M .....	313
CTSEM 06 L .....	160	CVAP 24LSP29 .....	460	CVV 16 G .....	458	CWH J6 7.5MA .....	313
CTSEM 06 R .....	160	CVAV 06 LG21 .....	447	CVV 16 LG .....	458	CWH J6 10M .....	313
CTSEM 10 L .....	161	CVAV 06 LG29 .....	447	CVV 24 G .....	463	CWH J6 10MA .....	313

\* These items are also shown in various sections throughout the catalogue



CWH J6 15M.....	313
CWH JE 0.5M.....	313
CWH JE 1M.....	313
CWH JE 2M.....	313
CWH JE 3M.....	313
CWH JE 5M.....	313
CWH JE 7.5M.....	313
CWH JE 10M.....	313
CWH JE 15M.....	313
CW J5 1M.....	312
CW J5 2M.....	312
CW J5 3M.....	312
CW J5 5M.....	312
CW J5 7.5M.....	312
CW J5 10M.....	312
CW J5 15M.....	312
CW J6 1M.....	311
CW J6 2M.....	311
CW J6 3M.....	311
CW J6 5M.....	311
CW J6 7.5M.....	311
CW J6 10M.....	311
CW J6 15M.....	311
CWK 2 J2M8.....	306
CWK 5 J2M8.....	306
CWK 10 J2M8.....	306
CWKA 2 J2M8.....	306
CWKA 5 J2M8.....	306
CWKA 10J2M8.....	306
CW XJ0.5M.....	311
CW XJ1M.....	311
CW XJ2M.....	311
CW XJ3M.....	311
CW XJ5M.....	311
CW XJ7.5M.....	311
CW XJ10M.....	311
CX 1/2 BDF.....	325
CX 1/2 BDM.....	325
CX 1.6 PF.....	283
CX 1.6 PM.....	283
CX 1.6 VC.....	283
CX 01 9VF.....	266
CX 01 9VM.....	266, 268
CX 01 9VTF.....	268
CX 01 BCF.....	259
CX 01 BCM.....	259
CX 01 BF.....	261
CX 01 BM.....	261
CX 01 GF.....	234
CX 01 GM.....	234
CX 01 J8F.....	272
CX 01 J8IM.....	272
CX 01 J8M.....	272
CX 01 JF.....	274
CX 01 JM.....	274
CX 01 T.....	286
CX 01 UF.....	264
CX 01 UM.....	264
CX 01 YF.....	232
CX 01 YM.....	232
CX 01 YPEF.....	233
CX 01 YPEM.....	233
CX 02 4AF.....	238
CX 02 4AM.....	238
CX 02 4BF.....	238
CX 02 4BM.....	238
CX 02 4F.....	237, 291
CX 02 4M.....	237, 291
CX 02 7F.....	236
CX 02 7M.....	236
CX 02 BF.....	258, 260, 262
CX 02 BM.....	258, 260, 262
CX 02 CHF.....	249

CX 02 CHM.....	249
CX 02 GF.....	235
CX 02 GM.....	235
CX 02 HF.....	250
CX 02 HM.....	250
CX 02 JF.....	276
CX 02 JM.....	276
CX 02 P.....	282
CX 02 TF.....	287
CX 02 TM.....	287
CX 3.0 PF.....	283
CX 3.0 PM.....	283
CX 3.0 VC.....	283
CX 03 4BF.....	240, 293
CX 03 4BM.....	240, 293
CX 03 4F.....	239, 292
CX 03 4M.....	239, 292
CX 3/4 XDF.....	241, 294
CX 3/4 XDM.....	241, 294
CX 03 P.....	282
CX 03 TF.....	287
CX 03 TM.....	287
CX 4.0 PF.....	283
CX 4.0 PM.....	283
CX 4.0 VC.....	283
CX 4/2 JM.....	274, 276
CX 04 BF.....	261
CX 04 BM.....	261
CX 4E JM.....	274, 276
CX 4 JM.....	274, 276
CX 04 LF.....	269
CX 04 LM.....	269, 270
CX 04 RF.....	270
CX 04 RM.....	270
CX 04 SCF.....	271
CX 04 SCF-H.....	271
CX 04 SCM.....	271
CX 04 TF.....	287
CX 04 TM.....	287
CX 04 XF.....	242, 295
CX 04 XM.....	242, 295
CX 5/7 CA.....	256
CX 05 SF.....	243
CX 05 SHF.....	244
CX 05 SHM.....	244
CX 05 SM.....	243
CX 6.0 PF.....	283
CX 6.0 PM.....	283
CX 6.0 VC.....	283
CX 6/2 JM.....	274, 276
CX 06 CF.....	245, 297
CX 06 CM.....	245, 297
CX 06P CF.....	246, 296
CX 06P CM.....	246, 296
CX 06 TF.....	287
CX 06 TM.....	287
CX 7/10 CA.....	256
CX7FA 10.....	236
CX7FA 16.....	236
CX7FA 25.....	236
CX7MA 10.....	236
CX7MA 16.....	236
CX7MA 25.....	236
CX7PZ LOC.....	720
CX 8/2 JF.....	274, 276
CX 08 BF.....	263
CX 08 BM.....	263
CX 08 CF.....	247, 298
CX 08 CM.....	247, 298
CX 08 I6F.....	256
CX 08 I6M.....	256
CX 8 J6IM.....	272, 308, 310
CX 8 J6M.....	272, 308

CX 8 JF.....	274, 276
CX 8 JM.....	274, 276
CX 10/12 CA.....	256
CX 12 DF.....	251, 300
CX 12 DM.....	251, 300
CX 17 DF.....	252, 301
CX 17 DM.....	252, 301
CX 20 CF.....	248, 299
CX 20 CM.....	248, 299
CX 25 IBF.....	254
CX 25 IBM.....	254
CX 25 IF.....	255
CX 25 IM.....	255
CX 42 DF.....	253, 302
CX 42 DM.....	253, 302
CX 50 RF.....	270
CX 50 RM.....	270
CX 75 RF.....	270
CX 75 RM.....	270
CXA 01 I.....	369
CX BES.....	703
CX CFM.....	287, 303
CXES.....	711*
CXES-10.....	714
CXF 4/0.....	200
CXF 4/0 RY.....	202
CXF 4/2.....	201
CXF 4/2 RY.....	203
CXF 4/8.....	204
CXF 4/8 RY.....	204
CXF 6/6.....	206
CXF 6/12.....	197
CXF 6/36.....	198
CXF 8/24.....	194
CXF 12/2.....	199
CXFA 1.5.....	182*
CXFA 2.5.....	182*
CXFA 4.0.....	182*
CXFA 6.0.....	182*
CXFA 10.....	182*
CXFFA.....	672
CX FM.....	279
CXL 2/4 PF.....	333
CXL 2/4 PFH.....	333
CXL 2/4 PM.....	333
CXL 2/4 PMH.....	333
CXL 2/4 SF.....	332
CXL 2/4 SM.....	332
CXL PF.....	333
CXL PM.....	333
CXL SF.....	332
CXL SM.....	332
CXM 4/0.....	200
CXM 4/0 RY.....	202
CXM 4/2.....	201
CXM 4/2 RY.....	203
CXM 4/8.....	204
CXM 4/8 RM.....	204
CXM 6/6.....	206
CXM 6/12.....	197
CXM 6/36.....	198
CXM 8/24.....	194
CXM 12/2.....	199
CXMA 1.5.....	182*
CXMA 2.5.....	182*
CXMA 4.0.....	182*
CXMA 6.0.....	182*
CXMA 10.....	182*
CXMFA.....	672
CX MLF.....	269
CX MLM.....	269
CXP 01 C.....	370
CXP 01 CLG.....	370

CX PLF.....	269
CX PLM.....	269
CXPNP.....	712
CXPNPP.....	726
CXPZ D.....	712
CXPZP D.....	726
CXPZ TP.....	711
CXTP 40.....	712, 726
CYD 35 C.....	720
CYD 50 C.....	720
CYD 70 C.....	720
CYFA 16.....	232, 233
CYFA 25.....	232, 233
CYFA 35.....	232, 233
CYFA 50.....	232, 233
CYFA 70.....	232, 233
CYG 06H06.....	666
CYG 06H06D.....	666
CYG 06H10.....	666
CYG 06H10D.....	666
CYG 06H0606.....	667
CYG 06H0610.....	667
CYG 06H1006.....	667
CYG 06H1010.....	667
CYG 8/2 JF.....	307
CYG 8/2 JFA.....	307
CYG 8 JF.....	307
CYG 8 JFA.....	307
CYG 16.....	659
CYMA 16.....	232, 233
CYMA 25.....	232, 233
CYMA 35.....	232, 233
CYMA 50.....	232, 233
CYMA 70.....	232, 233
CYPZ LOC.....	720
CYR 16.3.....	658
CYR 24.4.....	658
CZ7CE 15 LG.....	540
CZ7CE 25 LG.....	541
CZ7CS 15 LG.....	576
CZ7CS 25 LG.....	577
CZ7CW 15 LG.....	519
CZ7CW 25 LG.....	520
CZ7I 15 L.....	384
CZ7I 15 LS.....	384
CZ7I 25 L.....	385
CZ7I 25 LS.....	385
CZ7IE 15 L.....	540
CZ7IE 25 L.....	541
CZ7IS 15 L.....	576
CZ7IS 25 L.....	577
CZ7IW 15 L.....	519
CZ7IW 25 L.....	520
CZ7PS 15 L2.....	576
CZ7PS 25 L2.....	577
CZ7PW 15 L2.....	519
CZ7PW 25 L2.....	520
CZAC 15 L.....	382
CZAC 25 L.....	382
CZAO 15 L16.....	376
CZAO 15 L21.....	376
CZAO 25 L16.....	380
CZAO 25 L21.....	380
CZAO 15 L21.....	519
CZAO 25 L21.....	520
CZAP 25 L.....	378
CZAP 25 L2.....	378
CZAP 25 L21.....	378
CZAP 25 L221.....	378
CZAP 25 LS.....	378
CZAP 25 LS2.....	378
CZAP 25 LS21.....	378
CZAP 25LS221.....	378

\* These items are also shown in various sections throughout the catalogue

CZAP 25LSP16.....	379	M7AP 06 L232.....	436	MAO 16.32.....	404	MAP 10 LS40.....	394
CZAP 25LSP21.....	379	M7AP 06 L240.....	436	MAO 16.40.....	404	MAP 10 LS232.....	394
CZAPR 06 L.....	586	M7AP 06 LS32.....	437	MAO 16 L32.....	405	MAP 10 LS240.....	394
CZAV 15 L16.....	376	M7AP 06 LS40.....	437	MAO 16 L40.....	405	MAP 10 YC232.....	606
CZAV 15 L21.....	376	M7AP 06LS232.....	437	MAO 16 X32.....	410	MAP 16.25.....	403
CZAV 25 L16.....	380	M7AP 06LS240.....	437	MAO 16 X40.....	410	MAP 16.32.....	403
CZAV 25 L21.....	380	M7AP 10.32.....	438	MAO 16 YX32.....	610	MAP 16.40.....	403
CZAV 25 L216.....	380	M7AP 10.40.....	438	MAO 16 YX40.....	610	MAP 16.225.....	403
CZAVW 15 L21.....	519	M7AP 10.232.....	438	MAO 24.32.....	414	MAP 16.232.....	403
CZAVW 25 L21.....	520	M7AP 10.240.....	438	MAO 24.40.....	414	MAP 16.240.....	403
CZC 15 L.....	377	M7AP 16.32.....	439	MAO 24 L32.....	415	MAP 16 CP32.....	403
CZC 15 LG.....	377	M7AP 16.40.....	439	MAO 24 L40.....	415	MAP 16 CP40.....	403
CZC 15 SL.....	377	M7AP 16.232.....	439	MAO 24 X32.....	422	MAP 16 CP232.....	403
CZC 25 L.....	381	M7AP 16.240.....	439	MAO 24 X40.....	422	MAP 16 CP240.....	403
CZC 25 LG.....	381	M7AP 16 S32.....	440	MAO 24 YX32.....	613	MAP 16 CS32.....	403
CZC 25 SL.....	381	M7AP 16 S232.....	440	MAO 24 YX40.....	613	MAP 16 CS40.....	403
CZCE 15 L.....	540	M7AP 24.32.....	441	MAO 50.25.....	432	MAP 16 CS232.....	403
CZCE 25 L.....	541	M7AP 24.40.....	441	MAO 50.32.....	432	MAP 16 CS240.....	403
CZCR 06 LG.....	586	M7AP 24.232.....	441	MAO 50 X25.....	433	MAP 16 L32.....	403
CZCS 15 L.....	576	M7AP 24.240.....	441	MAO 50 X32.....	433	MAP 16 L40.....	403
CZCS 25 L.....	577	M7AP 24 S32.....	442	MAOE 06 L32.....	542	MAP 16 L232.....	403
CZCW 15 L.....	519	M7AP 24 S232.....	442	MAOE 10.32.....	543	MAP 16 L240.....	403
CZCW 25 L.....	520	M7APE 06 L32.....	530	MAOE 16.32.....	544	MAP 16 LS32.....	403
CZFO 15 L16.....	376	M7APE 06 L40.....	530	MAOE 16.40.....	544	MAP 16 LS40.....	403
CZFO 15 L21.....	376	M7APE 06L232.....	530	MAOE 24.32.....	545	MAP 16 LS232.....	403
CZFO 25 L16.....	380	M7APE 06L240.....	530	MAOE 24.40.....	545	MAP 16 LS240.....	403
CZFO 25 L21.....	380	M7APE 10.32.....	532	MAOE 50.320.....	548	MAP 16 YC232.....	609
CZFOS 15 L21.....	576	M7APE 10.40.....	532	MAOR 06 L32.....	586	MAP 24.25.....	413
CZFOS 25 L21.....	577	M7APE 10.232.....	532	MAOR 10.32.....	587	MAP 24.32.....	413
CZFB 15 L16.....	376	M7APE 10.240.....	532	MAOR 16.40.....	588	MAP 24.40.....	413
CZFB 15 L21.....	376	M7APE 16.32.....	534	MAOR 24.40.....	589	MAP 24.225.....	413
CZFB 25 L16.....	380	M7APE 16.40.....	534	MAOS 10.32.....	579	MAP 24.232.....	413
CZFB 25 L21.....	380	M7APE 16.232.....	534	MAOS 16.32.....	580	MAP 24.240.....	413
CZFB 25 L216.....	380	M7APE 16.240.....	534	MAOS 16.40.....	580	MAP 24 CP32.....	413
CZFVS 15L221.....	576	M7APE 24.32.....	536	MAOS 24.32.....	581	MAP 24 CP40.....	413
CZFVS 25 L21.....	577	M7APE 24.40.....	536	MAOS 24.40.....	581	MAP 24 CP232.....	413
CZI 15 L.....	374	M7APE 24.232.....	536	MAOS 24.40.....	581	MAP 24 CP240.....	413
CZI 15 LS.....	374	M7APE 24.240.....	536	MAOW 06 L32.....	521	MAP 24 CS32.....	413
CZI 15 LSP.....	375	M7P 06 L20.....	436, 530	MAOW 10.32.....	522	MAP 24 CS40.....	413
CZI 25 L.....	378	M7P 06 L220.....	436	MAOW 16.32.....	523	MAP 24 CS232.....	413
CZI 25 LS.....	378	M7P 06 LS20.....	437	MAOW 16.40.....	523	MAP 24 CS240.....	413
CZI 25 LSP.....	379	M7P 06 LS220.....	437	MAOW 24.32.....	524	MAP 24 L32.....	413
CZIR 06 L.....	586	M7P 10.20.....	438	MAOW 24.40.....	524	MAP 24 L40.....	413
CZO 15 L.....	376	M7P 10.220.....	438	MAOW 50.32.....	527	MAP 24 L232.....	413
CZO 25 L.....	380	M7P 16.25.....	439	MAP 06 L25.....	388	MAP 24 L240.....	413
CZOS 15 L.....	576	M7P 16.225.....	439	MAP 06 L32.....	388	MAP 24 L240.....	413
CZOS 25 L.....	577	M7P 24.25.....	441	MAP 06 L40.....	388	MAP 24 LS32.....	413
CZOW 15 L.....	519	M7P 24.225.....	441	MAP 06 L225.....	388	MAP 24 LS40.....	413
CZOW 25 L.....	520	M7PE 06 L220.....	530	MAP 06 L232.....	388	MAP 24 LS232.....	413
CZP 15 L.....	374	M7PE 10.20.....	532	MAP 06 L240.....	388	MAP 24 LS240.....	413
CZP 15 L2.....	374	M7PE 10.220.....	532	MAP 06 LS32.....	388	MAP 24 YC232.....	612
CZP 15 L21.....	374	M7PE 10.220.....	532	MAP 06 LS40.....	388	MAPE 06 L32.....	542
CZP 15 L21.....	374	M7PE 16.25.....	534	MAP 06 LS232.....	388	MAPE 10.32.....	543
CZP 15 LS.....	374	M7PE 16.225.....	534	MAP 06 LS240.....	388	MAPE 16.32.....	544
CZP 15 LS2.....	374	M7PE 24.25.....	536	MAP 06 YC232.....	603	MAPE 24.32.....	545
CZP 15 LS21.....	374	M7PE 24.225.....	536	MAP 10.25.....	394	MAPN 06 L32.....	618
CZP 15 LS221.....	374	MAF 10.20.....	395	MAP 10.32.....	394	MAPN 10.32.....	620
CZP 15 LSP16.....	375	MAF 16.25.....	404	MAP 10.40.....	394	MAPN 16.32.....	622
CZP 15 LSP21.....	375	MAF 16.225.....	406	MAP 10.225.....	394	MAPN 24.32.....	624
CZPR 06 L.....	586	MAF 24.25.....	414	MAP 10.232.....	394	MAPR 10.32.....	587
CZV 15 L.....	376	MAF 24.32.....	414	MAP 10.240.....	394	MAPR 16.32.....	588
CZV 15 LG.....	376	MAF 24.225.....	416	MAP 10 CP32.....	394	MAPR 24.32.....	589
CZV 25 L.....	380	MAO 06 L25.....	389	MAP 10 CP40.....	394	MAPS 06 L32.....	578
CZV 25 LG.....	381	MAO 06 L32.....	389	MAP 10 CP232.....	394	MAPS 10.32.....	579
CZVS 15 L.....	576	MAO 06 YX25.....	604	MAP 10 CP240.....	394	MAPS 16.32.....	580
CZVS 25 L.....	577	MAO 06 YX32.....	604	MAP 10 CS32.....	394	MAPS 24.32.....	581
CZVW 15 L.....	519	MAO 10.32.....	395	MAP 10 CS40.....	394	MAPW 06 L32.....	521
CZVW 25 L.....	520	MAO 10.40.....	395	MAP 10 CS232.....	394	MAPW 10.32.....	522
		MAO 10 L32.....	396	MAP 10 CS240.....	394	MAPW 24.32.....	524
		MAO 10 L40.....	396	MAP 10 L32.....	394	MAV 06 GYC25.....	605
		MAO 10 X32.....	400	MAP 10 L40.....	394	MAV 06 GYC32.....	605
		MAO 10 X40.....	400	MAP 10 L232.....	394	MAV 06 GYC40.....	605
		MAO 10 YX32.....	607	MAP 10 L240.....	394	MAV 06 L25.....	389
		MAO 10 YX40.....	607	MAP 10 LS32.....	394	MAV 06 L32.....	389
M7AP 06 L32.....	436						
M7AP 06 L40.....	436						

## M

M7AP 06 L32.....	436
M7AP 06 L40.....	436

\* These items are also shown in various sections throughout the catalogue

MAV 06 LG25.....	390	MAVE 50.32.....	548	MFO 16 L40.....	405	MFV 24 G25.....	419
MAV 06LG25-F.....	388	MAVR 06 L32.....	586	MFO 16 LG40.....	409	MFV 24 G32.....	419
MAV 06 LG32.....	390	MAVR 10.32.....	587	MFO 24.32.....	414	MFV 24 G40.....	419
MAV 06 YX25.....	604	MAVR 16.40.....	588	MFO 24.40.....	414	MFV 24 GYC25.....	614
MAV 06 YX32.....	604	MAVR 24.40.....	589	MFO 24 G40.....	419	MFV 24 GYC32.....	614
MAV 10.32.....	395	MAVS 10.32.....	579	MFO 24 L32.....	415	MFV 24 GYC40.....	614
MAV 10.40.....	395	MAVS 16.32.....	580	MFO 24 L40.....	415	MFV 24 L32.....	415
MAV 10.220.....	397	MAVS 16.40.....	580	MFO 24 LG40.....	420	MFV 24 L40.....	415
MAV 10 G25.....	398	MAVS 24.32.....	581	MFO 32.32.....	426	MFV 24 LG25.....	420
MAV 10 G32.....	398	MAVS 24.40.....	581	MFO 32.40.....	426	MFV 24 LG32.....	420
MAV 10 GYC25.....	608	MAVW 06 L32.....	521	MFO 32.50.....	426	MFV 24 LG40.....	420
MAV 10 GYC32.....	608	MAVW 06 LG32.....	521	MFO 32 L40.....	426	MFV 32.32.....	426
MAV 10 GYC40.....	608	MAVW 10.32.....	522	MFO 32 X40.....	427	MFV 32.40.....	426
MAV 10 L32.....	396	MAVW 10 G32.....	522	MFO 48 L32.....	430	MFV 32.50.....	426
MAV 10 L40.....	396	MAVW 16.32.....	523	MFO 48 L40.....	430	MFV 32 G32.....	426
MAV 10 LG25.....	399	MAVW 16.40.....	523	MFO 48 L50.....	430	MFV 32 G40.....	426
MAV 10 LG32.....	399	MAVW 16 G32.....	523	MFO 50.25.....	432	MFV 32 G50.....	426
MAV 10 X32.....	400	MAVW 24.32.....	524	MFO 50.32.....	432	MFV 32 L40.....	426
MAV 10 X40.....	400	MAVW 24.40.....	524	MFO 50 X25.....	433	MFV 32 LG40.....	426
MAV 10 YX32.....	607	MAVW 50.32.....	527	MFO 50 X32.....	433	MFV 32 X40.....	427
MAV 10 YX40.....	607	MBO 06 L40.....	466	MFOE 06 L32M.....	531	MFV 48 L32.....	430
MAV 16.32.....	404	MBO 06 L50.....	466	MFOE 06 L40M.....	531	MFV 48 L40.....	430
MAV 16.40.....	404	MBO 10.40.....	468	MFOE 10.40M.....	533	MFV 48 L50.....	430
MAV 16.220.....	406	MBO 10.50.....	468	MFOE 16.32M.....	535	MFV 50.25.....	432
MAV 16.225.....	406	MBO 16.40.....	470	MFOE 16.40M.....	535	MFV 50.32.....	432
MAV 16 G25.....	408	MBO 16.50.....	470	MFOE 24.32M.....	537	MFV 50 G32.....	432
MAV 16 G32.....	408	MBO 16.225.....	471	MFOE 24.40M.....	537	MFV 50 X25.....	433
MAV 16 G40.....	408	MBO 24.40.....	472	MFON 06 L25.....	618	MFV 50 X32.....	433
MAV 16 GYC25.....	611	MBO 24.50.....	472	MFON 10.32.....	620	MFVE 06 L32M.....	531
MAV 16 GYC32.....	611	MBO 24.225.....	473	MFON 16.32.....	622	MFVE 06 L40M.....	531
MAV 16 GYC40.....	611	MBV 06 L40.....	466	MFON 24.32.....	624	MFVE 10.32M.....	533
MAV 16 L32.....	405	MBV 06 L50.....	466	MFOS 06 L32.....	578	MFVE 10.40M.....	533
MAV 16 L40.....	405	MBV 06 L225.....	466	MFV 06 GYC25.....	605	MFVE 16.32M.....	535
MAV 16 LG25.....	409	MBV 06 L320.....	466	MFV 06 GYC32.....	605	MFVE 24.32M.....	537
MAV 16 LG32.....	409	MBV 10.40.....	468	MFV 06 GYC40.....	605	MFVE 24.40M.....	537
MAV 16 LG40.....	409	MBV 10.50.....	468	MFV 06 L25.....	389	MFVN 06 L25.....	618
MAV 16 X32.....	410	MBV 10.225.....	468	MFV 06 L32.....	389	MFVN 06 LG25.....	619
MAV 16 X40.....	410	MBV 10.420.....	468	MFV 06 L40.....	389	MFVN 10.32.....	620
MAV 16 YX32.....	610	MBV 16.40.....	470	MFV 06 LG25.....	390	MFVN 10 G32.....	621
MAV 16 YX40.....	610	MBV 16.50.....	470	MFV 06 LG32.....	390	MFVN 10 G220.....	621
MAV 24.32.....	414	MBV 16.232.....	470	MFV 06 LG40.....	390	MFVN 16.32.....	622
MAV 24.40.....	414	MBV 16.325.....	470	MFV 10.32.....	395	MFVN 16 G32.....	623
MAV 24.232.....	416	MBV 16.620.....	471	MFV 10.40.....	395	MFVN 16 G225.....	623
MAV 24 G25.....	419	MBV 24.40.....	472	MFV 10.220.....	397	MFVN 24.32.....	624
MAV 24 G32.....	419	MBV 24.50.....	472	MFV 10 G25.....	398	MFVN 24 G32.....	625
MAV 24 G40.....	419	MBV 24.240.....	472	MFV 10 G32.....	398	MFVN 24 G232.....	625
MAV 24 GYC25.....	614	MBV 24.332.....	472	MFV 10 G40.....	398	MFVS 06 L32.....	578
MAV 24 GYC32.....	614	MBV 24.425.....	473	MFV 10 GYC25.....	608	MGK IAP20.....	628
MAV 24 GYC40.....	614	MBV 24.720.....	473	MFV 10 GYC32.....	608	MGK V20.....	629
MAV 24 L32.....	415	MBVO 06 L240.....	467	MFV 10 GYC40.....	608	MGK V20 B.....	631
MAV 24 L40.....	415	MBVO 10.240.....	469	MFV 10 L32.....	396	MGK V25.....	629
MAV 24 LG25.....	420	MBVO 16.240.....	471	MFV 10 L40.....	396	MGK V25 B.....	631
MAV 24 LG32.....	420	MBVO 24.250.....	473	MFV 10 LG25.....	399	MGO 06.25.....	633
MAV 24 LG40.....	420	MFF 10.20.....	395	MFV 10 LG32.....	399	MGO 06.25 B.....	635
MAV 24 X32.....	422	MFF 16.25.....	404	MFV 10 LG40.....	399	MGO 06.32.....	633
MAV 24 X40.....	422	MFF 16.225.....	406	MFV 16.32.....	404	MGO 06.32 B.....	635
MAV 24 YX32.....	613	MFF 24.25.....	414	MFV 16.40.....	404	MGO 10.25.....	637
MAV 24 YX40.....	613	MFF 24.32.....	414	MFV 16.220.....	406	MGO 10.25 B.....	639
MAV 50.25.....	432	MFF 24.225.....	416	MFV 16.225.....	406	MGO 10.32.....	637
MAV 50.32.....	432	MFO 06 L25.....	389	MFV 16 G25.....	408	MGO 10.32 B.....	639
MAV 50 G32.....	432	MFO 06 L32.....	389	MFV 16 G32.....	408	MGO 16.32.....	641
MAV 50 X25.....	433	MFO 06 L40.....	389	MFV 16 G40.....	408	MGO 16.32 B.....	643
MAV 50 X32.....	433	MFO 06 LG40.....	390	MFV 16 GYC25.....	611	MGO 16.40.....	641
MAVE 06 L32.....	542	MFO 10.32.....	395	MFV 16 GYC32.....	611	MGO 16.40 B.....	643
MAVE 06 LG32.....	542	MFO 10.40.....	395	MFV 16 GYC40.....	611	MGO 16.50.....	641
MAVE 10.32.....	543	MFO 10 G40.....	398	MFV 16 L32.....	405	MGO 16.50 B.....	643
MAVE 10 G32.....	543	MFO 10 L32.....	396	MFV 16 L40.....	405	MGO 24.32 B.....	647
MAVE 16.32.....	544	MFO 10 L40.....	396	MFV 16 LG25.....	409	MGO 24.40 B.....	647
MAVE 16.40.....	544	MFO 10 LG40.....	399	MFV 16 LG32.....	409	MGO 24.50 B.....	647
MAVE 16 G32.....	544	MFO 16.32.....	404	MFV 16 LG40.....	409	MGOE 06.25.....	551
MAVE 24.32.....	545	MFO 16.40.....	404	MFV 24.32.....	414	MGOE 06.32.....	551
MAVE 24.40.....	545	MFO 16 G40.....	408	MFV 24.40.....	414	MGOE 10.25.....	553
MAVE 24 G32.....	545	MFO 16 L32.....	405	MFV 24.232.....	416	MGOE 10.32.....	553

\* These items are also shown in various sections throughout the catalogue

MGOE 16.32.....	555	MHO 16 L25.....	405	MHP 16.25.....	403	MHV 16 LG32.....	409
MGOE 16.40.....	555	MHO 16 L32.....	405	MHP 16.225.....	403	MHV 16 X25.....	410
MGOE 16.50.....	555	MHO 16 X25.....	410	MHP 16 CP25.....	403	MHV 16 X32.....	410
MGOE 24.32.....	557	MHO 16 X32.....	410	MHP 16 CP225.....	403	MHV 24.25.....	414
MGOE 24.40.....	557	MHO 24.25.....	414	MHP 16 CS25.....	403	MHV 24.32.....	414
MGOE 24.50.....	557	MHO 24.32.....	414	MHP 16 CS225.....	403	MHV 24.40.....	414
MGP 06.32.....	632	MHO 24 L25.....	415	MHP 16 L25.....	403	MHV 24 G32.....	419
MGP 10.32.....	636	MHO 24 L32.....	415	MHP 16 L225.....	403	MHV 24 L25.....	415
MGP 16.40.....	640	MHO 24 X25.....	422	MHP 16 LS25.....	403	MHV 24 L32.....	415
MGP 24.40.....	644	MHO 24 X32.....	422	MHP 16 LS225.....	403	MHV 24 L40.....	415
MGP 24.240.....	644	MHO 32.32.....	426	MHP 24.25.....	413	MHV 24 LG32.....	420
MGPE 06.32.....	550	MHO 32.40.....	426	MHP 24.225.....	413	MHV 24 X25.....	422
MGPE 10.32.....	552	MHO 32.50.....	426	MHP 24 CP25.....	413	MHV 24 X32.....	422
MGPE 16.40.....	554	MHO 32 L40.....	426	MHP 24 CP225.....	413	MHV 32.32.....	426
MGPE 24.40.....	556	MHO 32 X40.....	427	MHP 24 CS25.....	413	MHV 32.40.....	426
MGPE 24.240.....	556	MHO 48 L32.....	430	MHP 24 CS225.....	413	MHV 32.50.....	426
MGV 06.25.....	633	MHO 48 L40.....	430	MHP 24 L25.....	413	MHV 32 G32.....	426
MGV 06.25 B.....	635	MHO 48 L50.....	430	MHP 24 L225.....	413	MHV 32 G40.....	426
MGV 06.32.....	633	MHO 50.25.....	432	MHP 24 LS25.....	413	MHV 32 G50.....	426
MGV 06.32 B.....	635	MHO 50.32.....	432	MHP 24 LS225.....	413	MHV 32 L40.....	426
MGV 06.40.....	633	MHO 50 X25.....	433	MHP 32.40.....	425	MHV 32 LG40.....	426
MGV 06.40 B.....	635	MHO 50 X32.....	433	MHP 32.50.....	425	MHV 32 X40.....	427
MGV 10.25.....	637	MHOE 06 L20M.....	531	MHP 32.240.....	425	MHV 48 L32.....	430
MGV 10.25 B.....	639	MHOE 06 L25M.....	531	MHP 32.250.....	425	MHV 48 L40.....	430
MGV 10.32.....	637	MHOE 10.20M.....	533	MHP 32 L40.....	425	MHV 48 L50.....	430
MGV 10.32 B.....	639	MHOE 10.25M.....	533	MHP 32 L50.....	425	MHVE 06 L20M.....	531
MGV 10.40.....	637	MHOE 16.25.....	544	MHP 32 L240.....	425	MHVE 06 L25M.....	531
MGV 10.40 B.....	639	MHOE 16.25M.....	535	MHP 32 LS40.....	425	MHVE 10.20M.....	533
MGV 16.25.....	641	MHOE 16.32.....	544	MHP 32 LS50.....	425	MHVE 10.25M.....	533
MGV 16.25 B.....	643	MHOE 16.32M.....	535	MHP 32 LS240.....	425	MHVE 16.2.....	544
MGV 16.32.....	641	MHOE 24.25.....	545	MHP 32 LS250.....	425	MHVE 16.25M.....	535
MGV 16.32 B.....	643	MHOE 24.25M.....	537	MHP 48 LS40.....	430	MHVE 16.32.....	544
MGV 16.40.....	641	MHOE 24.32.....	545	MHP 48 LS50.....	430	MHVE 16.32M.....	535
MGV 16.40 B.....	643	MHOE 24.32M.....	537	MHP 50.32.....	431	MHVE 24.25.....	545
MGV 16.50.....	641	MHOE 32.40.....	546	MHP 50.40.....	431	MHVE 24.25M.....	537
MGV 16.50 B.....	643	MHOE 48 L40.....	547	MHP 50.232.....	431	MHVE 24.32.....	545
MGV 16.225.....	641	MHOE 50.25.....	548	MHP 50.240.....	431	MHVE 24.32M.....	537
MGV 16.225 B.....	643	MHOE 50.32.....	548	MHP 50 CS32.....	431	MHVE 24.40M.....	537
MGV 24.32 B.....	647	MHON 06 L25.....	618	MHP 50 CS40.....	431	MHVE 32.40.....	546
MGV 24.40 B.....	647	MHON 10.25.....	620	MHP 50 CS232.....	431	MHVE 32 G40.....	546
MGV 24.50 B.....	647	MHON 16.32.....	622	MHP 50 CS240.....	431	MHVE 48 L40.....	547
MGV 24.232 B.....	647	MHON 24.32.....	624	MHPE 32.50.....	546	MHVN 06 L25.....	618
MGV 24.240 B.....	647	MHOR 06 L20.....	586	MHPE 48 LS40.....	547	MHVN 06 LG25.....	619
MGV 24.325 B.....	647	MHOR 10.20.....	587	MHPE 50.32.....	548	MHVN 10.25.....	620
MGVE 06.25.....	551	MHOR 16.25.....	588	MHPE 50.240.....	548	MHVN 10 G25.....	621
MGVE 06.32.....	551	MHOR 24.25.....	589	MHPR 10.20.....	587	MHVN 16.32.....	622
MGVE 06.40.....	551	MHOR 48 L40.....	590	MHPR 48 LS40.....	590	MHVN 16 G32.....	623
MGVE 10.25.....	553	MHOS 16.25.....	580	MHPW 32.50.....	525	MHVN 24.32.....	624
MGVE 10.32.....	553	MHOS 16.32.....	580	MHPW 48 LS40.....	526	MHVN 24 G32.....	625
MGVE 10.40.....	553	MHOS 24.25.....	581	MHPW 50.32.....	527	MHVR 06 L20.....	586
MGVE 16.25.....	555	MHOS 24.32.....	581	MHPW 50.240.....	527	MHVR 10.20.....	587
MGVE 16.32.....	555	MHOW 16.25.....	523	MHPX 32 L40.....	429	MHVR 16.25.....	588
MGVE 16.40.....	555	MHOW 16.32.....	523	MHPX 32 LP40.....	429	MHVR 24.25.....	589
MGVE 16.50.....	555	MHOW 24.25.....	524	MHPX 32 LP50.....	429	MHVR 48 L40.....	590
MGVE 16.225.....	555	MHOW 24.32.....	524	MHPX 32 LS40.....	429	MHVS 16.25.....	580
MGVE 24.32.....	557	MHOW 32.40.....	525	MHV 06 L20.....	389	MHVS 16.32.....	580
MGVE 24.40.....	557	MHOW 48 L40.....	526	MHV 06 L25.....	389	MHVS 24.25.....	581
MGVE 24.50.....	557	MHOW 50.25.....	527	MHV 06 LG25.....	390	MHVS 24.32.....	581
MGVE 24.232.....	557	MHOW 50.32.....	527	MHV 06 LX20.....	391	MHVW 16.25.....	523
MGVE 24.240.....	557	MHP 06 L20.....	388	MHV 06 LX25.....	391	MHVW 16.32.....	523
MGVE 24.325.....	557	MHP 06 L220.....	388	MHV 10.20.....	395	MHVW 24.25.....	524
MHO 06 L20.....	389	MHP 06 LS20.....	388	MHV 10.25.....	395	MHVW 24.32.....	524
MHO 06 L25.....	389	MHP 06 LS220.....	388	MHV 10 G25.....	398	MHVW 24 G32.....	524
MHO 06 LX20.....	391	MHP 10.20.....	394	MHV 10 L20.....	396	MHVW 32.40.....	525
MHO 06 LX25.....	391	MHP 10.220.....	394	MHV 10 L25.....	396	MHVW 32 G40.....	525
MHO 10.20.....	395	MHP 10 CP20.....	394	MHV 10 LG25.....	399	MHVW 48 L40.....	526
MHO 10.25.....	395	MHP 10 CP220.....	394	MHV 10 X20.....	400	MIO 16.40.....	407
MHO 10 L20.....	396	MHP 10 CS20.....	394	MHV 10 X25.....	400	MIO 16.50.....	407
MHO 10 L25.....	396	MHP 10 CS220.....	394	MHV 16.25.....	404	MIO 24.40.....	417
MHO 10 X20.....	400	MHP 10 L20.....	394	MHV 16.32.....	404	MIO 24.50.....	417
MHO 10 X25.....	400	MHP 10 L220.....	394	MHV 16 G32.....	408	MIO 24 YX40.....	613
MHO 16.25.....	404	MHP 10 LS20.....	394	MHV 16 L25.....	405	MIO 24 YX50.....	613
MHO 16.32.....	404	MHP 10 LS220.....	394	MHV 16 L32.....	405	MIV 16.40.....	407

\* These items are also shown in various sections throughout the catalogue

MIV 24.40 .....	417	MKAXXS VG25 .....	572	MVAP 24 LS32 .....	462	MZ7P 15 L25 .....	384
MIV 24.50 .....	417	MKAXX VG25 .....	361	MVAP 24 LS40 .....	462	MZ7P 15 L225 .....	384
MIV 24 YX40 .....	613	MKAXXW AP25 .....	515	MVAP 24LS232 .....	462	MZ7P 15 LS25 .....	384
MIV 24 YX50 .....	613	MKAXXW IAP25 .....	515	MVAP 24LS240 .....	462	MZ7P 15LS225 .....	384
MKA AP20 .....	349	MKAXXW VG25 .....	518	MVAP 24LSP25 .....	460	MZ7P 25 L25 .....	385
MKA AP25 .....	359	MKG V25 .....	348	MVAP 24LSP32 .....	460	MZ7P 25 L225 .....	385
MKAE V20 .....	538	MKG VAN20 .....	347	MVAP 24LSP40 .....	460	MZ7P 25 LS25 .....	385
MKAE VA20 .....	538	MKG VN20 .....	347	MVAV 06 LG25 .....	447	MZ7P 25LS225 .....	385
MKAG V20 .....	355	MKG VN25 .....	348	MVAV 06 LG32 .....	447	MZ7PE 15L225 .....	540
MKAG VA20 .....	355	MK IAP20 .....	339	MVAV 10 G25 .....	453	MZ7PE 25L225 .....	541
MKA IAF20 .....	350	MK IAPN20 .....	339	MVAV 10 G32 .....	453	MZ7PS 15L225 .....	576
MKA IAF25 .....	350	MK V20 .....	340	MVAV 10 LG25 .....	453	MZ7PS 25L225 .....	577
MKA IAP20 .....	349	MK V25 .....	341	MVAV 10 LG32 .....	453	MZ7PW 15L225 .....	519
MKA IAP25 .....	359	MK VA20 .....	340	MVAV 16 G25 .....	458	MZ7PW 25L225 .....	520
MKA IF .....	363	MK VAN20 .....	340	MVAV 16 G32 .....	458	MZAO 15 L20 .....	376
MKAR V20 .....	583	MK VG20 .....	340	MVAV 16 LG25 .....	458	MZAO 15 L25 .....	376
MKAR VA20 .....	583	MK VG25 .....	342, 352, 353	MVAV 16 LG32 .....	458	MZAO 25 L20 .....	380
MKAS AP25 .....	567	MK VGN20 .....	340	MVAV 24 G25 .....	463	MZAO 25 L25 .....	380
MKAS IAP25 .....	567	MK VGN25 .....	343	MVAV 24 G32 .....	463	MZAOE 15 L25 .....	540
MKAS IF .....	569	MK VN20 .....	340	MVAV 24 LG25 .....	463	MZAOE 25 L25 .....	541
MKAS IVG20 .....	571	MK VN25 .....	341	MVAV 24 LG32 .....	463	MZAOW 15 L25 .....	519
MKAS V20 .....	564	MQ 08 VO225 .....	366	MVFV 06 LG25 .....	447	MZAOW 25 L25 .....	520
MKAS V25 .....	564	MQO 24.40 .....	418	MVFV 06 LG32 .....	447	MZAP 25 L25 .....	378
MKAS VA20 .....	564	MQV 24.40 .....	418	MVFV 10 G25 .....	453	MZAP 25 L225 .....	378
MKAS VG25 .....	572	MVAP 06 LP32 .....	446	MVFV 10 G32 .....	453	MZAP 25 LS25 .....	378
MKA V20 .....	351	MVAP 06 LP40 .....	446	MVFV 10 LG25 .....	453	MZAP 25LS225 .....	378
MKA VA20 .....	351	MVAP 06LP232 .....	446	MVFV 10 LG32 .....	453	MZAP 25LSP20 .....	379
MKA VG20 .....	351	MVAP 06LP240 .....	446	MVFV 16 G25 .....	458	MZAP 25LSP25 .....	379
MKA VG25 .....	361	MVAP 06 LS32 .....	446	MVFV 16 G32 .....	458	MZAPR 06 L32 .....	586
MKAW V20 .....	512	MVAP 06 LS40 .....	446	MVFV 16 LG25 .....	458	MZAV 15 L20 .....	376
MKAW V25 .....	512	MVAP 06LS232 .....	446	MVFV 16 LG32 .....	458	MZAV 15 L25 .....	376
MKAW VA20 .....	512	MVAP 06LS240 .....	446	MVFV 24 G25 .....	463	MZAV 25 L20 .....	380
MKAX AP20 .....	349	MVAP 06LSP25 .....	445	MVFV 24 G32 .....	463	MZAV 25 L25 .....	380
MKAX AP25 .....	358	MVAP 06LSP32 .....	445	MVFV 24 LG25 .....	463	MZAV 25 L220 .....	380
MKAXE AP20 .....	538	MVAP 06LSP40 .....	445	MVFV 24 LG32 .....	463	MZAVE 15 L25 .....	540
MKAXE IAF20 .....	539	MVAP 10 L32 .....	451	MVI 10 LAP32 .....	450	MZAVE 25 L25 .....	541
MKAXE IAF25 .....	539	MVAP 10 L40 .....	451	MVP 06 LP20 .....	446	MZAVW 15 L25 .....	519
MKAXE IAF20 .....	538	MVAP 10 L232 .....	451	MVP 06 LP220 .....	446	MZAVW 25 L25 .....	520
MKAXE VG20 .....	538	MVAP 10 L240 .....	451	MVP 06 LS20 .....	446	MZFO 15 L20 .....	376
MKAX IAF20 .....	350	MVAP 10 LP32 .....	452	MVP 06 LS220 .....	446	MZFO 15 L25 .....	376
MKAX IAF25 .....	350	MVAP 10 LP40 .....	452	MVP 06 LSP20 .....	445	MZFO 25 L20 .....	380
MKAX IAP20 .....	349	MVAP 10LP232 .....	452	MVP 10 L20 .....	451	MZFO 25 L25 .....	380
MKAX IAP25 .....	358	MVAP 10LP240 .....	452	MVP 10 L220 .....	451	MZFOS 15 L25 .....	576
MKAX IF .....	362	MVAP 10 LS32 .....	452	MVP 10 LP20 .....	452	MZFOS 25 L25 .....	577
MKAXR AP20 .....	583	MVAP 10 LS40 .....	452	MVP 10 LP220 .....	452	MZFBV 15 L20 .....	376
MKAXR IAP20 .....	583	MVAP 10LS232 .....	452	MVP 10 LS20 .....	452	MZFBV 15 L25 .....	376
MKAXR IF .....	584	MVAP 10LS240 .....	452	MVP 10 LS220 .....	452	MZFBV 25 L20 .....	380
MKAXR VG20 .....	583	MVAP 10LSP25 .....	449	MVP 10 LSP20 .....	449	MZFBV 25 L25 .....	380
MKAXS AP20 .....	564	MVAP 10LSP32 .....	449	MVP 10 LSP25 .....	449	MZFBV 25 L220 .....	380
MKAXS AP25 .....	566	MVAP 10LSP40 .....	449	MVP 16 L25 .....	456	MZFBVS 15 L25 .....	576
MKAXS IAP20 .....	564	MVAP 16 L32 .....	456	MVP 16 L225 .....	456	MZFBVS 25 L25 .....	577
MKAXS IAP25 .....	566	MVAP 16 L40 .....	456	MVP 16 LP25 .....	457	MZO 15 L20 .....	376
MKAXS IF .....	568	MVAP 16 L232 .....	456	MVP 16 LP225 .....	457	MZO 15 L25 .....	376
MKAXS IVG20 .....	570	MVAP 16 L240 .....	456	MVP 16 LS25 .....	457	MZO 25 L20 .....	380
MKAXS VG20 .....	564	MVAP 16 LP32 .....	457	MVP 16 LS225 .....	457	MZO 25 L25 .....	380
MKAXS VG25 .....	572	MVAP 16 LP40 .....	457	MVP 16 LSP25 .....	455	MZOE 15 L20 .....	540
MKAX VG20 .....	351	MVAP 16LP232 .....	457	MVP 24 L25 .....	461	MZOE 15 L25 .....	540
MKAX VG25 .....	360	MVAP 16LP240 .....	457	MVP 24 L225 .....	461	MZOE 25 L20 .....	541
MKAXW AP20 .....	512	MVAP 16 LS32 .....	457	MVP 24 LP25 .....	462	MZOE 25 L25 .....	541
MKAXW AP25 .....	514	MVAP 16 LS40 .....	457	MVP 24 LP225 .....	462	MZOS 15 L20 .....	576
MKAXW IAP20 .....	512	MVAP 16LS232 .....	457	MVP 24 LS25 .....	462	MZOS 15 L25 .....	576
MKAXW IAP25 .....	514	MVAP 16LS240 .....	457	MVP 24 LS225 .....	462	MZOS 25 L20 .....	577
MKAXW IF .....	516, 517	MVAP 16LSP25 .....	455	MVP 24 LSP25 .....	460	MZOS 25 L25 .....	577
MKAXW VG20 .....	512	MVAP 16LSP32 .....	455	MVV 06 LG25 .....	447	MZOW 15 L20 .....	519
MKAXW VG25 .....	518	MVAP 16LSP40 .....	455	MVV 10 G25 .....	453	MZOW 15 L25 .....	519
MKAXX AP25 .....	359	MVAP 24 L32 .....	461	MVV 10 LG25 .....	453	MZOW 25 L20 .....	520
MKAXX IAP25 .....	359	MVAP 24 L40 .....	461	MVV 16 G32 .....	458	MZOW 25 L25 .....	520
MKAXX IF .....	363	MVAP 24 L232 .....	461	MVV 16 LG32 .....	458	MZP 15 L25 .....	374
MKAXXR IF .....	585	MVAP 24 L240 .....	461	MVV 24 G32 .....	463	MZP 15 L225 .....	374
MKAXXS AP25 .....	567	MVAP 24 LP32 .....	462	MVV 24 LG32 .....	463	MZP 15 LS25 .....	374
MKAXXS IAP25 .....	567	MVAP 24 LP40 .....	462	MXA 01 O25 .....	369	MZP 15 LS225 .....	374
MKAXXS IF .....	569	MVAP 24LP232 .....	462	MXA 01 V25 .....	369	MZP 15 LSP20 .....	375
MKAXXS IVG20 .....	571	MVAP 24LP240 .....	462	MXA 01 V32 .....	369	MZP 15 LSP25 .....	375

\* These items are also shown in various sections throughout the catalogue



MZPR 06 L20	586
MZV 15 L20	376
MZV 15 LG20	376
MZV 25 L20	380
MZV 25 LG20	381
MZVE 15 L20	540
MZVE 25 L20	541
MZVS 15 L20	576
MZVS 25 L20	577
MZVW 15 L20	519
MZVW 25 L20	520

## R

RAC 06 L	600
RAC 10 L	600
RAC 16 L	600
RAC 24 L	600
RCEF 06	214
RCEF 10	215
RCEF 16	216
RCEF 24	217
RCEM 06	214
RCEM 10	215
RCEM 24	217
RCF2D 0.3	214*
RCF2D 0.5	214*
RCF2D 0.7	214*
RCF2D 1.0	214*
RCF2D 1.5	214*
RCF2D 2.5	214*
RCF2D 3.0	214*
RCF2D 4.0	214*
RCM2D 0.3	214*
RCM2D 0.5	214*
RCM2D 0.7	214*
RCM2D 1.0	214*
RCM2D 1.5	214*
RCM2D 2.5	214*
RCM2D 3.0	214*
RCM2D 4.0	214*
RDDF 24	210
RDDF 42	211
RDDF 72	212
RDDF 108	213
RDDM 24	210
RDDM 42	211
RDDM 72	212
RDDM 108	213
RDF2D 0.3	208*
RDF2D 0.5	208*
RDF2D 0.7	208*
RDF2D 1.0	208*
RDF2D 1.5	208*
RDF2D 2.5	208*
RDF 40	208
RDF 64	209
RDM2D 0.3	208*
RDM2D 0.5	208*
RDM2D 0.7	208*
RDM2D 1.0	208*
RDM2D 1.5	208*
RDM2D 2.5	208*
RDM 40	208

RDM 64	209
RFO 06 L32	593
RFO 10 L32	595
RFO 16 L32	597
RFO 24 L40	599
RFV 06 L32	593
RFV 10 L32	595
RFV 16 L32	597
RFV 24 L40	599
RHO 06 L25	593
RHO 10 L25	595
RHO 16 L32	597
RHO 24 L32	599
RHV 06 L25	593
RHV 10 L25	595
RHV 16 L32	597
RHV 24 L32	599
RQEEF 40	218
RQEEF 64	219
RQEEM 40	218
RQEEM 64	219
RVAP 06 L32	592
RVAP 06 L232	592
RVAP 10 L32	594
RVAP 10 L232	594
RVAP 16 L32	596
RVAP 16 L232	596
RVAP 24 L32	598
RVAP 24 L232	598
RVI 06 L	592
RVI 10 L	594
RVI 16 L	596
RVI 24 L	598
RVP 06 L20	592
RVP 06 L220	592
RVP 10 L20	594
RVP 10 L220	594
RVP 16 L25	596
RVP 16 L225	596
RVP 24 L25	598
RVP 24 L225	598
RX 02 TF	303
RX 02 TM	303
RX 03 TF	303
RX 03 TM	303
RX 04 TF	303
RX 04 TM	303
RX 06 TF	303
RX 06 TM	303
RXF2D 1.5	221*
RXF2D 2.5	221*
RXF2D 4.0	221*
RXF2D 6.0	221*
RXF2D 10	291, 293
RXF 12/2	221
RXM2D 1.5	221*
RXM2D 2.5	221*
RXM2D 4.0	221*
RXM2D 6.0	221*
RXM2D 10	291, 293
RXM 12/2	221

## S

SDS	701
-----	-----

## T

TAPC 06 L25	506
TAPC 06 L32	506
TAPC 10.25	507
TAPC 10.32	507
TAPC 16.32	508
TAPC 16.40	508
TAPC 24.32	509
TAPC 24.40	509
TAPH 06 L25	501
TAPH 06 L32	501
TAPH 10.25	502
TAPH 10.32	502
TAPH 16.32	503
TAPH 16.40	503
TAPH 24.40	504
TAPH 24.322	504
TAPW 06 L25	489
TAPW 06 L32	489
TAPW 10.25	490
TAPW 10.32	490
TAPW 16.32	491
TAPW 16.40	491
TAPW 24.32	492
TAPW 24.40	492
TAVC 06 LG25	506
TAVC 06 LG32	506
TAVC 10 G25	507
TAVC 10 G32	507
TAVC 16 G32	508
TAVC 16 G40	508
TAVC 24 G32	509
TAVC 24 G40	509
TAVH 06 LG25	501
TAVH 06 LG32	501
TAVH 10 G25	502
TAVH 10 G32	502
TAVH 16 G32	503
TAVH 16 G40	503
TAVH 24 G32	504
TAVH 24 G40	504
TAVW 06 LG25	489
TAVW 06 LG32	489
TAVW 10 G25	490
TAVW 10 G32	490
TAVW 16 G32	491
TAVW 16 G40	491
TAVW 24 G32	492
TAVW 24 G40	492
TCHC 06 L	481
TCHC 06 LG	481
TCHC 06 SL	481
TCHC 10	483
TCHC 10 G	483
TCHC 10 S	483
TCHC 16	485
TCHC 16 G	485
TCHC 16 S	485
TCHC 24	487
TCHC 24 G	487
TCHC 24 S	487

TCHI 06 L	480
TCHI 10	482
TCHI 16	484
TCHI 24	486
THCC 06 LG	506
THCC 10 G	507
THCC 16 G	508
THCC 24 G	509
THCH 06 LG	501
THCH 10 G	502
THCH 16 G	503
THCH 24 G	504
THCW 06 LG	489
THCW 10 G	490
THCW 16 G	491
THCW 24 G	492
THIC 06 L	506
THIC 10	507
THIC 16	508
THIC 24	509
THIH 06 L	501
THIH 10	502
THIH 16	503
THIH 24	504
THIW 06 L	489
THIW 10	490
THIW 16	491
THIW 24	492
TMAO 06 L25	480
TMAO 10.25	482
TMAO 10.32	482
TMAO 16.32	484
TMAO 16.40	484
TMAO 24.32	486
TMAO 24.40	486
TMAP 06 L25	480
TMAP 06 L32	480
TMAP 10.25	482
TMAP 10.32	482
TMAP 16.32	484
TMAP 16.40	484
TMAP 24.32	486
TMAP 24.40	486
TMAV 06 LG25	481
TMAV 06 LG32	481
TMAV 10.25	482
TMAV 10.32	482
TMAV 10 G25	483
TMAV 10 G32	483
TMAV 16.32	484
TMAV 16.40	484
TMAV 16 G32	485
TMAV 16 G40	485
TMAV 24.32	486
TMAV 24.40	486
TMAV 24 G32	487
TMAV 24 G40	487
TM BLC125	665

## Z

ZFU-CD	728
--------	-----

## Dimensioning of clearances and creepage distances

European standard **EN 61984:2009** which incorporates without modification the corresponding international standard **IEC 61984 Ed. 2.0 (2008-10)** is the reference standard for safety requirements and the relevant tests for multipole connectors for industrial uses.

It is applicable to connectors with rated voltage values of over 50 V, and up to 1 000 V, and rated currents values of up to 125 A per pole, for which no dedicated standard exists, or to which the detail specifications or the manufacturer refer as regards the safety aspects. It can be used as a guide for connectors with rated voltage exceeding 125 A per pole and for those with a rated voltage up to 50 V (the latter excluded from the scope of the Low Voltage Directive 2014/35/EU).

The last edition of the EN 61984 standard also introduced the definition of **connector without breaking capacity (COC)** to better distinguish this category of products from **connectors with breaking capacity (CBC)**.

For the safety and performance requirements of connector terminals, which depend on the connection technology adopted, this standard integrally refers to the corresponding standards (EN IEC 60999 series for screw-type and screwless type terminals, EN IEC 60352 series for solderless connections and relevant terminations).

For determining the minimum clearances and creepage distances (i.e. distances through-air and along the insulating surface) for connectors, this standard now refers, without any modifications to standard **IEC 60664-1 Ed. 2.0 (2007-04)<sup>1</sup>**.

In the following, the method for determining the minimum insulation in connectors is illustrated with reference to the IEC 60664-1 standard. The rated characteristics of each ILME connector family are provided on pages 14-19. As already in the first edition, the following are now obsolete: the insulation group concept and the distinction of rated voltage values into DC and AC, voltage values 220 V and 380 V were adapted to standardised values 230 V and 400 V according to IEC 60038<sup>2</sup> and some concepts were taken from the regulations for LV electrical systems of the IEC 60364<sup>3</sup> series, such as:

- the **overvoltage category** (I, II, III, IV), according to the use of the equipment<sup>4</sup>: this is correlated with the transient overvoltages taken as a basis for determining the rated impulse voltage;
- the **pollution degree** (1, 2, 3);
- the **material group** (I, II, III) (classification of insulating materials according to their resistance to tracking);
- the **electric field condition** (*homogenous or inhomogeneous*).

### a. Overvoltage categories (or impulse withstand category)

The overvoltage category of a circuit or of an electrical system are identified by a conventional numeral (from I to IV) based on the limitation or the control of the assumed transient overvoltage values obtained on a circuit or electrical system and depends on the means used to reduce the overvoltages.

**Table F.1** provides the rated impulse voltage for equipment energised directly from the low voltage mains as a function of the rated voltage of the power supply system, of the relevant line-to-neutral voltage and of the overvoltage category.

1) Endorsed with modifications as European standard EN 60664-1:2007 and published by CENELEC member countries as a national standard: Italian standard CEI EN 60664-1:2008-04 (CEI 109-1), German standard DIN EN 60664-1:2008-01 (VDE 0110-1)

2) EN 60038:2011 (IEC 60038-2009, modified), Italian standard CEI EN 60038:2012-08 (CEI 8-6), German standard DIN EN 60038:2012-04 (VDE 0175-1)

3) Italian standard CEI 64-8, German standard DIN VDE 0100

4) EN 60664-1 clarifies that the term "overvoltage category" is synonymous with "impulse withstand category" used in Clause 443 of IEC 60364-4-44

**TABLE F.1.**

**Rated impulse voltage for equipment powered directly from the low-voltage mains (IEC 60664-1 Ed. 2.0 2008-10)**

Nominal voltage according to IEC 60038 (CENELEC HD 472 S1, CEI 8-6)		Voltage line to neutral derived from nominal voltages a.c. or d.c.	Rated impulse voltage <sup>b)</sup>			
			Overvoltage category			
V	V	≤	V			
Three-phase <sup>a)</sup>	Single phase		I	II	III	IV
		50	330	500	800	1500
		100	500	800	1500	2500
	120-240	150	800	1500	2500	4000
230/400 277/480		300	1500	2500	4000	6000
400/690		600	2500	4000	6000	8000
1000		1000	4000	6000	8000	12000

a) The "T" symbol indicates a four-wire three phase distribution system (star distribution). The lower value is the voltage between phase and neutral (phase voltage), whereas the higher value is the voltage between the phases (mains voltage). Where only one value is indicated, it refers to three-wire, three-phase systems (delta distribution) and specifies the line-to-line value.

b) Equipment with these rated impulse values can be used in installations in accordance with standard IEC 60364-4-443 (Italian standard CEI 64-8/4 Section 443, German DIN VDE 0100-443).

**Industrial machinery and installations with fixed connection to the low voltage supply system, hence their relevant components including multipole connectors, constitute an example of equipment belonging to overvoltage category III.**

Examples of general equipment that comes under overvoltage category II are household electrical appliances, portable tools and other household or similar equipment.

For distribution networks with rated voltage **230/400 V** (star distribution, neutral-earthed) and overvoltage category III (impulse withstand category III), the required rated impulse withstand voltage is **4 kV**.

For distribution networks with rated voltage **400 V** or **500 V** (star distribution without neutral or with unearthed neutral, or delta distribution unearthed or corner-earthed) and overvoltage category III (impulse withstand category III), the required rated impulse withstand voltage is **6 kV**.

### b. Pollution degree

Pollution indicates the presence of any kind of foreign matter, whether solid, liquid or gaseous (ionised gas) that can result in a reduction of dielectric strength or surface resistivity of the insulation. The standard establishes four pollution degrees. The categories are identified by conventional numerals based on the quantity of polluting agents or on the frequency of the phenomenon which determines the reduction of the dielectric strength and/or of the surface resistivity.

#### Pollution degree 1

No pollution or only dry, non-conductive pollution. The pollution has no influence.

#### Pollution degree 2

Only non-conductive pollution occurs except that occasionally a temporary conductivity caused by condensation is to be expected.



### Pollution degree 3

Conductive pollution occurs or dry non-conductive pollution occurs which becomes conductive due to condensation which is to be expected.

### Pollution degree 4

Continuous conductivity occurs due to conductive dust, rain or other wet conditions.

**Pollution degree 3 is typical of an industrial environment or similar, while pollution degree 2 is typical of a household or similar environment.**

EN 61984 allows the dimensioning of creepage distances (insulating distances along the surfaces) of connectors installed in enclosures with degree of protection  $\geq$ IP54 for the pollution degree immediately below that of the application environment (e.g.: 2 instead of 3).

#### Abstract from EN 61984

**6.19.2.1** For a connector with a degree of protection IP54 or higher according to IEC 60529, the insulating parts inside the enclosure may be dimensioned for a lower pollution degree.

This lower pollution degree also applies to mated connectors where the enclosure is ensured by the connector housing and which may only be disengaged for test and maintenance purposes.

One may therefore use connectors installed in housings or enclosures with a degree of protection  $\geq$  IP54, at the rated voltage suitable to pollution degree 2 in industrial applications with pollution degree 3, if, in compliance with EN 61984, the connector coupling is opened only occasionally for test and maintenance purposes. Even in the event of temporary or limited permanence in uncoupled state, a closing cover is recommended in order to guarantee at least the IP54 degree of protection.

However, this does not apply to connectors which remain uncoupled and exposed to an industrial atmosphere for an indefinite period.

It should also be noted that pollution might penetrate inside coupled connectors also from remote parts of the electrical system, e.g. through conduits providing cable entry to the connectors enclosure.

Moreover, connector enclosures are usually supplied without cable entry devices, to let the installer select the most suitable one for its end-use application. The IP degree of protection – or the Type rating according to North American standards – marked or assigned to the connector enclosures is guaranteed only for mated and locked connectors that employ cable entry devices with IP degree and/or Type rating equal or higher than those of the connector enclosures chosen, installed in a workmanlike manner.

#### Examples of application for the selection of pollution degree 2 for a connector.

- Connector on an electric motor controller, which is uncoupled only to replace a faulty motor, also in cases where pollution degree 3 is instead specified for the system.
- Connector on a machine built in modules, which is opened only for transport purposes and which is used only for faster installation and for safer putting into service. One must make sure that the connector has not been polluted during transport. To ensure this has not occurred, protective covers or adequate packing must be used.
- Connector inside a panel with degree of protection  $\geq$  IP54. In this case one may even avoid equipping the connector with an IP54 enclosure.

### c. Material group

The insulating material influences the determination of the minimum creepage distance. It is characterised according to the damage it suffers from the concentrated release of energy during scintillations when a surface leakage current is interrupted due to the drying of the contaminated surface.

The CTI (comparative tracking index, index of resistance to surface currents, defined in EN IEC 60112) is assumed as index of the resistance to creep currents of the insulating materials in the presence of atmospheric contaminating agents.

The CTI constitutes the numerical value of the maximum voltage at which a material can resist against 50 drops of an electrolytic test solution without tracking failure, i.e. without failure of insulation due to a progressive formation of conductive paths on the surface and/or within the solid insulating material (causing permanent electric arc between the electrodes of the test equipment) due to the combined effect of electric stress and electrolytic contamination.

Solid insulating materials are classified into four groups:

<b>group I</b>	<b>600 <math>\leq</math> CTI</b>
<b>group II</b>	<b>400 <math>\leq</math> CTI &lt; 600</b>
<b>group IIIa</b>	<b>175 <math>\leq</math> CTI &lt; 400</b>
<b>group IIIb</b>	<b>100 <math>\leq</math> CTI &lt; 175</b>

For the purpose of determining the minimum creepage distances, the values for groups IIIa / IIIb (Table F.2, IEC 60664-1) are identical.

**The insulating materials used to manufacture the ILME multipole connectors belong to groups IIIa / IIIb.**

### d. Electric field conditions

Minimum clearance (shortest distance in air between two conductive parts) is determined by Table F.2 of IEC 60664-1, bearing in mind the following influencing factors:

- the rated impulse voltage;
- the electric field condition;
- the altitude: the values specified in Table 2 are valid up to 2 000 m; for higher altitudes, the corrective factors specified in Table F.8 of IEC 60664-1 shall be used;
- the micro-environment.

The shape and arrangement of the conductive parts influence homogeneity of the electric field, hence the clearance able to insulate live parts. Clearances of **case A (inhomogeneous field)** withstand the corresponding impulse voltage under all conditions: clearances not less than those specified in **Table F.2 – case A** can be used irrespective of the shape and arrangement of the conductive parts and without verification by an impulse test.

**1. Determination of clearances**

To determine minimum clearance, the following must be identified in accordance with IEC 60664-1 standard:

- a) the rated voltage of the power supply (usually 230/400 V thus a conventional voltage line-to-neutral of 300 V, in star distribution networks with earthed neutral, or 400 V for star networks without neutral, or with unearthed neutral, or in networks with secondary windings of the distribution transformer delta connected, unearthed or corner-earthed and, therefore, with conventional line voltage 600 V);
- b) the overvoltage category (usually III).
- c) The rated impulse voltage determined from Table B.2 of IEC 60664-1 (usually 4 kV or 6 kV).
- d) The electric field condition to which the parts through which the current flows shall be subjected (worst case = inhomogeneous field) and the pollution degree (usually 3).

EN 61984 requires that the **clearance** be dimensioned according to IEC 60664-1. For clearances up to 2 mm, typically for printed circuit board connectors, the reference standard may alternatively be IEC 60664-5, to be read in conjunction with IEC 60664-1. The minimum clearance (shortest distance in air between two conductive parts) is therefore given by Table F.2 of IEC 60664-1, according to the rated impulse voltage derived from Table B.2 of the same standard, which is part of Annex B (informative) **Nominal voltages of supply systems for different modes of overvoltage control**. This table is attributable in particular to devices that do not foresee upstream any overvoltage surge arrester; it represents, therefore the “worst case” and replaces Table 5 of the previous edition of EN 61984. The rated impulse voltage must be chosen based on the nominal supply voltage and the overvoltage category. The assignment of connectors to a particular overvoltage category (usually III) is performed according to the rules of IEC 60664-1.

Here below three important definitions from EN 61984 to consider regarding “voltage”:

**rated voltage**  
value of voltage assigned by the manufacturer to the connector and to which the operating and performance characteristics are referred

NOTE – A connector may have more than one rated voltage value.

[IEC 60664-1:2007, definition 3.9, modified].

**rated impulse voltage**  
impulse withstand voltage assigned by the manufacturer to the connector, characterizing the specified withstand capability of its insulation against transient overvoltages

[IEC 60664-1:2007, 3.9.2, modified].





**impulse withstand voltage**  
highest peak value of impulse voltage of prescribed form and polarity which does not cause insulation breakdown of insulation under specified conditions

NOTE – The impulse withstand voltage is equal to or higher than the rated impulse voltage

[IEC 60664-1:2007, 3.8.1, modified].

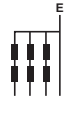
In regard to the choice of the electric field condition, the clearances through possible windows and openings in the insulating material housings, shall comply with the values of Case A of Table F.2 of IEC 60664-1, i.e. for inhomogeneous field conditions.

**TABLE B.2**  
Inherent control or control of equivalent protection [IEC 60664-1 Ed.2.0 (2007-04)].

Voltage line-to-neutral derived from nominal voltages a.c. or d.c. up to and including <sup>1</sup>	Nominal voltages presently used in the world				Rated impulse voltage for the device <sup>1</sup>			
	Three-phase four wire systems with earthed neutral	Three-phase three-wire systems earthed or unearthed	Single-phase two-wire systems a.c. or d.c.	Single-phase three-wire systems a.c. or d.c.				
					Overvoltage category			
V	V	V	V	V	I	II	III	IV
50			12,5 24 25 30 42 48	30-60	330	500	800	1500
100	66/115	60	60		500	800	1500	2500
150	120/208 *) 127/220	115, 120, 127	100 **), 110, 120	100/- 200 *) 110-220 120-240	800	1500	2500	4000
300	220/380, 230/400, 240/415, 260/440, 277/480	200 **), 220, 230, 240, 260, 277	220	220-440	1500	2500	4000	6000
600	347/600 380/660 400/690 417/720 480/830	347, 380, 400, 415, 440, 480, 500, 577, 600	480	480-960	2500	4000	6000	8000
1000		660 690, 720 830/1000	1000		4000	6000	8000	12000

1) These columns are taken from Table F.1 indicating the te rated impulse withstand voltages.  
\*) Used in the United States and Canada.  
\*\*) Used in Japan

With the three values (b) (c) and (d) the minimum clearance is determined in Table F.2 IEC 60664-1

**TABLE F.2**

Clearances to withstand transient overvoltages [IEC 60664-1 Ed. 2.0 (2007-04)].

Required impulse withstand voltage <sup>1) 5)</sup>	Minimum clearances in air up to 2.000 m. above sea level					
	Case A Inhomogeneous field (see 3.15) Pollution degree <sup>6)</sup>			Case B Homogeneous field (see 3.14) Pollution degree <sup>6)</sup>		
	1	2	3	1	2	3
kV	mm	mm	mm	mm	mm	mm
0,33 <sup>2)</sup>	0,01	0,2 <sup>3) 4)</sup>	0,8 <sup>4)</sup>	0,01	0,2 <sup>3) 4)</sup>	0,8 <sup>4)</sup>
0,4	0,02			0,02		
0,50 <sup>2)</sup>	0,04			0,04		
0,6	0,06			0,06		
0,80 <sup>2)</sup>	0,1			0,1		
1	0,15			0,15		
1,2	0,25	0,25	0,2	0,3	0,3	
1,5 <sup>2)</sup>	0,5	0,5	0,45	0,45		
2	1	1	1	0,6	0,6	
2,5 <sup>2)</sup>	1,5	1,5	1,5	0,8	0,8	
3	2	2	2	1,2	1,2	1,2
4,0 <sup>2)</sup>	3	3	3	1,5	1,5	1,5
5	4	4	4	2	2	2
6,0 <sup>2)</sup>	5,5	5,5	5,5	3	3	3
8,0 <sup>2)</sup>	8	8	8	3,5	3,5	3,5
10	11	11	11	4,5	4,5	4,5
12 <sup>2)</sup>	14	14	14	5,5	5,5	5,5
15	18	18	18	8	8	8
20	25	25	25	10	10	10
25	33	33	33	12,5	12,5	12,5
30	40	40	40	17	17	17
40	60	60	60	22	22	22
50	75	75	75	27	27	27
60	90	90	90	35	35	35
80	130	130	130	45	45	45
100	170	170	170			

- 1) This voltage is
  - for functional insulation, the maximum impulse voltage expected to occur across the clearance (see 5.1.5),
  - for basic insulation directly exposed or significantly influenced by transient overvoltages from the low-voltage mains (see 4.3.3.3, 4.3.3.4.1 and 5.1.6), the rated impulse voltage of the equipment,
  - for other basic insulations (see 4.3.3.4.2), the highest impulse voltage that can occur in the circuit.
- For reinforced insulation see 5.1.6.
- 2) Preferred values as specified in 4.2.3.
- 3) For printed wiring material, the values for pollution degree 1 apply except that the value shall not be less than 0,04 mm, as specified in Table F.4.
- 4) The minimum clearances given for pollution degrees 2 and 3 are based on the reduced withstand characteristics of the associated creepage distance under humidity conditions (see IEC 60664-5).
- 5) For parts or circuits within equipment subjected to impulse voltages according to 4.3.3.4.2, interpolation of values is allowed. However, standardization is achieved by using the preferred series of impulse voltage values in 4.2.3.
- 6) The dimensions for pollution degree 4 are as specified for pollution degree 3, except that the minimum clearance is 1,6 mm.

When the clearance is less than the value indicated for case A, an impulse voltage test is required.

Compared to the previous edition of IEC 60664-1, Table F.2 has been modified. In particular: the columns referring to pollution degree 4 have been removed, the definition of this pollution degree has been modified in 4.6.2 to: "continuous conductivity occurs due to conductive dust, rain or other wet conditions", and clearances for pollution degree 4 area as specified for degree of pollution 3, with the exception that the minimum clearance is 1,6 mm.

In 4.6.3 it states: "The dimensions for creepage distance cannot be specified where permanently conductive pollution is present (pollution degree 4). For temporarily conductive pollution (pollution degree 3), the surface of the insulation may be designed to avoid a continuous path of conductive pollution, e.g. by means of ribs and grooves (see 5.2.2.5 and 5.2.5)".

**The values in bold are the most common in multipole connectors for industrial purposes.**

If the component fulfils the minimum clearance prescribed for live parts at opposed polarities, it is exempted from the impulse withstand test. This test is run at sea level using increased voltage values in order to take into account rarefied air at high altitude (the prescribed values refer to 2 000 m a.s.l.). However, if this minimum clearance is not fulfilled, passing the test gives one the right to declare the relevant rated impulse voltage. Declaration of the rated impulse voltage is optional according to EN 61984: if the manufacturer declares the rated impulse voltage, the impulse withstand test is necessary as dielectric verification.

Alternatively, a dielectric voltage withstand test at mains frequencies of 50/60 Hz for 60 s (test 4a of IEC 60512) is necessary, but at reduced values compared to the peak values of the impulse test voltages of wave shape standardised at 1,2/50 µs.

For this purpose, standard EN 61984 provides the following cross-reference table:

**TABLE 8**  
 Test voltages (EN 61984 Ed. 2.0 - 2009-06)

Rated impulse withstand voltage $U_{ipm}$ kV	Test voltages		
	Impulse withstand voltage* kV (1,2/50 µs)		Withstand voltage (r.m.s. value) kV (50/60 Hz)
	at 2000 above sea level	at sea level	
0,5	0,5	0,55	0,37
0,8	0,8	0,91	0,5
1,5	1,5	1,75	0,84
2,5	2,5	2,95	1,39
4	4	4,8	2,21
6	6	7,3	3,31
8	8	9,8	4,26
12	12	14,8	6,6

\* If the test laboratory is situated between sea level and an altitude of 2 000 m a.s.l., interpolation of impulse withstand voltage is allowed.

**NOTE:** This table uses the characteristics of an inhomogeneous field, case A of IEC 60664-1 (worst case).

## 2. Determination of minimum creepage distance

For the **minimum creepage distance** (*shortest distance along the surface of a solid insulating material between two conductive parts*, IEC 60664-1 definition 3.3) IEC 61984 refers to what prescribed by IEC 60664-1 in **Table F.4**. It is determined according to: rated voltage, pollution degree and insulating material group.

The rated voltage providing access to **Table F.4** (rationalised voltage derived from the nominal voltages at which the connector is deemed to operate) is determined by **Table F.3a** of IEC 60664-1 for single-phase two or three-wire AC or DC systems or **Table F.3b** for three-phase three or four-wire AC systems.

**TABLE F.3a**

Single-phase two or three-wire AC or DC systems  
(IEC 60664-1 Ed. 2.0 - 2007-04).

Rated supply voltage <sup>1)</sup>	Rationalised voltages for Table F.4	
	For insulation phase-phase <sup>1)</sup>	
	All systems	Three-wire systems with intermediate earth point
V	V	V
12,5	12,5	-
24	25	-
25	25	-
30	32	-
42	50	-
48	50	-
50 **)	50	-
60	63	-
30-60	63	32
100 **)	100	-
110	125	-
120	125	-
150 **)	160	-
220	250	-
110-220	250	125
120-240	250	125
300 **)	320	-
220-440	500	250
600 **)	630	-
480-960	1000	500
1000 **)	1000	-

- 1) The line-to-earth insulation level for unearthed or impedance-earthed lines is equal to that between lines (phases), because the operating voltage of any line (phase) can, in practice, approach full voltage between lines (phases) [line voltage]. This is because the actual voltage to earth is determined by the insulation resistance and by the capacitive reactance of each line-to-earth. Consequently, a low (but acceptable) insulation resistance of a line can, in effect, earth it and increase voltage to earth of the other two phases at full voltage between the lines [line voltage].
- 2) For equipment for use on both three-phase three-wire and three-phase four-wire AC systems, earthed or unearthed, use only the values for three-wire systems.

\*) It is assumed that the rated voltage of the equipment is not less than this value.

\*\*\*) These values correspond to the values given in Table F.1.

Usually for three-phase systems with 230/400 V nominal voltage, the conventional line-to-line insulation voltage is 400 V and the line-to-earth for TT or TN systems is 250 V.

For three-phase systems with 400 V or 500 V nominal voltage, the conventional line-to-line insulation voltage is respectively 400 V and 500 V.

The pollution degree must be specified according to IEC 60664-1.

This strongly influences the **rated insulation voltage** of a connector. Therefore, the rated insulation voltage of a connector should be reconsidered time by time for each pollution degree.

**TABLE F.3b**

Three-phase four or three-wire AC systems  
(IEC 60664-1 Ed. 2.0 - 2007-04).

Rated supply voltage <sup>1)</sup>	Rationalised voltages for Table F.4		
	For insulation phase-phase <sup>1)</sup>		For insulation phase-phase <sup>1)</sup>
	All systems	Four-wire three-phase systems with earthed neutral	Four-wire three-phase systems unearthed <sup>1)</sup> or with earthed phase
V	V	V	V
63	63	32	63
110	125	80	125
120	125	80	125
127	125	80	125
150 **)	160	-	160
208	200	125	200
220	250	160	250
230	250	160	250
240	250	160	250
300 **)	320	-	320
380	400	250	400
400	400	250	400
415	400	250	400
440	500	250	500
480	500	320	500
500	500	320	500
575	630	400	630
600 **)	630	-	630
660	630	400	630
690	630	400	630
720	800	500	800
830	800	500	800
960	1000	630	1000
1000 **)	1000	-	1000

With this rationalized voltage value, the pollution degree and the material group the minimum creepage distance can be determined using **Table F.4**.

**TABLE F.4**

 Creepage distances to avoid failure due to tracking  
 [IEC 60664-1 Ed.2.0 (2007-04)].

Effective voltage <sup>1)</sup> V	Minimum creepage distances								
	Materials for printed circuits			Pollution degree					
	1	2	1	2			3		
	All material groups	All material groups except IIIb	All material groups	Material group I	Material group II	Material group III	Material group I	Material group II	Material group III <sup>2)</sup>
V	mm	mm	mm	mm	mm	mm	mm	mm	mm
10	0,0250	0,040	0,080	0,400	0,400	0,400	1,000	1,000	1,000
12.5	0,0250	0,040	0,090	0,420	0,420	0,420	1,050	1,050	1,050
16	0,0250	0,040	0,100	0,450	0,450	0,450	1,100	1,100	1,100
20	0,0250	0,040	0,110	0,480	0,480	0,480	1,200	1,200	1,200
25	0,0250	0,040	0,125	0,500	0,500	0,500	1,250	1,250	1,250
32	0,0250	0,040	0,14	0,53	0,53	0,53	1,30	1,30	1,30
40	0,0250	0,040	0,16	0,56	0,80	1,10	1,40	1,60	1,80
50	0,0250	0,040	0,18	0,60	0,85	1,20	1,50	1,70	1,90
63	0,0400	0,063	0,20	0,63	0,90	1,25	1,60	1,80	2,00
80	0,0630	0,100	0,22	0,67	0,95	1,30	1,70	1,90	2,10
100	0,1000	0,160	0,25	0,71	1,00	1,40	1,80	2,00	2,20
125	0,1600	0,250	0,28	0,75	1,05	1,50	1,90	2,10	2,40
160	0,2500	0,400	0,32	0,80	1,10	1,60	2,00	2,20	2,50
200	0,4000	0,630	0,42	1,00	1,40	2,00	2,50	2,80	3,20
250	0,5600	1,000	0,56	1,25	1,80	2,50	3,20	3,60	4,00
320	0,75	1,6	0,75	1,60	2,20	3,20	4,00	4,50	5,00
400	1,0	2,0	1,0	2,0	2,8	4,0	5,0	5,6	6,3
500	1,3	2,5	1,3	2,5	3,6	5,0	6,3	7,1	8,0 (7,9) <sup>4)</sup>
630	1,8	3,2	1,8	3,2	4,5	6,3	8,0 (7,9) <sup>4)</sup>	9,0 (8,4) <sup>4)</sup>	10,0 (9,0) <sup>4)</sup>
800	2,4	4,0	2,4	4,0	5,6	8,0	10,0 (9,0) <sup>4)</sup>	11,0 (9,6) <sup>4)</sup>	12,5 (10,2) <sup>4)</sup>
1.000	3,2	5,0	3,2	5,0	7,1	10,0	12,5 (10,2) <sup>4)</sup>	14,0 (11,2) <sup>4)</sup>	16,0 (12,8) <sup>4)</sup>
1.250			4,2	6,3	9,0	12,5	16,0 (12,8) <sup>4)</sup>	18,0 (14,4) <sup>4)</sup>	20,0 (16,0) <sup>4)</sup>
1.600			5,6	8,0	11,0	16,0	20,0 (16,0) <sup>4)</sup>	22,0 (17,6) <sup>4)</sup>	25,0 (20,0) <sup>4)</sup>
2.000			7,5	10,0	14,0	20,0	25,0 (20,0) <sup>4)</sup>	28,0 (22,4) <sup>4)</sup>	32,0 (25,6) <sup>4)</sup>
2.500			10,0	12,5	18,0	25,0	32,0 (25,6) <sup>4)</sup>	36,0 (28,8) <sup>4)</sup>	40,0 (32,0) <sup>4)</sup>
3.200			12,5	16,0	22,0	32,0	40,0 (32,0) <sup>4)</sup>	45,0 (36,0) <sup>4)</sup>	50,0 (40,0) <sup>4)</sup>
4.000			16,0	20,0	28,0	40,0	50,0 (40,0) <sup>4)</sup>	56,0 (44,8) <sup>4)</sup>	63,0 (50,4) <sup>4)</sup>
5.000			20,0	25,0	36,0	50,0	63,0 (50,4) <sup>4)</sup>	90,0 (56,8) <sup>4)</sup>	100,0 (64,0) <sup>4)</sup>
6.300			25,0	32,0	45,0	63,0	80,0 (64,0) <sup>4)</sup>	110,0 (72,0) <sup>4)</sup>	125,0 (80,0) <sup>4)</sup>
8.000			32,0	40,0	56,0	80,0	100,0 (80,0) <sup>4)</sup>	140,0 (88,0) <sup>4)</sup>	160,0 (100,0) <sup>4)</sup>
10.000			40,0	50,0	71,0	100,0	125,0 (100,0) <sup>4)</sup>	140,0 (112,0) <sup>4)</sup>	160,0 (128,0) <sup>4)</sup>
12.500			50,0 <sup>3)</sup>	63,0 <sup>3)</sup>	90,0 <sup>3)</sup>	125,0 <sup>3)</sup>			
16.000			63,0 <sup>3)</sup>	80,0 <sup>3)</sup>	110,0 <sup>3)</sup>	160,0 <sup>3)</sup>			
20.000			80,0 <sup>3)</sup>	10,0 <sup>3)</sup>	140,0 <sup>3)</sup>	200,0 <sup>3)</sup>			
25.000			10,0 <sup>3)</sup>	125,0 <sup>3)</sup>	180,0 <sup>3)</sup>	250,0 <sup>3)</sup>			
32.000			125,0 <sup>3)</sup>	160,0 <sup>3)</sup>	220,0 <sup>3)</sup>	320,0 <sup>3)</sup>			
40.000			160,0 <sup>3)</sup>	200,0 <sup>3)</sup>	280,0 <sup>3)</sup>	400,0 <sup>3)</sup>			
50.000			200,0 <sup>3)</sup>	250,0 <sup>3)</sup>	360,0 <sup>3)</sup>	500,0 <sup>3)</sup>			
63.000			250,0 <sup>3)</sup>	320,0 <sup>3)</sup>	450,0 <sup>3)</sup>	600,0 <sup>3)</sup>			

1) This voltage is

- for functional insulation, the working voltage,
- for basic and supplementary insulation of the circuit energized directly from the supply mains (see 4.3.2.2.1), the voltage rationalized through Table F.3a or Table F.3b, based on the rated voltage of the equipment, or the rated insulation voltage,
- for basic and supplementary insulation of systems, equipment and internal circuits not energized directly from the mains (see 4.3.2.2.2), the highest r.m.s. voltage which can occur in the system, equipment or internal circuit when supplied at rated voltage and under the most onerous combination of conditions of operation within equipment rating.

2) Material group IIIb is not recommended for application in pollution degree 3 above 630 V.

3) Provisional data based on extrapolation. Technical committees who have other information based on experience may use their dimensions.

4) The values given in brackets may be applied to reduce the creepage distance in case of using a rib (see 5.2.5).

**NOTE** – The high precision used in indicating creepage distances in this table does not mean that the uncertainty of measurement has to be of the same order of magnitude.

 In **boldface** the typical values for multipole rectangular connectors for industrial uses are shown.



## EU environmental legislation

### RoHS 2 (2011/65/EU) and WEEE 2 (2012/19/EU) Directives

The **RoHS 2 2011/65/EU Directive** (recast) replaced on 2013-01-03 the original RoHS 2002/95/EC Directive (with its later amendment 2008/35/EC).

This Directive introduced the ban of use of certain hazardous substances in new electrical and electronic equipment (end products) placed on the market from 1st of July 2006 (the exceptions for some applications were listed in Annex of the Directive and in a number of further Decisions of the EU Commission<sup>1</sup>). Indirectly – in the supply chain – the ban also applied to the electrical components of said electrical and electronic equipment.

The banned and/or restricted substances originally were:

**Lead (Pb)** (0,1 %), **Mercury (Hg)** (0,1 %), **Cadmium (Cd)** (0,01 %), **Hexavalent Chromium (Cr<sup>6+</sup>)** (0,1 %), **Poly-brominated biphenyls (PBB)** (0,1 %) and **Poly-brominated diphenyl ethers (PBDE)** (0,1 %) (the latter two being families of flame retardants for thermoplastic materials)

to which the **Commission Delegated Directive 2015/863/EU** of 2015-03-31 added – with a period of grace of six and a half years – the following ones:

**Bis(2-ethylhexyl) phthalate (DEHP)** (0,1 %), **Butyl benzyl phthalate (BBP)** (0,1 %), **Dibutyl phthalate (DBP)** (0,1 %), **Diisobutyl phthalate (DIBP)** (0,1 %).

All ILME finished products (industrial electrical equipment) as well as all ILME components (for industrial electrical equipment) in the sense of the Directive are in conformity with the **RoHS 2 2011/65/EU Directive and all subsequent modifications** within the terms of its scope and the starting dates (transitional periods) established for each category of EEE (electrical and electronic equipment) covered in Annex I of said Directive.

For all components (connector inserts, removable crimp contacts, enclosures for connectors, and accessories related to connectors as far as they are in the scope) the products comply with the limit values for certain substances as set out in said RoHS 2 2011/65/EU Directive and all subsequent modifications, including the permitted exemptions of Annexes III and IV.

NOTE – Such products by themselves – as components – are not covered by the RoHS 2 Directive; therefore, for such products, there are no direct legal requirements. As no EU Declaration of Conformity can be issued, the above does not constitute a EU Declaration of Conformity to the RoHS 2 2011/65/EU Directive, and the CE marking – which may be applied either on the part or on the packaging label in compliance with other applicable EU Directives, e.g. the Low Voltage Directive 2014/35/EU (a recasting of the previous directive 2006/95/EC in force from 2016-04-20) – is not referred to said RoHS 2 Directive.

The **WEEE 2 2012/19/EU Directive** (recast) replaced on 2014-02-15 the original WEEE 2002/96/EC Directive (and its later amendments 2003/108/EC and 2008/34/EC). Its last update is **Directive 2018/849/EU** of 2018-05-30. This Directive aims to recycle and minimise Waste from Electrical and Electronic Equipment (also referred to as WEEE). It encourages recycling, reuse and other forms of recovery of such technological waste and sets ambitious targets for recovery rate, variable depending on the product categories.

<sup>1</sup> At the date of withdrawal of the old RoHS 2002/95/EC Directive – 2013-01-03 – the following Commission decisions were applicable: **M1** 2005/618/EC of 18th August 2005, **M2** 2005/717/EC of 13th October 2005, **M3** 2005/747/EC of 21st October 2005, **M4** 2006/310/EC of 21st April 2006, **M5** 2006/690/EC, **M6** 2006/691/EC and **M7** 2006/692/EC of 12th October 2006, **M9** 2008/385/EC of 24th January 2008, **M10** 2009/428/EC of 4th June 2009, **M11** 2009/443/EC of 10th June 2009, **M12** 2010/122/EU of 25th February 2010, **M13** 2010/571/EU of 24th September 2010, **M14** 2011/534/EC of 8th September 2011.

In the new Directive, a six-year **transitional period** was established up to 2018-08-14, during which the equipment included in its “open scope” still remained the same as per the former WEEE Directive. From 15th August 2018, the scope became “open”, subject to the exclusions for various categories of “equipment”, which include the **large-scale fixed installations**. These are defined as “a large-size combination of several types of apparatus and, where applicable, other devices, which: (i) are assembled, installed and uninstalled by professionals; (ii) are intended to be used permanently as part of a building or a structure at a pre-defined and dedicated location; and (iii) can only be replaced by the same specifically designed equipment” and large-scale stationary industrial tools defined as “a large size assembly of machines, equipment, and/or components, functioning together for a specific application, permanently installed and uninstalled by professionals at a given place, and used and maintained by professionals in an industrial manufacturing facility or research and development facility”.

**Connectors and their accessories** that, as components, are outside the scope of RoHS 2 Directive, do not fall in the scope of WEEE 2 even once “open scope”; moreover, they are primarily used in installations of industrial automation (large-scale stationary industrial tools) which are exempted from conformity to the WEEE 2 Directive.

As required by the WEEE 2 Directive, ILME will take care of any technical and administrative obligation for any ILME product that might be involved.

As a manufacturer of electrical equipment and components for industrial use, ILME acknowledges the regulations introduced by these Directives. The above-mentioned Directives are already effective national law in all EU countries. Similar regional regulations aimed at the preservation of the environment are in force across the world outside Europe.

For the products described in this Catalogue, although the restrictions of use of the above mentioned hazardous substances are not legally applicable, in that no product in this Catalogue belongs to any of the product categories described and illustrated in the above mentioned RoHS 2 and WEEE 2 Directives, the “**RoHS conformity**” is important, as it is required downstream in the supply chain. ILME has therefore carried out the necessary corrective actions, which have led to the “**RoHS conformity**” of all products in this Catalogue, wherever required.

**ILME products sold after 1st July 2006 do not contain any of the restricted substances in concentrations higher than those allowed by the RoHS 2 Directive and by the subsequent related Decisions taken by the EU Commission.**

# Fire protection standards for railway applications

The European standard EN 45545 governing fire protection on railway vehicles was published in 2013. In Italy, the various parts are:

- **UNI CEI EN 45545-1:2013-05** Railway applications – Fire protection on railway vehicles – Part 1: General;
- **UNI CEI EN 45545-2:2013-05** Railway applications – Fire protection on railway vehicles – Part 2: Requirements for fire behaviour of materials and components;
- **UNI CEI EN 45545-3:2013-05** Railway applications – Fire protection on railway vehicles – Part 3: Fire resistance requirements for fire barriers;
- **UNI CEI EN 45545-4:2013-05** Railway applications – Fire protection on railway vehicles – Part 4: Fire safety requirements for rolling stock design;
- **UNI CEI EN 45545-5:2013-05** Railway applications – Fire protection on railway vehicles – Part 5: Fire safety requirements for electrical equipment, including that of trolley buses, track guided buses and magnetic levitation vehicles;
- **UNI CEI EN 45545-6:2013-05** Railway applications – Fire protection on railway vehicles – Part 6: Fire control and management systems;
- **UNI CEI EN 45545-7:2013-05** Railway applications – Fire protection on railway vehicles – Part 7: Fire safety requirements for flammable liquid and flammable gas installations.

The standard replaces the previous voluntary Technical Specification CEN/TS 45545:2009 and has formalised the withdrawal of all conflicting national standards as of 1st April 2016, the date on which the following parallel standards cease to be effective: in Italy **UNI CEI 11170-1:2005**, **UNI CEI 11170-2:2005** and **UNI CEI 11170-3:2005**; in France, **NF F 16-101:1988** and **NF F 16-102:1992**; in Germany, **DIN 5510-2:2009**; in United Kingdom, **BS 6853:1999**. These, however, remained applicable until 31st march 2016. All certificates covering materials issued in line with national standards remained valid in Europe up until this date. As of 1st April 2016, the only reference standard is EN 45545:2013. However, due to the huge number of customer specifications and technical documents making reference to obsolete standards, the railway business is still moving to a complete unification to the EN 45545 series.

**EN 45545-2** specifies the requirements for the fire behaviour of materials and components of railway vehicles according to the different hazard levels defined by EN 45545-1:2013 (HL = Hazard Level). See Table 1 – Classification of hazard levels (EN 45545-2:2013).

**Table 1 – Hazard level classification (EN 45545-2:2013)**

Operation Category (#)	Design Category			
	A: Vehicles forming part of an automatic train having no emergency trained staff on board	D: Double decked vehicles	S: Sleeping and couchette vehicles	N: All other vehicles (standard vehicles)
OC 1	HL1	HL1	HL2	HL1
OC 2	HL2	HL2	HL2	HL2
OC 3	HL2	HL2	HL3	HL2
OC 4	HL3	HL3	HL3	HL3

(#) Relationship between the service, the infrastructure and the conditions for the evacuation of passengers and staff

Each hazard level provides for its own specific test procedures, test conditions, fire protection requirements and severity (min or max threshold), ranging from **R1** to **R26**. Electrical components of small size and mass, such as electrical connectors, shall have a nominal fire behaviour rating (self-extinguishing) **94V-0 (standard UL 94)**.

The thermoplastic insulating material used in ILME connectors complies with the requirements of UL 94V-0. There are no requirements applicable to products with a combustible mass < 10 g not in contact with other unclassified products, if they are installed adjacent to components for which no certificates are available. In this case, the requirements depend on the so-called grouping rules.

Connectors are unlisted products in Table 2 of EN 45545-2:2013. As non-listed products, they must satisfy the requirements of Table 3, and as their exposed surface area is  $\leq 0,2 \text{ m}^2$ , the set of requirements for indoor location in a railway vehicle is R22 while for outdoor location it is R23 (Table 5 of EN 45545-2:2013).

For the materials of connectors, these are the sets of maximum applicable requirements. These sets establish parameters, procedures and limit thresholds (min or max) for the tests. In particular, R22 and R23 specify tests and limit values for **oxygen content** (oxygen index OI), **smoke density** (Ds max) and **toxicity** (conventional toxicity index CIT<sub>NLP</sub>).

**The polycarbonate used by ILME in its connectors meets the limit values specified in EN 45545-2.**

See Table 2 – Requirements for unlisted products (including electrical connectors) – at following page.

Until the publication of the previously mentioned series of European standards, the most advanced fire safety standards for the railway industry were French:

- **NF F 16-101** Matériel roulant ferroviaire – Comportement au feu–Choix des matériaux;
- **NF F 16-102** Matériel roulant ferroviaire – Comportement au feu –Choix des équipements électriques;

which in turn referred to the test methods described in standards:

- **NF X 70 100** Analyse de gaz de pyrolyse et de combustion;
- **NF X 10 702** Détermination de l'opacité des fumées en atmosphère renouvelée.



**Table 2 – Requirements for unlisted products (including electrical connectors)**

Test method	Standard	Parameter	Unit	Interior	Exterior	R22 thresholds (more severe than R23)			ILME (polycarbonate)
Oxygen index OI	EN ISO 4589-2	OI (min)	%	R22	R23	HL1: 28	HL2: 28	HL3: 32	better than R22-HL3
Smoke density	EN ISO 5659-2	D <sub>s</sub> max <sup>(1)</sup>	---	R22	R23	HL1: 600	HL2: 300	HL3: 150	better than R22-HL3
Toxicity of smoke	NF X70-100-1 NF X70-100-2	CIT <sub>NLP</sub> (max) <sup>(2)</sup>	---	R22	R23	HL1: 1,2	HL2: 0,9	HL3: 0,75	better than R22-HL3
<sup>(1)</sup> D <sub>s</sub> max = maximum specific optical density of smoke									
<sup>(2)</sup> CIT <sub>NLP</sub> (max) = maximum conventional index of toxicity of smoke									

These latter were somewhat similar, in terms of methods, to the American standards:

- **ASTM E 662** Standard Test Method for Specific Optical Density of Smoke Generated by Solid Materials;
- **ASTM E 162** Standard Test Method for Surface Flammability of Materials Using a Radiant Heat Energy Source.

Test methods referred to in the American reference standard specifying the performance criteria:

- **NFPA 130** Standard for Fixed Guideway Transit and Passenger Rail Systems.

Also widely used are the Bombardier Transportation smoke toxicity specifications:

- **SMP 800-C** Toxic Gas Generation.

In Italy, from 2006 to 31st March 2016, for installation on board railway vehicles, a certificate of conformity to the following Italian railway standards was required:

- **UNI CEI 11170-1:2005** Trains and trams – Fire safety guidelines for trains, trams and track guided vehicles – General principles;
- **UNI CEI 11170-2:2005** Trains and trams – Fire safety guidelines for trains, trams and track guided vehicles – Design recommendations – Fire containment measures – Indication, monitoring and evacuation systems;
- **UNI CEI 11170-3:2005** Trains and trams – Fire safety guidelines for trains, trams and track guided vehicles – Material fire behaviour assessment – Acceptance limits

published jointly by UNI and CEI on 2005-11-30 with parallel validity until 31st March 2016. In these standards, the requirements for materials relating to electrical connectors are contained in the 2nd schedule “Acceptability criteria for electrical and electronic materials and components” at the application “All other applications including flammable materials” (all applications other than electric cables). For these applications, four material tests are required:

- Exposure to a small flame according to EN ISO 11925-2 with, depending on the level of risk, a resistance to fire of the material of 15 s for LR1 and LR2 and a resistance of 30 s for LR3 and LR4.

- Smokiness in compliance with French standard NF F 16-101 with IF better or equal to F2 for all risk levels. The material we use is classified as F1 (better than F2) according to the tests carried out.

- Smoke optical density measurement, in compliance with French standard NF X 10-702 (from NF F 16-101) with values ≤ 100 for all risk levels LR1...4.

- Toxicity measurement, in compliance with Italian standard CEI 20-37/7, with T ≤ 2 for all risk levels LR1...4.

**Tests**

**EU** – The material tested in accordance with the European Norm **EN 45545-2:2013** – showed an oxygen index (OI) of 38%, a D<sub>s</sub> max (flaming) = 117 and a smoke toxicity index CITNLP = 0,16, **compliant with the requirements of EN 45545-2:2013 for all risk levels: HL1 – HL2 – HL3** and, consequently, for all the design categories (A, D, S, N) and operation categories (1, 2, 3, 4) defined in EN 45545-1:2013.

**France** - The material used in our connectors is certified by an accredited laboratory CERTIFER, according to the previously mentioned French standards **NF F 16-101** and **NF F 16-102**, and has a **classification F1** (Index Fumée I.F. = 15) and a smoke toxicity index (Index Toxicité Fumée) **I.T.C. = 18**.

Both values meet the requirements set out by the French standards and by the Italian standard UNI CEI 11170-3 schedule 2, which relates to electrical connectors.

**Germany** – The material used in our connectors also complies with the German standard **DIN 5510-2:2009** with a **flammability class = S4**, **smoke spreading class = SR2** and **drip class = ST2**.

**UK** - The material was also tested according to British Standard **BS 6853:1999**, with an **R (max) index = 0,6**, consequently within the limits of Tables 7 and 8 of the standard for vehicle categories Ia, Ib and II.

**USA** - Tests compliant with American standards have also been carried out at a qualified North American laboratory, confirming compliance with the requirements set out by the US Federal Transit Administration “Recommended Fire Safety Practices for Rail Transit Material Selection” for methods ASTM E 662 (NFPA 258) (specific optical smoke density), ASTM E 162 (ASTM D 3635) (surface flammability → flame propagation index) and Bombardier Transportation SMP 800-C (smoke and gas toxicity).

## Standards and Certifications

### cUL US mark

ILME enclosures have been certified by UL as Recognised Components for the USA and Canada (cUL mark) as accessories of our set of UL and CSA certified connector inserts (file UL E115072, file CSA 082270\_0\_000).

The certification has been achieved by successfully completing several tests carried out in compliance with standard **ANSI/UL 50** (Enclosures for Electrical Equipment) which is equivalent to the North American voluntary standard **NEMA 250** (NEMA = National Electrical Manufacturers Association) and to the equivalent Canadian standard **CSA C22.2 No.94** (Special Purpose Enclosures) for safety levels used in North America and required by the local installation codes (e.g.: NFPA 70 National Electrical Code in the US, CSA system standards for Canada); more specifically:

- **Type 12** (= NEMA 12): for internal use, similar to IP54 protection rating according to IEC/EN 60529; it covers Type 1 and Type 2.
- **Type 4** (= NEMA 4): for internal and external use, similar to IP66.
- **Type 4X** (= NEMA 4X): for internal and external use, as Type 4 + corrosion resistance, similar to IP66 protection rating.

The certification includes the enclosure series with ISO, Pg and metric cable entry as well as NPT, all special versions similar to standard types.



## Specifications



### Connectors compliant with DESINA® standard

DESINA® (which stands for DEcentralised and Standardised INstallation technology) is an innovative installation concept behind a study headed by the German manufacturers of machine tools association (VDW), with the co-operation of users (including German automotive manufacturers) and component manufacturers, which has led to the introduction of a specification aimed to standardise electrical, hydraulic and pneumatic components and their interconnection on common platform for CNC controlled machine tools and manufacturing lines.

In the last few years, the DESINA® specification has been successfully enclosed in the ISO TC 184/SC 1 "Industrial automation systems and integration / Physical device control" as an ISO standard.

This work has been completed, and the following standards have now become available:

**ISO 23570-1** Industrial automation systems and integration – Distributed installation in industrial applications: Part 1 – Sensors and actuators.

**ISO 23570-2** Industrial automation systems and integration – Distributed installation in industrial applications: Part 2 – Hybrid communication bus.

**ISO 23570-3** Industrial automation systems and integration – Distributed installation in industrial applications: Part 3 – Power distribution bus.



### EUROMAP (European Plastics and Rubber Machinery)

ILME connectors meet the Technical Recommendations:

- EUROMAP 12: CSAH / CDA / CDC inserts, 32 poles.
- EUROMAP 13: CSAH / CDA / CDC inserts, 16 poles.
- EUROMAP 14 – part 1: CSAH / CDA / CDC inserts, 16 poles (with CDC inserts the iron and constantan thermocouple crimp contacts may also be used).
- EUROMAP 14 – part 2: CSH / CNE / CCE / CSE inserts, 16 poles
  - CP inserts, 6 poles.
- EUROMAP 16: CD inserts, 8 poles, CSAH / CDA / CDC inserts, 10 poles.
- EUROMAP 27-1: MIXO inserts, CX 08 C and CX 04 B.
- EUROMAP 28: CSH / CSE inserts, 6 poles.
- EUROMAP 29: CSH / CSE inserts, 24 poles.
- EUROMAP 62: CSAH / CDA / CDC inserts, 32 poles.
- EUROMAP 67: CD inserts, 50 poles (CD 25 Z version).
- EUROMAP 67.1: CD inserts, 50 poles (CD 25 Z version).
- EUROMAP 70: MIXO inserts, CX 12 D.
- EUROMAP 71: CD inserts, 50 poles (CD 25 Z version).
- EUROMAP 73: MIXO inserts, CX 12 D.
- EUROMAP 74: MIXO inserts, CX 12 D.
- EUROMAP 78: MIXO inserts, CX 12 D.

Visit [ilme.com](http://ilme.com) and watch our Configurator video to discover how easy is to design your connector in real time.

**Get into ILME Configurator**

Design your own connector in real time

**Search, choose, download!**

Watch our configurator movie

Welcome to ILME

Ilme Smart Configurator is a dynamic tool to digital access and match our database of over 7.000 product codes.





## search

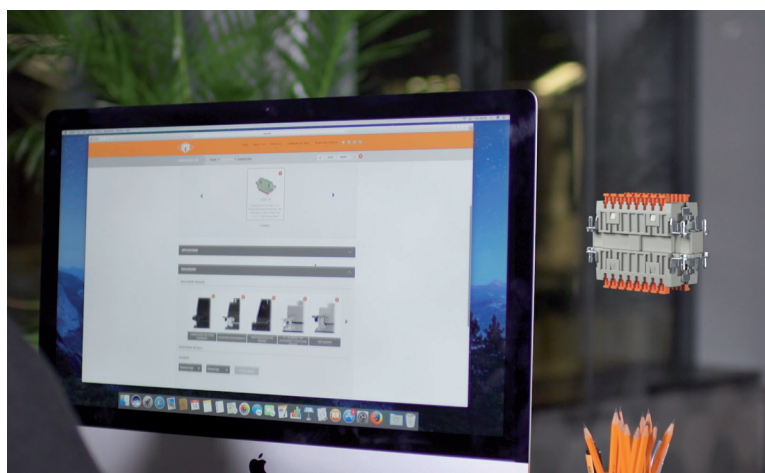

Over 50 million of online connector combinations.

## choose

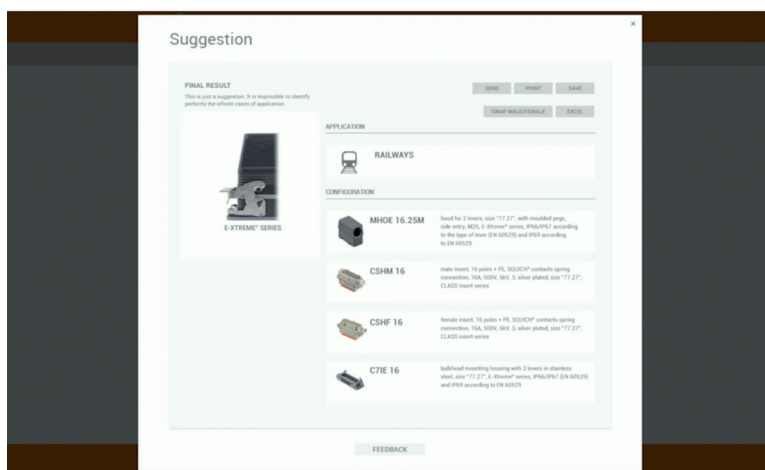

Easy selection of individual parts for key applications and recommendations for custom environmental conditions.

## download

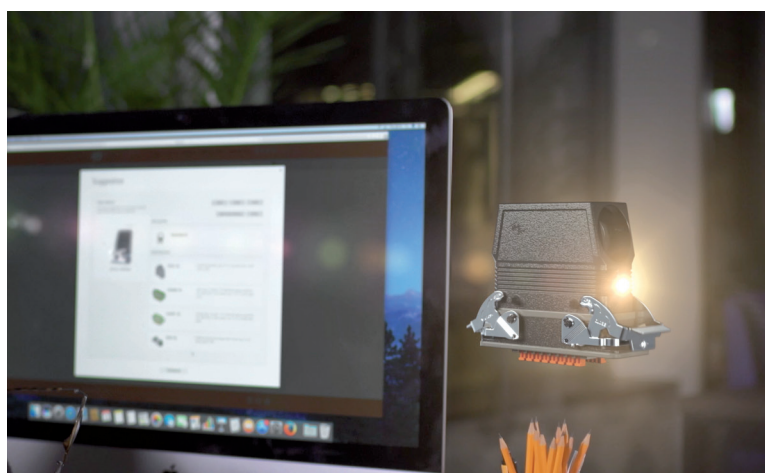

Smart suggestion to get the most suitable configuration.

# Worldwide Sales Organization

<b>Headquarters</b>	<b>ILME S.p.A.</b> Via M.A. Colonna, 9 20149 Milano, Italia T +39 0234560522 info@ilme.com
<b>France</b>	<b>ILME FRANCE S.A.R.L.</b> Rue Roland Garros Parc d'Activités de l'Aéroport 42160 Andrézieux-Bouthéon T +33 04 7736 2336 ilme-france@ilme.fr
<b>Germany</b>	<b>ILME GmbH</b> Max-Planck-Straße 12 51674 Wiehl T +49 (0)2261 7955 0 technik@ilme.de
<b>Sweden and Nordic Countries</b>	<b>ILME NORDIC AB</b> Transportvägen 18 246 42 Löddeköpinge T +46 4618 2800 info@ilme.se
<b>United Kingdom</b>	<b>ILME UK LIMITED</b> 50 Evans Road, Venture Point Speke, Liverpool L24 9PB T +44 0151 336 9321 sales@ilmeuk.co.uk
<b>China</b>	<b>ILME CHINA CO. LTD.</b> Room 101, Building 3, 188 Xinjunhuan Road, Minhang Shanghai 201114 T +86 21 6248 9961 info@ilmechina.com
<b>Japan</b>	<b>ILME JAPAN CO. LTD.</b> K.I.B.C. Bldg 5-2, Minatojima Minamimachi 5-Chome, Chuo-Ku, Kobe 650-0047 T +81 78 302 2005 info@ilmejapan.co.jp



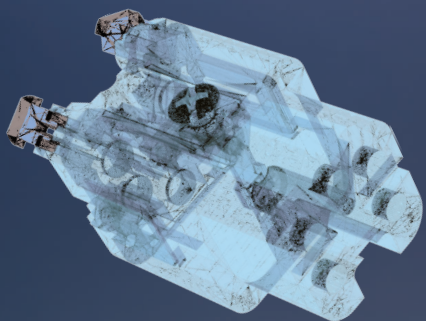
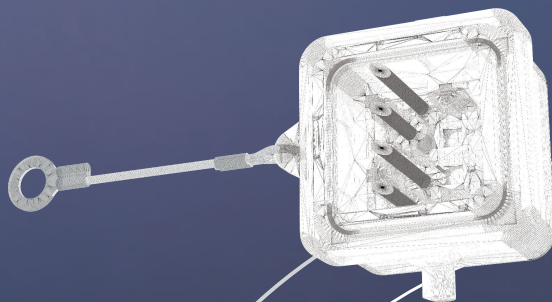

**ILME S.p.A.**  
Via M.A. Colonna 9  
20149 Milano, Italy  
[www.ilme.com](http://www.ilme.com)



catalogues

XDG CN 419