

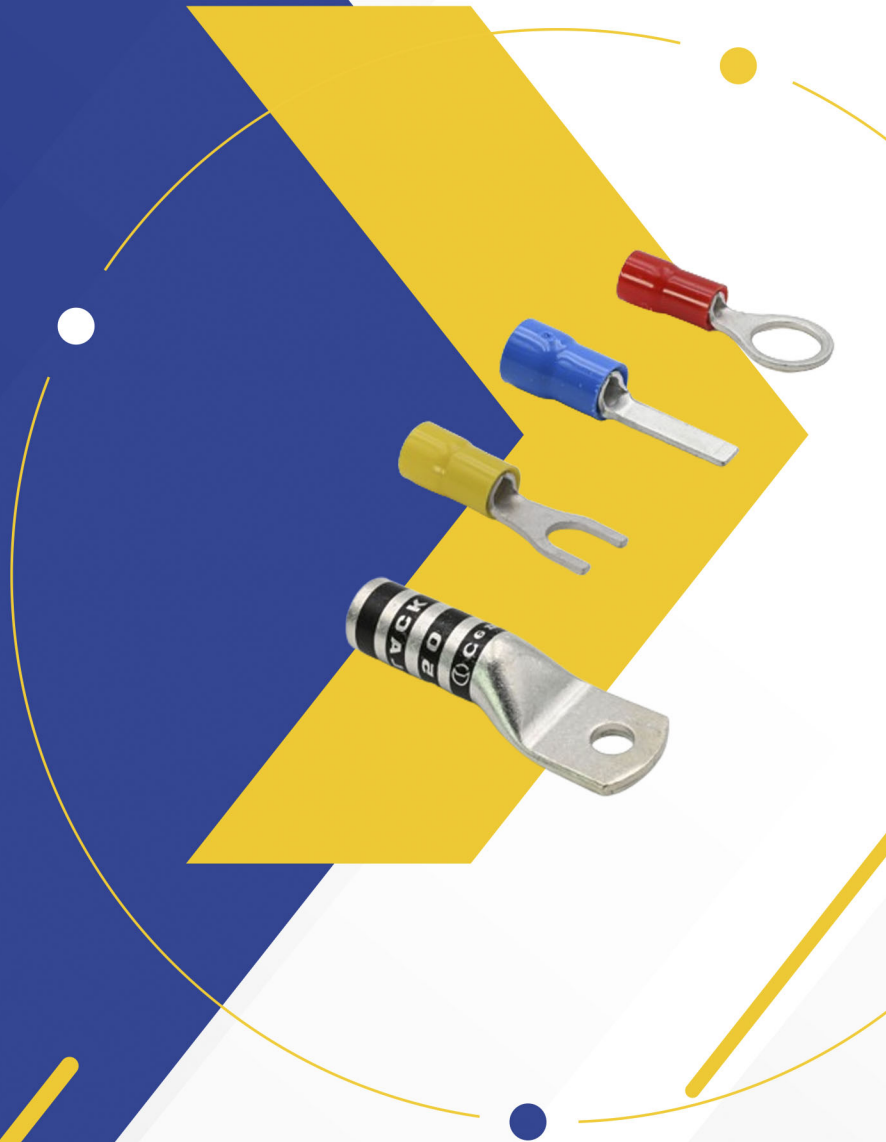

ELECTRICAL COMPONENTS

Wire Termination

- Solderless Crimp Terminals
- Power Crimp Terminals
- Ferrules
- Assortment Kits
- Crimp Tools

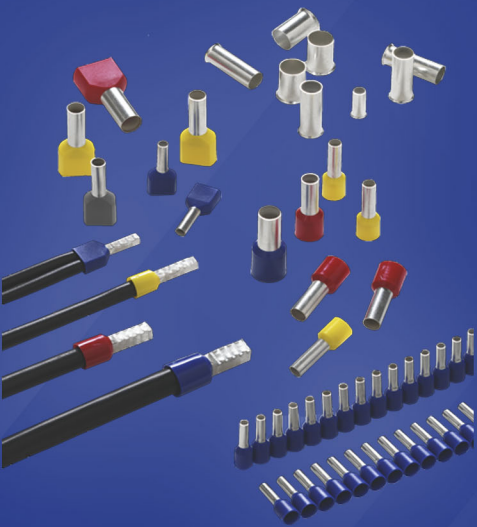

Wire Termination Products

This catalog features a wide range of devices used to terminate wires and cables for safe, professional, reliable and durable connection to most types of terminals found in control components and panels, machinery, power distribution and grounding.

- **Solderless (Crimp) Terminals:**

Non-insulated and insulated copper terminals in a variety of styles (ring, spade, pin, blade, disconnect, splice, and more) for wires and cables from 0.14-25mm² (26AWG-4AWG). Selected non-insulated high-temperature terminals are also included.



Approvals: CSA # 028418, 083574
cULus # E128651, E96029

- **Power Crimp Terminals:**

Non-insulated color-coded copper lugs and splices for cables from 10mm² -400mm² (8AWG-750MCM).

Nylon insulated copper solderless ring 10-50mm² (8-1/0AWG), and spade terminals from 10-16mm² (8-6AWG).

Non-insulated (tubular) copper solderless ring, spade and flat terminals from 10-50mm² (8-1/0AWG).



Approvals: cULus # E125401

- **Ferrules:**

Cord end copper connectors for termination of stranded wires and cables from 0.14-240mm² (26-500MCM).

Available in the following types: non-insulated, insulated, twin insulated, extra insulated, and in strips, spools and rolls for automated application.



Approvals: CSA # 242724
cULus # E485383

- **Tools:**

Tools for application of the terminals above, while briefly described in this catalog, can be found in detail - in specific ITC flyers and catalogs.

Table of Contents

Solderless (Crimp) Terminals	4
Ring terminals	4
Locking spade terminals	4
Spade (fork) terminals	5
Flanged spade terminals	5
Hook terminals	6
Butt splices	6
Parallel splices	6
Female disconnects	7
Male disconnects (tabs)	7
Flag disconnects	8
Piggyback disconnects	8
Closed end crimp connectors	8
Female bullet connectors	9
Male bullet connectors	9
Pin terminals	9
Blade & lipped blade terminals	10
Quick splice with disconnect	10
Terminals on tape (spools)	10
Heat shrink butt splices	11
High temperature solderless crimp terminals	12
Solderless crimp terminal kits	13
Solderless crimp terminal slide-box kits	14
Colour-coded power crimp terminals	15
Colour-coded butt splices type '39BSCL'	15
Colour-coded power lugs '39C' (standard length)	16
Colour-coded power lugs '39CL' (1 hole-long barrel)	18
Colour-coded power lugs '39CL-D' (2 holes)	19
Power crimp (solderless) terminals	20
Ferrules	22
Non-insulated ferrules	22
Single insulated ferrules	23
Twin insulated ferrules	24
Single insulated ferrules in strips, spools and rolls	24
Short-circuit protection insulated ferrules	25
Ferrule dispenser boxes	26
Ferrule kits in plastic or metal cases	26
Ferrule slide-box kits	27
Crimping Tools	28
AWG to Metric Equivalent (Wire Diameters)	31

Solderless (Crimp) Terminals

Ring Terminals (Order by Part No.)

Range AWG Colour mm ²	Stud Size	Part Number					Pack	Tool	
		Non-Insulated (brazed seam)	Vinyl Insulated	Nylon Insulated	Poly- carbonate Insulated				
26 – 22AWG yellow 0.14 – 0.34mm ²	2			321.000			100	504.821	
	3			321.001					
	4			321.002					
	6			321.003					
	8			321.004					
	10			321.005					
22 – 16AWG red 0.34 – 1.5mm ²	3						100	Non- insulated 504.842 504.931 504.942	
	4	301.012		311.012					
	6	301.013		311.013	331.013				
	8	301.014		311.014	321.014				331.014
	10	301.015		311.015	321.015				331.015
	¼"	301.016		311.016	321.016				331.016
	5/16"	301.017		311.017					
	3/8"	301.018		311.018					
1/2"			311.019						
16 – 14AWG blue 1.5 – 2.5mm ²	4	301.022		311.022			100	Insulated 500.064 504.921	
	6	301.023		311.023	321.023				331.023
	8	301.024		311.024	321.024				331.024
	10	301.025		311.025	321.025				331.025
	¼"	301.026		311.026	321.026				331.026
	5/16"	301.027		311.027					
	3/8"	301.028		311.028					
	1/2"			311.029					
12 – 10AWG yellow 4 – 6mm ²	6	301.033		311.033	321.033		50	Non- insulated 504.931 Insulated 504.921	
	8	301.034		311.034	321.034				331.034
	8	301.034L							
	10	301.035		311.035	321.035				331.035
	¼"	301.036		311.036	321.036				331.036
	5/16"	301.037		311.037					331.037
	3/8"	301.038		311.038					
	½"	301.039		311.039					







Information subject to change without notice

Locking Spade Terminals (Order by Part No.)

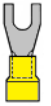
Range AWG Colour mm ²	Stud Size	Part Number			Pack	Tool
		Non-Insulated (brazed seam)		Vinyl Insulated		
22 – 16AWG red 0.34 – 1.5mm ²	6	302.113		312.113	100	Non-insulated 504.842 504.931 504.942
	8	302.114		312.114		
	10	302.115		312.115		
16 – 14AWG blue 1.5 – 2.5mm ²	6	302.123		312.123	100	Insulated 500.064 504.921
	8	302.124		312.124		
	10	302.125		312.125		
12 – 10AWG yellow 4 – 6mm ²	6	302.133		312.133	50	
	8	302.134		312.134		
	10	302.135		312.135		
	¼"	302.136		312.136		

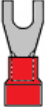





Information subject to change without notice

Spade (Fork) Terminals (Order by Part No.)

Range AWG Colour mm ²	Stud Size	Part Number					Pack	Tool	
		Non-Insulated (brazed seam)		Vinyl Insulated	Nylon Insulated	Poly-carbonate Insulated			
26 – 22AWG yellow 0.14 – 0.34mm ²	2	-	-	-	322.000	-		100	504.821
	3				322.001				
	4				322.002				
	6				322.003				
	8				322.004				
	10				322.005				
22 – 16AWG red 0.34 – 1.5mm ²	4	302.012		312.012	-	-		100	Non-insulated 504.842 504.942 504.931
	6	302.013		312.013	322.013	332.013			
	8	302.014		312.014	322.014	332.014			
	10	302.015		312.015	322.015	332.015			
	¼"	302.016		312.016	322.016	332.016			
16 – 14AWG blue 1.5 – 2.5mm ²	4	302.022		312.022	-	-		100	Insulated 500.064 504.921
	6	302.023		312.023	322.023	332.023			
	8	302.024		312.024	322.024	332.024			
	10	302.025		312.025	322.025	332.025			
	¼"	302.026		312.026	322.026	332.026			
12 – 10AWG yellow 4 – 6mm ²	6	302.033		312.033	322.033	-		50	Non-insulated 504.931 Insulated 504.921
	8	302.034		312.034	322.034	332.034			
	10	302.035		312.035	322.035	332.035			
	¼"	302.036		312.036	322.036	332.036			
	5/16"	302.037		312.037	-	332.037			
	3/8"	302.038		312.038	-	-			
	½"	302.039		-	-	-			







Information subject to change without notice

Flanged Spade Terminals (Order by Part No.)

Range AWG Colour mm ²	Stud Size	Part Number			Pack	Tool	
		Non-Insulated (brazed seam)		Vinyl Insulated			
22 – 16AWG red 0.34 – 1.5mm ²	4	302.212		312.212		100	Non-insulated 504.842 504.931 504.942
	6	302.213		312.213			
	8	302.214		312.214			
	10	302.215		312.215			
16 – 14AWG blue 1.5 – 2.5mm ²	6	302.223		312.223		100	Insulated 500.821 500.064 504.921
	8	302.224		312.224			
	10	302.225		312.225			
12 – 10AWG yellow 4 – 6mm ²	6	302.233		312.233		50	
	8	302.234		312.234			
	10	302.235		312.235			







Information subject to change without notice

Hook Terminals (Order by Part No.)

Range AWG Colour mm ²	Stud Size	Part Number				Pack	Tool
		Non-Insulated (brazed seam)		Vinyl Insulated			
22 – 16AWG red 0.34 – 1.5mm ²	6	302.313		312.313		100	Non-insulated 504.842 504.931 504.942 Insulated 500.064 504.921
	8	302.314		312.314			
	10	302.315		312.315			
	¼"	302.316		312.316			
16 – 14AWG blue 1.5 – 2.5mm ²	6	302.323		312.323		100	
	8	302.324		312.324			
	10	302.325		312.325			
	¼"	302.326		312.326			
12 – 10AWG yellow 4 – 6mm ²	6	302.333		312.333		50	
	8	302.334		312.334			
	10	302.335		312.335			
	¼"	302.336		312.336			
	5/16"	302.337		312.337			







Information subject to change without notice

Butt Splices (Order by Part No.)

Range AWG Colour mm ²	Part Number					Pack	Tool
	Nylon Insulated (straight)		Vinyl Insulated (flared)	Nylon Insulated (flared)			
26 – 22AWG yellow 0.14 – 0.34mm ²	326.100		–	–		100	504.821
22 – 16AWG red 0.34 – 1.5mm ²	326.110		316.310	326.310		100	Non-insulated 504.842 504.931 504.942
16 – 14AWG blue 1.5 – 2.5mm ²	326.120		316.320	326.320		100	
12 – 10AWG yellow 4 – 6mm ²	326.130		316.330*	326.330		50	Insulated 500.821 500.064 504.921

Information subject to change without notice

Parallel Splices (Order by Part No.)

Range AWG Colour mm ²	Part Number				Pack	Tool
	Non- Insulated (brazed seam)		Vinyl Insulated (flared)			
22 – 16AWG red 0.34 – 1.5mm ²	306.210		316.210		100	Non-insulated 504.842 504.931 504.942
16 – 14AWG blue 1.5 – 2.5mm ²	306.220		316.220		100	
12 – 10AWG yellow 4 – 6mm ²	306.230		316.230		50	Insulated 500.821 500.064 504.921

Information subject to change without notice

Female Disconnects (Order by Part No.)

Range AWG Colour mm ²	Tab Size (inches)	Part Number							Pack	Tool	
		Non-Insulated (butted seam)		Vinyl Insulated	Vinyl Fully Insulated (rounded)	Nylon Insulated (rounded)	Nylon Fully Insulated (rounded)	Nylon Fully Insulated (dimpled)			
26 – 22AWG yellow 0.14 – 0.34mm ²	.110x.020	–		314.000	–	–	–	–	Rounded Fully Insulated	100	504.821
	.110x.032	–		314.001	–	–	–	–			
22 – 16AWG Red 0.34 – 1.5mm ²	.110x.020	304.010		314.010	314.110	324.010	324.110	–	Dimpled Fully Insulated	100	Non-insulated 504.842 504.931 504.942
	.110x.032	304.011		314.011	314.111	324.011	324.111	–			
	.187x.020	304.012		314.012	314.112	324.012	324.112	–			
	.187x.032	304.013		314.013	314.113	324.013	324.113	–			
	.205x.020	–		314.014	–	324.014	–	–			
	.250x.032	304.015		314.015	314.115	324.015	324.115	324.215			
	.312x.032	–		314.016	–	–	–	–			
16 – 14AWG Blue 1.5 – 2.5mm ²	.110x.020	–		314.020	314.120	324.020	–	Insulated	100	Insulated 500.821 500.064 504.822 504.921	
	.110x.032	–		314.021	314.121	324.021	–				
	.187x.020	304.022		314.022	314.122	324.022	324.122				–
	.187x.032	304.023		314.023	314.123	324.023	324.123				–
	.205x.020	–		314.024	–	–	–				–
	.250x.032	304.025		314.025	314.125	324.025	324.125				324.225
	.312x.032	–		314.026	–	324.026	–				–
12 – 10AWG Yellow 4 – 6mm ²	.375x.047	–		314.027	–	–	–	–	50		
	.187x.020	–		314.032	–	–	–	–			
	.250x.032	304.035		314.035	314.135	324.035	324.135	324.235			
	.375x.047	–		314.037	–	324.037	–	–			

Information subject to change without notice

Male Disconnects (Tabs) (Order by Part No.)

Range AWG Colour mm ²	Tab Size (inches)	Part Numbers						Pack	Tool
		Non-Insulated (butted seam)		Vinyl Insulated (rounded)	Nylon Insulated	Nylon Fully Insulated (rounded)	Nylon Fully Insulated (dimpled)		
22 – 16AWG Red 0.34 – 1.5mm ²	.110x.020	–		315.010	325.010	–	–	100	Non-insulated 504.842 504.931 504.942
	.11 x.032	–		315.011	325.011	–	–		
	.187x.020	–		315.012	325.012	–	–		
	.187x.032	305.013		315.013	325.013	–	–		
	.250x.032	305.015		315.015	325.015	325.115	325.215		
16 – 14AWG Blue 1.5 – 2.5mm ²	.187x.020	–		315.022	325.022	–	–	100	Insulated 500.064 504.921
	.187x.032	–		315.023	325.023	–	–		
	.250x.032	305.025		315.025	325.025	325.125	325.225		
12 – 10AWG Yellow 4 – 6mm ²	.250x.032	305.035		315.035	325.035	325.135	325.235	50	rounded
									dimpled

Information subject to change without notice

Flag Disconnects (Order by Part No.)

Range AWG Colour mm ²	Tab Size (inches)	Part Number				Pack	Tool
		Non-Insulated		Nylon Fully Insulated			
22 – 16AWG Red 0.34 – 1.5mm ²	.187 x .020	–		324.712		100	Non-insulated 501.334 504.335
	.187 x .032	–		324.713			
.250 x .032	304.715	324.715					
16 – 14AWG Blue 1.5 – 2.5mm ²	.187 x .020	–		324.722		100	
	.187 x .032	304.723		324.723			
12 – 10AWG 4 – 6mm ²	.250 x .032	304.725		324.725		50	
		304.735	324.735				

Information subject to change without notice

Piggyback Disconnects (Order by Part No.)

Range AWG Colour mm ²	Tab Size (inches)	Part Number				Pack	Tool
		Vinyl Insulated		Nylon Fully Insulated			
22 – 16AWG Red 0.34 – 1.5mm ²	.250 x .032	314.615		324.515		100	Insulated 500.064 504.921
				314.625		324.525	
314.635	–	50					



Information subject to change without notice

Closed End Crimp Connectors (Order by Part No.)

Range AWG mm ²	Part Number				Pack	Tool
	Nylon Insulated - Round Top		Nylon Insulated - Flat Top			
22 – 16AWG 0.34 – 1.5mm ²	326.810		326.811		100	500.825 504.925
16 – 14AWG 1.5 – 2.5mm ²	326.820		326.821		100	
12 – 10AWG 4 – 6mm ²	326.830		326.831		100	
8AWG 10mm ²	326.840		326.841		50	–



Information subject to change without notice

Female Bullet Connectors (Order by Part No.)

Range AWG Colour mm ²	Bullet Diam.	Part Number				Pack	Tool
		Vinyl Fully Insulated		Nylon Fully Insulated			
22 – 16AWG Red 0.34 – 1.5mm ²	.156"	314.911		324.911		100	Insulated 500.064 504.921
16 – 14AWG Blue 1.5 – 2.5mm ²	.156"	314.921		324.921		100	
	.195"	314.922		324.922			
12 – 10AWG Yellow 4 – 6mm ²	.195"	314.932		–		50	







Information subject to change without notice

Male Bullet Connectors (Order by Part No.)

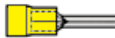
Range AWG Colour mm ²	Bullet Diam.	Part Number				Pack	Tool
		Vinyl Insulated		Nylon Fully Insulated			
22 – 16AWG Red 0.34 – 1.5mm ²	.156"	315.811		325.911		100	Insulated 500.064 504.921
16 – 14AWG Blue 1.5 – 2.5mm ²	.156"	315.821		325.921		100	
	.195"	315.822		–			
12 – 10AWG Yellow 4 – 6mm ²	.195"	315.832		–		50	

Information subject to change without notice

Pin Terminals (Order by Part No.)

Range AWG Colour mm ²	Pin Length	Part Number				Pack	Tool	
		Non- Insulated (brazed seam)		Vinyl Insulated				
26 – 22AWG yellow 0.14 – 0.34mm ²	10mm	–	–	323.600 (nylon ins.)		100	Non-insulated 504.842 504.931 504.931	
22 – 16AWG Red 0.34 – 1.5mm ²	10mm	303.610		313.610		100		
	12mm	303.612		313.612				100
	16mm	303.615		313.615				
16 – 14AWG Blue 1.5 – 2.5mm ²	10mm	303.620		313.620		100		
	12mm	303.622		313.622				
	16mm	303.625		313.625				
12 – 10AWG Yellow 4 – 6mm ²	14mm	303.634		313.632		50	Insulated 500.064 504.921	

Information subject to change without notice

Blade & Lipped Blade Terminals (Order by Part No.)

Range AWG Colour mm ²	Blade Length (mm)	Part Number							P a c k	Tool
		Non-Insulated Blade (butted seam)		Non-Insulated Lipped Blade (butted seam)		Vinyl Insulated Blade		Vinyl Insulated Lipped Blade		
22 – 16AWG Red 0.34 – 1.5mm ²	13x3.1	303.014		–		–		–	100	Non- insulated 504.842 504.931 504.942 Insulated 500.064 504.921
	13x3.25	–		–		313.014		–		
	17x4.6	–		–		–		313.111		
	17x2.3	303.015		303.111		–		–		
	17x2.6	–		–		313.015		–		
17.4x3	–		–		–		311.112			
16 – 14AWG Blue 1.5 – 2.5mm ²	14x2.5	303.024		–		–		–	100	
	14x3.2	–		–		313.024		–		
	17x2.1	303.025		–		–		–		
	17x2.6	–		–		313.025		–		
12 – 10AWG Yellow 4 – 6mm ²	17x4.75	–		–		–		313.121	50	
	13x4.1	303.034		–		313.034		–		
	17.2x3	–		–		–		313.132		
	17x4.5	–		–		–		–		
	17x4.7	–		–		–		313.131		

Information subject to change without notice

Quick Splice w/ Disconnect (Order by Part No.)

Range AWG Colour mm ²	Polypropylene Insulated Quick Splice with Female Disconnect		Polypropylene Insulated Quick Splice with Bullet Receptacle		Pack
22 – 16 Red/Maroon 0.34 – 1.5 mm ²	316.111 (type A)		–		100
	326.615				
16 – 14 Blue 1.5 – 2.5 mm ²	326.625		316.725 (black)		100
12 – 10 Yellow 4 – 6 mm ²	326.635		–		50

Information subject to change without notice

Terminals on Tape (in spools)

ITC offers a variety of solderless crimp terminals mounted on mylar tape in spools of 500 or 1000 pieces (depending on terminal size and style) for use on most common high-volume crimping machines.

Many Vinyl Insulated Rings, Spades and Female Disconnects on tape are available from stock, and with lead time, ITC can provide taped versions of most of the non-insulated, vinyl insulated or nylon insulated terminals found in our catalogue. See directions below for part numbers.

Terminals on tape: Find the loose piece part number in our catalogue and change the second digit to:		
Non-Insulated Terminals	Vinyl Insulated Terminals	Nylon Insulated Terminals
Change the Second Digit in part number from '0' to '8'	Change the Second Digit in part number from '1' to '6'	Change the Second Digit in part number from '2' to '7'

Heat Shrink Butt Splices

These splicing terminals have an internal copper tube with a wire stop in the middle, insulated by a tube of high-density heat-shrinkable polyethylene (PE), colour coded for identification. There are four models for wires ranging from 22AWG to 8AWG. This family of butt splices also include four 'step-down' models, used to connect wires of different sections on each side of the terminal.



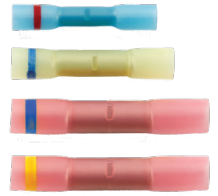

A coloured ring stamped on one side indicates the different wire section.



Features and specifications



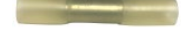

- **Insulation:** high-density heat-shrinkable polyethylene (PE)
- **Rated maximum voltage:** 600V
- **Rated maximum current:** dependent on wire used, from 9A (22AWG) to 70A (8AWG)
- **Operating temperature:** -40 to 105 °C
- **Shrink temperature:** 150 °C
- **Shrink ratio:** approximately 2.5:1
- **Approvals:** cULus (#E96029)

Heat Shrink Butt Splices (Order by Part No.)

Range	Part No.	Description		Pack
22-16AWG	346.310	Heat shrink PE butt splice, red		100
16-14AWG	346.320	Heat shrink PE butt splice, blue		100
12-10AWG	346.350	Heat shrink PE butt splice, yellow		50
8AWG	346.380	Heat shrink PE butt splice, red		50

Information subject to change without notice

Heat Shrink 'Step-Down' Butt Splices (Order by Part No.)

Range	Part No.	Description		Pack
16-14 to 22-16AWG	346.321	Heat shrink Change-down PE butt splice, blue w/red ring		100
12-10 to 16-14AWG	346.352	Heat shrink Change-down PE butt splice, yellow w/blue ring		100
8 to 16-14AWG	346.382	Heat shrink Change-down PE butt splice, red w/blue ring		50
8 to 12-10AWG	346.385	Heat shrink Step-down PE butt splice, red w/yellow ring		50

Information subject to change without notice

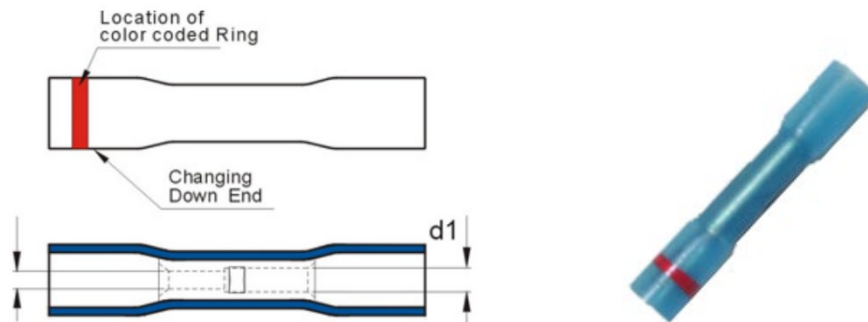

For information on our cordless heat gun for heat shrink terminals consult our online catalog EC-2419 Heat Shrink Butt Splices and Cordless Heat Gun, or contact ITC.



High Temperature Solderless Crimp Terminals







ITC's High Temperature non-insulated Solderless Crimp Terminals are made of nickel-plated steel, (with copper sleeve for disconnect types), appropriate for special applications where high temperatures are expected.

Temperature ratings (maximum):

- Ring, Spade terminals: 480°C (900°F)
- Male / Female Disconnects: 380°C (650°F)

Materials: nickel-plated steel (with copper sleeve for disconnect types)

High Temperature Crimp Terminals (Order by Part No.)

Range AWG mm ² Stud/Tab	Part No.	Description		L mm	W mm	Barrel		P a c k	Tool
						O.D.	I.D.		
22 – 18 0.34 – 0.75 # 10	301.815	Non-insulated HT ring terminal		15.6	8	3.4	1.7	100	500.842 504.942 504.931
16 – 14 1.5 – 2.5 # 10	301.825	Non-insulated HT ring terminal		16	8	4.2	2.3	100	
12 – 10 4.0 – 6.0 # 10	301.835	Non-Insulated HT ring terminal		19.5	9.5	5.6	3.4	50	
22 – 18 0.34 – 0.75 # 10	302.815	Non-Insulated HT spade terminal		18.5	7.9	3.4	1.7	100	
16 – 14 105 – 2.5 # 10	302.825	Non-Insulated HT spade terminal		18.5	8.7	4.2	2.3	100	
12 – 10 4.0 – 6.0 # 10	302.835	Non-Insulated HT spade terminal		18.3	9.4	5.6	3.4	50	
22 – 16 0.34 – 1.5 .25"x.032"	304.815	Non-Insulated HT fem. Disconnect		15.5	6.9	3.4	1.7	100	
16 – 14 1.5 – 2.5 .25"x.032"	304.825	Non-Insulated HT fem. Disconnect		15.5	6.9	4.2	2.3	100	
12 – 10 4.0 – 6.0 .25"x.032"	304.835	Non-Insulated HT fem. Disconnect		17	6.9	5.6	3.4	50	
22 – 16 0.34 – 1.5 .25"x.032"	305.815	Non-Insulated HT male disconnect		15.5	6.4	3.4	1.7	100	
16 – 14 1.5 – 2.5 .25"x.032"	305.825	Non-Insulated HT male disconnect		15.5	6.4	3.4	1.7	100	
12 – 10 4.0 – 6.0 .25"x.032"	305.835	Non-Insulated HT male disconnect		17	6.4	5.6	3.4	50	
22 – 18 0.34 – 0.75	306.810	Non-Insulated HT butt splice		15	–	3.3	1.7	100	
16 – 14 1.5 – 2.5	306.820	Non-Insulated HT butt splice		15	–	4.1	2.3	100	
12 – 10 4.0 – 6.0	306.830	Non-Insulated HT butt splice		15	–	5.4	3.4	50	

Information subject to change without notice

Solderless Crimp Terminal Kits

ITC's most common vinyl-insulated crimp terminals are now also supplied in a sturdy and practical metal case, with an optional crimping tool. Convenient for any electrical shop, and a great solution for use on a truck or van. Case dimensions: 345x260x45mm (1x2x2.4")







Solderless Crimp Terminal Kits (Order by Part No.)

Range AWG / mm ²	Part No.	Content	Contents Qty	Tool
22 – 10AWG 0.50 – 6.0mm ²	199.141K	20 types of ring, spade, disconnect insulated crimp terminals, butt splices and closed-end connectors; 22-10AWG	500 pieces	–
	199.142K		500 pieces	500.821 504.921*

* alternate tool; Information subject to change without notice

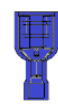
Kit contents

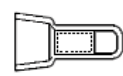
Range AWG mm ²	Stud Size	Part No.	Description		Qty
22 – 16AWG 0.5 – 1.5mm ²	4.3mm, #8	311.014	Insulated ring terminal		25
	5.3mm, #10	311.015	Insulated ring terminal		25
16 – 14AWG 1.5 – 2.5mm ²	10.4mm, 3/8"	311.028	Insulated ring terminal		25
12 – 10AWG 4.0 – 6.0mm ²	4.3mm, #8	311.034	Insulated ring terminal		25
16 – 14AWG 1.5 – 2.5mm ²	3.7mm, #6	311.023	Insulated ring terminal		25
12 – 10AWG 4.0 – 6.0mm ²	5.3mm, #10	311.035	Insulated ring terminal		25
16 – 14AWG 1.5 – 2.5mm ²	4.3mm, #8	311.024	Insulated ring terminal		25
12 – 10AWG 4.0 – 6.0mm ²	10.4mm, 3/8"	311.038	Insulated ring terminal		25
16 – 14AWG 1.5 – 2.5mm ²	5.3mm, #10	311.025	Insulated ring terminal		25
22 – 16AWG 0.5 – 1.5mm ²	5.3mm, #10	312.015	Insulated spade terminal		
16 – 14AWG 1.5 – 2.5mm ²	5.3mm, #10	312.025	Insulated spade terminal	25	
12 – 10AWG 4.0 – 6.0mm ²	5.3mm, #10	312.035	Insulated spade terminal	25	
Range	Tab Size	Part No.	Description		Qty
22 – 16AWG 0.5 – 1.5mm ²	.250x.032"	314.015	Insulated female disconnect		25
16 – 14AWG 1.5 – 2.5mm ²	.250x.032"	314.025	Insulated female disconnect		25
12 – 10AWG 4.0 – 6.0mm ²	.250x.032"	314.035	Insulated female disconnect		25
Range		Part No.	Description		Qty
22 – 16AWG 0.5 – 1.5mm ²	–	316.310	Insulated butt splice		25
16 – 14AWG 1.5 – 2.5mm ²	–	316.320	Insulated butt splice		25
12 – 10AWG 4.0 – 6.0mm ²	–	316.330	Insulated butt splice		25
16 – 14AWG 1.5 – 2.5mm ²	–	326.820	Close end crimp connector, round tip		25
12 – 10AWG 4.0 – 6.0mm ²	–	326.830	Close end crimp connector, round tip		25
–	–	500.821*	Crimping Tool - Series 800 for insulated crimp terminals 22-10AWG		1

* for 199.142K kit only. Information subject to change without notice

Solderless Crimp Terminal Slide-Box Kits

ITC's Solderless Crimp Terminals are also available in handy, attractive packages - convenient for display and for usage in electrical shops of any size.

The plastic slide-box box is fully reusable.

Features and specifications:

- Box made of impact-resistant thermoplastic resin, designed to hang on standard display hooks. Covers are in transparent plastic, to show contents of each compartment
- Covers slide easily with thumb action, yet single compartments are safely closed until needed
- Available in prepared kits or as required - consult ITC
- The empty slide-box is also available in eight different colours - see page 26

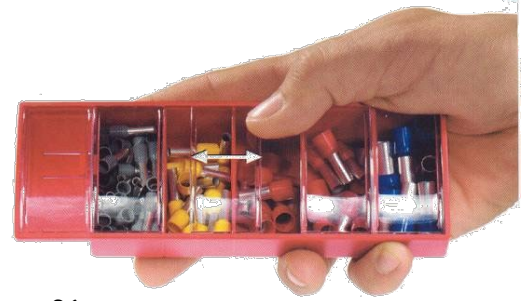

Solderless Crimp Terminal Slide-Box Kits (Order by Part. No.)

Range AWG mm ²	Part No.	Description	Compartment 1	Compartment 2	Compartment 3	Compartment 4	Compartment 5
22 – 16 0.5 – 1.5	790.120	RED Crimp terminal assortment kit	50 non insulated ring terminals, #8 stud, 301.014	50 insulated ring terminals, #8 stud, 311.014	50 insulated spade terminal, #8 stud, 312.014	25 insulated butt splices, 22-16AWG, 316.310	25 fully insulated female disconnects, ¼" tab, 314.115
16 – 14 1.5 – 2.5	790.121	BLUE Crimp terminal assortment kit	50 non insulated ring terminals, #10 stud, 301.025	40 insulated ring terminals, #10 stud, 311.025	40 insulated spade term #10 stud, 312.025	20 insulated butt splices, 16-14AWG, 316.320	20 fully insulated female disconnects, ¼" tab, 314.125
12 – 10 4.0 – 6.0	790.122	YELLOW Crimp terminal assortment kit	40 non insulated ring terminals, #10 stud, 301.035	20 insulated ring terminals, #10 stud, 311.035	20 insulated spade term #10 stud, 312.035	15 insulated butt splices, 12-10AWG, 316.330	15 fully insulated female disconnects, ¼" tab, 314.135

Information subject to change without notice



Colour-Coded Power Lugs Standard Length '39C'

39C series power lugs are manufactured from heavy-duty electrolytic copper, and annealed to obtain optimum mechanical performances - a must in order to withstand the severe stress during compression, as well as the possible bending of the palm during installation. The dimensions of the tube are designed to obtain the most efficient combination of electrical conductivity and mechanical strength, to resist vibration and pull-out effort.

Lugs are tin plated to prevent corrosion. The tongue is clearly marked with wire size, and an inspection hole facilitates full insertion of the conductor.

Material: Annealed heavy-duty electrolytic copper; tin plated

Approvals: cULus (UL486A up to 35KV) **Standards:** EN 61238-1; CE 2006/95/CE

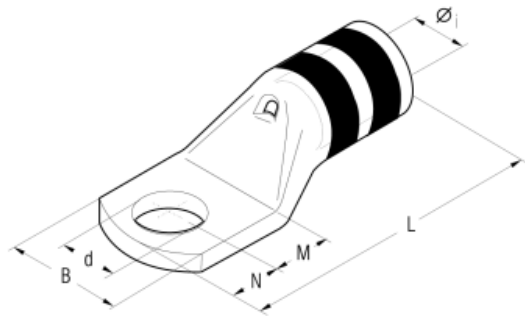

Colour-Coded Power Lugs Standard Length (Order by Part No.)

Range AWG mm ²	Stud Size	Part No.	Dimensions (inches)						Tool 502.551K (H-240R)	Tool 502.771K (H-4113)
			Φ	B	M	N	L	d	Die	Die
8AWG 10mm ²	#8	39C8-8	.18	.39	.20	.16	.89	.17	1016	-
	#10	39C8-10	.18	.39	.26	.24	1.02	.21		
	¼"	39C8-14	.18	.43	.28	.24	1.04	.25		
	5/16"	39C8-516	.18	.59	.35	.31	1.20	.33		
	3/8"	39C8-38	.18	.71	.43	.39	1.36	.41		
6AWG 16mm ²	½"	39C8-12	.18	.75	.55	.47	1.56	.52		16
	#8	39C6-8	.24	.49	.20	.16	1.00	.17		
	#10	39C6-10	.24	.49	.26	.24	1.14	.21		
	¼"	39C6-14	.24	.49	.28	.24	1.16	.25		
	5/16"	39C6-516	.24	.59	.35	.31	1.32	.33		
4AWG 25mm ²	3/8"	39C6-38	.24	.71	.43	.39	1.48	.41	25	
	½"	39C6-12	.24	.79	.55	.47	1.67	.52		
	#8	39C4-8	.24	.49	.20	.16	1.00	.17		
	#10	39C4-10	.24	.49	.26	.24	1.14	.21		
	¼"	39C4-14	.24	.49	.28	.24	1.16	.25		
3AWG 27mm ²	5/16"	39C4-516	.24	.59	.35	.31	1.32	.33	2535	
	3/8"	39C4-38	.24	.71	.43	.39	1.48	.41		
	½"	39C4-12	.24	.79	.55	.47	1.67	.52		
	#8	39C3-8	.28	.55	.20	.16	1.10	.17		
	#10	39C3-10	.28	.55	.26	.24	1.24	.21		
2AWG 35mm ²	¼"	39C3-14	.28	.55	.28	.24	1.26	.25	35	
	5/16"	39C3-516	.28	.55	.35	.31	1.42	.33		
	3/8"	39C3-38	.28	.59	.43	.39	1.57	.41		
	½"	39C3-12	.28	.71	.55	.47	1.77	.52		
	#10	39C2-10	.30	.83	.26	.24	1.30	.21		
1AWG 50mm ²	¼"	39C2-14	.30	.67	.28	.24	1.32	.25	5070	
	5/16"	39C2-516	.30	.67	.35	.31	1.48	.33		
	3/8"	39C2-38	.30	.67	.43	.39	1.63	.41		
	½"	39C2-12	.30	.83	.55	.47	1.83	.52		
	¼"	39C1-14	.35	.67	.28	.24	1.36	.25		
50mm ²	5/16"	39C1-516	.35	.67	.35	.31	1.52	.33	50	
	3/8"	39C1-38	.35	.75	.43	.39	1.67	.41		
	½"	39C1-12	.35	.83	.55	.47	1.87	.52		

Continued on next page

*Color-coded crimp terminals are only marked for use with class B and C cable



Colour-Coded Power Lugs Standard Length (Order by Part No.)

Range AWG mm ²	Stud Size	Part No.	Dimensions (inches)						Tool 502.551K (H-240R)	Tool 502.771K (H-4113)	
			Φ	B	M	N	L	d	Die	Die	
1/0AWG 55mm ²	¼"	39C1/0-14	.39	.75	.31	.28	1.59	.25	5070	50	
	5/16"	39C1/0-516	.39	.75	.35	.31	1.67	.33			
	3/8"	39C1/0-38	.39	.79	.43	.39	1.83	.41			
	½"	39C1/0-12	.39	.83	.55	.47	2.03	.52			
	9/16"	39C1/0-916	.39	.98	.63	.55	2.19	.59			
2/0AWG 70mm ²	5/8"	39C1/0-58	.39	1.02	.71	.63	2.34	.67		95120	70
	¼"	39C2/0-14	.44	.83	.31	.28	1.73	.25			
	5/16"	39C2/0-516	.44	.83	.35	.31	1.81	.33			
	3/8"	39C2/0-38	.44	.83	.43	.39	1.97	.41			
	½"	39C2/0-12	.44	.87	.55	.47	2.17	.52			
3/0AWG 95mm ²	9/16"	39C2/0-916	.44	.98	.63	.55	2.32	.59	95120		95
	5/8"	39C2/0-58	.44	1.02	.71	.63	2.48	.67			
	¾"	39C2/0-34	.44	1.16	.87	.79	2.95	.83			
	¼"	39C3/0-14	.49	.91	.31	.28	1.81	.25			
	5/16"	39C3/0-516	.49	.91	.35	.31	1.89	.33			
4/0AWG 120mm ²	3/8"	39C3/0-38	.49	.91	.43	.39	2.05	.41		95120	120
	½"	39C3/0-12	.49	.94	.55	.47	2.24	.52			
	9/16"	39C3/0-916	.49	1.06	.63	.55	2.40	.59			
	5/8"	39C3/0-58	.49	1.10	.71	.63	2.56	.67			
	¾"	39C3/0-34	.49	1.24	.87	.79	2.87	.83			
250 MCM 127mm ²	¼"	39C4/0-14	.53	.98	.31	.28	1.99	.25	95120		120
	5/16"	39C4/0-516	.53	.98	.35	.31	2.07	.33			
	3/8"	39C4/0-38	.53	.98	.43	.39	2.22	.41			
	½"	39C4/0-12	.53	.98	.55	.47	2.42	.52			
	9/16"	39C4/0-916	.53	.98	.63	.55	2.58	.59			
300 MCM 150mm ²	5/8"	39C4/0-58	.53	1.06	.71	.63	2.74	.67		150	150
	¾"	39C4/0-34	.53	1.16	.87	.79	3.05	.83			
	¼"	39C250-14	.60	1.12	.31	.28	2.05	.25			
	5/16"	39C250-516	.60	1.12	.35	.31	2.13	.33			
	3/8"	39C250-38	.60	1.12	.43	.39	2.28	.41			
350 MCM 185mm ²	½"	39C250-12	.60	1.12	.55	.47	2.48	.52	185		185
	9/16"	39C250-916	.60	1.12	.63	.55	2.64	.59			
	5/8"	39C250-58	.60	1.12	.71	.63	2.80	.67			
	¾"	39C250-34	.60	1.18	.87	.79	3.11	.83			
	7/8"	39C250-78	.60	1.26	.94	.87	3.27	.91			
400 MCM 203mm ²	5/16"	39C300-516	.66	1.24	.51	.43	2.72	.33		185	185
	3/8"	39C300-38	.66	1.24	.51	.43	2.72	.41			
	½"	39C300-12	.66	1.24	.63	.55	2.95	.52			
	9/16"	39C300-916	.66	1.24	.71	.63	3.11	.59			
	5/8"	39C300-58	.66	1.24	.75	.67	3.19	.67			
500 MCM 240mm ²	¾"	39C300-34	.66	1.24	.87	.79	3.43	.83	240		240
	7/8"	39C300-78	.66	1.24	.94	.91	3.62	.91			
	3/8"	39C350-38	.69	1.30	.51	.43	2.78	.41			
	½"	39C350-12	.69	1.30	.63	.55	3.01	.52			
	9/16"	39C350-916	.69	1.30	.71	.63	3.17	.59			
600 MCM 300mm ²	5/8"	39C350-58	.69	1.30	.75	.67	3.25	.67		240	240
	¾"	39C350-34	.69	1.30	.87	.79	3.48	.83			
	7/8"	39C350-78	.69	1.46	.94	.91	3.68	.91			
	3/8"	39C400-38	.76	1.40	.51	.43	2.99	.41			
	½"	39C400-12	.76	1.40	.63	.55	3.23	.52			
750 MCM 400mm ²	9/16"	39C400-916	.76	1.40	.71	.63	3.39	.59	240		240
	5/8"	39C400-58	.76	1.40	.75	.67	3.46	.67			
	¾"	39C400-34	.76	1.40	.87	.79	3.70	.83			
	7/8"	39C400-78	.76	1.40	.94	.91	3.90	.91			
	3/8"	39C500-38	.83	1.54	.51	.43	3.23	.41			
300mm ²	½"	39C500-12	.83	1.54	.63	.55	3.46	.52		300	300
	9/16"	39C500-916	.83	1.54	.71	.63	3.62	.59			
	5/8"	39C500-58	.83	1.54	.75	.67	3.70	.67			
	¾"	39C500-34	.83	1.54	.87	.79	3.94	.83			
	7/8"	39C500-78	.83	1.54	.94	.91	4.13	.91			
400mm ²	½"	39C600-12	.93	1.73	.63	.55	3.90	.52	400		400
	9/16"	39C600-916	.93	1.73	.71	.63	4.06	.59			
	5/8"	39C600-58	.93	1.73	.75	.67	4.17	.67			
	¾"	39C600-34	.93	1.73	.87	.79	4.41	.83			
	7/8"	39C600-78	.93	1.73	.94	.91	4.41	.91			
400mm ²	½"	39C750-12	1.02	2.56	.87	.75	4.45	.52		400	400
	5/8"	39C750-58	1.02	2.56	.87	.75	4.45	.67			
	¾"	39C750-34	1.02	2.56	.87	.75	4.45	.83			
			7/8"	39C750-78	1.02	2.56	.94	.91		4.69	.91

Information subject to change without notice; Dies shown above are metric sized.

*Color-coded crimp terminals are only marked for use with class B and C cable

Colour-Coded Power Lugs ‘39CL’ (One Hole-Long Barrel)

39CL series long-barrel power lugs are designed with an extra-long barrel, which provides extra pull-out strength. Lugs are tin plated to prevent corrosion. The tongue is clearly marked with wire size.

Material: Annealed heavy-duty electrolytic copper; tin plated
Approvals: cULus (UL486A up to 35KV)
Standards: EN 61238-1; CE 2006/95/CE



Colour-Coded Long Barrel Power Lugs (Order by Part No.)

Range AWG mm ²	Stud Size	Part No.	Dimensions (inches)						Tool 502.551K (H-240R)	Tool 502.771K (H-4113)
			Φ	B	M	N	L	d	Die	Die
8AWG 10mm ²	#10	39CL8-10	.18	.39	.25	.23	1.47	.20	1016	—
	¼"	39CL8-14	.18	.43	.27	.23	1.49	.25		
	3/8"	39CL8-38	.18	.70	.43	.39	1.81	.41		
6AWG 16mm ²	#10	39CL6-10	.22	.45	.25	.23	1.57	.20	16	16
	¼"	39CL6-14	.22	.45	.27	.23	1.59	.25		
	½"	39CL6-12	.22	.78	.55	.47	2.10	.51		
4AWG 25mm ²	#10	39CL4-10	.24	.49	.25	.23	1.85	.20	2535	25
	¼"	39CL4-14	.24	.49	.27	.23	1.87	.25		
	3/8"	39CL4-38	.24	.70	.43	.39	2.18	.41		
3AWG 27mm ²	½"	39CL4-12	.24	.78	.55	.47	2.38	.51	2535	25
	¼"	39CL3-14	.27	.55	.27	.23	1.87	.25		
	5/16"	39CL3-516	.27	.59	.35	.31	2.02	.33		
2AWG 35mm ²	3/8"	39CL3-38	.27	.70	.43	.39	2.18	.41	2535	25
	½"	39CL3-12	.27	.82	.55	.47	2.38	.51		
	¼"	39CL2-10	.29	.66	.25	.23	1.81	.20		
1AWG 50mm ²	5/16"	39CL2-516	.29	.66	.35	.31	1.98	.33	5070	35
	¼"	39CL2-14	.29	.66	.27	.23	1.83	.25		
	5/16"	39CL2-516	.29	.66	.35	.31	1.98	.33		
1/0AWG 55mm ²	½"	39CL2-12	.29	.82	.55	.47	2.34	.51	5070	35
	10	39CL1-10	.35	.66	.35	.31	1.88	.20		
	5/16"	39CL1-516	.35	.66	.35	.31	2.06	.33		
2/0AWG 70mm ²	½"	39CL1-12	.35	.82	.55	.47	2.42	.51	5070	50
	10	39CL1/0-10	.39	.74	.31	.27	2.10	.20		
	5/16"	39CL1/0-516	.39	.74	.35	.31	2.18	.33		
3/0AWG 95mm ²	3/8"	39CL1/0-38	.39	.78	.43	.39	2.34	.41	5070	50
	½"	39CL1/0-12	.39	.82	.55	.47	2.53	.51		
	3/8"	39CL2/0-38	.44	.82	.43	.39	2.65	.41		
4/0AWG 120mm ²	½"	39CL2/0-12	.44	.86	.55	.47	2.85	.51	95120	120
	½"	39CL3/0-12	.48	.94	.55	.47	2.81	.51		
	3/8"	39CL4/0-38	.53	.98	.43	.39	2.89	.41		
250 MCM 127mm ²	½"	39CL4/0-12	.53	.98	.55	.47	3.09	.51	95120	120
	½"	39CL250-12	.59	1.12	.55	.47	3.30	.51		
300 MCM 150mm ²	½"	39CL300-12	.65	1.24	.62	.55	3.85	.51	150	150
350MCM 185mm ²	½"	39CL350-12	.69	1.29	.62	.55	3.85	.51	185	185
	½"	39CL400-12	.75	1.39	.62	.55	4.21	.51		
400 MCM 203mm ²	5/8"	39CL400-58	.75	1.39	.74	.66	4.44	.66	240	240
	½"	39CL500-12	.83	1.53	.62	.55	4.25	.51		
500 MCM 240mm ²	5/8"	39CL500-58	.83	1.53	.74	.66	4.48	.66	240	240
	½"	39CL600-12	.93	1.73	.78	.55	5.05	.51		
600 MCM 300mm ²	5/8"	39CL600-58	.93	1.73	.86	.74	5.33	.66	—	300
	½"	39CL750-12	1.02	1.88	.86	.74	5.53	.51		
750 MCM 400mm ²	5/8"	39CL750-58	1.02	1.88	.86	.74	5.53	.66	—	400

Information subject to change without notice; Dies shown above are metric sized.

*Color-coded crimp terminals are only marked for use with class B and C cable



Colour-Coded Long Barrel Power Lugs “39CL-D” (2-Holes)

39CL-D series power lugs’ long barrels provide superior mechanical pull-out resistance.

Lugs are tin plated to prevent corrosion. The tongue is clearly marked with wire size.

Material: Annealed heavy-duty electrolytic copper; tin plated

Approvals: cULus (UL486A up to 35KV) Standards: EN 61238-1; CE 2006/95/CE



Colour-Coded Long Barrel 2-hole Power Lugs (Order by Part No.)

Range AWG mm ²	Stud Size	Part No.	Dimensions (inches)							Tool 502.551K (H-240R) Die	Tool 502.771K (H-4113) Die			
			Φ	B	M	E	N	L	d					
8AWG 10mm ²	¼"	39CL8-D14	.18	.43	.28	5/8"	.24	2.09	.25	1016	-			
	¼"	39CL8-D141	.18	.43	.28	3/4"	.24	2.20	.25					
	¾"	39CL8-D38	.18	.71	.43	1"	.39	2.78	.41					
6AWG 16mm ²	¼"	39CL6-D14	.23	.45	.26	5/8"	.24	2.15	.25		1016	16		
	¼"	39CL6-D141	.23	.45	.26	3/4"	.24	2.26	.25					
	¾"	39CL6-D38	.23	.71	.43	1"	.39	2.63	.41					
4AWG 25mm ²	½"	39CL6-DN	.23	.79	.55	1 ¾"	.47	3.76	.52			2535	25	
	¼"	39CL4-D14	.24	.49	.28	5/8"	.24	2.44	.25					
	¼"	39CL4-D141	.24	.49	.28	3/4"	.24	2.55	.25					
3AWG 27mm ²	¾"	39CL4-D38	.24	.71	.43	1"	.39	3.13	.41				2535	25
	½"	39CL4-DN	.24	.79	.55	1 ¾"	.47	4.07	.52					
	¾"	39CL3-D38	.28	.71	.43	1"	.39	3.13	.41					
2AWG 35mm ²	½"	39CL3-DN	.28	.83	.55	1 ¾"	.47	4.07	.52	2535				35
	¼"	39CL2-D14	.30	.67	.28	5/8"	.24	2.40	.25					
	¼"	39CL2-D141	.30	.67	.28	3/4"	.24	2.52	.25					
1AWG 50mm ²	¾"	39CL2-D38	.30	.75	.43	1"	.39	3.09	.41		5070			35
	¾"	39CL2-DN38	.30	.75	.43	1 ¾"	.39	3.64	.41					
	½"	39CL2-DN	.30	.83	.55	1 ¾"	.47	4.04	.52					
1/0AWG 55mm ²	¼"	39CL1-D14	.35	.67	.28	5/8"	.24	2.48	.25			5070		50
	¼"	39CL1-D141	.35	.67	.28	3/4"	.24	2.60	.25					
	¾"	39CL1-D38	.35	.75	.43	1"	.39	3.17	.41					
2/0AWG 70mm ²	½"	39CL1-DN	.35	.83	.55	1 ¾"	.47	4.11	.52				5070	50
	¼"	39CL1/0-D14	.39	.75	.31	5/8"	.28	2.68	.25					
	¼"	39CL1/0-D141	.39	.75	.31	3/4"	.28	2.80	.25					
3/0AWG 95mm ²	¾"	39CL1/0-D38	.39	.75	.43	1"	.39	3.29	.41	95120				70
	½"	39CL1/0-DN	.39	.83	.55	1 ¾"	.47	4.23	.52					
	¼"	39CL2/0-D14	.44	.83	.31	5/8"	.28	2.99	.25					
4/0AWG 120mm ²	¼"	39CL2/0-	.44	.83	.31	3/4"	.28	3.11	.33		95120			70
	¾"	39CL2/0-D38	.44	.83	.43	1"	.39	3.60	.41					
	½"	39CL2/0-DN	.44	.87	.55	1 ¾"	.47	4.55	.52					
250 MCM 127mm ²	¼"	39CL3/0-D141	.49	.91	.31	3/4"	.28	3.23	.25			95120		95
	¾"	39CL3/0-D38	.49	.91	.43	1"	.39	3.72	.41					
	½"	39CL3/0-DN	.49	.94	.55	1 ¾"	.47	4.67	.52					
300 MCM 150mm ²	¼"	39CL4/0-D14	.53	.98	.51	5/8"	.43	3.70	.25				95120	120
	¾"	39CL4/0-6D38	.53	.98	.43	3/4"	.39	3.84	.41					
	¾"	39CL4/0-DN38	.53	.98	.43	1"	.39	4.59	.41					
350 MCM 185mm ²	½"	39CL4/0-DN	.53	.98	.55	1 ¾"	.47	4.78	.52	150				120
	¾"	39CL250-D38	.60	1.12	.43	1"	.39	4.06	.41					
	½"	39CL250-DN	.60	1.12	.55	1 ¾"	.47	5.00	.52					
400 MCM 200mm ²	¾"	39CL300-D38	.66	1.24	.51	1"	.43	4.57	.41		150			150
	½"	39CL300-DN	.66	1.24	.55	1 ¾"	.47	5.55	.52					
	¼"	39CL350-D141	.69	1.30	.51	3/4"	.43	4.31	.25					
500 MCM 240mm ²	¾"	39CL350-D38	.69	1.30	.51	1"	.43	4.57	.41			185		185
	½"	39CL350-DN	.69	1.30	.55	1 ¾"	.47	5.55	.52					
	¼"	39CL400-D141	.76	1.40	.51	3/4"	.43	4.67	.41					
600 MCM 300mm ²	¾"	39CL400-D38	.76	1.40	.51	1"	.43	4.92	.67				240	185
	½"	39CL400-DN	.76	1.40	.55	1 ¾"	.47	5.91	.25					
	¼"	39CL500-D141	.83	1.54	.51	3/4"	.43	4.70	.25					
750 MCM 400mm ²	¾"	39CL500-D38	.83	1.54	.51	1"	.43	4.96	.41	240				240
	½"	39CL500-DN	.83	1.54	.55	1 ¾"	.47	5.94	.52					
	¾"	39CL600-D38	.93	1.73	.79	1"	.43	3.90	.52					
750 MCM 400mm ²	½"	39CL600-DN	.93	1.73	.79	1 ¾"	.47	5.89	.41		-			300
	¾"	39CL750-DN38	1.02	1.89	.79	1 ¾"	.43	6.83	.41					
	¾"	39CL750-D38	1.02	1.89	.79	1"	.43	6.08	.41					
750 MCM 400mm ²	½"	39CL750-DN	1.02	1.89	.79	1 ¾"	.47	6.95	.52			-		400







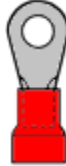

Information subject to change without notice; Dies shown above are metric sized.

*Color-coded crimp terminals are only marked for use with class B and C cable

Power Crimp (Solderless) Terminals

A wide range of crimp terminals (ring, spade, flat) for wires between 8AWG (10mm²) and 3/0AWG (95mm²), both non-insulated and nylon insulated. They feature **brazed seams** or **tubular construction**.

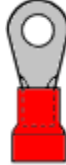
Power Crimp Terminals (Order by Part No.)

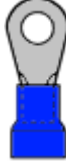
Wire section AWG mm ²	RING (LUG) TERMINALS							
	Stud Size	Part No. (brazed)	Part No. (tubular)		Part No. (nylon insulated)		Pack	Tool
8AWG 10mm ²	8	301.040	391.040		351.540		50	
	10	301.041	391.041		351.541			
	¼"	301.042	391.042		351.542			
	5/16"	301.043	391.043		351.543			
	3/8"	301.044	391.044		351.544			
	½"	301.045	391.045		351.545			
	9/16"	—	391.046		351.546			
6AWG 16mm ²	8	301.050	—		—		50	
	10	301.051	391.051		351.551		50	
	¼"	301.052	391.052		351.552		50	
	5/16"	301.053	391.053		351.553		50	
	3/8"	301.054	391.054		351.554		50	
	½"	301.055	391.055		351.555		50	
	9/16"	—	391.056		351.556		50	
	5/8"	—	391.057		351.557		50	
¾"	—	391.058	351.558	50				
4AWG 25mm ²	8	301.060	391.060		—		50	Non-insulated 12-14AWG 500.055 8-2AWG 500.038 6AWG - 4/0 500.620
	10	301.061	391.061		351.561		50	
	¼"	301.062	391.062		351.562		50	
	5/16"	301.063	391.063		351.563		50	
	3/8"	301.064	391.064		351.564		50	
	½"	301.065	391.065		351.565		50	
	9/16"	—	391.066		351.566		50	
	5/8"	—	391.067		351.567		50	
¾"	—	391.068	351.568	50				
2AWG 35mm ²	10	301.071	391.071		351.571		10	
	¼"	301.072	391.072		351.572		10	
	5/16"	301.073	391.073		351.573		10	
	3/8"	301.074	391.074		351.574		10	
	½"	301.075	391.075		351.575		10	
	9/16"	—	391.076		351.576		10	
	5/8"	—	391.077		351.577		10	
¾"	—	391.078	351.578	10				
1AWG 50mm ²	3/8"	—	391.084		—		10	
1/0AWG 55mm ²	¼"	301.092	391.092		351.592		10	
	5/16"	301.093	391.093		351.593		10	
	3/8"	301.094	391.094		351.594		10	
	½"	301.095	391.095		351.595		10	
	9/16"	301.096	391.096		351.596		10	
	5/8"	—	391.097		351.597		10	
	¾"	—	391.098		351.598		10	
7/8"	—	391.099	351.599	10				
3/0AWG 120mm ²	5/16"	—	391.013		—		10	

Information subject to change without notice

Wire section AWG mm ²	SPADE (FORK) TERMINALS							
	Stud Size	Part No. (brazed)	Part No. (tubular)		Part No. (nylon insulated)		Pack	Tool
8AWG 10mm ²	10	302.042	392.041		352.541		50	Non-insulated 12-14AWG 500.055 8-2AWG 500.038 6AWG - 4/0 500.620
	¼"	302.042	392.042		352.542			
8AWG 10mm ²	5/16"	—	392.043		—		50	
6AWG 16mm ²	10	—	392.051		—		50	
	¼"	302.052	392.052		352.552		50	
	5/16"	302.053	392.053		352.553		50	
6AWG 16mm ²	3/8"	—	392.054		—		50	
	½"	—	392.055		—		50	
4AWG 25mm ²	10	—	392.061		—		50	
	¼"	—	392.062		—		50	
	5/16"	—	392.063		—		50	
	3/8"	—	392.064		—		50	
	½"	—	392.065		—		50	
2AWG 35mm ²	5/16"	—	392.073		—		10	
1AWG 50mm ²	¼"	—	392.081		—		10	
	5/16"	—	392.083		—		10	
2/0AWG 70mm ²	5/16"	—	392.091		—		10	
Wire section AWG mm ²	FLAT TERMINALS (no CSA-UL)							
	Blade Length		Part No. (non-insulated)		Part No.		Pack	Tool
8AWG 10mm ²	11.5mm	—	393.241		—		50	8-4AWG 500.055
6AWG 16mm ²	14.5mm	—	393.251		—		50	
4AWG 25mm ²	15.5mm	—	393.261		—		50	
2AWG 35mm ²	18mm	—	393.271		—		10	
1AWG 50mm ²	20mm	—	393.281		—		10	6-0AWG 500.620
2/0AWG 70mm ²	23.5mm	—	393.291		—		10	
3/0AWG 95mm ²	27mm	—	393.301		—		5	500.630

Information subject to change without notice

Ferrules















Non-insulated Ferrules



Material: 99.9% electrolytic copper, tin plated RoHS

Dimensions according to DIN 46228 p1 (except where part number followed by *)

Non-insulated Ferrules (Order by Part No.)

AWG	mm ²	Part No.	Drawing	L2	d	D	Size	Pack	Tool
24	0.25	000.255*		5	0.8	1.7	N	500	See pages 27 & 28 for tools
		7		0.8	1.7	L	500		
22	0.50	000.506		6	1	2.1	S	500	
		8		1	2.1	N	500		
		10		1	2.1	L	500		
20	0.75	007.506		6	1.2	2.3	S	500	
		8		1.2	2.3	N	500		
		10		1.2	2.3	L	500		
18	1.00	001.006		6	1.4	2.7	S	500	
		10		1.4	2.7	N	500		
		12		1.4	2.7	L	500		
16	1.50	001.507		7	1.7	2.8	S	500	
		10		1.7	2.8	N	500		
		12		1.7	2.8	L	500		
		18		1.7	2.8	XL	500		
14	2.50	002.507		7	2.2	3.4	S	500	
		10		2.2	3.4	N	500		
		12		2.2	3.4	L	500		
		18		2.2	3.4	XL	500		
12	4.00	004.009		9	2.8	4.0	S	500	
		12		2.8	4.0	N	500		
		18		2.8	4.0	L	500		
10	6.00	006.010		10	3.5	4.7	S	100	
		12		3.5	4.7	N	100		
		15		3.5	4.7	L	100		
		18		3.5	4.7	XL	100		
8	10.00	010.012		12	4.5	5.8	S	100	
		15		4.5	5.8	N	100		
		18		4.5	5.8	L	100		
6	16.00	016.012		12	5.9	7.5	S	100	
		15		5.9	7.5	N	100		
		16		5.9	7.5	N	100		
		18		5.9	7.5	L	100		
		25		5.9	7.5	XL	100		
4	25.00	025.015		15	7.3	9.5	N	50	
		18		7.3	9.5	L	50		
		25		7.3	9.5	XL	50		
2	35.00	035.018		18	8.3	11.0	S	50	
		25		8.3	11.0	N	50		
		32		8.3	11.0	L	50		
1	50.00	050.018		18	10.3	13.0	N	50	
		25		10.3	13.0	L	50		
		32		10.3	13.0	XL	50		
2/0	70.00	070.025*		25	12.5	15.0	—	50	
3/0	95.00	095.030*		30	14.5	17.0	—	25	
4/0	120.0	020.034*		32	16.5	19.0	—	25	
300MCM	150.0	050.038*		32	21.0	24.0	—	50	
350MCM	185.0	085.032*		32	20.0	23.5	—	25	
500MCM	240.0	040.040*		40	22.8	25.8	—	25	

Information subject to change without notice - All dimensions in mm except where otherwise stated
Dimensions according to DIN 46228/1 except where part numbers followed by *

Single Insulated Ferrules

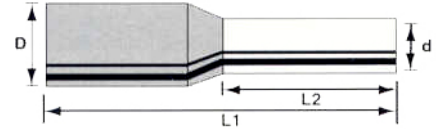

Material: 99.9% electrolytic copper, tin plated RoHS
Insulation: polypropylene or polyamide (Nylon). Available in 3 colour codes
 Dimensions according to DIN 46228/1 (except where part numbers followed by *)

Insulated Ferrules (Order by Part No.)

AWG	mm ²	Part No.			Drawing	L1	L2	d	D	Size	Pack	Tool
		DIN Colour Code	"W" Colour Code	"T" Colour Code								
26	0.14	-	900.146*	-		10.0	6	0.8	2.0	N	500	See pages 28 & 29 for tools
24	0.25	100.256* 100.258*	900.256* 900.258*	800.256* 800.258*		10.0 12.0	6 8	0.8 0.8	2.0 2.0	N L	500 500	
23	0.34	-	900.306* 900.308*	800.306* -		10.0 12.0	6 8	0.8 0.8	2.0 2.0	N L	500 500	
22	0.50	100.506 100.508 100.510	900.506 900.508 900.510	100.506 100.508 100.510		12.0 14.0 16.0	6 8 10	1.1 1.1 1.1	2.4 2.4 2.4	S N L	500 500 500	
20	0.75	107.506 107.508 107.510 107.512	907.506 907.508 907.510 907.512	807.506 807.508 807.510 807.512		12 14 16 18	6 8 10 12	1.3 1.3 1.3 1.3	2.7 2.7 2.7 2.7	S N L LL	500 500 500 500	
18	1.00	101.006 101.008 101.010 101.012	901.006 901.008 901.010 901.012	101.006 101.008 101.010 101.012		12.0 14.0 16.0 18.0	6 8 10 12	1.5 1.5 1.5 1.5	3.0 3.0 3.0 3.0	S N L LL	500 500 500 500	
16	1.50	101.508 101.510 101.512 101.518	901.508 901.510 901.512 901.518	101.508 101.510 101.512 101.518		14 16 18 24	8 10 12 18	1.8 1.8 1.8 1.8	3.4 3.4 3.4 3.4	N L LL XL	500 500 500 500	
14	2.50	102.508 102.512 102.518	902.508 902.512 902.518	802.508 802.512 802.518		15 17 25	8 12 18	2.3 2.3 2.3	4.2 4.2 4.2	N L LL	500 500 500	
12	4.00	104.009 104.012 104.018	904.009 904.012 904.018	804.009 804.012 804.018		17 19 26	10 12 18	2.9 2.9 2.9	5.2 5.2 5.2	N L LL	100 100 100	
10	6.00	106.012 106.018	906.012 906.018	806.012 806.018		20 26	12 18	3.6 3.6	6.2 6.2	N L	100 100	
8	10.00	110.012 110.018	910.012 910.018	810.012 810.018		21 27	12 18	4.6 4.6	7.5 7.5	N L	100 100	
6	16.00	116.012 116.018	916.012 916.018	816.012 816.018		23 28	12 18	5.6 5.6	8.8 8.8	N L	100 100	
4	25.00	125.016 125.022	925.016 925.022	825.016 825.022		30 35	16 22	7.8 7.8	12.0 12.0	N L	50 50	
2	35.00	135.016 135.025	935.016 935.025	835.016 835.025		30 36	18 25	8.3 8.3	13.5 13.5	N L	50 50	
1	50.00	150.020 150.025	950.020 950.025	850.020 850.025		36 40	20 25	10.3 10.3	16.0 16.0	N L	50 50	
2/0	70.00	-	-	870.020* 870.027*		37 44	20 27	12.7 12.7	16.0 16.0	N	50	
3/0	95.00	-	-	895.025*		44	25	14.7	18.0	N	25	
4/0	120.0	-	-	820.027*		48	27	16.7	21.0	N	25	
300 MCM	150.0	-	-	850.032*		58	32	19.7	23.0	N	25	







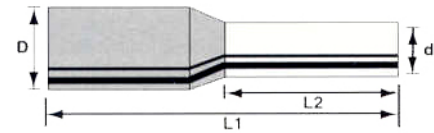

Information subject to change without notice - All dimensions in mm except where otherwise stated
 * Dimensions according to DIN 46228/1 except where part numbers followed by *

Twin Insulated Ferrules

Material: 99.9% electrolytic copper, tin plated RoHS
Insulation: polypropylene.
Dimensions according to DIN 46228/1



Twin Insulated Ferrules (Order by Part No.)





AWG	mm ²	Part No.	Drawing	L1	L2	d	WxD	Size	Pack	Tool
2 x 22	2 x 0.50	200.508		15	8	1.5	2.3 x 4.5	N	500	See pages 28 & 29 for tools
2 x 20	2 x 0.75	207.508		15	8	1.8	2.7 x 5.4	N	500	
	2 x 0.75	207.510		17	10	1.8	2.7 x 5.4	L	500	
2 x 18	2 x 1.00	201.008		15	8	2.05	3.3 x 5.3	N	500	
		201.010		17	10	2.05	3.3 x 5.3	L	500	
2 x 16	2 x 1.50	201.508		16	8	2.3	3.5 x 6.5	N	500	
		201.512		20	12	2.3	3.5 x 6.5	L	500	
2 x 14	2 x 2.50	202.510		18.5	10	2.9	4.1 x 7.7	N	250	
		202.513		21.5	13	2.9	4.1 x 7.7	L	250	
2 x 12	2 x 4.00	204.012		23	12	3.8	4.9 x 8.7	N	100	
2 x 10	2 x 6.00	206.014		25	14	4.9	6.1 x 5.9	N	100	
2 x 8	2 x 10.00	210.014		26	14	6.5	7.1 x 12.9	N	100	
2 x 6	2 x 16.00	216.014		31	16	8.5	8.8 x 16.8	N	50	

Information subject to change without notice - All dimensions in mm except where otherwise stated

Single Insulated Ferrules in Strips, Spools and Rolls

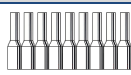
Material: 99.9% electrolytic copper, tin plated RoHS
Insulation: polypropylene or polyamide (Nylon). Available in DIN colour code only, other codes on special order
Dimensions according to DIN 46228/1 - (*) Special order only

Insulated Ferrules (Order by Part No.)

AWG	mm ²	Part No.	Drawing	L1	L2	d	D	Size	Pack	Tool
22	0.50	170.508		14.5	8.0	1.1	2.6	N	5 strips of 50 ferrules	500.090 503.000
22	0.50	090.508		14.5	8.0	1.1	2.6	N	1 spool of 1000 ferrules	
22	0.50	190.508		14.5	8.0	1.1	2.6	N	1 roll of 3000 ferrules*	
20	0.75	177.508		14.5	8.0	1.3	2.8	N	5 strips of 50 ferrules	
20	0.75	097.508		14.5	8.0	1.3	2.8	N	1 spool of 1000 ferrules	
20	0.75	197.508		14.5	8.0	1.3	2.8	N	1 roll of 3000 ferrules*	
18	1.00	171.008		14.5	8.0	1.5	3.0	N	5 strips of 50 ferrules	
		091.008		14.5	8.0	1.5	3.0	N	1 spool of 1000 ferrules	
		191.008		14.5	8.0	1.5	3.0	N	1 roll of 3000 ferrules*	
16	1.50	171.508		14.5	8.0	1.8	3.4	N	5 strips of 50 ferrules	
		091.508		14.5	8.0	1.8	3.4	N	1 spool of 1000 ferrules	
		191.508		14.5	8.0	1.8	3.4	N	1 roll of 2500 ferrules*	
14	2.50	172.508		14.5	8.0	2.3	4.2	N	5 strips of 50 ferrules	
		092.508		14.5	8.0	2.3	4.2	N	1 spool of 500 ferrules	
		192.508		14.5	8.0	2.3	4.2	N	1 roll of 1500 ferrules*	

Information subject to change without notice - All dimensions in mm except where otherwise stated

* Special order item

Short-Circuit Protection Insulated Ferrules

Ferrules specially designed with large plastic collars with extra thick insulation for short-circuit and earth fault protection (NSGAFÖU).

Material: 99.9% electrolytic copper, tin plated RoHS
Insulation: polyamide (nylon). Available in DIN colour code only

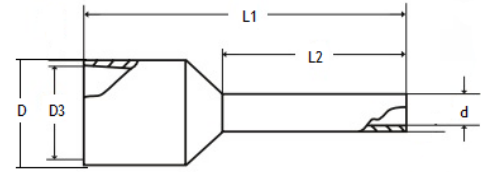

Insulated Ferrules (Order by Part No.)

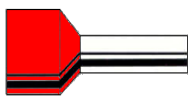
AWG	mm ²	DIN Colour Code	Drawing	L1	L2	d	D	D3	Size	Pack	Tool
16	1.50	101.598		17.5	8.0	1.8	7.2	6.9	N	100	See pages 28 & 29 for tools
14	2.50	102.598		17.5	8.0	2.3	8.1	7.8	N	100	
12	4.00	104.912		19.5	10.0	2.9	8.1	7.8	N	100	
10	6.00	106.912		23.0	12.0	3.6	8.6	8.3	N	100	
8	10.00	110.912		24.0	12.0	4.6	10.1	9.8	N	100	
6	16.00	116.912		25.5	12.0	6.0	12.3	12.0	N	100	

Information Subject to change without notice - All Dimensions in mm except where otherwise stated

Ferrule Dispenser Boxes

These small, handy round plastic boxes 90mm diameter (approx. 3 1/2"), are practical for everyday use, both in the shop and in the field.



Dispenser Boxes (Order by Part No.)

Part No.	Description	Contents		
		Wire size	Part No.	Quantity
199.001	Dispenser box Insulated ferrules DIN colour code	22AWG - 0.50mm ²	100.508	50
		20AWG - 0.75mm ²	107.508	100
		18AWG - 1mm ²	101.108	100
		16AWG - 1.5mm ²	101.508	100
		14AWG - 2.5mm ²	102.508	50
199.002	Dispenser box Insulated ferrules "W" colour code	22AWG - 0.50mm ²	900.508	50
		20AWG - 0.75mm ²	907.508	100
		18AWG - 1mm ²	901.008	100
		16AWG - 1.5mm ²	901.508	100
		14AWG - 2.5mm ²	102.508	50
199.003	Dispenser box Large insulated ferrules DIN colour code	12AWG - 4mm ²	104.009	50
		10AWG - 6mm ²	106.012	20
		8AWG - 10mm ²	110.012	20
		6AWG - 16mm ²	116.012	10
199.004	Dispenser box Large insulated ferrules "W" colour code	12AWG - 4mm ²	104.009	50
		10AWG - 6mm ²	906.012	20
		8AWG - 10mm ²	910.012	20
		6AWG - 16mm ²	906.012	10
199.031	Test box Very small insulated ferrules DIN colour code	24AWG - 0.25mm ²	100.256	30
		23AWG - 0.34mm ²	900.306	30
		22AWG - 0.50mm ²	100.508	30
		20AWG - 0.75mm ²	107.508	30
		18AWG - 1.0mm ²	101.008	30
199.032	Test box Very small insulated ferrules "W" colour code	24AWG - 0.25mm ²	900.256	30
		23AWG - 0.34mm ²	900.306	30
		22AWG - 0.50mm ²	900.508	30
		20AWG - 0.75mm ²	907.508	30
		18AWG - 1.0mm ²	901.008	30
199.033	Test box insulated twin ferrules DIN colour code	2x16 AWG - 2x1.5mm ²	201.508	20
		2x14 AWG - 2x2.5mm ²	202.510	20
		2x12 AWG - 2x4.0mm ²	204.012	20
		2x10 AWG - 2x6.0mm ²	206.014	10

Information subject to change without notice - All dimensions in mm except where otherwise stated

Ferrule Kits in Plastic or Metal Cases

ITC offers completed ferrule assortment kits in sturdy polypropylene or heavy-duty metal cases. Plastic cases have 12 compartments for ferrules plus one space for a crimping tool. Metal cases have 20 compartments for ferrules and space for one crimping tool.

Upon request, ITC can supply custom kits designed to suit your needs.

Ferrule Kits - Plastic Case (Order by Part No.)

Part No.	Description	Contents (ferrules)		
		Wire size	Part No.	Quantity
199.107	Plastic tool kit - Assortment of insulated and Twin ferrules DIN colour code with industrial tool 504.811 	22AWG - 0.50mm ²	100.508	250
		20AWG - 0.75mm ²	107.508	250
		18AWG - 1mm ²	101.008	250
		16AWG - 1.5mm ²	101.508	250
		14AWG - 2.5mm ²	102.508	100
		12AWG - 4mm ²	104.009	100
		10AWG - 6mm ²	106.012	50
		2x22AWG - 2x0.50mm ²	200.508	100
		2x20AWG - 2x0.75mm ²	207.508	100
		2x18AWG - 2x1mm ²	201.008	100
		2x16AWG - 2x1.5mm ²	201.508	100
		2x14AWG - 2x2.5mm ²	202.510	50
199.117	Plastic tool kit - Assortment of insulated and Twin ferrules DIN colour code with professional tool 500.049	Same as 199.107		
199.127	Plastic ferrule kit - Assortment of insulated and Twin ferrules DIN colour code without tool	Same as 199.107		
199.108	Plastic tool kit - Assortment of insulated ferrules DIN colour code with industrial tool 504.811	22AWG - 0.50mm ²	100.508	250
		20AWG - 0.75mm ²	107.508	250
		18AWG - 1mm ²	101.008	250
		16AWG - 1.5mm ²	101.508	250
		14AWG - 2.5mm ²	102.508	100
12AWG - 4mm ²	104.009	100		
199.118	Plastic tool kit - Assortment of insulated ferrules DIN colour code with professional tool 500.049	Same as 199.108		
199.128	Plastic ferrule kit - Assortment of insulated ferrules DIN colour code without tool	Same as 199.108		



500.049

Information subject to change without notice

Ferrule Kits - Metal Case (Order by Part No.)

Part No.	Description	Contents (ferrules)		
		Wire size	Part No.	Quantity
199.109	Metal Tool kit - Assortment of insulated and Twin ferrules DIN colour code with industrial tool 504.811 	22AWG - 0.50mm ²	100.508	250
		20AWG - 0.75mm ²	107.508	500
		18AWG - 1mm ²	101.008	500
		16AWG - 1.5mm ²	101.508	500
		14AWG - 2.5mm ²	102.508	250
		12AWG - 4mm ²	104.009	100
		10AWG - 6mm ²	106.012	100
		2x22AWG - 2x0.50mm ²	200.508	100
		2x20AWG - 2x0.75mm ²	207.508	100
		2x18AWG - 2x1mm ²	201.008	100
		2x16AWG - 2x1.5mm ²	201.508	100
		2x14AWG - 2x2.5mm ²	202.510	50
		2x12AWG - 2x4mm ²	204.012	50
		2x10AWG - 2x6mm ²	206.014	25
		199.119	Metal tool kit - Assortment of insulated and Twin ferrules DIN colour code with professional tool 500.049	Same as 199.109
199.129	Metal Ferrule kit - Assortment of insulated and Twin ferrules DIN colour code without tool	Same as 199.109		



504.811

Information subject to change without notice

Ferrule Slide-Box Kits

A handy, attractive package for displaying and using small components such as wire terminals, ferrules, etc..

Case made of impact-resistant thermoplastic resin in eight available colours. Covers in transparent plastic, to show contents of each compartment. Covers slide easily with thumb action, yet single compartments are safely closed until needed.

Designed to hang on standard display hooks. Available empty or in prepared kits of ferrules.



Ferrule Slide-Box Kits (Order by Part No.)

Part No.	Description	Compartment 1	Compartment 2	Compartment 3	Compartment 4	Compartment 5
199.051	Empty slide-box					
199.053	Empty slide-box					
199.054	Empty slide-box					
199.055	Empty slide-box					
199.056	Empty slide-box					
199.057	Empty slide-box					
199.058	Empty slide-box					
199.059	Empty slide-box					
790.130	Insulated Ferrules 22-14AWG	100 ferrules 22AWG white	100 ferrules 20AWG grey	100 ferrules 18AWG red	50 ferrules 16AWG black	50 ferrules 14AWG blue
790.131	Non-insulated Ferrules 22-14AWG	100 ferrules 22AWG	100 ferrules 20AWG	100 ferrules 18AWG	100 ferrules 16AWG	50 ferrules 14AWG
790.132	Twin Ins. Ferrules 22-14AWG	50 twin ferrules 22AWG white	50 twin ferrules 20AWG grey	50 twin ferrules 18AWG red	50 twin ferrules 16AWG black	25 twin ferrules 14AWG blue
790.133	Insulated Ferrules 14-6AWG	50 ferrules 14AWG blue	30 ferrules 12AWG grey	25 ferrules 10AWG yellow	20 ferrules 8AWG red	15 ferrules 6AWG blue

Information subject to change without notice



Crimping Tools for Solderless Terminals and Ferrules











ITC offers a wide variety of crimping tools and machines for all the crimp terminals and ferrules in this catalog. All ITC tools come with one-year warranty covering manufacturing defects.

Manual Crimping Tools for Solderless Crimp Terminals and Power Connectors (Order by Part No.)

	Part No. Range AWG	Insulated/non-Insulated	Part No. Range AWG	
	500.038 8-2	Rotating die tool for non-insulated power		
		Professional tool PEW 8 for insulated crimp terminals	500.064 22-10	
	500.620 6-4/0	Single die heavy duty crimping tool for non-insulated crimp terminals		
		Crimping tool - Series 800 for insulated crimp terminals	500.821 20-10	
	500.825 20-10	Series 800; insulated closed end crimp terminals		
		Non-Insulated open barrel crimp terminals	500.842 20-10	
	501.334 20-14	PEW 12; non-Insulated flag crimp terminals		
		PEW12; non-Insulated flag crimp terminals	501.335 17-10	
	502.551K 8-240MCM	Hydraulic crimping tool 240R; 5.3tons/52kN; for lugs; case; no dies		
		Hydraulic crimping tool H-4413; 12.7 tons/125kN; 44mm jaw for lugs; case; no dies	502.771K 6-400MCM	
	504.821 26-18	CS8; insulated terminals		
		CS8; non-insulated crimp terminals	504.842 24-14	
	504.921 22-10	CS9; insulated crimp terminals		
		CS9; insulated flag terminals	504.923 18-14	
	504.925 22-10	CS8; Insulated closed end crimp terminals		
		CS9; Non-insulated, open barrel crimp terminals	504.931 22-10	
	504.942 22-10	CS9; non-insulated, open barrel crimp terminals		
		CS10 crimping tool kit for insulated crimp terminals, insulated disconnects, insulated and non-insulated ferrules and closed end connectors	500.068 22-1*	

Information subject to change without notice
* range dependent on terminal type









Manual Crimping Tools for Ferrules (Order by Part No.)

	Part No. Range AWG	Insulated/non-Insulated	Part No. Range AWG	
	500.035 28-8	PEW 8.84 Professional square die; ferrules		
		PEW 8.86 Professional hex die; ferrules	500.039 28-10	
	500.049 28-6	PEW 8.88 Professional front-load square die; ferrules		
	Jokari QUADRO multiple tool with case & magazines, cuts, strips, twists stranded wire and crimps		500.090 22-14	
	504.811 20-10	CS8; ferrules		
		CS8; ferrules	504.812 10-6	
	504.911 22-8	CS9; ferrules		
		CS9; ferrules	504.912 10-6	
	504.913 4-1	CS9; ferrules		
		CS9; ferrules	504.914 8-2	

Information subject to change without notice



Electric/Pneumatic Crimping Machines(Order by Part No.)

	Part No. Range AWG	Insulated/non-Insulated	Part No. Range AWG	
	503.000 22-14	Automatic electric stripper/crimper MC 25 for ferrules 0.5-2.5 mm ² , complete with all dies		
		Automatic electro-pneumatic stripper/crimper MC40-1 for ferrules	503.040 22-16 503.040L 12-8	
	500.920 27-8*	Pneumatic bench-mount crimp tool model AM30, with footswitch/hose for ferrules and power crimp connectors		
		Automatic Bench-mount crimp machine EC 65 for ferrules and power crimp connectors	503.065 28-1	
	500.951 24-14 500.961 12-8	AC 25T & AC100T pneumatic crimp tools; holder, hose and foot switch for ferrules		
		Pneumatic hand held crimp tool for ferrules	500.952 24-14	

Information subject to change without notice
* range dependent on terminal type

Note on crimping:

Crimping tools for solderless terminals must compress the whole length of the terminal's "barrel" without damaging the individual strands of the conductor and without breaking the terminal itself.

Some terminals require multiple crimp operations.

The conductor shall be secured that it shall not be pulled out of the crimped terminal.

The tool used for crimping terminals must match the type of terminal which must be crimped, both in type and in wire gauge.

AWG to Metric Equivalent (Wire Diameters)

AWG/MCM to mm²

AWG	mm ²
30	0.05
28	0.08
26	0.14
24	0.25
22	0.34
21	0.38
20	0.50
18	0.75
17	1.0
16	1.5
14	2.5
12	4.0
10	6.0
8	10
6	16
4	25
3	27
2	35
1	50
1/0	55
2/0	70
3/0	95
4/0	120
250MCM	127
300MCM	150
350MCM	185
400MCM	203
500MCM	240
600MCM	300
750MCM	400
1000MCM	500

mm² to AWG/MCM

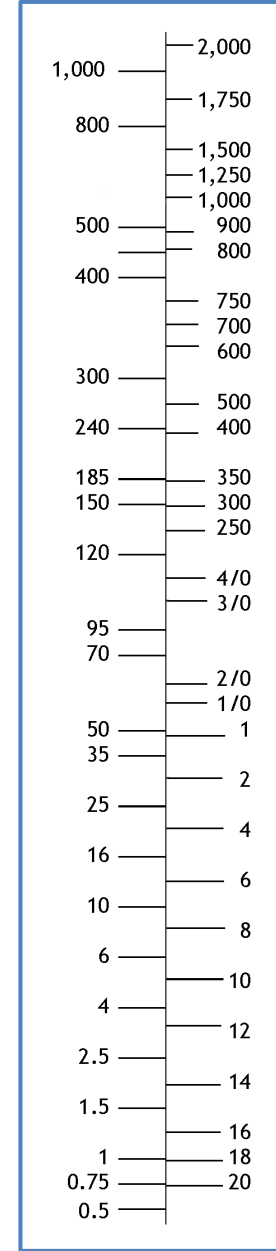

Note: the values in these tables are given as a guide only. Actual diameters may be different depending on stranding and other construction details. The diameter of a solid and stranded wire with the same AWG is not identical.



ELECTRICAL COMPONENTS



416.663.7223



www.itcproducts.com



50 Mural St Unit 8
Richmond Hill, ON L4B 1E4



DIN Rail



DIN Rail Accessories



Hinged Enclosures



Thermal Management



PANEL Lighting



Multipole Connectors



Plug and Socket Connectors



Terminal Blocks

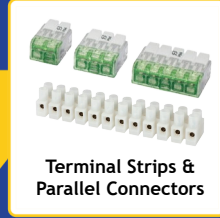

Terminal Strips & Parallel Connectors



Interface Connectors



Pushbuttons & Control Stations



Led Light bulbs & Pilot Lights



Limit Switches



Micro Limit Switches



Safety Switches



Foot Switches



Circuit Breakers



Contactors & Starters



Variable Frequency Drives

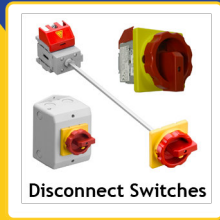

Disconnect Switches



Fuses & Fuse Holders



Tower Lights & Signalling Devices



Power Continuity



Ferrules



Colour Coded Lugs



Crimp Terminals

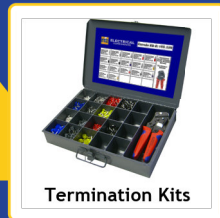

Termination Kits



Cable Glands



Thread Adapters



Cable Entry Systems



Wire Management



DIN Rail Cutters



Assembly Tables



Cutting & Stripping



Crimping Tools



Hole Cutting & Punching Tools

SOME OF OUR MANUFACTURING PARTNERS

bimed

df Electric

DSE

ALFRA

COMEPI

ILME

TEKNIC ELECTRIC

DETASULTRA

sontheimer